



Audio Plug-Ins Guide

Version 12.2

Legal Notices

© 2015 Avid Technology, Inc., ("Avid"), all rights reserved. This guide may not be duplicated in whole or in part without the written consent of Avid.

003, 192 Digital I/O, 192 I/O, 96 I/O, 96i I/O, Adrenaline, AirSpeed, ALEX, Alienbrain, AME, AniMatte, Archive, Archive II, Assistant Station, AudioPages, AudioStation, AutoLoop, AutoSync, Avid, Avid Active, Avid Advanced Response, Avid DNA, Avid DNxcel, Avid DNxHD, Avid DS Assist Station, Avid Ignite, Avid Liquid, Avid Media Engine, Avid Media Processor, Avid MEDIArray, Avid Mojo, Avid Remote Response, Avid Unity, Avid Unity ISIS, Avid VideoRAID, AvidRAID, AvidShare, AVIDStripe, AVX, Beat Detective, Beauty Without The Bandwidth, Beyond Reality, BF Essentials, Bomb Factory, Bruno, C|24, CaptureManager, ChromaCurve, ChromaWheel, Cineractive Engine, Cineractive Player, Cineractive Viewer, Color Conductor, Command|8, Control|24, Cosmonaut Voice, CountDown, d2, d3, DAE, D-Command, D-Control, Deko, DekoCast, D-Fi, D-fx, Digi 002, Digi 003, DigiBase, Digidesign, Digidesign Audio Engine, Digidesign Development Partners, Digidesign Intelligent Noise Reduction, Digidesign TDM Bus, DigiLink, DigiMeter, DigiPanner, DigiProNet, DigiRack, DigiSerial, DigiSnake, DigiSystem, Digital Choreography, Digital Nonlinear Accelerator, DigiTest, DigiTranslator, DigiWear, DINR, DNxchange, Do More, DPP-1, D-Show, DSP Manager, DS-StorageCalc, DV Toolkit, DVD Complete, D-Verb, Eleven, EM, Euphonix, EUCON, EveryPhase, Expander, ExpertRender, Fairchild, FastBreak, Fast Track, Film Cutter, FilmScribe, Flexevent, FluidMotion, Frame Chase, FXDeko, HD Core, HD Process, HDpack, Home-to-Hollywood, HyperSPACE, HyperSPACE HDCAM, iKnowledge, Impact, Improv, iNEWS, iNEWS Assign, iNEWS ControlAir, InGame, Instantwrite, Instinct, Intelligent Content Management, Intelligent Digital Actor Technology, IntelliRender, Intelli-Sat, Intelli-Sat Broadcasting Recording Manager, InterFX, Interplay, inTONE, Intraframe, iS Expander, iS9, iS18, iS23, iS36, ISIS, IsoSync, LaunchPad, LeaderPlus, LFX, Lightning, Link & Sync, ListSync, LKT-200, Lo-Fi, MachineControl, Magic Mask, Make Anything Hollywood, make manage move|media, Marquee, MassivePack, MassivePack Pro, Maxim, Mbox, Media Composer, MediaFlow, MediaLog, MediaMix, Media Reader, Media Recorder, MEDIArray, MediaServer, MediaShare, MetaFuze, MetaSync, MIDI I/O, Mix Rack, Moviestar, MultiShell, NaturalMatch, NewsCutter, NewsView, NewsVision, Nitris, NL3D, NLP, NSDOS, NSWIN, OMF, OMF Interchange, OMM, OnDVD, Open Media Framework, Open Media Management, Painterly Effects, Palladium, Personal Q, PET, Podcast Factory, PowerSwap, PRE, ProControl, ProEncode, Profiler, Pro Tools, Pro Tools|HD, Pro Tools LE, Pro Tools M-Powered, Pro Transfer, QuickPunch, QuietDrive, Realtime Motion Synthesis, Recti-Fi, Reel Tape Delay, Reel Tape Flanger, Reel Tape Saturation, Reprise, Res Rocket Surfer, Reso, RetroLoop, Reverb One, ReVibe, Revolution, rS9, rS18, RTAS, Salesview, Sci-Fi, Scorch, ScriptSync, SecureProductionEnvironment, Shape-to-Shape, ShuttleCase, Sibelius, SimulPlay, SimulRecord, Slightly Rude Compressor, Smack!, Soft SampleCell, Soft-Clip Limiter, SoundReplacer, SPACE, SPACESHift, SpectraGraph, SpectraMatte, SteadyGlide, Streamfactory, Streamgenie, StreamRAID, SubCap, Sundance, Sundance Digital, SurroundScope, Symphony,

SYNC HD, SYNC I/O, Synchronic, SynchroScope, Syntax, TDM FlexCable, TechFlix, Tel-Ray, Thunder, TimeLiner, Titansync, Titan, TL Aggro, TL AutoPan, TL Drum Rehab, TL Everyphase, TL Fauxlder, TL In Tune, TL MasterMeter, TL Metro, TL Space, TL Utilities, tools for storytellers, Transit, TransJammer, Trillium Lane Labs, TruTouch, UnityRAID, Vari-Fi, Video the Web Way, VideoRAID, VideoSPACE, VTEM, Work-N-Play, Xdeck, X-Form, and XMON are either registered trademarks or trademarks of Avid Technology, Inc. in the United States and/or other countries.

Bonjour, the Bonjour logo, and the Bonjour symbol are trademarks of Apple Computer, Inc.

Thunderbolt and the Thunderbolt logo are trademarks of Intel Corporation in the U.S. and/or other countries.

This product may be protected by one or more U.S. and non-U.S. patents. Details are available at www.avid.com/patents.

Product features, specifications, system requirements, and availability are subject to change without notice.

Guide Part Number 9329-65623-00 REV A 8/15

Contents

Part I Introduction to Audio Plug-Ins

Chapter 1. Audio Plug-Ins Overview	2
Plug-In Formats	2
Avid Audio Plug-Ins	2
Using Plug-Ins in Pro Tools	4
Avid Application Manager	4
Conventions Used in Pro Tools Documentation	5
System Requirements and Compatibility for Plug-Ins	5
About www.avid.com	6
Chapter 2. Installing and Authorizing Avid Plug-Ins	7
About iLok	7
Authorizing Avid Audio Plug-Ins	7
Installing Plug-Ins for Pro Tools and Media Composer	8
Installing Plug-Ins from the Avid Marketplace	8
Removing Plug-Ins	8
Chapter 3. Adjusting Plug-In Controls	9
Dragging Plug-In Controls	9
Editing Control Values	10
Dragging in Graphic Displays	10
Adjusting Controls with Fine Resolution	10
Resetting Controls to Default Values	10

Part II EQ Plug-Ins

Chapter 4. EQ III	12
EQ III Configurations	12
Adjusting EQ III Controls	13
EQ III I/O Controls	15
EQ III EQ Band Controls	16
1-Band EQ III	17
7-Band EQ III	20
Chapter 5. Focusrite D2	26
D2 Configurations	26
D2 Controls	27
Using D2 in Stereo	31
Chapter 6. JOEMEEK VC5 Meequalizer	32
JOEMEEK Meequalizer Controls	32
Chapter 7. Pultec Plug-Ins	33
Pultec EQP-1A	33
Pultec EQH-2	34
Pultec MEQ-5	34
Pultec Tips and Tricks	35

Part III Dynamics Plug-Ins

Chapter 8. BF-2A	37
BF-2A Controls	38
Using the BF-2A Side-Chain Filter	38
BF-2A Tips and Tricks	39
Chapter 9. BF-3A	40
BF-3A Controls	40
BF-3A Tips and Tricks	41
Chapter 10. BF76	42
BF76 Controls	42
BF76 Tips and Tricks	43

Chapter 11. Channel Strip	44
Channel Strip Sections and Panes	45
Channel Strip Input Section	47
Channel Strip Output Section	48
Channel Strip FX Chain	49
Channel Strip Dynamics Section	49
Channel Strip EQ/Filters Section	55
Chapter 12. Dynamics III	59
Dynamics III Common Controls	59
Compressor/Limiter III	62
Expander/Gate III	65
De-Esser III	68
Dynamics III Side-Chain Input	70
Chapter 13. Fairchild Plug-Ins	75
Fairchild 660	75
Fairchild 670	77
Chapter 14. Focusrite D3	78
D3 Compressor	78
D3 Limiter	79
D3 Side-Chain Processing	79
Using D3 in Stereo	79
D3 Common Controls	80
D3 Compressor Controls	81
D3 Limiter Controls	83
Using the Side-Chain Input in D3	84
Chapter 15. Impact	85
Impact Controls	85
Using the Impact Compressor	87
Chapter 16. JOEMEEK SC2 Compressor	89
JOEMEEK Compressor Controls	89
JOEMEEK Compressor Tips and Tricks	90

Chapter 17. Maxim	91
About Peak Limiting	92
How Maxim Differs From Conventional Limiters	93
Maxim Controls and Meters	93
Using Maxim	96
Maxim and Mastering	96
Chapter 18. Pro Compressor	97
Pro Compressor Metering	97
Pro Compressor Input Section	98
Pro Compressor Output Section	99
Pro Compressor Dynamics Graph	100
Pro Compressor Controls	102
Pro Compressor Side-Chain Processing	104
Chapter 19. Pro Expander	107
Pro Expander Metering	107
Pro Expander Input Section	108
Pro Expander Output Section	109
Pro Expander Dynamics Graph	109
Pro Expander Controls	112
Pro Expander Side-Chain Processing	114
Chapter 20. Pro Limiter	117
Pro Limiter Metering	118
Pro Limiter Input Section	118
Pro Limiter Output Section	120
Pro Limiter Controls	120
Pro Limiter Loudness Numeric Displays	122
Pro Limiter Histogram and Loudness Meters	122
AudioSuite Processing with Pro Limiter	123
AudioSuite Processing with Pro Limiter Loudness Analyzer	124

Chapter 21. Pro Multiband Dynamics	125
FFT Display and Controls	126
Input and Output Gain Controls	128
Source Linking	128
Mini Multichannel Gain Reduction and Output Meters	129
Band Pane Controls and Indicators	130
Side-Chain Processing	134
Multiband Splitter Plug-In	135
Pro Multiband Dynamics and Multiband Splitter Plug-In Sends	135
Chapter 22. Purple Audio MC77	136
Purple Audio MC77 Controls	136
Chapter 23. Smack!	137
Smack! Controls and Meters	138
Using the Smack! Side-Chain Input	142
Part IV Pitch and Time Shift Plug-Ins	
Chapter 24. Pitch II	144
Pitch II Controls	145
Chapter 25. Time Shift	148
Time Shift Controls	148
AudioSuite Input Modes and Time Shift	153
AudioSuite Preview and Time Shift	153
Time Shift as AudioSuite TCE Plug-In Preference	153
Processing Audio Using Time Shift	153
Post Production Pull Up and Pull Down Tasks with Time Shift	155
Chapter 26. Vari-Fi	156
Vari-Fi Controls	156
Chapter 27. X-Form	158
X-Form Displays and Controls Overview	158
X-Form AudioSuite Input Modes	162
\AudioSuite TCE Plug-In Preference	162
Processing Audio Using X-Form	163
Using X-Form for Post Production Pull Up and Pull Down Tasks	164

Part V Reverb Plug-Ins

Chapter 28. D-Verb	166
D-Verb Controls	166
Selections for D-Verb AudioSuite Processing	168
Chapter 29. Reverb One	169
About Reverb	170
Reverb One Controls	171
Reverb One Graphs	175
Other Reverb One Controls	177
Chapter 30. ReVibe II	178
Using ReVibe II	178
Dragging in the Graphic Display to Adjust Controls	179
ReVibe II Input and Output Meters	180
ReVibe II Controls	180
ReVibe II Decay EQ Graph	186
ReVibe II Decay Color Graph	186
ReVibe II Contour Display	187
ReVibe II Room Types	188
Chapter 31. Space	192
Space Feature Highlights	193
Space Overview	194
Impulse Response (IR) and Space	198
Space Presets	201
Space Snapshots	201
Space Controls and Displays	202
Space Display Area	203
Space IR Browser	206
Space Primary Controls	208
Space Group Selectors and Controls	209
Using Space	212
Space IR Library Categories	213

Part VI Delay Plug-Ins

Chapter 32. Mod Delay III	215
Mod Delay III Controls	215
Selections for Mod Delay III AudioSuite Processing	217
Chapter 33. Moogerfooger Analog Delay	218
Moogerfooger Analog Delay Controls	219
Moogerfooger Analog Delay Tips and Tricks	219
Chapter 34. Reel Tape Delay	220
Reel Tape Common Controls	221
Reel Tape Delay Controls	221
Synchronizing Reel Tape Delay to Session Tempo	223
Reel Tape Delay Presets	223
Chapter 35. Tel-Ray Variable Delay	224
Tel-Ray Controls	225
Tel-Ray Tips and Tricks	225
Chapter 36. TimeAdjuster	226
TimeAdjuster Controls	226
Using TimeAdjuster for Manual Delay Compensation	227
When to Compensate for Delays	228

Part VII Modulation Plug-Ins

Chapter 37. Moogerfooger Lowpass Filter	230
Moogerfooger Lowpass Filter Controls	231
Moogerfooger Lowpass Filter Tips and Tricks	232
Chapter 38. Moogerfooger 12-Stage Phaser	233
Moogerfooger 12-Stage Phaser Controls	234
Moogerfooger 12-Stage Phaser Tips and Tricks	235
Chapter 39. Moogerfooger Ring Modulator	236
Moogerfooger Ring Modulator Controls	237
Moogerfooger Ring Modulator Tips and Tricks	237

Chapter 40. Reel Tape Flanger	238
Reel Tape Common Controls	239
Reel Tape Flanger Controls	239
Synchronizing Reel Tape Flanger to Session Tempo	241
Reel Tape Flanger Tips	242
Reel Tape Flanger Presets	242
Chapter 41. Sci-Fi	243
Sci-Fi Controls	243
Chapter 42. Voce Plug-Ins	246
Voce Chorus/Vibrato	246
Voce Spin	247
Part VIII	Harmonic Plug-Ins
Chapter 43. Aphex Aural Exciter Type III	252
Meters	254
Rotary Controls	254
Switches	256
Using Aural Exciter III	258
Chapter 44. Aphex Big Bottom Pro	261
Meters	262
Rotary Controls	263
Switches	263
Using Big Bottom Pro	265
Chapter 45. Eleven	266
Eleven Input Calibration and QuickStart	268
Using Eleven	272
Eleven Tips and Suggestions	289
Eleven Signal Flow Notes	291
Chapter 46. Lo-Fi	292
Lo-Fi Controls	292

Chapter 47. Pro Subharmonic	294
Metering	295
Input	295
Output	296
Dynamic Frequency Display	296
High Pass and Low Pass Filter Controls	297
Subharmonic Frequency Range	298
Lower, Upper, and Direct Gain Controls	299
Drive	300
Mix Controls	301
Surround Send Controls	302
Tuning Subharmonics with MIDI	303
Chapter 48. Recti-Fi	305
Recti-Fi Controls	305
Chapter 49. Reel Tape Saturation	308
Reel Tape Common Controls	308
Reel Tape Saturation Controls	309
Reel Tape Saturation Tips	310
Reel Tape Saturation Presets	310
Chapter 50. SansAmp PSA-1	311
PSA-1 Controls	312
PSA-1 Tips and Tricks	312
Part IX	Dither Plug-Ins
Chapter 51. Dither	314
Dither Controls	314
Chapter 52. POW-r Dither	316
POW-r Dither Controls	316

Part X Sound Field Plug-Ins

Chapter 53. AutoPan	319
AutoPan Controls	319
Using AutoPan	324
Chapter 54. Down Mixer	326
Source	327
Downmix	327

Part XI Instrument Plug-Ins

Chapter 55. Click II	329
Click II Controls and Displays	329
Creating a Click Track	331
Chapter 56. ReWire	332
ReWire Requirements	334
Using ReWire	335
MIDI Automation with ReWire	336
Quitting ReWire Client Applications	338
Session Tempo and Meter Changes and ReWire	338
Looping Playback with ReWire	339
Automating Input Switching with ReWire	339

Part XII Other Plug-Ins

Chapter 57. InTune	341
InTune Controls and Displays	342
InTune Presets	344
Using InTune	345
Chapter 58. MasterMeter	347
MasterMeter Overview	348
Using MasterMeter	351
MasterMeter Controls and Displays	352
Chapter 59. Signal Generator	355
Signal Generator Controls	355
AudioSuite Processing with Signal Generator	356

Chapter 60. SoundReplacer	357
Audio Replacement Techniques	357
SoundReplacer Controls.	358
Using SoundReplacer.	361
Getting Optimum Results with SoundReplacer.	362
Using the Audio Files Folder for Frequently Used SoundReplacer Files	364
Chapter 61. Time Compression/Expansion	365
Time Compression/ Expansion Controls	365
Chapter 62. Trim	367
Trim Controls.	367
Chapter 63. Other AudioSuite Plug-In Utilities	368
DC Offset Removal	368
Duplicate	369
Gain	369
Invert.	370
Normalize	370
Reverse.	371
Index	372

Part I: Introduction to Audio Plug-Ins

Chapter 1: Audio Plug-Ins Overview

Plug-ins are special-purpose software components that provide additional signal processing and other functionality to Pro Tools® | HD and Pro Tools software. These include plug-ins that come with your Pro Tools system, as well as many other plug-ins that can be purchased or rented from Avid® separately. This guide documents all 64-bit AAX audio plug-ins available from Avid for Pro Tools, VENUE®, and Media Composer®.

 *Additional plug-ins are available from third-party developers. For more information, visit www.avid.com/plugins.*

Plug-In Formats

AAX (Avid Audio Extension) plug-ins provide real-time plug-in processing using host-based (“Native”) or DSP-based (HDX systems only) processing. The AAX plug-in format also supports AudioSuite non-real-time, file-based rendered processing. AAX plug-in files use the “.aaxplugin” file suffix.

There are three plug-in formats used in Pro Tools:

- AudioSuite™: non-real-time, file-based processing
- AAX Native: real-time, host-based plug-ins
- AAX DSP: real-time, DSP-based plug-ins (HDX systems only)

Avid Audio Plug-Ins

Avid includes a comprehensive set of sound processing, effects, and utility plug-ins with all Pro Tools systems. Other Avid plug-ins are available for purchase or rental from the Avid store (visit shop.avid.com, or, in Pro Tools, choose Marketplace > Plug-Ins).

Avid Audio Plug-Ins Included with Pro Tools

Pro Tools includes a suite of digital signal processing effects, including EQ, dynamics, delay, and other essential audio processing tools. The following plug-ins are included with Pro Tools:

EQ

- Channel Strip (see “Dynamics”)
- EQ III
 - 1 Band
 - 7 Band

Dynamics

- BF76 Compressor
- Channel Strip
- Dynamics III
 - Compressor/Limiter
 - Expander/Gate
 - De-Esser
- Maxim™

Pitch and Time Shift

- Pitch II
- Time Shift
- Vari-Fi™

Reverb

- D-Verb

Delay

- Mod Delay III
- TimeAdjuster

Modulation

- Sci-Fi™

Harmonic

- Eleven® Lite
- Lo-Fi™
- Recti-Fi™
- SansAmp PSA-1

Dither

- Dither
- POW-r Dither

Sound Field

- AutoPan™
- Down Mixer

Instrument

- Click II
- ReWire

Other

- DC Offset Removal (AudioSuite only)
- Duplicate (AudioSuite only)
- Gain (AudioSuite only)
- Invert (AudioSuite only)
- Normalize (AudioSuite only)
- Reverse (AudioSuite only)
- Signal Generator
- Time Compression/Expansion
- InTune™
- MasterMeter™
- Trim

Additional Avid Audio Plug-Ins

The following plug-ins are available separately for purchase and rental:

- Aphex Aural Exciter® Type III
- Aphex Big Bottom Pro®
- BF-2A
- BF-3A
- Eleven® guitar amplifier modeling plug-in
- Fairchild 660 and 670
- Focusrite d2/d3
- Impact®
- JOEMEEK SC2 Compressor
- JOEMEEK VC5 Meequalizer
- Moogerfooger plug-ins
 - Moogerfooger Analog Delay
 - Moogerfooger Ring Modulator
 - Moogerfooger 12-Stage Phaser
 - Moogerfooger Lowpass Filter

- Pro Compressor
- Pro Expander
- Pro Limiter
- Pro Multiband Dynamics
- Pro Subharmonic
- Purple Audio MC77
- Reel Tape™ plug-ins:
 - Reel Tape Saturation
 - Reel Tape Delay
 - Reel Tape Flanger
- Reverb One™
- ReVibe® II
- Smack!™
- SoundReplacer™
- Space™
- Tel-Ray Variable Delay
- Voce Spin
- Voce Chorus/Vibrato
- X-Form

Using Plug-Ins in Pro Tools

See the *Pro Tools Reference Guide* for information on working with plug-ins, including:

- Inserting plug-ins on tracks
- Plug-In Window controls
- Adjusting plug-in controls
- Automating plug-ins
- Using side-chain inputs
- Using plug-in presets
- Clip indicators

Avid Application Manager

When you install Pro Tools or Media Composer, the Avid Application Manager is also installed. The Avid Application Manager is used to manage your software and entitlements related to your MyAvid account. The Avid Application Manager helps you maintain the most current Pro Tools software and audio plug-in updates that you are entitled to when new versions become available. For more information about the Avid Application Manager, see the *Avid Application Manager Guide* (available online through the Avid Knowledgebase).

Conventions Used in Pro Tools Documentation

Pro Tools documentation uses the following conventions to indicate menu choices, keyboard commands, and mouse commands:

Convention	Action
File > Save	Choose Save from the File menu
Control+N	Hold down the Control key and press the N key
Control-click	Hold down the Control key and click the mouse button
Right-click	Click with the right mouse button

The names of Commands, Options, and Settings that appear on-screen are in a different font.

The following symbols are used to highlight important information:



User Tips are helpful hints for getting the most from your system.



Important Notices include information that could affect your data or the performance of your system.



Shortcuts show you useful keyboard or mouse shortcuts.



Cross References point to related sections in this guide and other Avid documentation.

System Requirements and Compatibility for Plug-Ins

To use Pro Tools plug-ins, you need the following:

- An Avid-qualified system running Pro Tools or Pro Tools | HD Software
- An iLok USB key (iLok) for plug-ins that can be purchased or rented

Avid can only assure compatibility and provide support for hardware and software it has tested and approved.

For complete system requirements and a list of Avid-qualified computers, operating systems, hard drives, and third-party devices, visit:

www.avid.com/compatibility

Third-Party Plug-In Support

For information on third-party plug-ins for Pro Tools systems, refer to the documentation that came with your plug-in.

About www.avid.com

The Avid website (www.avid.com) is your best online source for information to help you get the most out of your Pro Tools system. The following are just a few of the services and features available.

Product Registration Register your purchase online.

Support and Downloads Contact Avid Customer Success (technical support); download software updates and the latest online manuals; browse the Compatibility documents for system requirements; search the online Knowledge Base or join the worldwide Pro Tools community on the User Conference.

Training and Education Study on your own using courses available online or find out how you can learn in a classroom setting at a certified Pro Tools training center.

Products and Developers Learn about Avid products; download demo software or learn about our Development Partners and their plug-ins, applications, and hardware.

News and Events Get the latest news from Avid or sign up for a Pro Tools demo.

Chapter 2: Installing and Authorizing Avid Plug-Ins

A core set of audio plug-ins is installed automatically with your version of Pro Tools. No additional steps are required to authorize these plug-ins for use on your Pro Tools system.

Installers for additional plug-ins purchased or rented from the Avid store (shop.avid.com) can be downloaded from your online Avid account. These plug-ins are authorized using an iLok USB key.

About iLok

The plug-ins documented in this guide are authorized using an iLok USB key from PACE Anti-Piracy.



iLok USB key (2nd generation)

An iLok can hold hundreds of authorizations for all of your iLok-enabled software. After a software license is placed on an iLok, you can use the iLok to authorize that software on any computer.

An iLok USB key is not supplied with plug-ins or software options. You can use the iLok included with certain Pro Tools systems, or purchase one separately.

 *For more information, visit the iLok website (www.iLok.com).*

Authorizing Avid Audio Plug-Ins

When you purchase a boxed version of an Avid Audio plug-in, you receive an activation code on an activation card. If you purchase or rent a plug-in through the Avid Marketplace, the license is deposited directly to your iLok account and you can skip the following procedure (see “Installing Plug-Ins from the Avid Marketplace” on page 8).



If you open a session that uses plug-ins that are not installed and authorized on your system, you are prompted to rent or purchase those missing plug-ins though the Avid Marketplace if available.

To authorize your plug-in, follow the steps below, or visit www.avid.com/activationcard and follow the online instructions.

To authorize Avid Audio plug-ins:

- 1 If you don't already have an iLok account, visit www.ilok.com to sign up for an account.
- 2 Visit www.avid.com/activation and log into your Avid account (if you don't already have an Avid account, click “Create Your Account”).
- 3 Enter your activation code and your iLok.com User ID.
- 4 Follow the on-screen instructions to deposit your license into your iLok.com account.

- 5 Once the activation process is complete, the download links for your Avid audio plug-in will be available in the My Products section of your Avid account.
- 6 Download and install the plug-in that you purchased.
- 7 Make sure your iLok is connected to an available USB port on your computer.
- 8 Launch Pro Tools and follow the on-screen instructions to transfer the plug-in license to your iLok and authorize the plug-in.

Installing Plug-Ins for Pro Tools and Media Composer

 For information on installing plug-ins for VENUE, refer to your VENUE documentation..

To install a plug-in:

- 1 Download the appropriate installer for your operating system (Mac or Windows) from www.avid.com. After downloading, make sure the installer is uncompressed (.dmg or .zip).
- 2 Locate and double-click the plug-in installer.
- 3 Follow the on-screen instructions to complete the installation.

Installing Plug-Ins from the Avid Marketplace

All plug-ins purchased from the Avid Marketplace through Pro Tools are installed silently and, following activation, are available for use without having to restart Pro Tools.

To install a plug-in from the Avid Marketplace:

- 1 Launch Pro Tools.
- 2 Either choose Marketplace > Plug-Ins or select Avid Marketplace from any plug-in insert in your Pro Tools session.
- 3 Find the plug-in you want in the Avid Marketplace and follow the on-screen instructions.



You can also access the Avid Marketplace online at shop.avid.com.

Removing Plug-Ins

If you need to remove a plug-in from your Pro Tools system, follow the instructions below for your computer platform.

Removing Plug-Ins on Mac

To remove a plug-in:

- 1 Locate and open the Plug-Ins folder on your Startup drive (Library/Application Support /Avid/Audio/Plug-Ins).
- 2 Do one of the following:
 - Drag the plug-in to the Plug-Ins (Unused) folder.
 - Drag the plug-in to the Trash and empty the Trash.

Removing Plug-Ins on Windows

To remove a plug-in:

- 1 Choose Start > Control Panel.
- 2 Click Programs and Features.
- 3 Select the plug-in from the list of installed applications.
- 4 Click Uninstall.
- 5 Follow the on-screen instructions to remove the plug-in.

Chapter 3: Adjusting Plug-In Controls

You can adjust plug-in controls by dragging on-screen controls, by editing control values, or by dragging in graphic displays.

Dragging Plug-In Controls

Rotary Controls

Some plug-ins have rotary controls that can be adjusted by dragging over them horizontally or vertically.

To adjust a rotary control:

- 1 Click on the control.
- 2 Do any of the following:
 - Drag up or to the right to increment the control.
 - Drag down or to the left to decrement the control.



Adjusting a rotary control by dragging (EQ III)

Slider Controls

Some plug-ins have slider controls that can be adjusted by dragging horizontally.

Some sliders are *bipolar*, meaning that their zero position is in the center of the slider's range. Dragging to the right of center yields a positive value, and dragging to the left of center yields a negative value.

To adjust a slider control:

- 1 Click on the control.
- 2 Do any of the following:
 - Drag to the right to increment the control.
 - Drag to the left to decrement the control.



Adjusting a slider control by dragging (ReVibe II)

Editing Control Values

Some controls have text boxes that display the current control value. You can edit the control value directly.

To edit control values:

- 1 Click in the text box corresponding to the control that you want to adjust.
- 2 Do any of the following:
 - Type a new value. For controls that support values in kilohertz, typing “k” after a numeric value will multiply the value by 1000.
 - To increment the value, scroll up with a mouse or scroll wheel, or press the Up Arrow key.
 - To decrement the value, scroll down with a mouse or scroll wheel, or press the Down Arrow key.
- 3 Do one of the following:
 - Press Enter on the numeric keyboard to input the value and remain in keyboard editing mode.
 - Press Return (Mac) or Enter (Windows) on the alpha keyboard to enter the value and leave keyboard editing mode.



Typing a control value (EQ III)

To move forward through control text boxes in a plug-in:

- Press the Tab key.

To move backward through control text boxes in a plug-in:

- Press Shift+ Tab.

Dragging in Graphic Displays

Some plug-ins have graphic displays with control points that you can drag to adjust the corresponding controls.

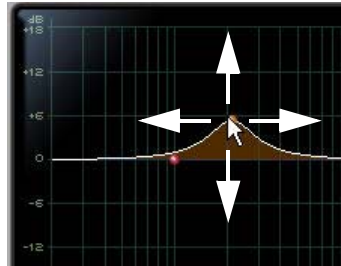

Dragging a control point (EQ III)



Dragging a control point (ReVibe II)

Adjusting Controls with Fine Resolution

Controls and control points can be adjusted with fine resolution by holding the Command key (Mac) or the Control key (Windows) while adjusting the control.

Resetting Controls to Default Values

You can reset any on-screen control to its default value by Option-clicking (Mac) or Alt-clicking (Windows) directly on the control or on its corresponding text box.

Part II: EQ Plug-Ins

Chapter 4: EQ III

The EQ III plug-in provides high-quality 1-Band and 7-Band EQ for adjusting the frequency spectrum of audio material.

EQ III is available in DSP, Native, and AudioSuite formats.

EQ III supports 44.1 kHz, 48 kHz, 88.2 kHz, 96 kHz, 176.4 kHz and 192 kHz sample rates.

EQ III operates as a mono, multi-mono, or stereo plug-in.

EQ III has a Frequency Graph display that shows the response curve for the current EQ settings on a two-dimensional graph of frequency and gain. The frequency graph display also lets you modify frequency, gain and Q settings for individual EQ bands by dragging their corresponding points in the graph.

EQ III Configurations

The EQ III plug-in appears as two separate choices in the plug-in insert selector and in the AudioSuite menu:

- EQ3 1-Band
- EQ3 7-Band

1-Band EQ

The 1-Band EQ has its own window, with six selectable filter types for a single band of EQ.



1-Band EQ

7-Band EQ

The 7-Band EQ has its own window, with up to seven separate bands, each with its own set of filter types.



7 Band EQ

Adjusting EQ III Controls

In addition to dragging controls and typing control values, there are other ways to adjust EQ III controls.

Inverting Filter Gain

(Peak EQ Bands Only)

Gain values can be inverted on any Peak EQ band by Shift-clicking its control dot in the Frequency Graph display, or its Gain knob in the plug-in window. This changes a gain boost to a cut (+9 to -9) or a gain cut to a boost (-9 to +9). Gain values cannot be inverted on Notch, High Pass, Low Pass, or shelving bands.

Dragging in the Frequency Graph Display

You can adjust the following by dragging the control points directly in the Frequency Graph display:

Frequency Dragging a control point to the right increases the Frequency setting. Dragging a control point to the left decreases the Frequency setting.

Gain Dragging a control point up increases the Gain setting. Dragging a control point down decreases the Gain setting.

Q Control-dragging (Mac) or Start-dragging (Windows) a control point up decreases the Q setting. Control-dragging (Mac) or Start-dragging (Windows) a control point down increases the Q setting.

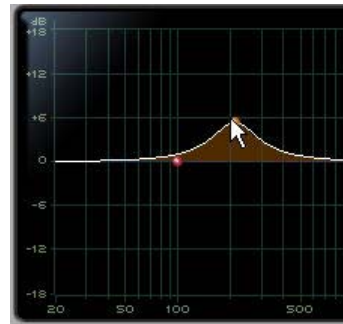

Dragging a control point in the Frequency Graph display

Using EQ III in Band-Pass Mode

You can temporarily set any EQ III control to Band-Pass monitoring mode. Band-Pass mode cuts monitoring frequencies above and below the Frequency setting, leaving a narrow band of mid-range frequencies. It is especially useful for adjusting limited bandwidth in order to solo and fine-tune each individual filter before reverting the control to notch filter or peaking filter type operations.

 *Band-Pass mode does not affect EQ III Gain controls.*

To switch an EQ III control to Band-Pass mode:

- Hold Control+Shift (Mac) or Start+Shift (Windows), and drag any rotary control or control point horizontally or vertically.

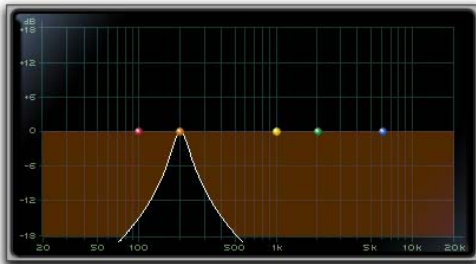

EQ III interactive graph displaying Band-Pass mode

When monitoring in Band-Pass mode, the Frequency and Q controls function differently.

Frequency Sets the frequency above and below which other frequencies are cut off, leaving a narrow band of mid-range frequencies.

Q Sets the width of the narrow band of mid-range frequencies centered around the Frequency setting.

To switch an EQ III control out of Band-Pass mode:

- Release Control+Shift (Mac) or Start+Shift (Windows).

Controlling EQ III from a Control Surface

EQ III can be controlled from any supported control surface, including EUCON-compatible control surfaces, D-Control, D-Command, C|24, and 003. Refer to the guide that came with the control surface for details.

EQ III I/O Controls

Certain Input and Output controls are found on all EQ III configurations, except where noted otherwise.

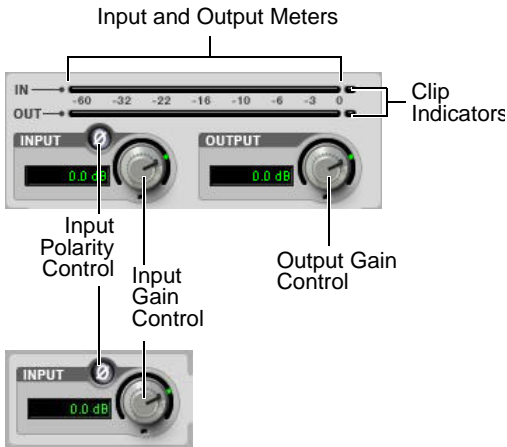

I/O controls and meters for 7-Band EQ (top) and 1-Band EQ (bottom)

Input Gain Control

The Input Gain control sets the input gain of the plug-in before EQ processing, letting you make up gain or prevent clipping at the plug-in input stage.

Output Gain Control (7-Band EQ Only)

The Output Gain control sets the output gain after EQ processing, letting you make up gain or prevent clipping on the channel where the plug-in is being used.

Input Polarity Control

The Input Polarity button inverts the polarity of the input signal to help compensate for phase anomalies occurring in multi-microphone environments, or because of mis-wired balanced connections.

Input and Output Meters (7-Band EQ Only)

The plasma-style Input and Output meters show peak signal levels before and after EQ processing, and indicate them as follows:

Green Indicates nominal levels

Yellow Indicates pre-clipping levels, starting at -6 dB below full scale

Red Indicates full scale levels (clipping)

When using the stereo version of EQ III, the Input and Output meters display the sum of the left and right channels.

The Clip indicators at the far right of each meter indicate clipping at the input or output stage of the plug-in. Clip indicators can be cleared by clicking the indicator.

EQ III EQ Band Controls

Individual EQ bands on each EQ III configuration have a combination of controls.

EQ Type Selector

On the 1-Band EQ, the EQ Type selector lets you choose any one of six available filter types: High Pass, Notch, High Shelf, Low Shelf, Peak, and Low Pass.

On the 7-Band EQ, the HPF, LPF, LF, and HF sections have EQ Type selectors to toggle between the two available filter types in each section.



EQ Type Selectors (7-Band EQ)

Band Enable Button (7-Band EQ Only)

The Band Enable button on each EQ band toggles the corresponding band in and out of circuit. When a Band Enable button is highlighted, the band is in circuit. When a Band Enable button is dark gray, the band is bypassed and available for activation.

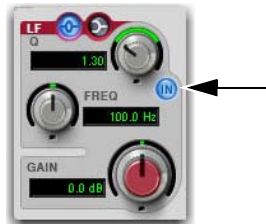

Band Enable button

Band Gain Control

Each Peak and Shelf EQ band has a Gain control for boosting or cutting the corresponding frequencies. Gain controls are not used on High Pass, Low Pass, or Notch filters.

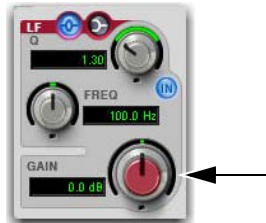

Band Gain control

Frequency Control

Each EQ band has a Frequency control that sets the center frequency (Peak, Shelf and Notch EQs) or the cutoff frequency (High Pass and Low Pass filters) for that band.

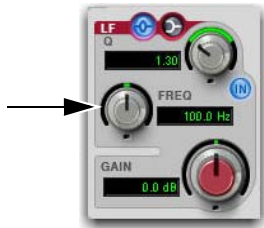

Frequency control

Q Control

Peak and Notch On Peak and Notch bands, the Q control changes the width of the EQ band. Higher Q values represent narrower bandwidths. Lower Q values represent wider bandwidths.

Shelf On Shelf bands, the Q control changes the Q of the shelving filter. Higher Q values represent steeper shelving curves. Lower Q values represent broader shelving curves.

Band Pass On High Pass and Low Pass bands, the Q control lets you select from any of the following Slope values: 6 dB, 12 dB, 18 dB, or 24 dB per octave.

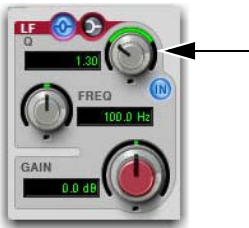

Q control

1-Band EQ III

The Frequency Graph display in the 1-Band EQ shows a control dot that indicates the center frequency (Peak, Shelf and Notch Filters) or the cutoff frequency (High Pass and Low Pass filters) for the currently selected filter type.

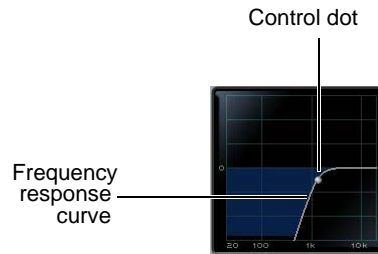

Frequency Graph display

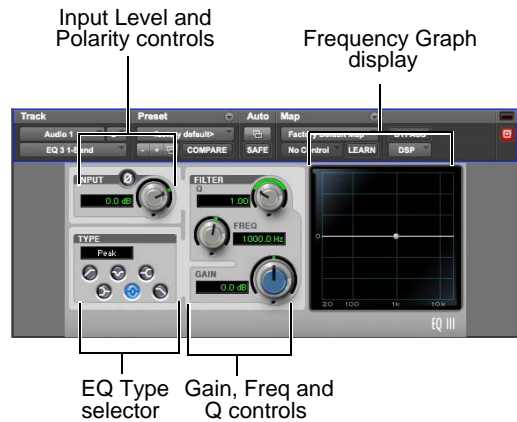

1-Band EQ

The 1-Band EQ may be set to any one of six EQ types: High Pass, Notch, High Shelf, Low Shelf, Peak, and Low Pass, by clicking the corresponding icon in the EQ Type selector.

Band Controls

The individual EQ types have some combination of the following controls, as noted below.

Control	Value
Frequency Range (All)	20 Hz to 20 kHz
Frequency Default (All)	1 kHz
Q Range (Low/High Shelf)	0.1 to 2.0
Q Range (Peak/Notch)	0.1 to 10.0
Q Default (All)	1.0
Gain Range (Low/High Shelf)	-12 dB to +12 dB
High Peak Gain Range	-18 dB to +18 dB

1-Band EQ III Types

High Pass Filter

The High Pass filter attenuates all frequencies below the Frequency setting at the selected rate (6 dB, 12 dB, 18 dB, or 24 dB per octave) while letting all frequencies above pass through. No gain control is available for this filter type.



1-Band EQ set to High Pass Filter

Notch Filter

The Notch Filter attenuates a narrow band of frequencies centered around the Frequency setting. No gain control is available for this EQ type. The width of the attenuated band is determined by the Q setting.



1-Band EQ set to Notch Filter

High Shelf EQ

The High Shelf EQ boosts or cuts frequencies at and above the Frequency setting. The amount of boost or cut is determined by the Gain setting. The Q setting determines the shape of the shelving curve.



1-Band EQ set to High Shelf EQ

Low Shelf EQ

The Low Shelf EQ boosts or cuts frequencies at and below the Frequency setting. The amount of boost or cut is determined by the Gain setting. The Q setting determines the shape of the shelving curve.



1-Band EQ set to Low Shelf EQ

Peak EQ

The Peak EQ boosts or cuts a band of frequencies centered around the Frequency setting. The width of the affected band is determined by the Q setting.



1-Band EQ set to Peak EQ

Low Pass Filter

The Low Pass filter attenuates all frequencies above the cutoff frequency setting at the selected rate (6 dB, 12 dB, 18 dB, or 24 dB per octave) while letting all frequencies below pass through. No gain control is available for this filter type.



1-Band EQ set to Low Pass Filter

7-Band EQ III

The 7-Band EQ has the following available bands: High Pass/Low Notch, Low Pass/High Notch, Low Shelf/Low Peak, Low Mid Peak, Mid Peak, High Mid Peak, and High Shelf/High Peak.

All seven bands are available for simultaneous use. In the factory default setting, the High Pass/Low Notch and Low Pass/High Notch bands are out of circuit, the Low Shelf and High Shelf bands are selected and in circuit, and the Low Mid Peak, Mid Peak, High Mid Peak bands are in circuit.

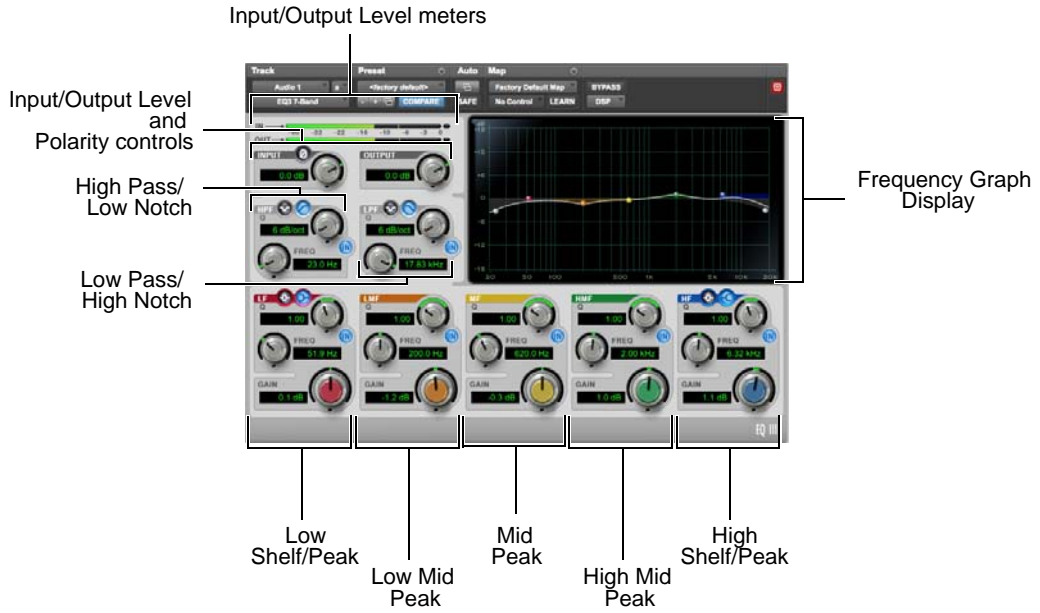

7-Band EQ

7-Band EQ III High Pass/Low Notch

The High Pass/Notch band is switchable between high pass filter and notch EQ functions. By default, this band is set to High Pass Filter.

High Pass Filter Attenuates all frequencies below the Frequency setting at the selected slope while letting all frequencies above pass through.

Low Notch EQ Attenuates a narrow band of frequencies centered around the Frequency setting. The width of the attenuated band is determined by the Q setting.

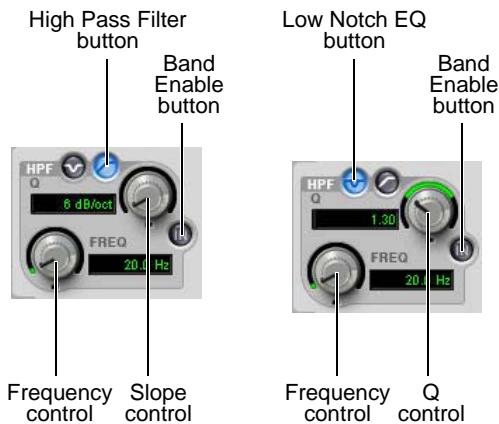

High Pass filter (left) and Low Notch EQ (right)

The High Pass and Low Notch EQ controls and their corresponding graph elements are displayed on-screen in gray. The following control values are available:

Control	Value
Frequency Range	20 Hz to 8 kHz
Frequency Default	20 Hz
HPF Slope Values	6, 12, 18, or 24 dB/oct
Low Notch Q Range	0.1 to 10.0
Low Notch Q Default	1.0

7-Band EQ III Low Pass/High Notch

The Low Pass/Notch band is switchable between low pass filter and notch EQ functions. By default, this band is set to Low Pass Filter.

Low Pass Filter Attenuates all frequencies above the Frequency setting at the selected slope while letting all frequencies below pass through.

High Notch EQ Attenuates a narrow band of frequencies centered around the Frequency setting. The width of the attenuated band is determined by the Q setting.

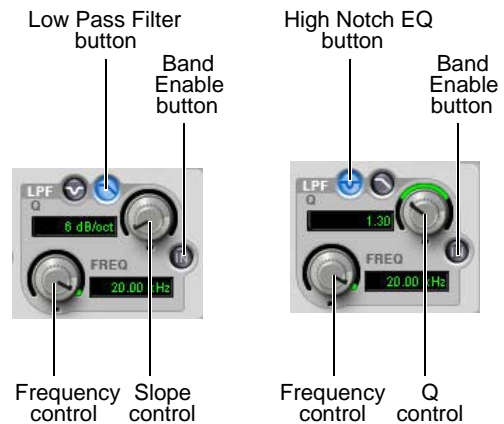

Low Pass filter (left) and High Notch EQ (right)

The Low Pass and High Notch EQ controls and their corresponding graph elements are displayed on-screen in gray. The following control values are available:

Control	Value
Frequency Range	120 Hz to 20 kHz
Frequency Default	20 kHz
HPF Slope Values	6, 12, 18, or 24 dB/oct
High Notch Q Range	0.1 to 10.0
High Notch Q Default	1.0

7-Band EQ III Low Shelf/Low Peak

The Low Shelf/Peak band is switchable between low shelf EQ and low peak EQ functions. By default, this band is set to Low Shelf.

Low Shelf EQ Boosts or cuts frequencies at and below the Frequency setting. The amount of boost or cut is determined by the Gain setting. The Q setting determines the shape of the shelving curve.

Low Peak EQ Boosts or cuts a band of frequencies centered around the Frequency setting. The width of the affected band is determined by the Q setting.

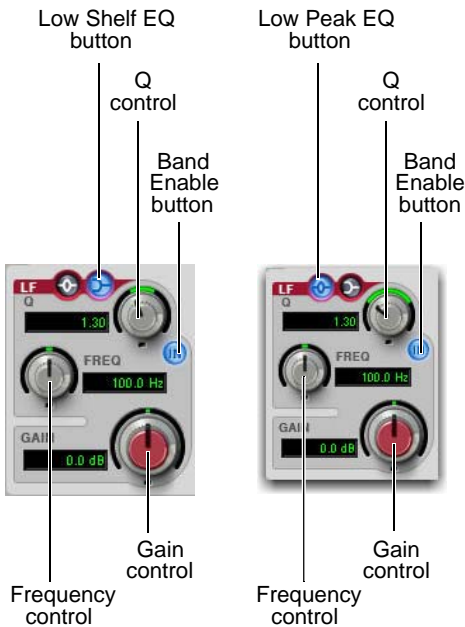

Low Shelf EQ (left) and Low Peak EQ (right)

The Low Shelf and Low Peak Gain controls and their corresponding graph elements are displayed on-screen in red. The following control values are available:

Control	Value
Frequency Range	20 Hz to 500 Hz
Frequency Default	100 Hz
Low Shelf Q Range	0.1 to 2.0
Low Peak Q Range	0.1 to 10.0
Q Default	1.0
Low Shelf Gain Range	-12 dB to +12 dB
Low Peak Gain Range	-18 dB to +18 dB

7-Band EQ III Low Mid Peak

The Low Mid Peak band boosts or cuts frequencies centered around the Frequency setting. The width of the band is determined by the Q setting.

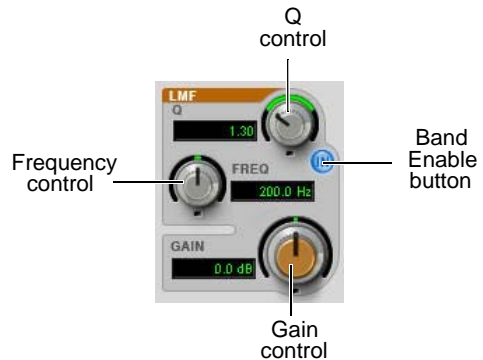

Low Mid Peak EQ

The Low Mid Gain control and its corresponding graph elements are displayed on-screen in brown.

The following control values are available:

Control	Value
Frequency Range	40 Hz to 1 kHz
Frequency Default	200 Hz
Low Mid Peak Q Range	0.1 to 10.0
Low Mid Peak Q Default	1.0
Low Mid Peak Gain Range	-18 dB to +18 dB

7-Band EQ III Mid Peak

The Mid Peak band boosts or cuts frequencies centered around the Frequency setting. The width of the band is determined by the Q setting.

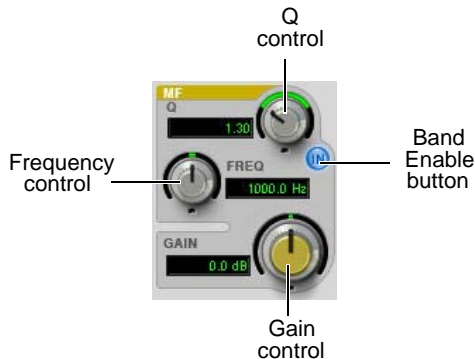

Mid Peak EQ

The Mid Gain control and its corresponding graph elements are displayed on-screen in yellow. The following control values are available:

Control	Value
Frequency Range	125 Hz to 8 kHz
Frequency Default	1 kHz
Mid Peak Q Range	0.1 to 10.0
Mid Peak Q Default	1.0
Mid Peak Gain Range	-18 dB to +18 dB

7-Band EQ III High Mid Peak

The High Mid Peak band boosts or cuts frequencies centered around the Frequency setting. The width of the band is determined by the Q setting.

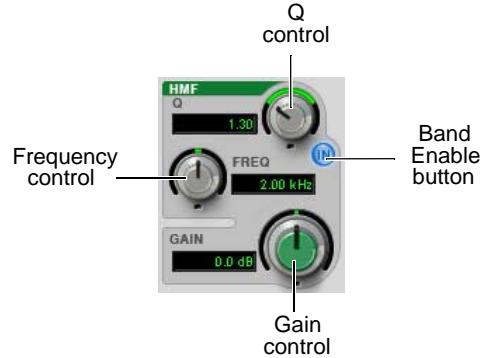

High Mid Peak EQ

The High Mid Gain control and its corresponding graph elements are displayed on-screen in green. The following control values are available:

Control	Value
Frequency Range	200 Hz to 18 kHz
Frequency Default	2 kHz
Mid Peak Q Range	0.1 to 10.0
Mid Peak Q Default	1.0
Mid Peak Gain Range	-18 dB to +18 dB

7-Band EQ III High Shelf/High Peak

The High Shelf/Peak band is switchable between high shelf EQ and high peak EQ functions. By default, this band is set to High Shelf.

High Shelf EQ Boosts or cuts frequencies at and above the Frequency setting. The amount of boost or cut is determined by the Gain setting. The Q setting determines the shape of the shelving curve.

High Peak EQ Boosts or cuts a band of frequencies centered around the Frequency setting. The width of the affected band is determined by the Q setting.

The High Shelf and High Peak Gain controls and their corresponding graph elements are displayed on-screen in blue. The following control values are available:

Control	Value
Frequency Range	1.8 kHz to 20 kHz
Frequency Default	6 kHz
High Shelf Q Range	0.1 to 2.0
High Peak Q Range	0.1 to 10.0
Q Default	1.0
High Shelf Gain Range	-12 dB to +12 dB
High Peak Gain Range	-18 dB to +18 dB

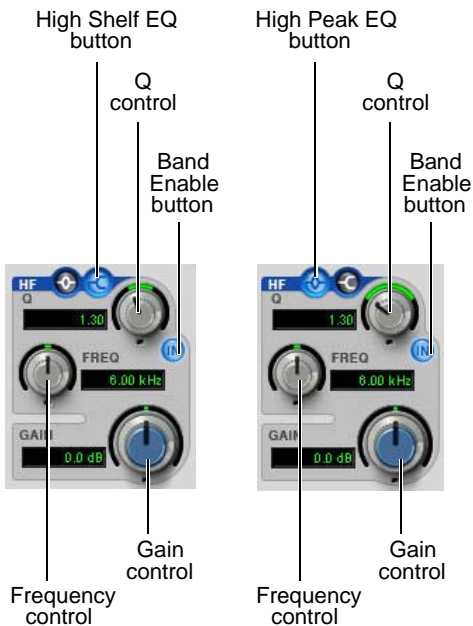

High Shelf EQ (left) and High Peak EQ (right)

Frequency Graph Display

(7-Band EQ Only)

The Frequency Graph display in the 7-Band EQ shows a color-coded control dot that corresponds to the color of the Gain control for each band. The filter shape of each band is similarly color-coded. The white frequency response curve shows the contribution of each of the enabled filters to the overall EQ curve.

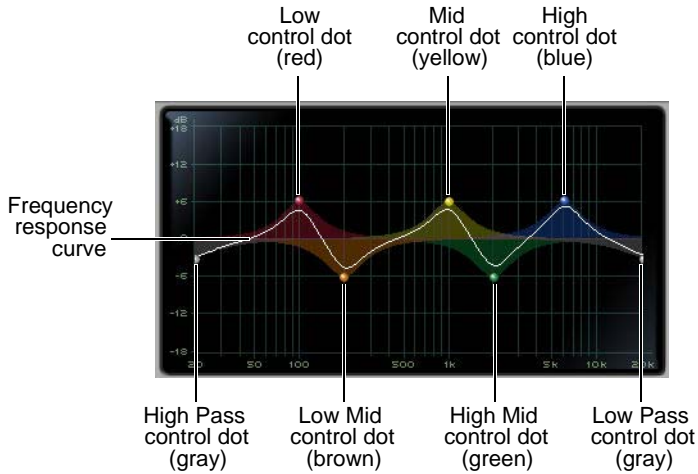

Frequency Graph display for the 7-Band EQ

Chapter 5: Focusrite D2

Focusrite D2 is a high-quality digital equalizer plug-in for Pro Tools. Developed in cooperation with Focusrite, the D2 is based on the highly-acclaimed Red Range 2™ dual EQ, designed by Rupert Neve. It provides up to six simultaneous bands of EQ, including: high-pass, low-shelf, low-mid peak, high-mid peak, high-shelf, and low-pass filters. D2 includes a highly accurate Cartesian graph that displays EQ curves in real-time as EQ controls are adjusted.

D2 is available in DSP, Native, and AudioSuite formats.

D2 supports 44.1 kHz, 48 kHz, 88.2 kHz, 96 kHz, 176.4 kHz and 192 kHz sample rates.

D2 operates as a mono, multi-mono, or stereo plug-in.



Focusrite D2

D2 Configurations

There are three configurations of the Focusrite D2 plug-in.

1–2 Band EQ

D2 1-2 Band can use up to two filters simultaneously, depending on which you enable. The high-pass, low-shelf, and low-pass filters each utilize the entire module and cannot be used in combination with another filter. The low-mid peak, high-mid peak, or high-shelf filters can be used in combination with each other (up to two bands total).

4-Band EQ

D2 4-Band can use up to four filters simultaneously. Any combination of filters can be engaged, up to a total of four bands.

6-Band EQ

D2 6-Band can use up to six filters simultaneously. Any combination of filters can be engaged, up to a total of six bands. By default, the low-pass and high-pass filters are in Bypass mode when the 6-Band EQ is first opened.

D2 Controls

Input Level

Input Level allows you to attenuate signal input level to the D2. The range of this control is from -18 dB to $+12$ dB.

When you use D2 in stereo, each channel has its own separate Input Level knob. To adjust input levels for both channels simultaneously, select the Link button, then drag either knob.

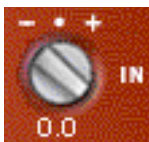

input Level

Output Level

Output Level allows you to adjust the overall output gain. The range of this control is from -18 dB to $+12$ dB.



Output Level

When you use the D2 plug-in in stereo, each channel has its own separate output level knob. To adjust output levels for both channels simultaneously, select the Link button.

Meters

The D2 high-resolution plasma-style meters indicate signal levels and detect clipping at the input, algorithm, or output stage. When D2 is used in stereo, two meters appear, one for each channel.

A Clip Indicator is located above each meter. It indicates clipping by increasing its brightness as successive samples are clipped. Click the Clip Indicator to clear it. Option-clicking (Mac) or Alt-clicking (Windows) clears both channels when D2 is used in stereo.

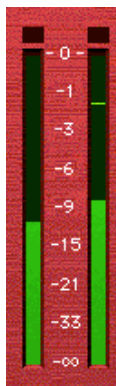

Meters (Stereo mode)

The following metering indications are used:

- Green = nominal levels
- Yellow = pre-clipping at -6 dB below full scale signal
- Red = full scale signal (clipping)

Frequency Display

The frequency display is a visual representation of the current EQ settings. As you adjust the controls of any currently active filter, the display plots the changes to the EQ curve in real-time. If you are using D2 in stereo, the frequency display shows the EQ curve for the right channel in red and the left channel in blue.

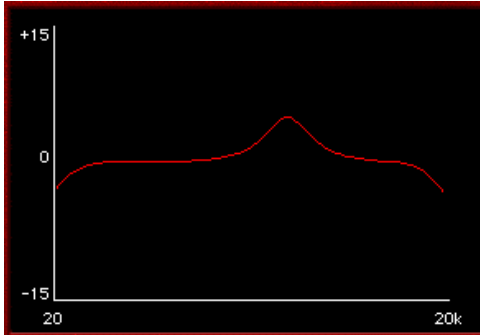

Cartesian Graph



To reset all D2 controls to their default settings, Option-click (Mac) or Alt-click (Windows) the frequency display. To reset controls for both channels when in Stereo mode, Option-Shift-click (Mac) or Alt-Shift-click (Windows) the frequency display.

EQ Filter Controls

Each of the six different EQ filters has its own controls and its own icon. The icons act as three-state switches for enabling, disabling, or bypassing the specific filter. The current state of a filter is indicated by its color:

- White = enabled. In this state the filter is active, audible, and using available DSP resources.
- Black = disabled. In this state the filter is not using any DSP resources and has no effect on audio.
- Gray = bypassed. In this state the filter is not active, but is still using available DSP resources. The effect of the filter is not audible.

High-Pass Filter

The 18 dB/octave High-Pass Filter provides a rotary control for adjusting the corner (cutoff) frequency, variable from 20 Hz to 6.4 kHz.



High-Pass Filter

Low-Shelf Filter

The Low-Shelf Filter provides two rotary controls: The upper rotary control adjusts the corner frequency, variable from 33 Hz to 460 Hz. The lower rotary control adjusts the filter's amplitude gain or attenuation. Amplitude range is ± 15 dB from unity.



Low-Shelf Filter

Low-Mid Peak Filter

The Low-Mid Peak Filter provides three rotary controls. The upper rotary control adjusts the center frequency, variable from 33 Hz to 6.4 kHz. The lower left rotary control adjusts the filter's amplitude gain or attenuation. Amplitude range is ± 15 dB from unity (utilizing a reciprocal curve for both gain and attenuation). The lower right rotary control adjusts filter "Q" which is variable from 0.7 to 4.0.



Low-Mid Peak Filter

High-Mid Peak Filter

The High-Mid Peak Filter provides three rotary controls. The upper rotary control adjusts the center frequency, variable from 120 Hz to 18 kHz. The lower left rotary control adjusts the filter's amplitude gain or attenuation. Amplitude range is ± 15 dB from unity (utilizing a reciprocal curve for both gain and attenuation). The lower right rotary control adjusts filter "Q" which is variable from 0.7 to 4.0.



High-Mid Peak Filter

High-Shelf Filter

The High-Shelf Filter provides two rotary controls: The upper rotary control adjusts the corner frequency, variable from 3.3 kHz to 18 kHz. The lower rotary control adjusts the filter's amplitude gain or attenuation. Amplitude range is ± 15 dB from unity.

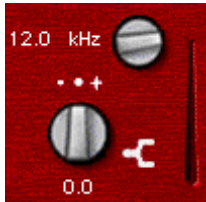

High-Shelf Filter

Low-Pass Filter

The 18 dB/octave Low-Pass Filter provides a rotary control for adjusting the filter's cutoff frequency, variable from 100 Hz to 18 kHz.



Low-Pass Filter

Enabling, Disabling and Bypassing EQ Filters

You can enable, disable, or bypass specific EQ filters by clicking them.

To disable a filter:

- Control-click (Mac) or Start-click (Windows) the EQ Filter icon. When disabled, the icon is black.

To re-enable a filter:

- Click the EQ filter icon. When enabled, the icon is white.

To bypass a filter:

- Click the EQ filter icon a second time. When bypassed, the icon is gray.

⚠ *If you are using all available bands of the 1–2 Band or 4–Band EQ and want to change filter types, you must disable one filter before you can enable a different one.*

Using D2 in Stereo

Because Focusrite D2 has a single set of Filter control knobs, when it is used in stereo, you must select which channel, left or right, you want to edit.

Left Channel and Right Channel Buttons

The Left Channel and Right Channel buttons are used to select which controls are active.



Left Channel, Right Channel, and Link buttons

Link Button

The Link button lets you adjust controls for both channels simultaneously. By default, Link mode is enabled so that you can maintain parity between channels.

You can also use Link mode to help you maintain a relative offset between control settings on the two channels.

To maintain an offset between channels:

- 1 Deselect the Link button.
- 2 Select a channel button, left or right, and adjust the controls for that channel.
- 3 Select Link mode and adjust the same controls for the opposite channel. D2 will maintain the relative offset between the two channels.



To copy the control settings of the active channel to the opposite channel, Option-click (Mac) or Alt-click (Windows) while linking channels.

Chapter 6: JOEMEEK VC5 Meequalizer

The JOEMEEK VC5 Meequalizer is an EQ plug-in that is available in DSP, Native, and AudioSuite formats.

VC5 supports 44.1 kHz, 48 kHz, 88.2 kHz, 96 kHz, 176.4 kHz and 192 kHz sample rates.

VC5 operates as a mono, multi-mono, or stereo plug-in.



JOEMEEK Meequalizer VC5 EQ

The VC5 offers simple controls with incredibly warm, musical results. Among countless other achievements, Joe Meek built custom gear to get the sounds in his head onto tape. One device was a treble and bass circuit with a sweepable mid control, built into a tiny tobacco tin. The Meequalizer VC5 virtually recreates the exact circuitry used by Joe Meek in this device.

JOEMEEK Meequalizer Controls

Operation of the Meequalizer is simple and to the point.

Bass The Bass control adjusts low frequencies ± 11 .

Mid and Mid Freq The Mid and Mid Freq controls allow you to adjust mid frequencies, from 500Hz to 3.5KHz, ± 11 .

Treble The Treble control adjusts high frequencies ± 11 .

Gain The Gain control allows you to adjust the output level ± 11 .

Chapter 7: Pultec Plug-Ins

The Pultec plug-ins are a set of EQ plug-ins that are available in DSP, Native, and AudioSuite formats. The following plug-ins are included:

- Pultec EQP-1A
- Pultec EQH-2
- Pultec MEQ-5

The Pultec plug-ins support 44.1 kHz, 48 kHz, 88.2 kHz, 96 kHz, 176.4 kHz and 192 kHz sample rates.

The Pultec plug-ins operate as mono, multi-mono, or stereo plug-ins.

Pultec EQP-1A

The Pultec EQP-1A provides smooth, sweet EQ and an extremely high quality tube audio signal path. Use it on individual tracks, critical vocals, or even across a stereo mix for mastering applications.



Pultec EQP-1A

Built in the early 1960s, the Pultec EQP-1A offers gentle shelving program equalization on bass and highs, and offers a variable bandwidth peak boost control. A custom (and secret) filter network provides all its equalization functionality. Quality transformers interface it to real-world studio equipment. A clean and well-designed tube amplifier provides a fixed amount of make-up gain.

Pultec EQP-1A Controls

Low Frequency Section Adjust low frequencies using the Boost and Atten knobs and the Low Frequency switch, located at the left side of the unit. All low-frequency equalization is a gentle shelving type, 6 dB per octave.

High Frequency Boost Section Boost mid and high frequencies using the Bandwidth and Boost knobs and the High Frequency switch.

High Frequency Attenuate Section Cut high frequencies using the Atten knob and the Atten Sel switch located at the right side of the plug-in.

Use caution, because the Sharp bandwidth setting results in up to 10 dB higher output than Broad bandwidth at maximum Boost, just like on the original. But don't feel like you're getting cheated. Consider anything that encourages very careful and infrequent use of peaky boosts to be a Very Good Thing.

Pultec EQH-2

The Pultec EQH-2 is a program equalizer similar to the Pultec EQP-1A. It is designed to provide smooth equalization across final mixes or individual tracks.



Pultec EQH-2

The Pultec EQH-2 offers three equalization sections: low frequency boost and attenuation, mid-range boost only, and 10k attenuation. Like its EQP-1A sibling, it features high-quality transformers and a tube gain stage. But unlike the EQP-1A, the tube stage in the EQH-2 is a push-pull design. As a result, the EQH-2 offers a beefier tone.

Pultec EQH-2 Controls

Low Frequency Section Adjust low frequencies using the top row of Boost and Atten knobs and the CPS (cycles per second) switch. All low-frequency equalization is a gentle shelving type, 6 dB per octave.

High Frequency Boost Section Boost mid and high frequencies using the KCS (kilocycles per second) and Boost knobs on the second row.

High Frequency Attenuate Section Cut high frequencies using the 10k Atten knob located at the right side of the plug-in.

Pultec MEQ-5

The Pultec MEQ-5 is the most unique equalizer in the Pultec family. It is particularly useful on individual tracks during mixdown.



Pultec MEQ-5

Pultec MEQ-5 Controls

The Pultec MEQ-5 offers three equalization sections: low frequency boost, mid frequency boost, and wide-range attenuation. Like all Pultecs, it features quality transformers and a tube gain stage.

Low Frequency Peak Boost low frequencies (200, 300, 500, 700, 1000 Hz) using the upper left controls.

Mid Frequency Peak Boost mid-frequencies (1.5k, 2k, 3k, 4k, 5k) using the controls at the upper right.

Wide-Range Dip Cut frequencies using Dip controls on the bottom row.

Pultec Tips and Tricks

“Q” and A

You may wonder why the Pultec EQP-1A has separate knobs for boost and cut. The short answer is that they connect to different circuitry in the unit.

You can use the “extra” knob to your advantage. Because the filters are not phase perfect, a Boost setting of 3 and an Atten setting of 3 can make a huge difference, even though a frequency plot wouldn’t show much difference in tone. You’re hearing the phase shift, not the tone shift.

Our ears are very sensitive to phase, and using the two knobs together, you can adjust phase at the low end while also making tonal adjustments.

On the high end, you can set Boost to 10k and Atten to 10k, then adjust Boost and Atten simultaneously. However, because Boost is a peak equalizer and Atten is a shelving equalizer, the results are much different, and you don’t get independent control of phase.

“Q” and Boost

In the high frequency boost section, the Bandwidth and Boost controls affect one another. This is different from modern equalizers, where adjusting Q typically doesn’t affect the amount of equalization applied.

Guitars

Have multiple guitars that sound like mush in the mix? The Pultec MEQ-5 is a classic tool for achieving amazing guitar blends. Try boosting one guitar and cutting another to achieve an octave of separation. For example, cut one guitar using 1.5 (1500 Hz) Dip, then boost the other using 3 (3000 Hz) Peak. View the matched pairs of presets (such as Guitar 1A and 1B or 2A and 2B) for further examples of this technique.

Part III: Dynamics Plug-Ins

Chapter 8: BF-2A

BF-2A is a vintage-style compressor plug-in that is available in DSP, Native, and AudioSuite formats.

BF-2A supports 44.1 kHz, 48 kHz, 88.2 kHz, 96 kHz, 176.4 kHz and 192 kHz sample rates.

BF-2A operates as a mono, multi-mono, or stereo plug-in.



BF-2A

Designed and manufactured in the early 1960s, the LA-2A achieved wide acclaim for its smooth compression action and extremely high quality audio signal path. The BF-2A has been meticulously crafted to capture every nuance of the legendary LA-2A tube studio compressor, providing the most authentic vintage compression sound available.

Originally designed as a limiter for broadcast audio, a Comp/Limit switch was added to LA-2A compressors after serial number 572. The subsequent addition of a Comp (Compress) setting made the LA-2A even more popular for use in audio production. However, the switch was inconveniently located on the back of the unit next to the terminal strips and tube sockets in the original version. In the BF-2A plug-in, the switch has been placed on the front panel, where you can make better use of it.

The heart of the LA-2A is its patented T4B Electro-Optical Attenuator, which provides the compression action. The T4B consists of a photoconductive cell, which changes resistance when light strikes it. It is attached to an electroluminescent panel, which produces light in response to voltage. Audio (voltage) is applied to the light source, and what happens as the audio converts to light and back to voltage gives the LA-2A its unique compression action (BF-2A preserves all the subtle characteristics of this unique electronic circuit). After compression, gain brings the signal back to its original level. The LA-2A's gain comes from a tube amplifier, which imparts further character to the tone. In fact, it's common to see engineers using the LA-2A simply as a line amp, without any compression applied to the signal.

One beautiful side effect of the LA-2A's elegant design is that it's easy to hear the compression action. When the BF-2A's two knobs are set properly, you know you got it right.

BF-2A Controls

The Peak Reduction and Gain controls combine with the Comp/Limit switch to determine the amount and sound of the compression. The following controls and meters are provided:

Gain Gain provides makeup gain to bring the signal back after passing through peak reduction.

Peak Reduction Peak Reduction controls the amount of signal entering the side-chain, which in turn affects the amount of compression and the threshold. The more Peak Reduction you dial in, the more “squashed” the sound. Too little peak reduction and you will not hear any compression action; too much and the sound becomes muffled and dead sounding.

Comp/Lim The Comp/Limit switch affects the compression ratio. The common setting for audio production is Comp, which provides a maximum compression ratio of approximately 3:1. In Limit mode, the unit behaves more like a broadcast limiter, with a higher threshold and compression ratio of approximately 12:1.

Meter Both Gain Reduction and Output metering are provided. The Meter knob operates as follows:

- When set to Gain Reduction, the meter needle moves backward from 0 to show the amount of compression being applied to the signal in dB.
- When set to Output, the needle indicates the output level of the signal. The meter is calibrated with 0 VU indicating -18 dBFS.

Using the BF-2A Side-Chain Filter

The BF-2A provides an extra, a side-chain filter, that does not have a control on the plug-in interface, but that can be accessed on-screen through Pro Tools automation controls. In addition, the side-chain filter can be adjusted directly from any supported control surface.

This side-chain filter reproduces the effect of an adjustable resistor on the back panel of the LA-2A. This control cuts the low frequencies from the side-chain, or control signal, that determines the amount of gain reduction applied by the compressor.

By increasing the value of the side-chain filter, you filter out frequencies below 250 Hz from the control signal, and decrease their effect on gain reduction.

- ◆ A setting of zero means that the filter is not applied to the side chain signal.
- ◆ A setting of 100 means that all frequencies below 250 Hz are filtered out of the side chain signal.

To access the side-chain filter on-screen:

- 1 Click the Plug-In Automation button in the Plug-In window to open the Automation Enable window.
- 2 In the list of controls at the left, click to select Side-Chain Filter and click Add (or just double-click a control in the list).
- 3 Click OK to close the plug-in automation window.

- 4 In the Edit window, do one of the following:
 - Click the Track View selector and select Side-Chain Filter from the BF-2A sub-menu.
 - Reveal an Automation lane for the track, click the Automation Type selector and select Side-Chain Filter from the BF-2A sub-menu.
- 5 Edit the breakpoint automation for the BF-2A side-chain filter. Control range is from 0 (the default setting where no filtering is applied to the side-chain) to 100% (maximum side-chain filtering).

To access the side-chain filter from a control surface:

- 1 Focus the BF-2A plug-in on your control surface.
- 2 Adjust the encoder or fader current targeting the Side-Chain Filter control.

 *For more information on plug-in automation, see the Pro Tools Reference Guide*

BF-2A Tips and Tricks

AudioSuite Processing

When using the AudioSuite version of the BF-2A, be sure to select an auxiliary side-chain input (normally the track you're processing). The default is "None" and if you leave it set like this, there is nothing feeding the detector and you will not hear any compression action.

Line Amp

Turn the Peak Reduction knob full counterclockwise (off) and use the Gain control to increase the signal level. Although the BF-2A does not compress the sound with these settings, it still adds its unique character to the tone.

Feed the BF-2A into the BF76

Or vice versa. Glynn Johns (who has worked with the Stones, the Who, and others) popularized the early '70s British trick of combining a slower compressor with a faster one. The effect can produce very interesting sounds! Try applying Peak Reduction using the BF-2A, then squash the missed attacks using the faster BF76.

Chapter 9: BF-3A

BF-3A is a vintage-style compressor plug-in that is available in DSP, Native, and AudioSuite formats.

BF-3A supports 44.1 kHz, 48 kHz, 88.2 kHz, 96 kHz, 176.4 kHz, and 192 kHz sample rates.

BF-3A operates as a mono, multi-mono, or stereo plug-in.



BF-3A

BF-3A is based on the classic LA-3A that adds a smoothness and sonic texture that makes sounds jump right out of the mix. Designed and manufactured in the late 1960s, the original LA-3A shares many components in common with the LA-2A compressor. Just like the LA-2A, the heart of the LA-3A is the T4B Electro-Optical Attenuator. This is a device that converts audio to light and back and is largely responsible for the compression character of the unit.

While the LA-2A's gain comes from a tube amplifier, the LA-3A's gain comes from a solid-state (transistor) amplifier. This gives the LA-3A a solid midrange and more aggressive tone. Other subtle modifications change the behavior of the T4B, causing it to respond differently—particularly in response to percussive material.

The LA-3A is famous for its unique sonic imprint on guitar, piano, vocals and drums. Because it's so easy to control, you'll be getting classic tones in no time with the BF-3A.

BF-3A Controls

The Peak Reduction and Output Gain controls combine with the Comp/Limit switch to determine the amount and sound of the compression. The following controls and meters are provided:

Peak Reduction Peak Reduction controls the amount of signal entering the side-chain. The more Peak Reduction you dial in, the more “squashed” and compressed the sound will be. Too little peak reduction and you won't hear any compression action; too much and the sound becomes muffled and dead sounding.

Output Gain Output Gain provides makeup gain to make the signal louder after passing through the peak reduction.

Comp/Lim The Comp/Limit switch affects the compression ratio. The common setting for audio production is Comp, which provides a maximum compression ratio of approximately 3:1. In Limit mode, the unit behaves more like a broadcast limiter, with a higher threshold and compression ratio of approximately 15:1.

Meter Both Gain Reduction and Output metering are provided. The Meter knob operates as follows:

- When set to Gain Reduction, the meter needle moves backward from 0 to show the amount of compression being applied to the signal in dB.
- When set to Output, the needle indicates the output level of the signal. The meter is calibrated with 0 VU indicating -18 dBFS.

BF-3A Tips and Tricks

AudioSuite Processing

When using the AudioSuite version of the BF-3A, be sure to select an auxiliary side-chain input (normally the track you are processing). The default is “None” and if you leave it set like this, there is nothing feeding the detector and you will not hear any compression action.

Line Amp

Turn the Peak Reduction knob full counterclockwise (off) and use the Gain control to increase the signal level. Although the BF-3A does not compress the sound with these settings, it still adds its unique character to the tone.

Chapter 10: BF76

BF76 is a vintage-style compressor plug-in that is available in DSP, Native, and AudioSuite formats.

BF76 supports 44.1 kHz, 48 kHz, 88.2 kHz, 96 kHz, 176.4 kHz and 192 kHz sample rates.

BF76 operates as a mono, multi-mono, or stereo plug-in.



BF76

Modeled after the solid-state 1176 studio compressor, BF76 preserves every sonic subtlety of this classic piece of studio gear.

The 1176 Compressor, originally introduced in the late 1970s, uses a FET (field-effect transistor). The 1176 also uses solid state amplification. The 1176 still provides an extremely high quality audio signal path, but because of these internal differences, offers a much different compression sound than other compressors.

Four selectable compression ratios are provided, along with controls allowing variable attack and release times.

BF76 Controls

BF76 provides the following controls:

Input The Input control sets the input signal level to the compressor, which, in the 1176 design, determines both the threshold and amount of peak reduction.

Output The Output control sets output level. Use it to bring the signal back to unity after applying gain reduction.

Attack and Release The Attack and Release controls set the attack and release times of the compressor. Full counterclockwise is slowest, and full clockwise is fastest. Attack times vary between 0.4 milliseconds to 5.7 milliseconds. Release times vary between 60 and 1,100 milliseconds.

Ratio The Ratio Push switches select the compression ratio from 4:1 to 20:1.

Meter The Meter Push switches affect the metering.

- GR shows the amount of gain reduction.
- -18 and -24 show the output level (calibrated so that 0VU indicates -18dB FS and -24dB FS respectively).
- The “Off” switch turns off the meter.

BF76 Tips and Tricks

AudioSuite Processing

When using the AudioSuite version of BF76, be sure to select a side-chain input (normally the track you are processing). The default is “None” and if you leave it set like this, there’s nothing feeding the detector and you won’t hear any compression action.

Unexpected Visit from A&R Weevil Yields Instant Hit Mix

A favorite feature on one megabuck mixing console is its stereo bus compressor. With the flick of a switch, a punchy 8:1 compressor grabs the current mix producing “instant radio hit.” It’s also a handy way to make quick headphone submixes when tracking overdubs.

Give the Kids What They Want

Shift-click one of the Ratio Push switches to enable the “All Buttons In” mode. The compression ratio is still only 20:1, but the knee changes drastically and the compressor starts (mis)behaving a little bit like an expander—watch the meter for details. Hey, try it—sometimes it even sounds good.

Selecting Proper Attack and Release Times

As on the original unit, setting either the attack or release time too fast generates signal distortion. Again, this may or may not be a effect. A good starting point for attack and release is “6” and “3” (the defaults), and you can adjust as follows:

When compressing, use the slowest attack you can that preserves a dynamic range. Faster attacks remove the “punch” from the performance; slower attacks inhibit the compression you need to smooth things out.

When limiting, use the fastest attack time you can before you start to hear signal distortion in the low end. With BF76, the attack time ranges from “incredibly fast” to “really damn fast” by modern standards. It can be hard to hear the difference.

Release times are more critical with BF76. To set release times, listen for loud attacks and what happens immediately after the peaks. Set the release time fast enough that you don’t hear unnatural dynamic changes, but slow enough that you don’t hear unnecessary pumping between two loud passages in rapid succession.

Chapter 11: Channel Strip

Avid Channel Strip is available in DSP, Native, and AudioSuite formats. Channel Strip provides EQ, Dynamics, Filter, and Gain effects. Channel Strip processing algorithms are based on the award-winning Euphonix System 5 console channel strip effects.

Channel Strip supports 44.1 kHz, 48 kHz, 88.2 kHz, 96 kHz, 176.4 kHz and 192 kHz sample rates.

Channel Strip supports mono, stereo, and greater-than-stereo multichannel formats up to 7.1.

⚠ *Greater-than-stereo formats are only available with Pro Tools HD.*



Channel Strip, Compressor/Limiter tab shown

In addition to standard knob and fader controls, Channel Strip also provides a graph to track the gain transfer curve for the Expander/Gate, Compressor/Limiter, and Side Chain effects, and a Frequency Graph display that shows the response curve for the current EQ setting on a two-dimensional graph of frequency and gain. The frequency graph display also lets you modify frequency, gain, and Q settings for individual EQ bands by dragging their corresponding points in the graph.

Channel Strip provides different sections for signal metering and gain adjustment, signal path ordering, dynamics processing, and equalization and filtering.

Channel Strip Sections and Panes

The Channel Strip plug-in window is organized in several sections: Input, FX Chain, Output, Dynamics, and EQ/Filters. The Dynamics and EQ/Filters sections can be independently shown or hidden. This lets you access controls or free up screen space, depending on your needs.

When showing the Dynamics or EQ/Filters sections, several tabbed panes of controls are available for each section. You can click a tab to show the controls for that tabbed pane. For Expand/Gate and Compressor/Limiter, and also for the For the EQ and Filter effects, clicking the corresponding control point on the graph display automatically shows the tab for Expander/Gate or the Compressor/Limiter, or the corresponding EQ band or Filter.

Showing or Hiding the Dynamics and EQ/Filters Sections

You can independently show or hide the Dynamics and EX/Filters sections of the Channel Strip plug-in to use less screen space. These sections are shown by default.

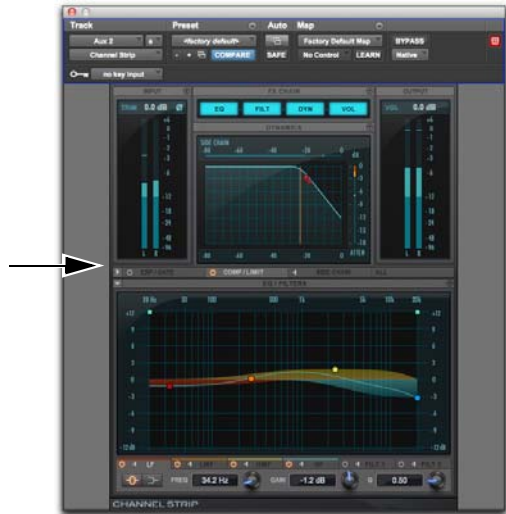

Channel Strip, Dynamics section hidden

To hide (or show) the Dynamics or EQ/Filters section of the plug-in window:

- Click the Show/Hide triangle to the left of the section you want to show or hide.

Disabling or Enabling Channel Strip Effects

You can independently disable effects in the Dynamics and EX/Filters sections of the Channel Strip plug-in. For example, you may want to apply Comp/Limit processing to the signal, but not Exp/Gate; or, you may want to only apply only a high pass filter.



Dynamics section, Exp/Gate disabled

To enable effects in the Dynamics or EQ/Filters section:

- Click the Enable/Disable button for the effect you want to enable so that it is highlighted.

To disable effects in the Dynamics or EQ/Filters section:

- Click the Enable/Disable button for the effect you want to disable so that it is *not* highlighted.

Listen Mode

The Side Chain tab in the Dynamics section, and the EQ and Filter tabs in the EQ/Filter section provide a Listen button.

- ◆ When enabled for the Side Chain, Listen mode lets you hear the input signal that feeds the dynamic section. This can be either the external key input or the internal side chain (including the applied filter).
- ◆ When enabled for any of the EQ bands, Listen solos the corresponding EQ band and (temporarily) inverts the EQ Type so that you can tune the Frequency and the Q for that EQ band.
- ◆ When enabled for either of the Filter effects, Listen solos the enabled Filter band and inverts the Filter. This allows you to hear only hear the portion of the audio signal that is being removed by the filter.

To enable (or disable) Listen on the Side Chain effect, EQ band, or a Filter effect:

- Click the Listen button for the Dynamics or EQ/Filter tab you want so that it is highlighted. Click it again so that it is not highlighted to disable it.



Channel Strip, Chain Listen mode enabled

 **Control-Shift-click (Mac) or Start-Shift-click (Windows) and hold an EQ or Filter control point in the Frequency Graph to temporarily switch to Listen mode for that EQ band or Filter effect.**

Channel Strip Input Section

The Input section provides input metering, and controls for trimming the input signal and inverting its phase. It can also be toggled to show post-processing gain reduction meters.



Input section (5.1 channel format shown)

Input Trim Control

The Input Trim control sets the input gain of the plug-in before EQ processing, letting you make up gain or prevent clipping at the plug-in input stage.

To Trim the input signal, do one of the following:

- Click in the Input Trim field and type a Trim value (–36.0 dB to +36.0 dB).
- Click Trim and drag up or down to adjust the Input Trim setting.

Phase Invert

The Phase Invert button at the top of the Input section inverts the phase (polarity) of the input signal, to help compensate for phase anomalies that can occur either in multi-microphone environments or because of mis-wired balanced connections.

To enable (or disable) phase inversion on input:

- Click the Phase Invert button so that it is highlighted. Click it again so that it is not highlighted to disable it.

Input Meters

The Input meters show peak signal levels before processing:

Dark Blue Indicates nominal levels from –INF to –12 dB.

Light Blue Indicates pre-clipping levels, from –12 dB to 0 dB.

White Indicates full scale levels from 0 dB to +6 dB.

Gain Reduction Meters

The Input meter can be switched to show Gain Reduction metering for the processed signal from 0 dB to –36 dB.

The Gain Reduction meters are usually displayed in yellow. When the Knee setting for either or both the Expander and the Compressor is greater than 0 dB, the Gain Reduction meter displays the amount of the Knee level in amber over the meter's usual yellow display.

To toggle between the Gain Reduction and Input meters:

- Click the Input/Gain Reduction toggle in the top right-hand corner of the Input section.



Toggling between Input and Gain Reduction meters

Channel Strip Output Section

The Output section provides output metering and controls for adjusting the level of the output signal.



Output section (5.1 channel format shown)

Output Volume Control

The Output Volume control sets the output volume after processing, letting you make up gain or prevent clipping on the channel where the Channel Strip plug-in is being used. The Output Volume control can be set to apply at the end of the FX Chain (POST) or before the FX Chain (PRE), see “Channel Strip FX Chain” on page 49.

To adjust the Output Volume, do one of the following:

- Click in the Output Volume field and type a value (–INF dB to +12 dB).
- Click VOL and drag up or down to adjust the Output Volume setting.

Output Meters

The Output meters show peak signal levels after processing:

Dark Blue Indicates nominal levels from –INF to –12 dB.

Light Blue Indicates pre-clipping levels, from –12 dB to 0 dB.

White Indicates full scale levels from 0 dB to +6 dB (which can result in distortion and clipping).

Channel Strip FX Chain

Channel Strip lets you determine the signal path through the available Equalizer (EQ), Filter (FILT), Dynamics (DYN), and Volume (VOL) processing modules. This way you can determine the best signal path for the type of processing you want.

To set the FX Chain:

- 1 Click the FX Chain show/hide button to reveal the Process Order options.



Showing the FX Chain Process Order

- 2 Click an effects chain ordering option to select it. The available options include:
 - EQ > FILT > DYN
 - EQ > DYN > FILT
 - DYN > EQ > FILT
 - FILT > DYN > EQ
- 3 Select PRE or POST to place the Output Volume control at the beginning or at the end of the effects signal chain.

Bypassing or Unbypassing Individual Effects Modules

In the FX Chain display, you can deselect or select individual effects modules to bypass or unbypass the effect.



FX Chain, FILT bypassed

To bypass an effect module:

- Click the module so that it is not highlighted.

To unbypass an effect module:

- Click the module so that it is highlighted.

Channel Strip Dynamics Section

The Dynamics section of Channel Strip provides Expander/Gate, Compressor/Limiter, and Side Chain processing all in one. This section also provides a dynamics graphic display for the Compressor/Limiter and Expander/Gate plug-ins. The display shows a curve that represents the level of the input signal (on the horizontal x-axis) and the amount of gain reduction applied (on the vertical y-axis). The vertical line represents the threshold.



Dynamics section, All tab shown

Dynamics Graph

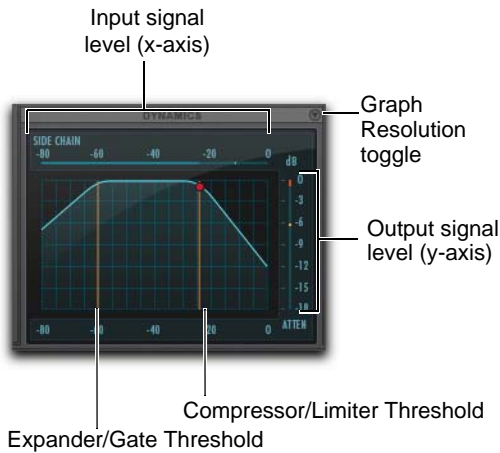

Dynamics graph display

The Dynamics Graph display—used with Expander/Gate and Compressor/Limiter processing—shows a curve that represents the level of the input signal (on the horizontal x-axis) and the amount of gain reduction applied (on the vertical y-axis). The display shows two vertical lines representing the Threshold setting for the Expander/Gate and Compressor/Limiter, respectively.

The Dynamics Graph display also features an animated red ball in the gain transfer curve display. This ball shows the amount of input gain (x-axis) and gain reduction (y-axis) being applied to the incoming signal at any given moment. To indicate overshoots (when an incoming signal peak is too fast for the current compression setting), the cursor temporarily leaves the gain transfer curve.

Use this graph as a visual guideline to see how much dynamics processing you are applying to the incoming audio signal.

Dynamics Graph Gain Reduction Resolution

Channel Strip lets you view the gain reduction scale on the Dynamics Graph display either in 3 dB increments from 0 dB to 18 dB or in 6 dB increments from 0 dB to -36 dB.

To change the Dynamics Graph Gain Reduction resolution:

- Click the Graph Resolution toggle.

Using the Dynamics Graph to Adjust Controls

You can drag in the Dynamics Graph display to adjust the corresponding Expander/Gate and Compressor/Limiter controls. The cursor updates to show which control is being adjusted:

- Expander/Gate Ratio
- Expander/Gate Knee
- Expander/Gate Threshold
- Gate Depth
- Hysteresis
- Compressor/Limiter Ratio
- Compressor/Limiter Knee
- Compressor/Limiter Threshold
- Limiter Depth

 *For the Expander/Gate and Compressor Limiter effects, adjusting a control in the Dynamics Graph display automatically shows the pane that includes the adjusted control if it is not already shown (except when the All tab is shown).*

Expander/Gate Controls



Dynamics section, Expander/Gate tab

Threshold

The Threshold (Thresh) control sets the level below which an input signal must fall to trigger expansion or gating. Signals that fall below the threshold will be reduced in gain. Signals that are above it will be unaffected.

The Dynamics Graph display shows the threshold as a vertical line.

Attack

The Attack control sets the attack time, or the rate at which gain is reduced after the input signal crosses the threshold. Use this along with the Ratio setting to control how soft the Expander's gain reduction curve is.

Ratio

The Ratio control sets the amount of expansion. For example, if this is set to 2:1, it will lower signals below the threshold by one half. At higher ratio levels the Expander/Gate functions like a gate by cutting off signals that fall below the threshold. As you adjust the ratio control, refer to the Dynamics Graph display to see how the shape of the expansion curve changes.

Depth

The Depth control sets the depth of the Expander/Gate when closed. Setting the gate to higher range levels allows more and more of the gated audio that falls below the threshold to peek through the gate at all times.

Hold

The Hold control specifies the duration (in seconds or milliseconds) during which the Expander/Gate will stay in effect after the initial attack occurs. This can be used as a function to keep the Expander/Gate in effect for longer periods of time with a single crossing of the threshold. It can also be used to prevent gate chatter that may occur if varying input levels near the threshold cause the gate to close and open very rapidly.

Release

The Release control sets how long it takes for the gate to close after the input signal falls below the threshold level and the hold time has passed.

Knee

The Knee control sets the rate at which the Expander/Gate reaches full effect once the threshold has been exceeded.

Hysteresis

The Hysteresis (Hyst) control lets you adjust whether or not the gate rapidly opens and closes when the input signal is fluctuating near the Threshold. This can help prevent undesirably rapid gating of the signal. This control is only available when Ratio is set to Gate, otherwise it is greyed out.

Compressor/Limiter Controls



Dynamics section, Compressor/Limiter tab

Threshold

The Threshold control sets the level that an input signal must exceed to trigger compression or limiting. Signals that exceed this level will be compressed. Signals that are below it will be unaffected.

Attack

The Attack control sets the attack time, or the rate at which gain is reduced after the input signal crosses the threshold.

The smaller the value, the faster the attack. The faster the attack, the more rapidly the Compressor/Limiter applies attenuation to the signal. If you use fast attack times, you should generally use a proportionally longer release time, particularly with material that contains many peaks in close proximity.

Ratio

The Ratio control sets the compression ratio, or the amount of compression applied as the input signal exceeds the threshold. For example, a 2:1 compression ratio means that a 2 dB increase of level above the threshold produces a 1 db increase in output. The compression ratio ranges from 1.0:1 to 20.0:1.

Once the Ratio control passes 20.0:1 the Compressor/Limiter effect functions as a limiter rather than a compressor.

At the limiter setting (LMTR), for every decibel that the incoming signal goes over the set Threshold, 1 dB of gain reduction is applied.



Compressor/Limiter Ratio set to LMTR

Once the Ratio control passes the LMTR setting, it provides negative ratio settings from -20.0:1 to 0:1.



Compressor/Limiter Ratio set to a negative value

With these settings, for every decibel that the incoming signal goes over the set Threshold, more than 1 dB of gain reduction is applied according to the negative Ratio setting. For example, at the setting of -1.0:1, for each decibel over the set threshold, 2 db of gain reduction is allied. Consequently, the output signal is both compressed and made softer. You can use this as an creative effect, or as a kind of ducking effect when used with an external key input.

Depth

The Depth control sets the amount of gain reduction that is applied regardless of the input signal. For example, if the Limiter is set at a Threshold of -20 dB and Depth is set at 0 dB, up to 20 dB of gain reduction is applied to the incoming signal (at 0 dB). If you set Depth to -10 dB, no more than 10 dB of gain reduction is applied to the incoming signal.

Release

The **Release** control sets the length of time it takes for the Compressor/Limiter to be fully deactivated after the input signal drops below the threshold.

Release times should be set long enough that if signal levels repeatedly rise above the threshold, the gain reduction “recovers” smoothly. If the release time is too short, the gain can rapidly fluctuate as the compressor repeatedly tries to recover from the gain reduction. If the release time is too long, a loud section of the audio material could cause gain reduction that continues through soft sections of program material without recovering.

Knee

The **Knee** control sets the rate at which the compressor reaches full compression once the threshold has been exceeded.

As you increase this control, it goes from applying “hard-knee” compression to “soft-knee” compression:

- With hard-knee compression, compression begins when the input signal exceeds the threshold. This can sound abrupt and is ideal for limiting.
- With soft-knee compression, gentle compression begins and increases gradually as the input signal approaches the threshold, and reaches full compression after exceeding the threshold. This creates smoother compression.

Gain

The **Gain** control lets you boost overall output gain to compensate for heavily compressed or limited signals.

Side Chain Processing Controls



Dynamics section, Side Chain tab

Dynamics processors typically use the detected amplitude of their input signal to trigger gain reduction. This split-off signal is known as the *side-chain*. Compressor/Limiter and Expander/Gate processing features external key capabilities and filters for the side-chain.

With external key side-chain processing, you trigger dynamics processing using an external signal (such as a separate reference track or audio source) instead of the input signal. This external source is known as the *key input*.

With side-chain filters, you can make dynamics processing more or less sensitive to certain frequencies. For example, you might configure the side-chain so that certain lower frequencies on a drum track trigger dynamics processing.

Source

The **Source** selector lets you set the source for side chain processing: **Internal**, **Key**, or **All-Linked**.

Internal If **Internal** is selected, the plug-in uses the amplitude of the input signal to trigger dynamics processing. With greater-than-stereo multichannel processing, the input signal for each stereo pair effects only those same channels, and likewise mono channels are effected only by their own input signal. For example, with an LCR multichannel format, the processing for the Center channel is only triggered when the Center channel input signal

reaches the threshold. However, when the input signal reaches the threshold on the Left or the Right channel, processing is triggered for both the Left and the Right channel.

Key If Key is selected, the plug-in uses the amplitude of a separate reference track or external audio source to trigger dynamics processing. The reference track used is selected using the Plug-In Key Input selector in the Plug-In window header. With greater-than-stereo multichannel processing, the key signal triggers dynamics processing for all processed audio channels equally.

All-Linked If All-Linked is selected, dynamics processing is applied equally to all channels when the input signal reaches the threshold on any input channel, except for the LFE channel (if present). The LFE channel is processed independently based on its own input signal.



Selecting the Source setting for Side Chain processing
Detection

The Detection options include Peak or Avg (Average).

Peak Select the Peak option to apply side-chain processing according to the detected peak amplitude.

Average Select the Average option to apply side-chain processing according to the detected average amplitude.

Filter Frequency

The Filter Frequency control lets you set the frequency for the selected Filter Type.

Filter Type

Four Filter Type options are available for side-chain processing:

Low Pass Select the Low Pass option to apply a low pass filter to the side-chain processing at the selected frequency.

High Pass Select the High Pass option to apply a high pass filter to the side-chain processing at the selected frequency.

Notch Select the Notch option to apply a notch filter to the side-chain processing at the selected frequency.

Band Pass Select the Band Pass option to apply a band pass filter to the side-chain processing at the selected frequency.

Side Chain Processing Graph

The Side Chain Processing Graph display shows the frequency curve for the selected Filter Type at the selected Filter Frequency.

Channel Strip EQ/Filters Section

The EQ/Filters section of Channel Strip provides a high-quality 4-band parametric equalizer for adjusting the frequency spectrum of audio material.

EQ/Filters Graph

The EQ/Filters section provides an interactive Frequency Graph display that shows the response curve for the current EQ settings on a two-dimensional graph of frequency and gain. The Frequency Graph display also lets you modify frequency, gain, and Q settings for individual EQ bands by dragging their corresponding points in the graph. The Frequency Graph display also plots the frequency, Q, and filter shape of the two filters (when either or both are enabled).

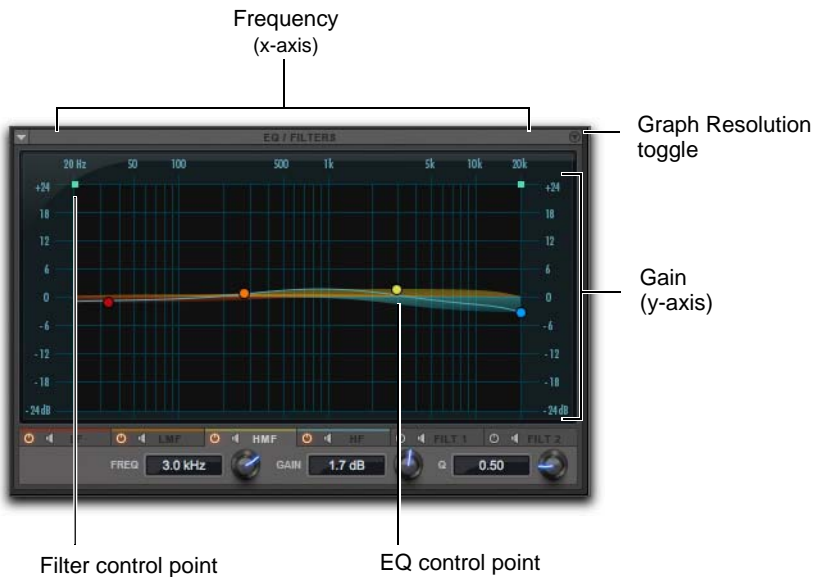

EX/Filters section, High Mid Frequency tab shown

Frequency Graph Gain Resolution

Channel Strip lets you view the gain scale on the Frequency Graph display either in 3 dB increments from -12 dB to +12 dB or in 6 dB increments from -24 dB to +24 dB.

To change the Frequency Graph Gain resolution:

- Click the Graph Resolution toggle.

Dragging in the Frequency Graph to Adjust Controls

You can adjust the following EQ controls by dragging the control points directly in the Frequency Graph display:

Frequency Dragging a control point to the right increases the Frequency setting. Dragging a control point to the left decreases the Frequency setting.

 You can press the Shift key while clicking and dragging an EQ control point up or down to adjust the Gain setting without changing the Frequency. Likewise, press the Shift key while clicking and dragging an EQ control point left or right to adjust the Frequency setting without changing the Gain setting.

Gain Dragging a control point up increases the Gain setting. Dragging a control point down decreases the Gain setting.

 Option-Shift-click (Mac) or Alt-Shift-click (Windows) an EQ control point to invert its Gain setting.

Q Click within the curve of an EQ control point and drag up or down to increase or decrease the Q setting.

 You can also Control-click (Mac) or Start-click (Windows) and drag a control point up or down to increase or decrease the Q setting.

Low Frequency EQ Controls



EQ/Filters section, Low Frequency tab

The LF tab provides controls for the low frequency band of the EQ. The low frequency band can be set to be a Peak or Low Shelf EQ.

EQ Type

Select either the Peak or Low Shelf button to set the EQ type for the low frequency band.

Frequency

The Frequency control lets you set the center frequency for the low frequency band (Peak or Shelf EQ).

Gain

The Gain control lets you boost or attenuate the corresponding frequencies for the low frequency band.

Q

With the low band EQ set to Peak, the Q control changes the width of the EQ band. Higher Q values represent narrower bandwidths. Lower Q values represent wider bandwidths.

With the low band EQ set to Shelf, the Q control changes the Q of the shelving filter. Higher Q values represent steeper shelving curves. Lower Q values represent broader shelving curves.

Low Mid Frequency EQ Controls



EQ/Filters section, Low Mid Frequency tab

The LMF tab provides controls for the low mid frequency band of the EQ. This band is a peak EQ.

Frequency

The Frequency control lets you set the center frequency for the peak low mid frequency band.

Gain

The Gain control lets you boost or attenuate the corresponding frequencies for the low mid frequency band.

Q

The Q control changes the width of the low mid peak EQ band. Higher Q values represent narrower bandwidths. Lower Q values represent wider bandwidths.

High Mid Frequency EQ Controls



EQ/Filters section, High Mid Frequency tab

The HMF tab provides controls for the high mid frequency band of the EQ. This band is a peak EQ.

Frequency

The Frequency control lets you set the center frequency for the peak high mid frequency band.

Gain

The Gain control lets you boost or attenuate the corresponding frequencies for the high mid frequency band.

Q

The Q control changes the width of the high mid peak EQ band. Higher Q values represent narrower bandwidths. Lower Q values represent wider bandwidths.

High Frequency EQ Controls



EQ/Filters section, High Frequency tab

The High Frequency EQ tab provides controls for the high frequency band of the EQ.

Filter Type

The High Frequency band can be set to be a Peak or High Shelf EQ.

Frequency

The Frequency control lets you set the center frequency for the high frequency band (Peak or Shelf EQ).

Gain

The Gain control lets you boost or attenuate the corresponding frequencies for the high frequency band.

Q

With the high band EQ set to Peak, the Q control changes the width of the EQ band. Higher Q values represent narrower bandwidths. Lower Q values represent wider bandwidths.

With the high band EQ set to Shelf, the Q control changes the Q of the shelving filter. Higher Q values represent steeper shelving curves. Lower Q values represent broader shelving curves.

Filter 1 and Filter 2 Controls



EQ/Filters section, Filter 1 tab shown

The Filter 1 and Filter 2 tabs provide the same set of controls for each filter.

Filter Type

Both Filter 1 and Filter 2 can be set independently. Select from the following Filter Type options: High Pass, Low Pass, Band Pass, and Notch.

Frequency

The Frequency control lets you set the center frequency for the selected Filter Type (from 20 Hz to 21.0 kHz).

Slope

When the Filter Type is set to Low Pass or High Pass, the Slope control is available. The Slope control lets you set the slope for the filter from the selected Frequency to $-\infty$ (12 dB/O or 24 dB/O).

Q

When the Filter Type is set to Band Pass or Notch, the Q control is available. The Q control changes the width of the filter around the center frequency band. Higher Q values represent narrower bandwidths. Lower Q values represent wider bandwidths.

Chapter 12: Dynamics III

Dynamics III is a suite of three dynamics plug-ins available in DSP, Native, and AudioSuite formats:

- Compressor/Limiter (see “Compressor/Limiter III” on page 62)
- Expander/Gate (see “Expander/Gate III” on page 65)
- De-Esser (see “De-Esser III” on page 68)

Dynamics III supports 44.1 kHz, 48 kHz, 88.2 kHz, 96 kHz, 176.4 kHz and 192 kHz sample rates.

The Compressor/Limiter and Expander/Gate modules support mono, stereo, and greater-than-stereo multichannel formats up to 7.1.

! *Greater-than-stereo formats are only available with Pro Tools HD.*

The De-Esser module supports mono and stereo formats only.

In addition to standard controls in each module, Dynamics III also provides a graph to track the gain transfer curve in the Compressor/Limiter and Expander/Gate plug-ins, and a frequency graph to display which frequencies trigger the De-Esser and which frequencies will be gain reduced.

Dynamics III Common Controls

The Levels section, the LFE Enable button, and the Dynamics Graph display of the user interface are shared between the Compressor/Limiter, Expander/Gate, and De-Esser plug-ins.

Dynamics III Levels Section

The indicators and controls in the Dynamic III Levels section let you track input, output, and gain reduction levels, as well as work with phase invert and the threshold setting.

 See “De-Esser III Level Meters” on page 68 for more information on De-Esser III Input/Output Level controls.

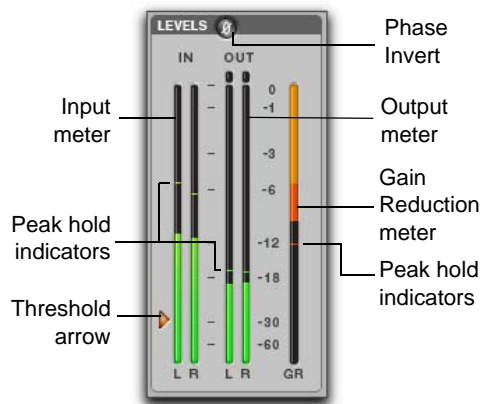

I/O Meter display (stereo instance shown)

Input and Output Meters

The Input (In) and Output (Out) meters show peak signal levels before and after dynamics processing:

Green Indicates nominal levels.

Yellow Indicates pre-clipping levels, starting at -6 dB below full scale.

Red Indicates full scale levels (clipping).

The clip indicators at the top of the Output meters indicate clipping at the input or output stage of the plug-in. Clip indicators can be cleared by clicking the indicator.

 *The Input and Output meters display differently depending on the type of track (mono, stereo, or multichannel) on which the plug-in has been inserted.*

 *When Side-Chain Listen is enabled, the Output meter only displays the levels of the side-chain signal. See “Dynamics III Side-Chain Listen” on page 71.*

Toggleing Multichannel Input and Output Meters

With multichannel track types LCRS and higher, both Input and Output meters cannot be shown at the same time. Click either the Input or Output button to display the appropriate level meter. The Input/Output meters display is toggled to Output by default.



Input (left) and Output (right) meter buttons

Gain Reduction Meter

The Gain Reduction (GR) meter indicates the amount the input signal is attenuated (in dB) and shows different colors during dynamics processing:

Light Orange Indicates that gain reduction is within the “knee” and has not reached the full ratio of compression.

Dark Orange Indicates that gain reduction is being applied at the full ratio (for example, 2:1).

Threshold Arrow

The orange Threshold arrow next to the Input meter indicates the current threshold, and can be dragged up or down to adjust the threshold. When a multichannel instance of the plug-in has been configured to show only the Output meter, the Threshold arrow is not displayed.

Phase Invert

The Phase Invert button at the top of the Levels section inverts the phase (polarity) of the input signal, to help compensate for phase anomalies that can occur either in multi-microphone environments or because of mis-wired balanced connections.

Dynamics III LFE Enable (Pro Tools HD Only)

The LFE Enable button (located in the Options section) is on by default, and enables plug-in processing of the LFE (low frequency effects) channel on a multichannel track formatted for 5.1, 6.1, or 7.1 surround formats. To disable LFE processing, deselect this button.



LFE Enable button (Compressor/Limiter III shown)

 *The LFE Enable button is not available if the plug-in is not inserted on an applicable track.*

Dynamics III Graph Display

The Dynamics Graph display—used with the Compressor/Limiter and Expander/Gate plug-ins—shows a curve that represents the level of the input signal (on the horizontal x-axis) and the level of the output signal (on the vertical y-axis). The orange vertical line represents the threshold.

Use this graph as a visual guideline to see how much dynamics processing you are applying.

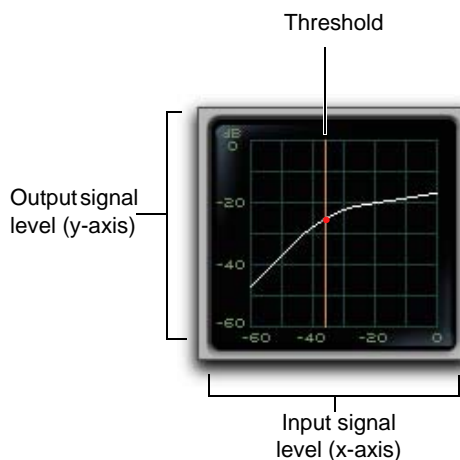

Dynamics graph display

The Compressor/Limiter and Expander/Gate plug-ins also feature an animated, multi-color cursor in their gain transfer curve displays.

The gain transfer curve of the Compressor/Limiter and Expander/Gate plug-ins shows a moving ball cursor that shows the amount of input gain (x-axis) and gain reduction (y-axis) being applied to the incoming signal.

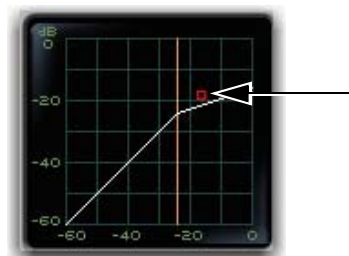

Gain transfer curve and cursor showing amount of compression

To indicate overshoots (when an incoming signal peak is too fast for the current compression setting) the cursor temporarily leaves the gain transfer curve.

The cursor changes color to indicate the amount of compression applied, as shown in the following table:

Cursor Color	Compression Amount
white	no compression
light orange	below full ratio
dark orange	full ratio amount

 See “De-Esser III Frequency Graph Display” on page 69 for information on using the De-Esser graph display.

Dynamics III Side-Chain Section

For information on using the Side-Chain section of the Compressor/Limiter or Expander/Gate, see “Using Dynamics III Key Input for Side-Chain Processing” on page 73.

Compressor/Limiter III

The Compressor/Limiter plug-in applies either compression or limiting to audio material, depending on the ratio of compression used.



Compressor/Limiter III

About Compression

Compression reduces the dynamic range of signals that exceed a chosen threshold by a specific amount. The Threshold control sets the level that the signal must exceed to trigger compression. The Attack control sets how quickly the compressor responds to the “front” of an audio signal once it crosses the selected threshold. The Release control sets the amount of time that it takes for the compressor’s gain to return to its original level after the input signal drops below the selected threshold.

To use compression most effectively, the attack time should be set so that signals exceed the threshold level long enough to cause an increase in the average level. This helps ensure that gain reduction does not decrease the overall volume too drastically, or eliminate desired attack transients in the program material.

Of course, compression has many creative uses that break these rules.

About Limiting

Limiting prevents signal peaks from ever exceeding a chosen threshold, and is generally used to prevent short-term peaks from reaching their full amplitude. Used judiciously, limiting produces higher average levels, while avoiding overload (clipping or distortion), by limiting only some short-term transients in the source audio. To prevent the ear from hearing the gain changes, extremely short attack and release times can be used.

Limiting is used to remove only occasional peaks because gain reduction on successive peaks would be noticeable. If audio material contains many peaks, the threshold should be raised and the gain manually reduced so that only occasional, extreme peaks are limited.

Limiting generally begins with the ratio set at 10:1 and higher. Large ratios effectively limit the dynamic range of the signal to a specific value by setting an absolute ceiling for the dynamic range.

Compressor/Limiter III Input/Output Level Meters

The Input and Output meters show peak signal levels before and after dynamics processing. See “Dynamics III Levels Section” on page 59 for more information.

Unlike scales on analog compressors, metering scales on a digital device reflect a 0 dB value that indicates full scale (fs)—the full-code signal level.

Compressor/Limiter III Graph Display

The Dynamics Graph display lets you visually see how much expansion or gating you are applying to your audio material. See “Dynamics III Graph Display” on page 61.

Compressor/Limiter III Threshold Control

The Threshold (Thresh) control sets the level that an input signal must exceed to trigger compression or limiting. Signals that exceed this level will be compressed. Signals that are below it will be unaffected.

This control has an approximate range of -60 dB to 0 dB, with a setting of 0 dB equivalent to no compression or limiting. The default value for the Threshold control is -24 dB.

An orange arrow on the Input meter indicates the current threshold, and can also be dragged up or down to adjust the threshold setting.



Threshold arrow on input meter

The Dynamics Graph display also shows the threshold as an orange vertical line.

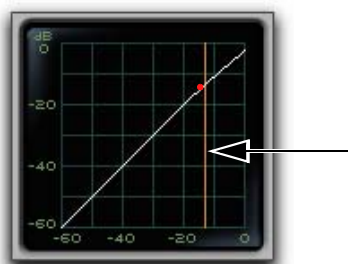

Threshold indicator on Dynamics Graph display

This control ranges from -60 dB (lowest gain) to 0 dB (highest gain).

Compressor/Limiter III Ratio Control

The Ratio control sets the compression ratio, or the amount of compression applied as the input signal exceeds the threshold. For example, a 2:1 compression ratio means that an input level that is 2 dB above the threshold will be attenuated, resulting in an output level that is 1 dB over the threshold.

This control ranges from 1:1 (no compression) to 100:1 (hard limiting).

Compressor/Limiter III Attack Control

The Attack control sets the attack time, or the rate at which gain is reduced after the input signal crosses the threshold.

The smaller the value, the faster the attack. The faster the attack, the more rapidly the Compressor/Limiter applies attenuation to the signal. If you use fast attack times, you should generally use a proportionally longer release time, particularly with material that contains many peaks in close proximity.

This control ranges from 10 μ s (fastest attack time) to 300 ms (slowest attack time).

Compressor/Limiter III Release Control

The Release control sets the length of time it takes for the Compressor/Limiter to be fully deactivated after the input signal drops below the threshold.

Release times should be set long enough that if signal levels repeatedly rise above the threshold, the gain reduction “recovers” smoothly. If the release time is too short, the gain can rapidly fluctuate as the compressor repeatedly tries to recover from the gain reduction. If the release time is too long, a loud section of the audio material could cause gain reduction that continues through soft sections of program material without recovering.

This control ranges from 5 ms (fastest release time) to 4 seconds (slowest release time).

Compressor/Limiter III Knee Control

The Knee control sets the rate at which the compressor reaches full compression once the threshold has been exceeded.

As you increase this control, it goes from applying “hard-knee” compression to “soft-knee” compression:

- With hard-knee compression, compression begins when the input signal exceeds the threshold. This can sound abrupt and is ideal for limiting.
- With soft-knee compression, gentle compression begins and increases gradually as the input signal approaches the threshold, and reaches full compression after exceeding the threshold. This creates smoother compression.



Graph examples of hard knee (left) and soft knee (right) compression

For example, a Knee setting of 10 dB would be the gain range over which the ratio gradually increased to the set ratio amount.

The Gain Reduction meter displays light orange while gain reduction has not exceeded the knee setting, and switches to dark orange when gain reduction reaches the full ratio.

This control ranges from 0 db (hardest response) to 30 db (softest response).

Compressor/Limiter III Gain Control

The Gain control lets you boost overall output gain to compensate for heavily compressed or limited signals.

This control ranges from 0 dB (no gain boost) to +40 dB (loudest gain boost), with the default value at 0 dB.

 For more information on the LFE channel, refer to the *Pro Tools Reference Guide*.

Compressor/Limiter III Side-Chain Section

The *side-chain* is the split-off signal used by the plug-in's detector to trigger dynamics processing. The Side-Chain section lets you toggle the side-chain between the internal input signal or an external key input, and tailor the equalization of the side-chain signal so that the triggering of dynamics processing becomes frequency-sensitive. See “Dynamics III Side-Chain Input” on page 70.

Expander/Gate III

The Expander/Gate plug-in applies expansion or gating to audio material, depending on the ratio setting.



Expander/Gate III

About Expansion

Expansion decreases the gain of signals that fall below a chosen threshold. They are particularly useful for reducing noise or signal leakage that creeps into recorded material as its level falls, as often occurs in the case of headphone leakage.

About Gating

Gating silences signals that fall below a chosen threshold. To enable gating, simply set the Ratio and Range controls to their maximum values.

Expanders can be thought of as soft noise gates since they provide a gentler way of reducing noisy low-level signals than the typically abrupt cutoff of a gate.

Expander/Gate III Input/Output Level Meters

The Input and Output meters show peak signal levels before and after dynamics processing. See “Dynamics III Levels Section” on page 59 for more information.

Expander/Gate III Dynamics Graph Display

The Dynamics Graph display lets you visually see how much expansion or gating you are applying to your audio material. See “Dynamics III Graph Display” on page 61.

Expander/Gate III Look Ahead Button

Normally, dynamics processing begins when the level of the input signal crosses the threshold. When the Look Ahead button is enabled, dynamics processing begins 2 milliseconds before the level of the input signal crosses the threshold.



Look Ahead control

The Look Ahead control is useful for avoiding the loss of transients that may have been otherwise cut off or trimmed in a signal.

Expander/Gate III Threshold Control

The Threshold (Thresh) control sets the level below which an input signal must fall to trigger expansion or gating. Signals that fall below the threshold will be reduced in gain. Signals that are above it will be unaffected.

An orange arrow on the Input meter indicates the current threshold, and can also be dragged up or down to adjust the threshold setting.

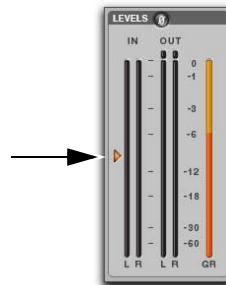

Threshold arrow on Input meter

The Dynamics Graph display also shows the threshold as an orange vertical line.

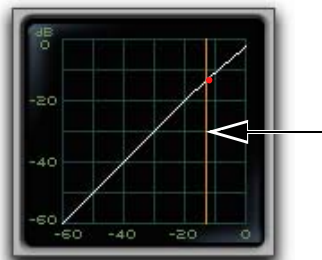

Threshold indicator on Dynamics Graph display

This control has an approximate range of -60 dB to 0 dB, with a setting of 0 dB equivalent to no compression or limiting. The default value for the Threshold control is -24 dB.

Expander/Gate III Ratio Control

The Ratio control sets the amount of expansion. For example, if this is set to 2:1, it will lower signals below the threshold by one half. At higher ratio levels (such as 30:1 or 40:1) the Expander/Gate functions like a gate by cutting off signals that fall below the threshold. As you adjust the ratio control, refer to the built-in graph to see how the shape of the expansion curve changes.

This control ranges from 1:1 (no expansion) to 100:1 (gating).

Expander/Gate III Attack Control

The Attack control sets the attack time, or the rate at which gain is reduced after the input signal crosses the threshold. Use this along with the Ratio setting to control how soft the Expander's gain reduction curve is.

This control ranges from 10 μ s (fastest attack time) to 300 ms (slowest attack time).

Expander/Gate III Hold Control

The Hold control specifies the duration (in seconds or milliseconds) during which the Expander/Gate will stay in effect after the initial attack occurs. This can be used as a function to keep the Expander/Gate in effect for longer periods of time with a single crossing of the threshold. It can also be used to prevent gate chatter that may occur if varying input levels near the threshold cause the gate to close and open very rapidly.

This control ranges from 5 ms (shortest hold) to 4 seconds (longest hold).

Expander/Gate III Release Control

The Release control sets how long it takes for the gate to close after the input signal falls below the threshold level and the hold time has passed.

This control ranges from 5 ms (fastest release time) to 4 seconds (slowest release time).

Expander/Gate III Range Control

The Range control sets the depth of the Expander/Gate when closed. Setting the gate to higher range levels allows more and more of the gated audio that falls below the threshold to peek through the gate at all times.

This control ranges from -80 dB (lowest depth) to 0 dB (highest depth).

Expander/Gate III Side-Chain Section

The *side-chain* is the split-off signal used by the plug-in's detector to trigger dynamics processing. The Side-Chain section lets you toggle the side-chain between the internal input signal or an external key input, and tailor the equalization of the side-chain signal so that the triggering of dynamics processing becomes frequency-sensitive. See "Dynamics III Side-Chain Input" on page 70.

De-Esser III

The De-Esser reduces sibilants and other high frequency noises that can occur in vocals, voice-overs, and wind instruments such as flutes. These sounds can cause peaks in an audio signal and lead to distortion.

The De-Esser reduces these unwanted sounds using fast-acting, frequency-dependent compression. The Threshold control sets the level above which compression starts, and the Frequency (Freq) control sets the frequency band in which the De-Esser operates.



De-Esser III

Using De-Essing Effectively

To use de-essing most effectively, insert the De-Esser after compressor or limiter plug-ins.

The Frequency control should be set to remove sibilants (typically the 4–10 kHz range) and not other parts of the signal. This helps prevent de-essing from changing the original character of the audio material in an undesired manner.

Similarly, the Range control should be set to a level low enough so that de-essing is triggered only by sibilants. If the Range is set too high, a loud, non-sibilant section of audio material could cause unwanted gain reduction or cause sibilants to be over-attenuated.

To improve de-essing of material that has both very loud and very soft passages, automate the Range control so that it is lower on soft sections.

 *The De-Esser has no control to directly adjust the threshold level (the level that an input signal must exceed to trigger de-essing). The amount of de-essing will vary with the input signal.*

De-Esser III Level Meters

These controls let you track input, output, and gain reduction levels.

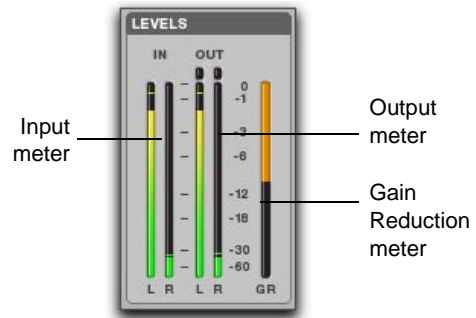

De-Esser III I/O Meter display

Input and Output Meters

The Input and Output meters show peak signal levels before and after dynamics processing:

Green Indicates nominal levels.

Yellow Indicates pre-clipping levels, starting at -6 dB below full scale.

Red Indicates full scale levels (clipping).

The Clip indicators at the top of each meter indicate clipping at the input or output stage of the plug-in. Clip indicators can be cleared by clicking the indicator.

De-Esser III Gain Reduction Meter

The Gain Reduction meter indicates the amount the input signal is attenuated, in dB. This meter shows different colors during de-essing:

Light Orange Indicates that gain reduction is being applied, but has not reached the maximum level set by the Range control.

Dark Orange Indicates that gain reduction has reached the maximum level set by the Range control.

De-Esser III Frequency Control

The Frequency (Freq) control sets the frequency band in which the De-Esser operates. When HF Only is disabled, gain is reduced in frequencies within the specified range. When HF Only is enabled, the gain of frequencies above the specified value will be reduced.

This control ranges from 500 Hz (lowest frequency) to 16 kHz (highest frequency).

De-Esser III Range Control

The Range control defines the maximum amount of gain reduction possible when a signal is detected at the frequency set by the Frequency control.

This control ranges from -40 dB (maximum de-essing) to 0 dB (no de-essing).

De-Esser III HF Only Control

When the HF Only button is enabled, gain reduction is applied only to the active frequency band set by the Frequency control. When the HF Only button is disabled, the De-Esser applies gain reduction to the entire signal.

De-Esser III Listen Control

When enabled, the Listen button lets you monitor the sibilant peaks used by the De-Esser as a side-chain to trigger compression. This is useful for listening only to the sibilance for fine-tuning De-Esser controls. To monitor the whole output signal without this filtering, deselect the Listen button.

De-Esser III Frequency Graph Display

The De-Esser Frequency Graph display shows a curve that represents the level of gain reduction (on the y-axis) for the range of the output signal's frequency (on the x-axis). The white line represents the current Frequency setting, and the animated orange line represents the level of gain reduction being applied to the signal.

Use this graph as a visual guideline to see how much dynamics processing you are applying at different points in the frequency spectrum.

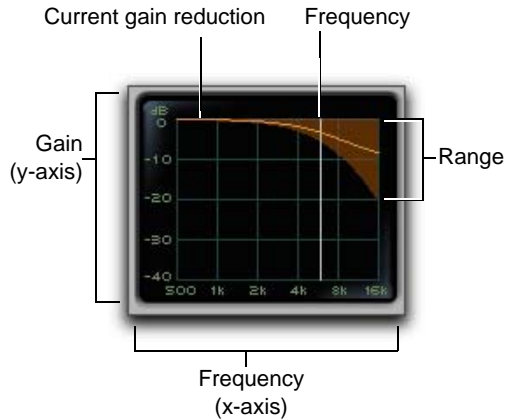

De-Esser graph display

Dynamics III Side-Chain Input (Compressor/Limiter and Expander/Gate Only)

Dynamics processors typically use the detected amplitude of their input signal to trigger gain reduction. This split-off signal is known as the *side-chain*. The Compressor/Limiter and Expander/Gate plug-ins feature external key capabilities and filters for the side-chain.

With external key side-chain processing, you trigger dynamics processing using an external signal (such as a separate reference track or audio source) instead of the input signal. This external source is known as the *key input*.

With side-chain filters, you can make dynamics processing more or less sensitive to certain frequencies. For example, you might configure the side-chain so that certain lower frequencies on a drum track trigger dynamics processing.

Dynamics III Side-Chain Controls

The controls in the Side-Chain section let you toggle the side-chain between the internal input signal or an external key input, listen to the side-chain, and tailor the equalization of the side-chain signal so that the triggering of dynamics processing becomes frequency-sensitive.



Compressor/Limiter and Expander/Gate Side-Chain

Dynamics III Side-Chain External Key

The External Key toggles external side-chain processing on or off. When this button is highlighted, the plug-in uses the amplitude of a separate reference track or external audio source to trigger dynamics processing. When this button is dark gray, the External Key is disabled and the plug-in uses the amplitude of the input signal to trigger dynamics processing.



External Key button

Dynamics III Side-Chain Listen

When enabled, this control lets you listen to the internal or external side-chain input by itself, as well as monitor its levels with the Output meter. This is especially useful for fine-tuning the plug-in's filter settings or external key input.



Side-Chain Listen button

⚠ *Side-Chain Listen is not saved with other plug-in presets.*

Dynamics III Side-Chain HF and LF Filter Enable Buttons

The HF Filter Enable and LF Filter Enable buttons toggle the corresponding filter in or out of the side-chain. When this button is highlighted, the filter is applied to the side-chain signal. When this button is dark gray, the filter is bypassed and available for activation.



HF and LF Filter Enable buttons

Dynamics III Side-Chain High-Frequency (HF) Filter Type

The HF filter section lets you filter higher frequencies out of the side-chain signal so that only certain bands of high frequencies or lower frequencies pass through to trigger dynamics processing. The HF side-chain filter is switchable between Band Pass and Low Pass filters.

Band Pass Filter Makes triggering of dynamics processing more sensitive to frequencies within the narrow band centered around the Frequency setting, and rolling off at a slope of 12 dB per octave.



Band-Pass filter

Low Pass Filter Makes triggering of dynamics processing more sensitive to frequencies below the Frequency setting rolling off at a slope of 12 dB per octave.



Low Pass filter

Dynamics III Side-Chain HF Frequency Control

The HF frequency control sets the frequency position for the Band Pass or Low Pass filter, and ranges from 20 Hz to 20 kHz.



HF frequency controls

Dynamics III Side-Chain Low-Frequency (LF) Filter Type

The LF filter section lets you filter lower frequencies out of the side-chain signal so that only certain bands of low frequencies or higher frequencies are allowed to pass through to trigger dynamics processing. The LF side-chain is switchable between Band Pass and High Pass filters.

Band-Pass Filter Makes triggering of dynamics processing more sensitive to frequencies within the narrow band centered around the Frequency setting, and rolling off at a slope of 12 dB per octave.



Band-Pass filter

High Pass Filter Makes triggering of dynamics processing more sensitive to frequencies above the Frequency setting rolling off at a slope of 12 dB per octave.



High Pass filter

Dynamics III Side-Chain LF Frequency Control

The Frequency control sets the frequency position for the Band-Pass or High Pass filter, and ranges from 20 Hz to 20 kHz.



LF frequency controls

Using Dynamics III Key Input for Side-Chain Processing

To use a filtered or unfiltered external key input to trigger dynamics processing:

- 1 Click the Key Input selector and select the input or bus carrying the audio from the reference track or external audio source.

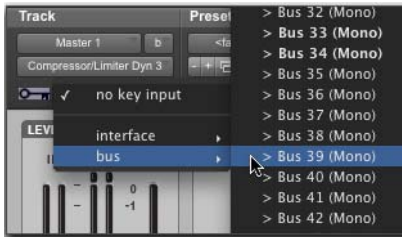

Selecting a Key Input

- 2 Click External Key to activate external side-chain processing.



External Key

- 3 To listen to the signal that will be used to control side-chain input, click Side-Chain Listen to enable it (highlighted).



Side-Chain Listen

- 4 To filter the key input so that only specific frequencies trigger the plug-in, use the HF and LF controls to select a frequency range.
- 5 Begin playback. The plug-in uses the input or bus that you chose as an external key input to trigger its effect.
- 6 Adjust the plug-in's Threshold (Thresh) control to fine-tune external key input triggering.

Using a Filtered Input Signal for Side-Chain Processing with Dynamics III

To use the filtered input signal to trigger dynamics processing:

- 1 Ensure the Key Input selector is set to No Key Input.

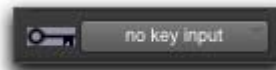

Key Input selector

- 2 Ensure that the External Key button is disabled (dark gray).



Side-Chain section

- 3 To listen to the signal that will be used to control side-chain input, click Side-Chain Listen to enable it (highlighted).



Side-Chain section

- 4 To filter the side-chain input so that only specific frequencies within the input signal trigger the plug-in, use the HF and LF controls to select a frequency range.
- 5 Begin playback. The plug-in uses the filtered input signal to trigger dynamics processing.
- 6 To fine-tune side-chain triggering, adjust the plug-in controls.

Chapter 13: Fairchild Plug-Ins

The Fairchild plug-ins are a pair of vintage compressor plug-ins that are available in DSP, Native, and AudioSuite formats.

The Fairchild plug-ins support 44.1 kHz, 48 kHz, 88.2 kHz, 96 kHz, 176.4 kHz and 192 kHz sample rates.

The Fairchild plug-ins operate as mono, multi-mono, or stereo plug-ins.

Fairchild 660

Re-introducing the undisputed champion in price, weight, and performance: the \$35,000, one-hundred pound, Fairchild 660. Avid's no-compromise replica captures every detail of this studio classic.

Designed in the early 1950s, the Fairchild 660 is a variable- μ tube limiter. Variable- μ designs use an unusual form of vacuum tube that is capable of changing its gain dynamically.

The result? In addition to featuring a tube audio stage like the LA-2A, the Fairchild actually achieves gain reduction through the use of tubes!



Fairchild 660

The heart of the Fairchild limiter—a 6386 triode—is one such variable- μ tube. In fact, four of these tubes are used in parallel. A key part of the Fairchild design, it ensures that the output doesn't get darker as the unit goes further into gain reduction, and also reduces distortion as the tubes are biased further into Class-B operation.



Tubes, wires, and iron

Fairchild 660 Controls

Adjust the Input Gain and Threshold controls together until you get the sound you want. Like many classic compressors, after a little bit of tweaking, you'll know immediately when you get it right.

Input Gain Input Gain sets the input level to the unit and the compression threshold, just like the Input control on an 1176. Full clockwise is loudest.

Threshold Threshold adjusts the gain to the side-chain, just like the Peak Reduction control on an LA-2A.

Time Constant Selects the attack and release times for the compressor. One is fastest, and six is slowest. Seven and eight are custom presets.

Fairchild 660 Tips and Tricks

5,6,7,8...

The Fairchild manual documents Time Constant settings 5 and 6 as user presets—although you have to go inside with a soldering iron to change them. We used the “factory default” values.

Bonus Settings

Settings 7 and 8 do not exist on real-world units—well, at least most of them. These settings are taken from a real-world Fairchild modification invented by Dave Amels many years before he designed the plug-in version.

What do they do? Settings 7 and 8 offer versions of Time Constant 2 with a gentler release useful for compressing vocals and other program material where you desire more subtlety in the compression action. Give them a try—you've already heard them on hit songs on the radio.

Pump It Up

With a carefully adjusted Input Gain and Threshold, you can use Time Constant 1 to achieve a cool pumping effect on drums. The sound gets darker and fuller, and sits beautifully in a mix.

Fairchild 670

Avid's no-compromise replica captures every detail of the Fairchild 670. The Fairchild 670 is a dual-channel unit and, as such, is only available on stereo tracks.

Note that the companion Fairchild 660 also supports stereo operation. Both a Fairchild 660 and a Fairchild 670 were modeled from scratch using two different hardware units. This gives you a choice of two different-sounding Fairchild units to try on your stereo tracks!



Fairchild 670

The internal design of the Fairchild 670 is similar to the Fairchild 660. However, the Fairchild 670 offers two channels of compression instead of one. Combined with the AGC control, this gives you even more compression options on stereo tracks.

Fairchild 670 Controls

Adjust the Input Gain and Threshold controls together on both channels until you get the sound you want. Like many classic compressors, after a little bit of tweaking, you'll know immediately when you get it right.

Input Gain Sets the input level to the unit and the compression threshold, just like the Input control on an 1176. Full clockwise is loudest.

Threshold Adjusts the gain to the sidechain, just like the Peak Reduction control on an LA-2A.

Time Constant Selects the attack and release times. One is fastest, and six is slowest. Seven and eight are custom presets. See “Fairchild 670” on page 77 for details on these custom settings.

AGC Lets you select Left/Right processing or Lat/Vert processing of the two channels. Left/Right works like a dual-mono compressor with separate controls for the left and right channels. In Lat/Vert mode the top row of controls affects the in-phase (Lat) information and the bottom row of controls affects the out of phase (Vert) information. Although originally designed for vinyl mastering where excess Vert (vertical) information could cause the needle to jump out of the groove, you can use the Lat/Vert mode to achieve some amazing effects – especially on drums.

Fairchild 670 Tips and Tricks

To exactly match the settings between channels, hold down the Shift key while adjusting a control. This is useful when trying to preserve the existing Left/Right balance on stereo material.

Chapter 14: Focusrite D3

Focusrite D3 is a high-quality dynamics processor plug-in. Developed in cooperation with Focusrite, the D3 is based on the highly acclaimed Red Range 3™ dual mono/stereo compressor & limiter designed by Rupert Neve.

D3 is available in DSP, Native, and AudioSuite formats.

D3 supports 44.1 kHz, 48 kHz, 88.2 kHz, 96 kHz, 176.4 kHz and 192 kHz sample rates.

D3 operates as a mono, multi-mono, or stereo plug-in.



Focusrite D3

D3 features include:

- ◆ **Compressor+Limiter.** This configuration allows you to use both the compressor and the limiter at the same time. The Compressor+Limiter plug-in requires twice as much DSP as the Compressor/Limiter.

- ◆ **Compressor/Limiter.** This configuration allows you to use either the compressor or the limiter—but not both at the same time. The Compressor/Limiter plug-in uses half as much DSP as the Compressor+Limiter. It is provided so that you can conserve DSP, since you may not need both compression and limiting at the same time.

The Compressor/Limiter defaults to the compressor being enabled and the limiter disabled.

D3 Compressor

The D3 compressor reduces the dynamic range of audio signals that exceed a user-selectable threshold by a specific amount. This is accomplished by reducing output levels as input levels increase above the threshold.

The amount of output level reduction that D3 applies as input levels increase is referred to as the *compression ratio*. This parameter is adjustable. If you set the compression ratio to 2:1, for example, for each 2 dB that the signal exceeds the threshold, the output level will be reduced to 1 dB above the threshold. With a compression ratio of 4:1, an 8 dB increase in input will produce only a 2 dB increase in output.

D3 Limiter

The D3 limiter operates as a fast-attack compressor with a high compression ratio. It does not attack instantaneously or look ahead in order to attack ahead of time, but instead uses a very fast, 1-millisecond attack time. As such, the D3 is not a “brick wall” limiter, but limits the overall dynamic range of signals in a sonically-pleasing way.

Like the Compressor, the Limiter is activated when the signal exceeds the user-selected threshold. The Limiter then compresses any signal above the selected threshold down to the threshold limit that you have set.

To enable the limiter:

- 1 Disable the compressor by Control-clicking (Mac) or Start-clicking (Windows) its icon.
- 2 Click the Limiter icon.

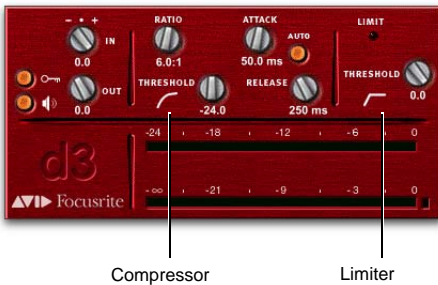

Compressor and Limiter icons

D3 Side-Chain Processing

Compressors and limiters generally use the detected amplitude of the input signal as a control source. Other signals can also be used as a control source by using a key input. With de-essing, for example, a frequency-modified version of the input signal is used as a trigger. This is known as side-chain processing.

Side-chain processing allows the D3 compression or limiting to be controlled by another independent audio signal. In this way you can compress or limit one track’s audio using the dynamics of a different track’s audio.

Using D3 in Stereo

In stereo configurations, all D3 controls except the Input Level affect both channels of the stereo signal. The D3 RMS detector (which derives the control signal that drives the dynamics processing) uses a composite of the two channels. Because of this, when stereo processing occurs, there is no image shift when signal levels differ between the two channels (since the composite control signal drives processing for both channels).

D3 Common Controls

Input Level

Input Level attenuates signal input level to the compressor or limiter. The range of this control is from -30 dB to 0 dB.

When you use the stereo version of the D3 plug-in, each channel has its own separate Input Level knob. To adjust input levels for both channels simultaneously, Shift-drag. Option-Shift clicking (Mac) or Alt-Shift-clicking (Windows) either Input Level knob resets both channels to 0 dB.



Input Level

Output Level

Output Level adjusts the overall output gain. Because large amounts of compression can restrict dynamic range, the Output Level knob is useful for compensating for heavily compressed signals and making up the resulting difference in level.

When you use the stereo version of the D3 plug-in, this single knob controls the master output for both channels. The range of this control is from -12 dB of attenuation to $+18$ dB of gain.



Output Level

External Key and Key Listen

The *side-chain* is the split-off signal used by a plug-in's detector to trigger dynamics processing. External Key lets you designate an external source (known as the *key input*) for the side-chain, while Key Listen lets you monitor the key input.

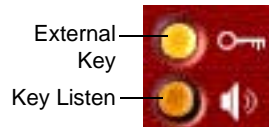

External Key and Key Listen toggles

 See “Using the Side-Chain Input in D3” on page 84 for detailed information on external side-chain processing.

Meters

The meters indicate gain reduction (the top meter) and output level (the bottom meter). The Gain Reduction meter indicates the amount of gain reduction in dB. The Output Level meter indicates the output signal level in dB.

In Stereo mode, two Output Level meters appear, one for each channel. However, a single Gain Reduction meter is used for both channels, since the D3 RMS detector uses a composite control signal.

A red Clip Indicator appears to the right of the output meter(s). Clicking on the Clip Indicator clears it. Option-clicking (Mac) or Alt-clicking (Windows) clears both channels when the plug-in is used in stereo.

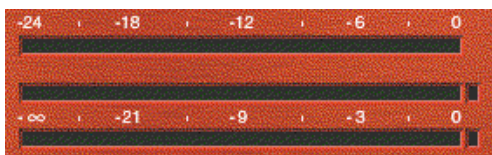

Meters

The following metering indications are used:

- Green = nominal levels
- Yellow = pre-clipping at -6 dB below full scale signal
- Red = full scale signal (clipping)

D3 Compressor Controls

The Compressor icon, which represents a compression curve, acts as a three-state switch for enabling, disabling, or bypassing the compressor. Its current state is indicated by the icon's color.



Compressor icon

- White indicates enabled. In this state the compressor is active and using available DSP resources.
- Black indicates disabled. In this state, the compressor is not using DSP resources.
- Gray indicates bypassed. In this state the compressor is not active, but is still using available DSP resources.



Compressor controls

To disable the compressor:

- Control-click (Mac) or Start key-click (Windows) the icon. When the compressor is disabled, the icon is black.

To re-enable the compressor:

- Click the icon. When the compressor is enabled, the icon is white.

To bypass the compressor:

- Click the icon a second time. When the compressor is bypassed, the icon is gray.

If you are using the Compressor/Limiter plug-in, which allows you to use either the compressor or the limiter (but not both simultaneously), you must disable one module by Control-clicking (Mac) or Start-clicking (Windows) the icon before you can enable the other.

Ratio

Ratio sets the compression ratio. If the ratio is set to 2:1 for example, it will compress changes in signals above the threshold by one half. The range of this control is from 1.5:1 (very little compression), to 10:1 (heavy compression, bordering on limiting).



Ratio

Threshold

Threshold sets the threshold level. Signals that exceed this level will be compressed. Signals that are below it will be unaffected. The range of this control is from 0 dB to -48 dB. A setting of 0 dB is equivalent to no compression.



Threshold

Attack

Attack sets the compressor attack time. To use compression most effectively, the attack time should be set so that signals exceed the threshold level long enough to cause an increase in the average level. This helps ensure that gain reduction doesn't decrease the overall volume. The range of this control is from 1.0 ms to 150.0 ms.



Attack

Release

Release controls how long it takes for the compressor to be fully deactivated after the input signal drops below the threshold level. In general, this setting should be longer than the attack time and long enough that if signal levels repeatedly rise above the threshold, they cause gain reduction only once. If the release time is too long, a loud section of the audio material could cause gain reduction that persists through a soft section. The range of this control is from 25 milliseconds to 2.5 seconds.



Auto Release

Auto Release

Auto Release enables the automatic release function. In this mode the Release control has no effect on release time. Instead, the D3 uses a release time value that is program dependent and based on the audio being processed.



Auto Release

D3 Limiter Controls

The Limiter icon, which represents a limiter curve, acts as a three-state switch for enabling, disabling, or bypassing the limiter. Its current state is indicated by the icon's color:

- White indicates enabled. In this state, the limiter is active and using available DSP resources.
- Black indicates disabled. In this state, the limiter is not using DSP resources.
- Gray indicates bypassed. In this state, the limiter is not active, but is still using available DSP resources.



Limiter controls



Limiter In/Out icon

To disable the limiter:

- Control-click (Mac) or Start key-click (Windows) the icon. When the limiter is disabled, the icon is black.

To re-enable the limiter:

- Click the icon. When the limiter is enabled, the icon is white.

To bypass the limiter:

- Click the icon a second time. When the limiter is bypassed, the icon is gray.

If you are using the Compressor/Limiter plug-in, which allows you to use either the compressor or the limiter (but not both simultaneously), you must disable one module by Control-clicking (Mac) or Start-clicking (Windows) the icon before you can enable the other.

Limit LED

When lit, the Limit LED indicates that limiting is being applied. When unlit, limiting is not being applied.



Limit LED

Threshold

This sets the threshold level. Signals that exceed this level will be limited. Signals that are below it will be unaffected. A setting of 0 dB is equivalent to no limiting. The range of this control is from -24 dB to 0 dB.



Threshold

Using the Side-Chain Input in D3

The *side-chain* is the split-off signal used by a plug-in's detector to trigger dynamics processing. D3 lets you switch between internal and external side-chain processing.

With external side-chain processing, a plug-in's detector is triggered by an external signal (such as a separate reference track or audio source) known as the *key input*.

A typical use for this feature is to use a kick drum track to gate and tighten up a bass track, or a rhythm guitar track to gate another instrument.

External Key

External Key toggles external side-chain processing on or off. When this button is enabled, the plug-in uses the amplitude of an external signal (the key input) to trigger compression or limiting. When this button is disabled, the plug-in uses the amplitude of the input signal to trigger dynamics processing.



External Key

Key Listen

Key Listen enables and disables auditioning of the key input controlling the external side-chain. This is useful for fine-tuning the compressor's settings to the key input.



Key Listen

Using a Key Input for External Side-Chain Processing

To use a key input to trigger dynamics processing:

- 1 Click the Key Input selector and select the input or bus carrying the audio from the reference track or external audio source.



Selecting a key input

- 2 Click External Key to activate external side-chain processing.
- 3 To listen to the key input that will be used to control side-chain processing, click Key Listen to enable it.
- 4 Begin playback. The plug-in uses the input or bus that you chose as an external key input to trigger its effect.
- 5 Adjust the plug-in Threshold control to fine-tune external key input triggering.

Chapter 15: Impact

Impact is available in DSP, Native, and AudioSuite formats. Impact plug-in provides critical control over the dynamic range of audio signals, with the look and sound of a mixing console's stereo-bus compressor.

Impact supports 44.1 kHz, 48 kHz, 88.2 kHz, 96 kHz, 176.4 kHz and 192 kHz sample rates.

Impact supports mono, stereo, and greater-than-stereo multichannel formats up to 7.1.

! *Greater-than-stereo formats are only available with Pro Tools HD.*



Impact

Impact Controls

Impact Ratio Control

Ratio sets the compression ratio. If the ratio is set to 2:1 for example, it will compress changes in signals above the threshold by one half. This control provides four fixed compression ratios, 2:1, 4:1, 10:1, and 20:1. Selecting 2:1 applies very light compression; selecting 20:1 applies heavy compression, bordering on limiting.

Impact Attack Control

Attack sets the compressor attack time. To use compression most effectively, the attack time should be set so that signals exceed the threshold level long enough to cause an increase in the average level. This helps ensure that gain reduction does not decrease the overall volume. The range of this control is from 0.1 ms to 30.0 ms.

Impact Threshold Control

Threshold sets the decibel level that a signal must exceed for Impact to begin applying compression. Signals that exceed the Threshold will be compressed by the amount of gain reduction set with the Ratio control. Signals that are below the Threshold will be unaffected. The range of the Threshold control is from -70 dB to -0 dB. A setting of -0 dB is equivalent to no compression.

Impact Release Control

Release controls the length of time it takes for the compressor to be fully deactivated after the input signal drops below the threshold level. In general, this setting should be longer than the attack time and long enough that if signal levels repeatedly rise above the threshold, they cause gain reduction only once. If the release time is too long, a loud segment of audio material could cause gain reduction to persist through a low-volume segment (if one follows). Setting this control to its maximum value, Auto, selects a release time that is program dependent, based on the audio being processed. The range of this control is from 20 milliseconds to 2.5 seconds.

Impact Make-up Control

Make-Up adjusts the overall output gain. Because large amounts of compression can restrict dynamic range, the Make-Up control is useful for compensating for heavily compressed signals and making up the resulting difference in level. When Impact is used on stereo or multichannel tracks, the Make-Up control determines master output levels for all channels. The range of this control is from 0 dB of attenuation to +40 dB of gain.

 *Applying large amounts of Make-Up gain will boost the level of any noise or hiss present in audio material, making it more audible.*

Impact Ext Control (Side-Chain)

External On/Off enables and disables side-chain processing. With side-chain processing you can trigger compression from a separate reference track or external audio source. The source used for triggering side-chain processing is referred to as the *Key Input*.

 *See “Using the Impact Compressor” on page 87 for instructions on setting up and using a key input.*

Impact Listen On/Off Control

Key Listen On/Off enables and disables auditioning of the Key Input (the reference track or external audio source used for triggering side-chain processing). This is useful for fine-tuning Impact’s compression settings to the Key Input.

Impact Gain Reduction Meter

The Gain Reduction meter is an analog-style meter that indicates the amount of gain reduction in dB. The range of this meter is from 0 dB to 40 dB. The gain reduction meter displays the amount of gain reduction linearly from 0–20 dB, and non-linearly from 20–40 dB.

Impact Meters

The Input/Output meters indicate input and output signal levels in dB. When Impact is used in mono or stereo, both input and output meters are displayed. When Impact is used in a multichannel format, only output meters are displayed by default. You can toggle the meter display to show only input meters by clicking the blue-green rectangle at the lower right of the meter display.

A red clip indicator appears at the top of each meter. Clicking a clip indicator clears it. Alt-clicking (Windows) or Option-clicking (Mac) clears the clip indicators on all channels.

Using the Impact Compressor

Compressors reduce the dynamic range of audio signals that exceed a user-selectable threshold by a specific amount. This is accomplished by reducing output levels as input levels increase above the threshold.

The amount of output level reduction that Impact applies as input levels increase is referred to as the *compression ratio*. This control is adjustable in discrete increments. If you set the compression ratio to 2:1, for example, for each 2 dB that the signal exceeds the threshold, the output level will be reduced to 1 dB above the threshold. With a compression ratio of 4:1, an 8 dB increase in input will produce only a 2 dB increase in output.

Side-Chain Processing

Compressors generally use the detected amplitude of their input signal as a control source. However, you can also use other signals, such as a separate reference track or an external audio signal as a control source. This is known as *side-chain* processing.

Side-chain processing lets you control Impact compression using an independent audio signal. In this way you can compress the audio of one track using the dynamics of a different audio track.

The reference track or external audio source used for triggering side-chain processing is referred to as the *Key Input*.

Using the Impact Side-Chain Input

Impact provides side-chain processing capabilities. Compressors typically use the detected amplitude of their input signal to cause gain reduction. This split-off signal is called the *side-chain*. However, an external signal (referred to as the *Key Input*) can be used to trigger compression.

A typical use for side-chain processing is to control the dynamics of one audio signal using the dynamics of another signal (referred to as the *Key Input*). For example, you could use a lead vocal track to trigger compression of a background vocal track so that their dynamics match.

To use a Key Input signal for side-chain processing:

- 1 Click the Send button and select a bus path for the audio track or Auxiliary Input you want to use as the side-chain signal.
- 2 From Impact's Key Input menu, select the input or bus path carrying the audio you want to use as the side-chain signal to trigger Impact compression. The Key Input source must be mono-
phonic.
- 3 To activate external side-chain processing, click Ext.
- 4 Begin playback. Impact uses the input or bus that you selected as a Key Input to trigger its effect.
- 5 If you want to hear the audio source you have selected as the side-chain input, click Listen. (To stop listening to the side-chain input, click Listen again).



Remember to disable Listen to resume normal plug-in monitoring.

- 6 Adjust Impact's Threshold control to fine-tune Key Input triggering.

Chapter 16: JOEMEEK SC2 Compressor

The JOEMEEK SC2 Compressor is a dynamics processing plug-in that is available in DSP, Native, and AudioSuite formats.

SC2 supports 44.1 kHz, 48 kHz, 88.2 kHz, 96 kHz, 176.4 kHz and 192 kHz sample rates.

SC2 operates as a mono, multi-mono, or stereo plug-in.



JOEMEEK SC2 Compressor

Legendary producer Joe Meek used to say, “If it sounds right, it is right.” Nowhere is this more apparent than in Joe Meek’s masterful use of non-linear, sometimes severe compression in his productions. In use by top producers the world over, JOEMEEK compression is the secret weapon that gives your sound the character and excitement it deserves!

The JOEMEEK Compressor is designed purely as an effects compressor. Its purpose is to change the way the ear perceives sound; its action changes the clarity, balance, and even rhythmic feel of music.

JOEMEEK Compressor Controls

The SC2 Compressor provides the following controls:

Input Gain Input Gain adjusts the input level to the compressor.

Compression The Compression control affects the gain to the side-chain of the compressor. Use it along with Slope to adjust the amount of compression.

Output Gain Output Gain provides makeup gain after compression.

Slope Slope is similar to the compression ratio controls found on other compressors. However, on the JOEMEEK, the actual ratio varies based on program material so the term Slope is used instead. In practice, 1 is very gentle compression and 2 or 3 are typically right for voice and submixes. The higher numbers are better for instruments and extreme sounds. (At the suggestion of the original designers, the 5 setting found on the later-model JOEMEEK SC2.2 were added. Use 5 to create severe pumping effects.)

Attack Attack sets the time that the compressor takes to act. Slower attacks are typically used when the sound of the compression needs to be less obvious.

Release Release sets the time during which signal returns to normal after compression. With longer release times, the compression is less noticeable.

JOEMEEK Compressor Tips and Tricks

Not Perfect, Just Right

Standard engineering practice says that a compressor should work logarithmically. For a certain increase of volume, the output volume should rise proportionally less, with a result that the more you put in, the more it's pushed down.

The JOEMEEK compressor doesn't work this way. As volume increases at the input, a point is reached where the compressor starts to work and the gain through the amplifier is reduced. If the input level keeps rising, gradually the gain reduction becomes less effective and the amplifier goes back to being a linear amplifier except with the volume turned down.

This is by design, and is based on an understanding of how the human ear behaves! The result is that the listener is fooled into thinking that the JOEMEEK compressed sound is louder than it really is—but without the strange psychoacoustic effect of “deadness” that other compressors suffer from.

Overshoot

At fast Attack settings, it is possible to make the JOEMEEK “overshoot” on percussive program material. This means that the compression electronics are driven hard before the light cells respond to the increased level. The cells catch up and overcompress momentarily giving a tiny dip immediately following the start of the note.

To hear it, use a drum track, set Slope to 5, and Attack and Release to Fast. Used sparingly, this effect can contribute to musical drive in your tracks.

Attack and Release Times

It may be difficult to understand the interactions between the Attack and Release controls, because the JOEMEEK Compressor behaves very differently than typical compressors. Experimentation is the best option, but an explanation may help you understand what's going on.

The JOEMEEK Compressor uses a compound release circuit that reacts quickly to short bursts of volume, and less quickly to sustained volume. While the unit was being prototyped and designed, the values and ranges of these timings were chosen by experimentation using wide ranges of program material.

Because of these intentional effects produced by the compressor, the JOEMEEK makes a perfect tool for general enhancement of tracks to “brighten,” “tighten,” “clarify,” and catch the attention of the listener, functions that are difficult or impossible to achieve with conventional compressor designs.

Chapter 17: Maxim

Maxim is a unique and powerful peak-limiting and sound maximizing plug-in that is available in DSP, Native, and AudioSuite formats. Maxim is ideal for critical mastering applications, as well as standard peak-limiting tasks.

Maxim offers several critical advantages over traditional hardware-based limiters. Maxim takes full advantage of the random-access nature of disk-based recording to anticipate peaks in audio material and preserve their attack transients when performing reduction. This makes Maxim more transparent than conventional limiters, since it preserves the character of the original audio signal without clipping peaks or introducing distortion.

Maxim supports 44.1 kHz, 48 kHz, 88.2 kHz, 96 kHz, 176.4 kHz and 192 kHz sample rates.

Maxim operates as a mono, multi-mono, or stereo plug-in.

Maxim features include:

- “Perfect attack-limiting” and look-ahead analysis accurately preserve transient attacks and the character of original program material
- A full-color histogram plots input dB history during playback and provides visual feedback for setting threshold level
- A user-adjustable ceiling lets material be level-optimized for recording
- Dither for noise shaping during final mixdown
- Online Help provides descriptions of each control, shown by holding the pointer over any of the elements in Maxim’s display.



Maxim

About Peak Limiting

Peak limiting is an important element of audio production. It is the process of preventing signal peaks in audio material from clipping by limiting their dynamic range to an absolute, user-selectable ceiling and not letting them exceed this ceiling.

Limiters let you select a threshold in decibels. If an audio signal peak exceeds this threshold, gain reduction is applied, and the audio is attenuated by a user-selectable amount.

Limiting has two main uses in the audio production cycle:

- Adjusting the dynamic range of an entire final mixdown for mastering purposes
- Adjusting the dynamic range of individual instruments for creative purposes

Limiting a Mix

The purpose of applying limiting during final mixdown is to flatten any large peaks remaining in the audio material to have a higher average signal level in the final mix. By flattening peaks that would otherwise clip, it is possible to increase the overall level of the rest of the mix. This results in higher average audio levels, potentially better signal to noise ratio, and a smoother mix.

Limiting Individual Instruments

The primary purpose of applying limiting to individual instruments is to alter their dynamic range in subtle or not-so-subtle ways. A common application of this type of limiting is to modify the character of drums. Many engineers do this by applying heavy limiting to flatten the snap of the attack portion of a drum hit. By adjusting the release time of the limiter it is possible to bring up room tone contained in the decay portion of the drum sound.

In some cases, this type of limiting can actually change a drum's character from a very dry sound to a relatively wet sound if there is enough room tone present. This method is not without its drawbacks, however, since it can also bring noise levels up in the source audio if present.

How Maxim Differs From Conventional Limiters

Maxim is superior to conventional limiters in several ways. Unlike traditional limiters, Maxim has the ability to anticipate signal peaks and respond instantaneously with a true zero attack time.

Maxim does this by buffering audio with a 1024-sample delay while looking ahead and analyzing audio material on disk before applying limiting. Maxim can then instantly apply limiting before a peak builds up. The result is extremely transparent limiting that faithfully preserves the attack transients and retains the overall character of the original unprocessed signal.

In addition, Maxim provides a histogram, that displays the distribution of waveform peaks in the audio signal. This provides a convenient visual reference for comparing the density of waveform peaks at different decibel levels and choosing how much limiting to apply to the material.

⚠ *Maxim introduces a delay that is proportional to the session sample rate. To preserve phase synchronicity between multiple audio sources when Maxim is only applied to one of these sources, use Delay Compensation or the Time Adjuster plug-in.*

Maxim Controls and Meters

Maxim Input Level Meter

This meter displays the amplitude of input signals prior to limiting. Unlike conventional meters, Maxim's Input meter displays the top 24 dB of dynamic range of audio signals, which is where limiting is typically performed. This provides you with much greater metering resolution within this range so that you can work with greater precision.

Maxim Histogram

The Histogram displays the distribution of waveform peaks in the audio signal. This graph is based on audio playback. If you select and play a short loop, the histogram is based on that data. If you select and play a longer section, the Histogram is based on that. Maxim holds peak data until you click the Histogram to clear it.

The Histogram provides a visual reference for comparing the density of waveform peaks at different decibel levels. You can then base limiting decisions on this data.

The X axis of the Histogram shows the number of waveform peaks occurring at specific dB levels. The Y axis shows the specific dB level at which these peaks occur. The more waveform peaks that occur at a specific dB level, the longer the X-axis line. If there appears to be a pronounced spike at a certain dB level (4 dB for example), it means that there are a relatively large number of waveform peaks occurring at that level. You can then use this information to decide how much limiting to apply to the signal.

By dragging the Threshold slider downwards, you can visually adjust the level at which limiting will occur. Maxim displays the affected range in orange.

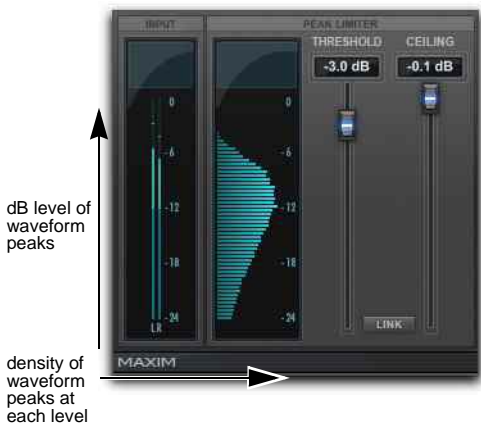

Histogram

Maxim Threshold Slider

This slider sets the threshold level for limiting. Signals that exceed this level will be limited. Signals below it will be unaffected. Limited signal peaks are attenuated to match the threshold level, so the value that you set here will determine the amount of reduction applied.

Maxim Output Meter

This meter displays the amplitude of the output signal. The value that appears here represents the processed signal after the threshold, ceiling, and mixing settings have been applied.

Maxim Ceiling Slider

This slider determines the maximum output level. After limiting is performed you can use this slider to adjust the final output gain. The value that you set here will be the absolute ceiling level for limited peaks.

Maxim Attenuation Meter

This meter displays the amount of gain reduction being applied over the course of playback, with the maximum peak displayed in the numeric readout at the bottom of the meter. For example, if the numerical display at the bottom of the Attenuation meter displays a value of 4 dB, it means that 4 dB of limiting has occurred. Since this is a peak-hold readout, you can temporarily walk away from a session during playback and still know the maximum gain reduction value when you come back. To clear the numeric readout, click it with the mouse.

Maxim Release Knob

This knob sets how long it takes for Maxim to ease off of its attenuation after the input signal drops below the threshold level. Because Maxim has an attack time of zero milliseconds, the release control has a very noticeable effect on the character of limiting. In general, if you are using heavy limiting, you should use proportionally longer release times in order to avoid pumping that may occur when Maxim is forced to jump back and forth between limited and unlimited signal levels. Lengthening the release time has the effect of smoothing out these changes in level by introducing a lag in the ramp-up or ramp-down time of attenuation. Use short release times on material with peaks that are relatively few in number and that do not occur in close proximity to each other. The Release control has a default value of 1 millisecond.

Maxim Mix Slider

This slider sets the ratio of dry signal to limited signal. In general, if you are applying Maxim to a main output mix, you will probably want to set this control to 100% wet. If you are applying heavy limiting to an individual track or element in a mix to modify its character, this control is particularly useful since it lets you control precisely the amount of the processed effect mixed with the original signal.

Maxim Link Button

When depressed, this button (located between the Threshold and Ceiling numeric readouts) links the Threshold and Ceiling controls. These two sliders will then move proportionally together. As you lower the Threshold control, the Ceiling control is lowered as well. When these controls are linked you can conveniently compare the effect of limiting at unity gain by clicking the Bypass button.

Maxim Dither Button

When selected, this applies dither. Dither is a form of randomized noise used to minimize quantization artifacts in digital audio systems. Quantization artifacts are most audible when the audio signal is near the low end of its dynamic range, such as during a quiet passage or fade-out.

Applying dither helps reduce quantization noise that can occur when you are mixing from a 24-bit source to a 16-bit destination, such as CD-R or DAT. If you are using Maxim on a Master Fader during mixdown, Maxim's built-in dither function saves you the trouble and DSP resources of having to use a separate Dither plug-in.

If Dither is disabled, the Noise Shaping and Bit Resolution controls will have no effect.

Maxim Noise Shaping Control

When selected, this applies noise-shaped dither. Noise shaping biases the dither noise to less audible high frequencies so that it is not as readily perceived by the ear. Dither must be enabled in order to use Noise Shaping.

Maxim Bit Resolution Button

These buttons select dither bit resolution. In general, set this control to the maximum bit resolution of your destination media.

- ◆ 16-bit is recommended for output to digital devices such as DAT recorders and CD recorders since they have a maximum resolution of 16 bits.
- ◆ 18-bit is recommended for output to digital devices that have a maximum resolution of 18 bits.
- ◆ 20-bit is recommended for output to digital devices that support a full 20-bit recording data path. It is recommended for use with digital effects devices that support 20-bit input and output, since it provides for a lower noise floor and greater dynamic range when mixing 20-bit signals directly into Pro Tools.

Using Maxim

Following are suggestions for using Maxim most effectively.

To use Maxim:

- 1 Insert Maxim on a track.
- 2 Select the portion of the track containing the most prominent audio peaks.
- 3 Loop playback and look at the data displayed by the Histogram and Attenuator meter.
- 4 Select the Link button to link the Threshold and Ceiling controls. You can then adjust these controls together proportionally and, using the Bypass button, compare the audio with and without limiting.
- 5 Adjust the Threshold downwards until you hear and see limiting occur, then bring the Threshold back up slightly until you have roughly the amount of limiting you want.
- 6 Periodically click and clear the Attenuation meter to check attenuation. In general, applying 2 dB to 4 dB of attenuation to occasional peaks in pop-oriented material is appropriate.
- 7 Use the Bypass button to compare the processed and unprocessed sound and to check if the results are acceptable.
- 8 Avoid pumping effects with heavier limiting by setting the Release control to longer values.
- 9 When you get the effect you want, deselect the Link button and raise the output level with the Ceiling slider to maximize signal levels without clipping.

In general, a value of -0.5 dB or so is a good maximum ceiling. Don't set the ceiling to zero, since the digital-to-analog converters on some DATs and CD players will clip at or slightly below zero.



If you are using Maxim on an output mix that will be faded out, enable the dithering options you want to improve the signal performance of the material as it fades to lower amplitudes.

Maxim and Mastering

If you intend to deliver audio material as a 32-bit floating point or 24-bit audio file on disk for professional mastering, be aware that many mastering engineers prefer material delivered without dither or level optimization.

Mastering engineers typically want to receive audio material as undisturbed as possible in order to have leeway to adjust the level of the material relative to other material on a CD. In such cases, it is advisable to apply only the limiting that you find creatively appropriate—adding a little punch to certain instruments in the mix, for example.

However, if you intend to produce 16-bit output from a source with a higher bit depth, use appropriate limiting and add dither. Doing so will optimize the dynamic range and preserve the activity of the lower, or least-significant bits in the audio signal, smoothly dithering them into the 16-bit output.

Chapter 18: Pro Compressor

Avid Pro Compressor is available in DSP, Native, and AudioSuite formats. Pro Compressor provides dynamic compression processing. The Avid Pro Compressor processing algorithms are based on the award-winning Euphonix System 5 console channel strip effects.

Pro Compressor supports 44.1 kHz, 48 kHz, 88.2 kHz, 96 kHz, 176.4 kHz and 192 kHz sample rates.

Pro Compressor supports mono, stereo, and greater-than-stereo multichannel formats up to 7.1.

! *Greater-than-stereo formats are only available with Pro Tools HD.*



Pro Compressor

In addition to standard knob and fader controls, Pro Compressor also provides a dynamics graph to track the gain transfer curve for compression, as well as a frequency graph for side-chain filtering. Additionally, the dynamics graph can be used to graphically edit the Threshold, Ratio, Knee, and Depth settings.

Pro Compressor Metering

Pro Compressor provides combined meters that show both sample peak metering and averaged metering. Pro Compressor uses sample peak meters over average metering for Input and Output signals. Attenuation metering uses sample peak metering only.

The Peak Hold value is displayed numerically at the top of the meter and the Peak Hold indicator appears as a thin orange line in the meter. This provides highly accurate visual metering correlation with the audio signal. Pro Compressor also displays averaging metering with an integration time of approximately 400 ms.

Input and Output meters use the following color coding:

Dark Blue Indicates nominal levels from -90 to -20 dB.

Light Blue Indicates pre-clipping levels, from -20 dB to 0 dB.

Yellow Indicates full scale levels from 0 dB to +6 dB.

Attenuation meters show yellow for the entire dynamic range displayed.

Peak Indicators

The Input and Output meters provide graphical representation of transient peaks, as well as graphical and numerical display of the last, greatest registered peak (Peak Hold). The Attenuation meter provides similar graphical and numeric representations for the amount of compression applied to the input signal.

The numerical display for the Peak value turns orange when the signal exceeds 0 dB on the meters. You can click the numerical display to reset the displayed value.

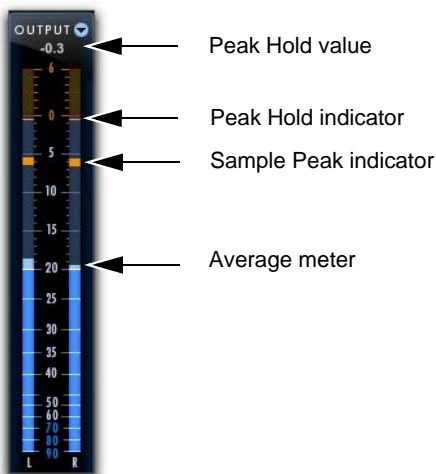

Peak indicators in the Output meters

Pro Compressor Input Section

The Input section provides input metering and controls for adjusting the level of the input signal.

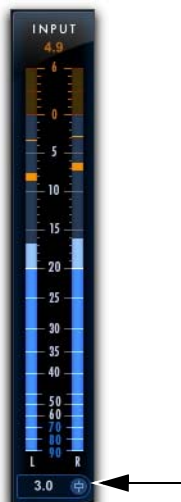

Input section with Meters and Input Level control

Input Level

The Input Level control sets the input gain of the plug-in before processing, letting you boost or attenuate gain at the plug-in input stage.

To adjust the level of the input signal, do one of the following:

- Click in the Input Level field to type a value (–36.0 dB to +36.0 dB).
- Click the Input Level control and drag up or down to adjust the Input Level setting.

Input Meters

The Input meters show peak signal levels before processing.

Pro Compressor Output Section

The Output section provides output metering and controls for adjusting the level of the output signal. The Output meters can also be toggled to show post-processing gain attenuation meters.

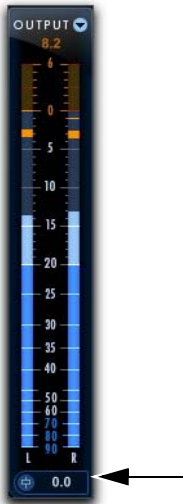

Output section with Meters and Output Level control

Output Level

The Output Level control sets the output level after processing, letting you make up gain or prevent clipping on the channel where the Pro Compression plug-in is being used.

To adjust the output level, do one of the following:

- Click in the Output Level field and type a value (–INF dB to +12 dB).
- Click the Output Level control and drag up or down to adjust the Output Level setting.

Output Meters

The Output meters show peak signal levels after processing.

Attenuation Meters

The Output meter can be switched to show Attenuation metering for the processed signal from 0 dB to –36 dB.

To toggle between the Attenuation and Output meters:

- Click the Output/Attenuation toggle in the top right-hand corner of the Output section.

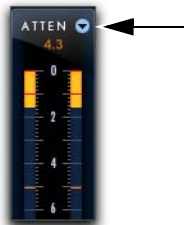

Output/Attenuation toggle (Attenuation meters shown)

Pro Compressor Dynamics Graph

The Dynamics Graph display shows a curve that represents the level of the input signal (on the horizontal x-axis) and the amount of gain reduction applied (on the vertical y-axis). The display shows a vertical line representing the Threshold setting for the Compressor.

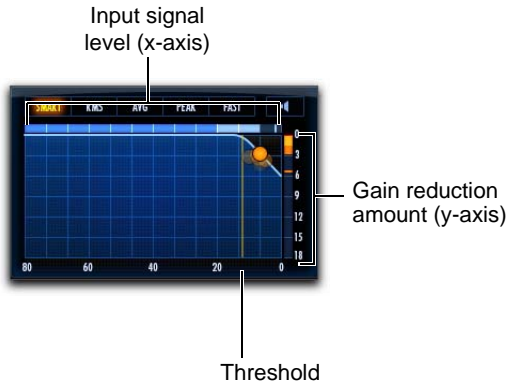

Dynamics graph display

The Dynamics Graph display also features an animated red ball in the gain transfer curve display. This ball shows the amount of input gain (x-axis) and gain reduction (y-axis) being applied to the incoming signal at any given moment. To indicate overshoots (when an incoming signal peak is too fast for the current compression setting), the ball temporarily leaves the gain transfer curve.

Use this graph as a visual guideline to see how much dynamics processing you are applying to the incoming audio signal.

Using the Dynamics Graph to Adjust Controls

You can drag in the Dynamics Graph display to adjust the corresponding Compressor controls. The cursor updates to show which control is being adjusted:

- Threshold
- Ratio
- Knee
- Depth

To adjust the Threshold setting using the Dynamics graph:

- Position the cursor over the vertical Threshold line in the graph and drag left or right to make the adjustment.



Cursor indicates Threshold adjustment

To adjust the Ratio setting using the Dynamics graph:

- Position the cursor over the ratio curve in the graph and drag up or down (or left or right) to make the adjustment.



Cursor indicates Ratio adjustment

To adjust the Knee setting using the Dynamics graph:

- Position the cursor over the “knee” of the curve in the graph and drag up or down (or left or right) to make the adjustment.

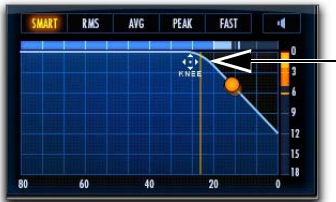

Cursor indicates Knee adjustment

To adjust the Depth setting using the Dynamics graph:

- Position the cursor over the horizontal Depth line in the graph and drag up or down (or left or right) to make the adjustment.



Cursor indicates Depth adjustment

Detection Modes

Pro Compressor provides several different detection options for determining how the compressor responds to the input signal.

To change the detection mode for the compressor:

- Click a detection mode from the options available above the Dynamics graph.



Detection mode options (Smart mode selected)

Detection options include the following:

Smart Select the Smart option for tracks with diverse input signals, or if you are simply not sure what detector works best with the given audio material. The Smart option analyzes the incoming signal and interpolates between the different detection modes as needed. This lets you apply a lot of compression without distortion or pumping.

RMS Select the RMS option to apply processing according to the detected RMS (Root Mean Square) amplitude of the input signal. The RMS option is similar to the Average option, but with a faster release time.

Average Select the Average option to apply processing according to the detected average amplitude of the input signal.

Peak Select the Peak option to apply processing according to the detected peak amplitude of the input signal.

Fast Select the Fast option for tracks with high and short transient signals, such as a snare drum track. The Fast option is similar to the Peak option, but with faster attack and release times. However, be careful when using the Fast option as it distorts earlier than the other options. Be sure to configure the other compressor settings with this in mind.

Attenuation Listen Mode

Attenuation Listen mode lets you isolate the gain reduction part of the processed audio signal. This can help you hear what parts of the input signal are triggering compression, which, in turn, can help you better understand the characteristics of the compressor with the current settings.

To enable (or disable) Attenuation Listen mode:

- Click the Attenuation Listen button (the speaker icon at the top right of the dynamics graph) so that it is highlighted. The button flashes while Attenuation Listen mode is enabled. To disable it, click the button again so that it is not highlighted.



Attenuation Listen mode enabled

Pro Compressor Controls

Threshold

The Threshold control sets the level that an input signal must exceed to trigger compression. A signal will be compressed if its level exceeds this setting. If the signal level falls below this value, no compression will occur.

Ratio

The Ratio control sets the compression ratio—the amount of compression applied as the input signal exceeds the threshold. For example, a 2:1 compression ratio means an input level that is 2 dB above the threshold will be attenuated, resulting in an output level that is 1 dB over the threshold. The compression ratio ranges from 1.0:1 to 20.0:1.

Once the Ratio control hits 21.0:1, it displays LMTR. The LMTR setting marks the highest “normal” compression mode before the onset of negative compression values (from –20.0:1 to 0:1).

At the LMTR setting, for every decibel that the incoming signal goes over the set Threshold, 1 dB of gain reduction is applied.



Compressor Ratio set to LMTR

Once the Ratio control passes the LMTR setting, it provides negative ratio settings from $-20.0:1$ to $0:1$.



Compressor Ratio set to a negative value

With these settings, for every decibel that the incoming signal goes over the set Threshold, more than 1 dB of gain reduction is applied according to the negative Ratio setting. For example, at the setting of $-1.0:1$, for each decibel over the set threshold, 2 dB of gain reduction is applied. Consequently, the output signal is both compressed and made softer. You can use this as a creative effect, or as a kind of ducking effect when used with an external key input.

Knee

The Knee control sets the rate at which the compressor reaches full compression once the threshold has been exceeded.

As you increase this control, it goes from applying “hard-knee” compression to “soft-knee” compression:

- With hard-knee compression, compression begins when the input signal exceeds the threshold. This can sound abrupt and is ideal for limiting.
- With soft-knee compression, gentle compression begins and increases gradually as the input signal approaches the threshold, and reaches full compression after exceeding the threshold. This creates smoother compression.

Attack

The Attack control sets the attack time, or the rate at which gain is reduced after the input signal level crosses the threshold.

The smaller the value, the faster the attack. The faster the attack, the more rapidly the compressor applies attenuation to the signal. If you use fast attack times, you should generally use a proportionally longer release time, particularly with material that contains many peaks in close proximity.



The actual compression attack time is also dependent on the selected Detection mode. Each mode has its own attack and release times that are calculated in advance of compression processing. If a slower Detection mode is selected (such as AVG), the fastest possible actual attack time for compression can only be about 20 ms. The selected Detection mode similarly affects the compressor release time.

Release

The Release control sets the length of time it takes for compression to be fully deactivated after the input signal drops below the threshold.

Release times should be set long enough that if signal levels repeatedly rise above the threshold, the gain reduction “recovers” smoothly. If the release time is too short, the gain can rapidly fluctuate as the compressor repeatedly tries to recover from the gain reduction. If the release time is too long, a loud section of the audio material could cause gain reduction that continues through soft sections of program material without recovering.

Depth

The Depth control sets the maximum amount of gain reduction applied regardless of the input signal. For example, if Ratio is set to LMTR (between 20.0:1 and –20.0:1) and Depth is set to Off, up to 20 dB of gain reduction is applied to the incoming signal (at 0 dB). If you set Depth to –10 dB, no more than 10 dB of gain reduction is applied to the incoming signal.

Dry Mix

The Dry Mix control sets the balance between the compressed signal (wet) and the original signal (dry). The Dry Mix setting determines how much of the original signal is sent to the output rather than the processed signal. For example, at 30%, the output will be 30% dry and 70% wet. Turn the Dry Mix knob counterclockwise to 0% to pass only the processed signal (100% wet). Turn the Dry Mix knob clockwise to 100% to pass only the input signal (100% dry).

Makeup

The Makeup control lets you boost overall output gain to compensate for heavily compressed or limited signals.

Pro Compressor Side-Chain Processing

Dynamics processors typically use the detected amplitude of their input signal to trigger gain reduction. This is known as a *side-chain* signal. Pro Compressor provides filters for side-chain processing and supports external key side-chain capabilities.

With external key side-chain processing, you can trigger dynamics processing using an external signal (such as a separate reference track or audio source) instead of the input signal. This external source is known as the *key input*.

With side-chain filters, you can make dynamics processing more or less sensitive to certain frequencies. For example, you might configure the side-chain so that certain lower frequencies on a drum track trigger dynamics processing.



Side-Chain section

Source

The Source selector lets you set the source for side-chain processing: Int-Stereo Pairs, Ext-All (w/LFE), Int All (no LFE), or Int-Front/Rear.

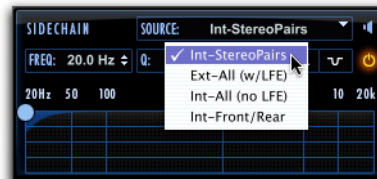

Selecting the Source for side-chain processing

Internal Source—Stereo Pairs

When Int-StereoPairs is selected, the plug-in uses the amplitude of the input signal to trigger dynamics processing based on stereo input. With greater-than-stereo multichannel processing, the input signal for each stereo pair affects only those same channels, and likewise mono channels are affected only by their own input signal. For example, with an LCR multichannel format, the processing for the Center channel is only triggered when the Center

channel input signal reaches the threshold. However, when the input signal reaches the threshold on the Left or the Right channel, processing is triggered for both the Left and the Right channel.

External All (with LFE)

When Ext-All (w/LFE) is selected, the plug-in uses the amplitude of a separate reference track or external audio source to trigger dynamics processing. The reference track used is selected using the Plug-In Key Input selector in the Plug-In window header. With greater-than-stereo multichannel processing, the key signal triggers dynamics processing for all processed audio channels equally.



Selecting the Source for side-chain processing

Internal-All (No LFE)

When Int-All (no LFE) is selected, dynamics processing is applied equally to all channels when the input signal reaches the threshold on any input channel, except for the LFE channel (if present). The LFE channel is processed independently based on its own input signal.

Internal Front/Rear

For LCRS or greater channel formats, when Int Front/Rear is selected, dynamics processing is applied based on front channel inputs (LCR) and surround channel inputs (S) independently. For .1 formats, the LFE channel is processed independently based on its own input signal.

Side-Chain Listen Mode

Listen mode lets you hear the input signal for the side-chain to the compressor. This can be either the external key input or the internal side-chain (including the applied filter).

To enable (or disable) Listen mode on the side-chain:

- Click the Listen button in the top-right corner of the Side-Chain section so that it is highlighted. The icon flashes while Side-Chain Listen mode is enabled. To disable it, click the button again so that it is not highlighted.



Side-Chain Listen mode enabled

⚠ Attenuation Listen and Side-Chain Listen can be enabled simultaneously, in which case Attenuation Listen is audible but Side-Chain Listen is not.

Side-Chain Filter On/Off

You can use the side-chain input with or without filtering by enabling or disabling the Side-Chain Filter On/Off button.

To enable (or disable) filtering on the Side-Chain:

- Click the Side-Chain Filter On/Off button on the right side of the Side-Chain section so that it is highlighted. To disable it, click the button again so that it is not highlighted.



Side-Chain Filter enabled

Side-Chain Filter

The side-chain-filter applies only to the side-chain signal feeding the Pro Compressor detection algorithm. Compression is triggered only when the signal exceeds the Threshold setting at the frequencies passing through the side-chain filter.

 *Note that the side-chain filter does not apply filtering to the compressed signal. Compression is applied to all frequencies of the input signal when compression is triggered by the side-chain.*

Filter Frequency

The Freq control lets you set the center frequency for the selected Filter Type (from 20 Hz to 21.0 kHz).

Filter Q

When the Filter Type is set to Band Pass or Notch, the Q control is available. The Q control changes the width of the filter around the center frequency band. Higher Q values represent narrower bandwidths. Lower Q values represent wider bandwidths.

Filter Type

Four Filter Type options are available for side-chain processing:

Low Pass Select the Low Pass option to apply a low pass filter to the side-chain processing at the selected frequency.

High Pass Select the High Pass option to apply a high pass filter to the side-chain processing at the selected frequency.

Notch Select the Notch option to apply a notch filter to the side-chain processing at the selected frequency.

Band Pass Select the Band Pass option to apply a band pass filter to the side-chain processing at the selected frequency.

Side-Chain Processing Graph

The Side-Chain Processing Graph display shows the frequency curve for the selected Filter Type at the selected Filter Frequency.

Chapter 19: Pro Expander

Avid Pro Expander is available in DSP, Native, and AudioSuite formats. Pro Expander provides dynamic expansion and gating processing. The Avid Pro Expander processing algorithms are based on the award-winning Euphonix System 5 console channel strip effects.

Pro Expander supports 44.1 kHz, 48 kHz, 88.2 kHz, 96 kHz, 176.4 kHz and 192 kHz sample rates.

Pro Expander supports mono, stereo, and greater-than-stereo multichannel formats up to 7.1.

! *Greater-than-stereo formats are only available with Pro Tools HD.*



Pro Expander

In addition to standard knob and fader controls, Pro Expander also provides a dynamics graph to track the gain transfer curve for dynamic expansion and gating, as well as a frequency graph for side-chain filtering. Additionally, the dynamics graph can be used to graphically edit the Threshold, Ratio, Knee, and Depth settings.

Pro Expander Metering

Pro Expander provides combined meters that show both sample peak metering and averaged metering. Pro Expander uses sample peak meters over average metering for Input and Output signals. Attenuation metering uses sample peak metering only.

The Peak Hold value is displayed numerically at the top of the meter and the Peak Hold indicator appears as a thin orange line in the meter. This provides highly accurate visual metering correlation with the audio signal. Pro Expander also displays averaging metering with an integration time of approximately 400 ms.

Input and Output meters use the following color coding:

Dark Blue Indicates nominal levels from -90 dB to -20 dB.

Light Blue Indicates pre-clipping levels, from -20 dB to 0 dB.

Yellow Indicates full scale levels from 0 dB to +6 dB.

Attenuation meters show dark blue for the entire dynamic range displayed.

Peak Indicators

The Input and Output meters provide graphical representation of transient peaks, as well as graphical and numerical display of the last, greatest registered peak. The Attenuation meter provides similar graphical and numeric representations for the amount of compression.

The numerical display for the Peak value turns orange when the signal exceeds 0 dB on the meters. You can click the numerical display to reset the displayed value.

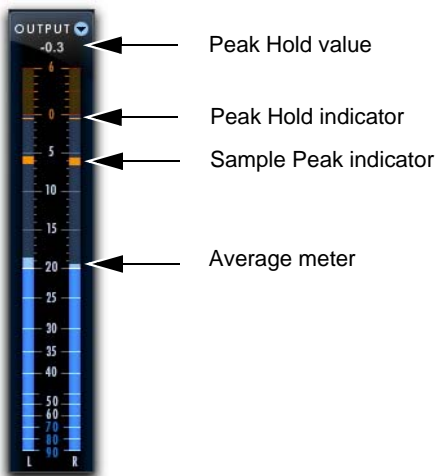

Peak indicators in the Output meters

Pro Expander Input Section

The Input section provides input metering and controls for adjusting the level of the input signal.



Input section with Meters and Input Level control

Input Level

The Input Level control sets the input gain of the plug-in before processing, letting you boost or attenuate gain at the plug-in input stage.

To adjust the level of the input signal, do one of the following:

- Click in the Input Level field and type a value (–36.0 dB to +36.0 dB).
- Click the Input Level control and drag up or down to adjust the Input Level setting.

Input Meters

The Input meters show peak signal levels before processing.

Pro Expander Output Section

The Output section provides output metering and controls for adjusting the level of the output signal. The Output meters can also be toggled to show post-processing gain attenuation meters.

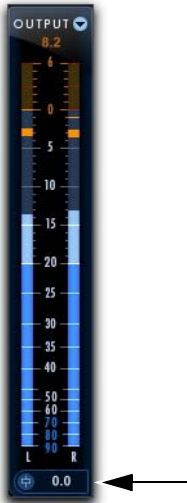

Output section with Meters and Output Level control

Output Level

The Output Level control sets the output level after processing, letting you boost or attenuate gain on the channel where the Pro Expander plug-in is being used.

To adjust the output level, do one of the following:

- Click in the Output Level field to type a value (–INF dB to +12 dB).
- Click the Output Volume control and drag up or down to adjust the Output Volume setting.

Output Meters

The Output meters show peak signal levels after processing.

Attenuation Meters

The Output meter can be switched to show Attenuation metering for the processed signal from 0 dB to –36 dB.

To toggle between the Attenuation and Output meters:

- Click the Output/Attenuation toggle in the top right-hand corner of the Output section.



Output/Attenuation toggle, Attenuation meters shown

Pro Expander Dynamics Graph

The Dynamics Graph display shows a curve that represents the level of the input signal (on the horizontal x-axis) and the amount of processing applied (on the vertical y-axis). The display shows a vertical line representing the Threshold setting for the Expander.

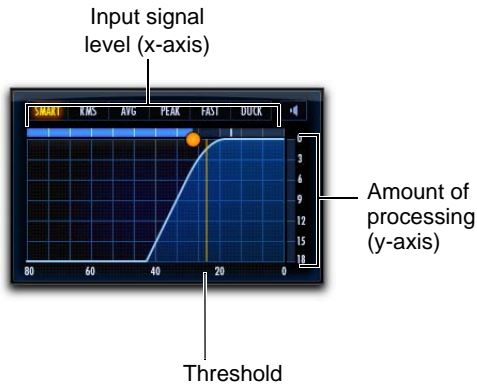

Dynamics graph display

The Dynamics Graph display also features an animated red ball in the gain transfer curve display. This ball shows the amount of input gain (x-axis) and gain reduction (y-axis) being applied to the incoming signal at any given moment. To indicate overshoots (when an incoming signal peak is too fast for the current compression setting), the ball temporarily leaves the gain transfer curve.

Use this graph as a visual guideline to see how much dynamics processing you are applying to the incoming audio signal.

Using the Dynamics Graph to Adjust Controls

You can drag in the Dynamics Graph display to adjust the corresponding Expander controls. The cursor updates to show which control is being adjusted:

- Threshold
- Ratio
- Knee
- Depth

To adjust the Threshold setting using the Dynamics graph:

- Position the cursor over the vertical Threshold line in the graph and drag left or right to make the adjustment.



Cursor indicates Threshold adjustment

To adjust the Ratio setting using the Dynamics graph:

- Position the cursor over the ratio curve in the graph and drag up or down (or left or right) to make the adjustment.



Cursor indicates Ratio adjustment

To adjust the Knee setting using the Dynamics graph:

- Position the cursor over the “knee” of the curve in the graph and drag up or down (or left or right) to make the adjustment.

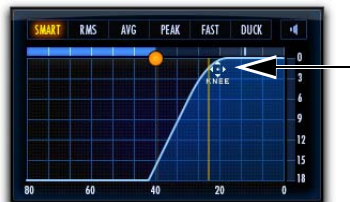

Cursor indicates Knee adjustment

To adjust the Depth setting using the Dynamics graph:

- Position the cursor over the horizontal Depth line in the graph and drag up or down (or left or right) to make the adjustment.



Cursor indicates Depth adjustment

Detection Modes

Pro Expander provides several different detection options for determining how the expander responds to the input signal.

To change the detection mode for the expander:

- Click a detection mode from the options available above the Dynamics graph.

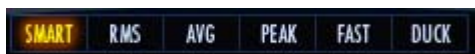

Detection mode options, Smart mode selected

Detection options include the following:

Smart Select the Smart option for tracks with diverse input signals, or if you are simply not sure what detector works best with the given audio material. The Smart option analyzes the incoming signal and switches between the different detection modes as needed.

RMS Select the RMS option to apply processing according to the detected RMS (Root Mean Square) amplitude of the input signal. The RMS option is similar to the Average option, but with a faster release time.

Average Select the Average option to apply processing according to the detected average amplitude of the input signal.

Peak Select the Peak option to apply processing according to the detected peak amplitude of the input signal.

Fast Select the Fast option for tracks with high and short transient signals, such as a snare drum track. The Fast option is similar to the Peak option, but with faster attack and release times. However, be careful when using the Fast option as it distorts earlier than the other options. Be sure to configure the other compressor settings with this in mind.

Duck Select the Duck option to use Pro Expander as a ducker. In order to use Pro Limiter as a ducker, set up an external key input side-chain bussed from another track. When the Duck option is enabled, the incoming signal is attenuated when the side-chain input crosses the Threshold setting. For the most predictable results, set Ratio to GATE. Use the Depth control to adjust the amount of ducking applied to the input signal. Dialog or voice-over is most commonly used as an external key input to duck (attenuate) the program material (typically music) on the track where Pro Expander is inserted.



As a general rule, when ducking program material with dialog or voice-over, set the Attack and Release controls in a range of 300 to 500 milliseconds.



When Duck is enabled, the Upward option is automatically disabled.

Attenuation Listen Mode

Attenuation Listen mode lets you isolate the processed part of the audio signal. This can help you hear what parts of the input signal are triggering expansion or gating, which, in turn, can help you better understand the characteristics of the current settings of the expander/gate.

To enable (or disable) Attenuation Listen mode:

- Click the Attenuation Listen button (the speaker icon at the top right of the dynamics graph) so that it is highlighted. The button flashes while Attenuation Listen mode is enabled. To disable it, click the button again so that it is not highlighted.

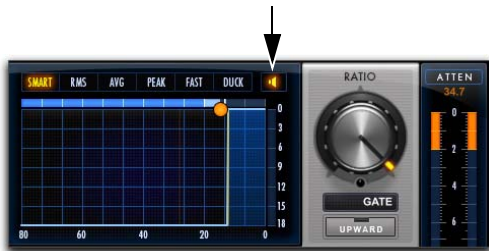

Attenuation Listen mode enabled

Pro Expander Controls

Threshold

The Threshold control sets the level below which an input signal must fall to trigger expansion or gating. Signals that fall below the threshold will be reduced in gain. Signals that are above it will be unaffected.

The Dynamics Graph display shows the threshold as a vertical line.

Ratio

The Ratio control sets the amount of expansion. For example, if this is set to 2:1, it will lower signals below the threshold by one half. At higher ratio levels, Pro Expander functions like a gate by cutting off signals that fall below the threshold. As you adjust the ratio control, refer to the Dynamics Graph display to see how the shape of the expansion curve changes.

Upward

The Upward button enables Upward Expansion mode. When Upward Expansion mode is enabled, Pro Expander amplifies signals above the Threshold. When it is disabled, the signal is attenuated when the signal falls below threshold.

To enable (or disable) Upward Expansion mode:

- Click the Upward button so that it is highlighted. To disable it, click the button again so that it is not highlighted.

Knee

The Knee control sets the rate at which the processor reaches full expansion or gating effect once the threshold has been exceeded.

Attack

The Attack control sets the attack time, or the rate at which gain is reduced after the input signal crosses the threshold. Use this along with the Ratio setting to control how soft Pro Expander's gain reduction curve is.

Release

The Release control sets how long it takes for the expansion to close or the gate to open after the input signal falls below the Threshold level and the Hold time has passed.

Depth

The Depth control sets the depth of the processing (expansion or gating) when closed. Setting the processing to higher Depth levels allows more audio that falls below the threshold to remain audible.

Hold

The Hold control specifies the duration (in seconds or milliseconds) during which Pro Expander stays in effect after the initial attack occurs. This can keep processing in effect for longer periods of time with a single crossing of the threshold. It can also be used to prevent gate chatter that may occur if varying input levels near the threshold cause the gate to close and open very rapidly.

Hysteresis

The Hysteresis control lets you adjust whether or not the gate rapidly opens and closes when the input signal fluctuates near the Threshold. This can help prevent undesirably rapid gating of the signal. This control is only available when Ratio is set to Gate.

Dry Mix

The Dry Mix control sets the balance between the processed signal (wet) and the original signal (dry). The Dry Mix setting determines how much of the original signal is sent to the output rather than the processed signal. For example, at 30%, the output will be 30% dry and 70% wet. Turn the Dry Mix knob counterclockwise to 0% to pass only the processed signal (100% wet). Turn the Dry Mix knob clockwise to 100% to pass only the input signal (100% dry).

Lookahead

The Lookahead control lets you add a certain amount of delay in milliseconds for analyzing incoming audio. All attack transients take a certain amount of time from the onset of the signal to the actual transient peak (especially those with lower frequencies, like a kick drum). Adjust the Lookahead time to ensure that processing with an Attack setting of 0 (or at least very short) can be accurate to the true attack time of transients in the signal.

Note that as soon as Lookahead is engaged, the full amount of delay time is added to the Pro Expander plug-in processing latency. When Lookahead is set to Off, no additional latency is incurred.



You can compensate for plug-in processing delay using Automatic Delay Compensation in Pro Tools. For more information, see the Pro Tools Reference Guide.

Pro Expander Side-Chain Processing

Dynamics processors typically use the detected amplitude of their input signal to trigger gain reduction. This is known as a *side-chain* signal. Pro Expander provides filters for side-chain processing and supports external key side-chain capabilities.

With external key side-chain processing, you can trigger dynamics processing using an external signal (such as a separate reference track or audio source) instead of the input signal. This external source is known as the *key input*.

With side-chain filters, you can make dynamics processing more or less sensitive to certain frequencies. For example, you might configure the side-chain so that certain lower frequencies on a drum track trigger dynamics processing.

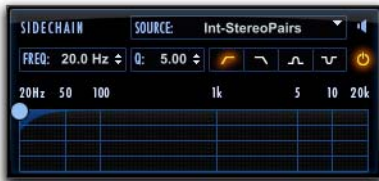

Side-Chain section

Source

The Source selector lets you set the source for side-chain processing: Int-Stereo Pairs, Ext-All (w/LFE), Int All (no LFE), or Int-Front/Rear.

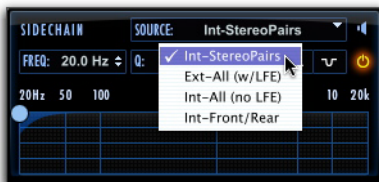

Selecting the Source for side-chain processing

Internal Source—Stereo Pairs

When Int-StereoPairs is selected, processing is triggered for *both* the Left and Right channel when the input signal reaches the threshold on either the Left or the Right channel. With greater-than-stereo multichannel processing, the input signal for each stereo pair affects only those same channels, and likewise mono channels are affected only by their own input signal. For example, with an LCR multichannel format, the processing for the Center channel is only triggered when the Center channel input signal reaches the threshold. However, when the input signal reaches the threshold on the Left or the Right channel, processing is triggered for both the Left and the Right channel.

External All (with LFE)

When Ext-All (w/LFE) is selected, the plug-in uses the amplitude of a separate reference track or external audio source to trigger dynamics processing. Dynamics processing is applied equally to all channels when the input signal reaches the threshold on any input channel. With greater-than-stereo multichannel processing, the key signal triggers dynamics processing for all processed audio channels equally.

The reference track used for side-chain processing is selected using the Plug-In Key Input selector in the Plug-In window header.



Configuring a key input for side-chain processing

Internal-All (No LFE)

When Int-All (no LFE) is selected, dynamics processing is applied equally to all channels when the input signal reaches the threshold on any input channel, except for the LFE channel (if present). The LFE channel is processed independently based on its own input signal.

Internal Front/Rear

For LCRS or greater channel formats, when Int-Front/Rear is selected, dynamics processing is applied based on front channel inputs (LCR) and surround channel inputs (S) independently. For “.1” formats, the LFE channel is processed independently based on its own input signal.

Side-Chain Listen Mode

Listen mode lets you hear the input signal for the side-chain to the compressor. This can be either the external key input or the internal side-chain (including the applied filter).

To enable (or disable) Listen mode on the side-chain:

- Click the Listen button in the top-right corner of the Side-Chain section so that it is highlighted. To disable it, click the button again so that it is not highlighted.



Side-Chain Listen mode enabled

⚠ *Attenuation Listen and Side-Chain Listen can be enabled simultaneously, in which case Attenuation Listen is audible but Side-Chain Listen is not.*

Side-Chain Filter On/Off

You can use the Side-Chain input with or without filtering by enabling or disabling the Side-Chain Filter On/Off button.

To enable (or disable) filtering on the side-chain:

- Click the Side-Chain Filter On/Off button on the right side of the Side-Chain section so that it is highlighted. To disable it, click the button again so that it is not highlighted.



Side-Chain Filter enabled

Side-Chain Filter

Filter Frequency

The Freq control lets you set the center frequency for the selected Filter Type (from 20 Hz to 21.0 kHz).

Filter Q

When the Filter Type is set to Band Pass or Notch, the Q control is available. The Q control changes the width of the filter around the center frequency band. Higher Q values represent narrower bandwidths. Lower Q values represent wider bandwidths.

Filter Type

Four Filter Type options are available for side-chain processing:

Low Pass Select the Low Pass option to apply a low pass filter to the side-chain processing at the selected frequency.

High Pass Select the High Pass option to apply a high pass filter to the side-chain processing at the selected frequency.

Notch Select the Notch option to apply a notch filter to the side-chain processing at the selected frequency.

Band Pass Select the Band Pass option to apply a band pass filter to the side-chain processing at the selected frequency.

Side-Chain Processing Graph

The Side-Chain Processing Graph display shows the frequency curve for the selected Filter Type at the selected Filter Frequency.

Chapter 20: Pro Limiter

Avid Pro Limiter is available in DSP, Native, and AudioSuite formats. Pro Limiter provides true peak limiting. Pro Limiter limits incoming audio to the True Peak of the signal, to prevent inter-sample peaks that could introduce distortion during encoding or analog conversion.

Pro Limiter complies with the ITU-R BS.1770-3 loudness metering standard, including True Peak, Integrated Loudness, and Loudness Range measurements, and is suitable for both EBU R128 and ATSC A/85 (CALM Act) broadcast workflows. Pro Limiter also provides a unique Character knob that lets you add soft saturation for more loudness and greater gain reduction, without the unwanted digital artifacts of standard brick wall limiters.

Use Pro Limiter to ensure that your mix output never exceeds digital 0 dB when hitting the digital-to-analog converters on your audio interface.

Pro Limiter supports 44.1 kHz, 48 kHz, 88.2 kHz, 96 kHz, 176.4 kHz and 192 kHz sample rates.

Pro Limiter supports mono, stereo, and greater-than-stereo multichannel formats up to 7.1.

⚠ *Greater-than-stereo formats are only available with Pro Tools HD.*



Pro Limiter

Pro Limiter Metering

Pro Limiter uses sample peak meters for Input and Output signals.

The Peak Hold value is displayed numerically at the top of the meter and the Peak Hold indicator appears as a thin orange line in the meter. This provides highly accurate visual metering correlation with the audio signal.

Input and Output meters use the following color coding:

Dark Blue Indicates nominal levels from -90 dB to -20 dB.

Light Blue Indicates pre-clipping levels, from -20 dB to 0 dB.

Yellow Indicates full scale levels from 0 dB to $+6$ dB.

Gain Reduction meters are orange for the entire dynamic range displayed.

Pro Limiter Input Section

The Input section provides input metering and controls for adjusting the level of the input signal and the display of the Input meters.

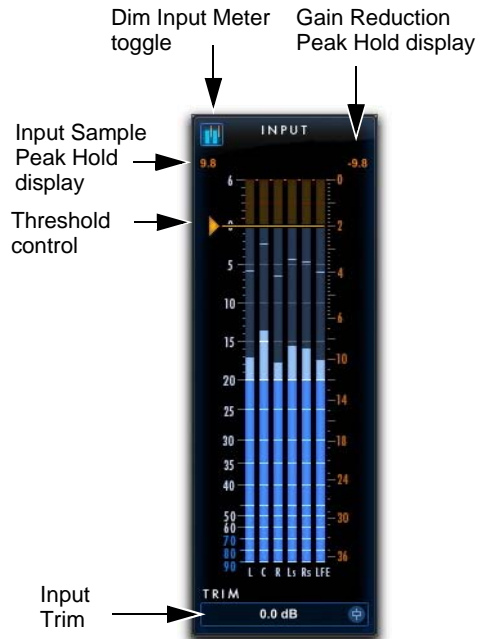

Input section with Meters

Input Trim

The Input Trim control sets the input gain of the plug-in before processing, letting you boost or attenuate gain at the plug-in input stage.

To trim the level of the input signal, do one of the following:

- Click in the Input Level field to type a value (-30.0 dB to $+30.0$ dB).
- Click the Input Trim control and drag up or down to adjust the Input Trim setting.

Dim Input Meter Toggle

Pro Limiter provides a Dim Input Meter option that dims the input meters while highlighting the attenuation meters. This lets you visually focus more on the gain reduction applied rather than on the incoming signal levels.

To toggle the Dim Input Meter option on or off:

- Click the Dim Input Meter toggle in the upper-left corner of the Input section.

Input and Gain Reduction Peak Hold Displays

Pro Limiter displays the Input Sample Peak Hold value (in dB) at the upper left corner of the Input meters and the Gain Reduction Peak Hold value (in dB) at the upper right corner of the Input meters.

Input Sample Peak Hold Display Shows the last greatest sample peak value from the input signal (on any channel).

Gain Reduction Peak Hold Display Shows the last greatest attenuation value applied to the input signal.

To reset either the Input or Gain Reduction Peak Hold display value:

- Click the display value you want to reset.

Input Meters

The Input meters show peak signal levels before processing. The Input meter scaling is shown on the left side of the Input meters (from -90 dB to $+6$ dB).

Gain Reduction Meters

The Gain Reduction meters are interleaved with the Input meters. Gain Reduction meters show the amount of gain reduction applied to the Input signal. The gain reduction amount varies depending on the level of the Input signal, as well as the Threshold and Character settings.

The Gain Reduction meter scaling is shown on the right side of the Input meters (from 0 dB to -36 dB).

To better see the Gain Reduction meters, you can dim the Input meters (see “Dim Input Meter Toggle” on page 119).

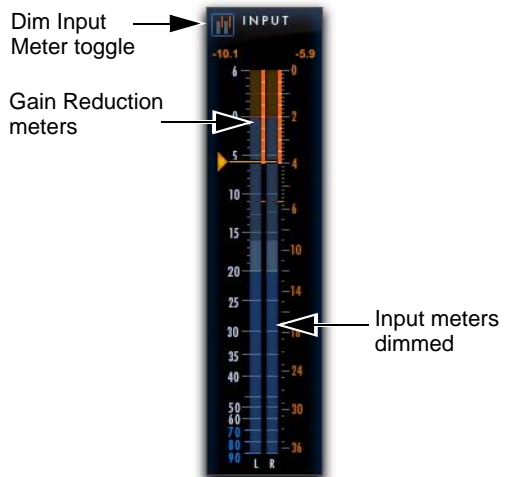

Gain Reduction meters shown with Input meters dimmed

Pro Limiter Output Section

The Output section provides output metering and controls for adjusting the level of the output signal.

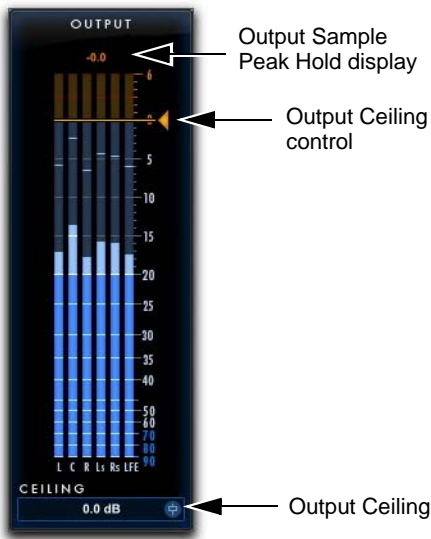

Output section with Meters

Output Meters

The Output meters show peak signal levels after processing. The Output meter scale is shown on the right side of the Output meters (from -90 dB to $+6$ dB).

Output Sample Peak Hold Display

Pro Limiter provides a numerical display for the output sample peak hold value (in dB) above the output meters. To reset the value, click it.

Pro Limiter Controls

Pro Limiter provides controls for setting the Threshold, Ceiling, Character (soft-saturation limiting), and Release time.

Threshold

The Threshold control sets the level an input signal must exceed to trigger limiting. Signals that fall below the Threshold setting are unaffected.

To adjust the input threshold, do one of the following:

- Click in the Threshold field to type a value (-30 dB to 0 dB).
- Click the Threshold control and drag up or down.
- Click the Threshold control on the Input meters and drag up or down.

Ceiling

The Ceiling control sets the maximum output level of the audio signal from -30 to 0 dBTP (dB relative to full scale, measured as a true-peak value).

To adjust the output ceiling, do one of the following:

- Click in the Ceiling field (either below the Ceiling control or below the Output meters) to type a value between -30 to 0 dBTP.
- Click the Ceiling control and drag up or down.
- Click the Output Ceiling control on the Output meters and drag up or down.

 *Shift-click and drag either the Ceiling control or the Threshold control to link both controls and adjust them to match the same value.*

Character

The **Character** control adds soft-saturation processing with no additional gain before applying limiting.

Release

The **Release** control sets the length of time it takes to cease limiting after the input signal crosses the threshold.

Release times should be set long enough that if signal levels repeatedly rise above the threshold, the gain reduction “recovers” smoothly. If the release time is too short, the gain can rapidly fluctuate as the limiter repeatedly tries to recover from the gain reduction. If the release time is too long, a loud section of the audio material could cause gain reduction that continues through soft sections of program material without recovering.

When the **Auto Release** option is enabled, the **Release** control is overridden and the **Release** value display is grayed out.

Channel Linking

Pro Limiter provides four different options for determining how limiting processing is applied to greater-than-stereo multi-channel formats.

Stereo Pairs When selected, limiting is only applied to the **Left** and **Right** stereo pairs only when either the **Left** or **Right** incoming signal exceeds the **Threshold** setting. Similarly, limiting is only applied to the **Left Surround** and **Right Surround** stereo pairs only when either the **Left Surround** or **Right Surround** incoming signal exceeds the **Threshold** setting. The processing of the **Center** channel (if present) is applied separately only when the incoming signal on for the **Center** channel exceeds the **Threshold** setting.

All (w/LFE) When selected, limiting is applied to all incoming channels whenever any channel exceeds the **Threshold** setting.

All (no LFE) When selected, limiting is applied to all incoming channels whenever any channel, except the **LFE** channel, exceeds the **Threshold** setting.

Front/Back When selected, limiting is only applied to the **Left**, **Center** (if present), and **Right** channels only when the incoming signal on any front channel input exceeds the **Threshold** setting. Limiting is only applied to the **Surround** channels only when the incoming signal on any surround (or back) channel) exceeds the **Threshold** setting.



*Insert a multi-mono instance of **Pro Limiter** to ensure no linking between channels. Each channel will trigger its own processing independently of the other channels.*

Auto Release

When **Auto Release** is enabled, **Pro Limiter** overrides the **Release** setting and automatically adjusts the limiter release time based on changes in the program material. When the **Auto Release** toggle is disabled, you can set the limiter release time manually using the **Release** control.

Listen

Enable **Listen** to isolate the processed part of the audio signal. This can help you hear what parts of the input signal are triggering limiting, which, in turn, can help you better understand the characteristics of the current **Threshold**, **Character**, and **Release** settings.

Pro Limiter Loudness Numeric Displays

Pro Limiter provides numeric displays that show the current loudness or peak level of the processed signal. Note that Pro Limiter conforms to the ITU-R BS.1770-3 standard for loudness metering. The numeric loudness values generated by Pro Limiter can be used for both EBU R128 and ATSC A/85 CALM Act loudness compliance.

Integrated Displays the current integrated level of the processed signal level in LUFS.

Range Displays the range of the processed signal level over time in LU.

True Peak Displays the true peak hold value of the output signal in dB.

Short Term Displays the short term output signal level in LUFS.

About LUFS, LU, and dB

LUFS (Loudness Unit, Referenced to Full Scale) is a unit of measurement that expresses loudness levels on an absolute scale. LU (Loudness Unit) is a unit of measurement for differences between loudness levels (loudness levels on a relative scale). For example, program material that has a loudness level of -23 LUFS will be 2 LU quieter than program material that has a loudness level -21 LUFS. LU can also be used as the units for loudness levels relative to the target level. Note that since K-weighting has been adopted as the standard for loudness units, LUFS is equivalent with LKFS in Pro Limiter.

Decibels (dB) are an expression of the ratio of two levels: the level to be described (or measured) and a reference level. Letters after dB (such as dBm) signify the reference level. For example, dBm is referenced to 1 milliwatt, whereas dBu is refer-

ences to $0.775V_{rms}$. LUFS is a measurement on a decibel scale and is relative to the loudness level of a stereo (front left and front right) 1 kHz tone peaking at 0 dBFS (0 decibels at full scale).

Pro Limiter Histogram and Loudness Meters

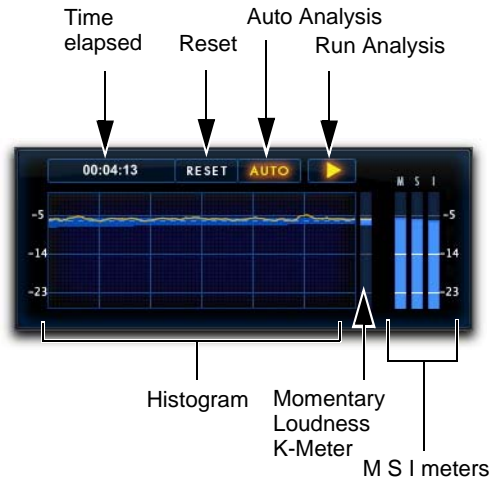

Pro Limiter Histogram and Loudness meters

Histogram

Pro Limiter provides a histogram that shows a graphic representation of loudness over time within a window of 60 seconds. The graph displays True Peak levels as a yellow line and the range of loudness over time as a blue shadow around the peak level line.

Time Elapsed Displays the amount of time elapsed since the current analysis pass started in hours, minutes, and seconds (00:00:00).

Reset Analysis Click the Reset button to reset the analysis.

Auto Analysis When Auto is enabled, Pro Limiter automatically pauses the analysis pass when the Pro Tools transport is stopped. This means that the drop in levels will not be reported with the Integrated and Range values. Note that it may be useful to disable Auto if you want to include a live audio signal being monitored through Pro Tools while the transport is stopped.

Run Analysis Click the Run Analysis (Play) button to enable (lit) or disable (unlit) analysis reporting in the histogram while the Pro Tools transport is stopped. Pro Limiter runs the analysis when the Pro Tools transport is running regardless of whether or not the Run Analysis option is enabled. Note that when the Auto analysis option is enabled, the Run Analysis option is overridden.

Loudness Meters

The Loudness meters to the right of the histogram show the level of the summed output of Pro Limiter. The meters range from 0 LUFS down to -50 dB LUFS. -23 LUFS is a common standard loudness reference level.

Momentary Loudness Provides a display of the loudness range (as in the histogram). The current peak level is shown as a yellow line using K-weighted metering.

Momentary Loudness Meter (M) Graphically displays the current true peak level.

Short Term Loudness Meter (S) Graphically displays the current short term output level.

Integrated Loudness (I) Graphically displays the current integrated level of the processed signal using K-weighted metering.

💡 *K-weighted metering implements a filter curve that models the human ear's perception of loudness. It is an integral part of the ITU-R BS.1770 standard for loudness metering.*

Adjusting the Loudness Meters View

The Loudness meters show a range of 27 LUFS. The default view shows from -14 to -41 LUFS. Drag up or down in the histogram to adjust the viewed range for loudness metering from 0 LUFS on the upper end down to -50 LUFS on the lower end.

AudioSuite Processing with Pro Limiter

When used as an AudioSuite plug-in, Pro Limiter does not provide real-time analysis data in the histogram or the loudness meter. Once you have rendered the audio selection with Pro Limiter processing, Pro Limiter loudness reporting updates to display the results of the processing.



Pro Limiter AudioSuite plug-in

AudioSuite Processing with Pro Limiter Loudness Analyzer

Use the Pro Limiter Loudness Analyzer to check loudness levels before rendering Pro Limiter processing if you need to read the current loudness measurements of your program material.

To analyze audio using the Pro Limiter Loudness Analyzer:

- 1 Make an audio selection in the Edit window.
- 2 Choose AudioSuite > Other > Pro Limiter Loudness Analyzer.
- 3 Click Analyze.

The Loudness numerical displays update to show the analyzed values (for information on the Loudness numerical displays, see “Pro Limiter Loudness Numeric Displays” on page 122).



Pro Limiter Loudness Analyzer AudioSuite plug-in

 *With the Pro Limiter Loudness Analyzer, the Preview and Render buttons do not do anything useful. They are simply present as part of the AudioSuite plug-in framework.*

Chapter 21: Pro Multiband Dynamics

Avid Pro Multiband Dynamics is an AAX plug-in (DSP, Native, and AudioSuite) that provides 4-band dynamics processing for Pro Tools systems, along with monitoring across all frequencies in the FFT (Fast Fourier Transform) display. You can control Pro Multiband Dynamics parameters using graphic controls laid over the FFT display for immediate visual feedback. You can also edit parameters using knobs, sliders, and numeric entry fields in each Frequency Band pane.

Pro Multiband Dynamics supports 44.1 kHz, 48 kHz, 88.2 kHz, 96 kHz, 176.4 kHz, and 192 kHz sample rates.

Pro Multiband Dynamics also supports mono, stereo, and greater-than-stereo multichannel formats up to 7.1.

! *Greater-than-stereo formats are only available with Pro Tools | HD Software.*



Pro Multiband Dynamics plug-in

FFT Display and Controls

Pro Multiband Dynamics splits the incoming audio signal into up to four separate Frequency Bands: Low, Low Mid, High Mid, and High. Each Frequency Band can be processed independently. Additionally, each Frequency Band can be routed to the channel inputs of other tracks (see “Pro Multiband Dynamics and Multiband Splitter Plug-In Sends” on page 135). Pro Multiband Dynamics uses an 8th-order Linkwitz-Riley crossover network in order to split the audio signal into up to four separate Frequency Bands, ensuring that the output signal can be perfectly reconstructed.

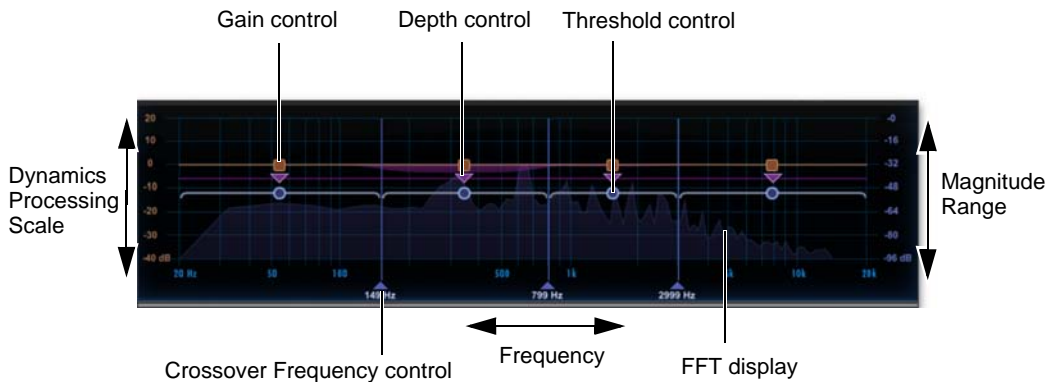

FFT display and controls

The FFT display plots the real-time magnitude of the audio signal (y-axis) versus frequency (x-axis). The frequency range is marked from 20 Hz to 20 kHz along the bottom of the display. The magnitude range, marked on the right of the display, shows the real-time magnitude of the signal in dB. Gain processing (reduction or expansion) is shown on the display as a purple fill. The height of the fill corresponds to the amount of dynamics processing that is being applied to that band's signal.

Use the dynamics processing scale, marked on the left of the display, to measure the adjustment of Gain, Depth, and Threshold controls. (See “Band Pane Controls and Indicators” on page 130 for detailed information on these controls.)

To adjust the Gain control for a Frequency Band, do one of the following:

- Click the Gain slider and drag it left or right.
- Click the Gain label, type a value, and press Enter.
- Click the red square Gain control icon on the FFT display and drag it up or down.



Adjusting the Gain control

To adjust the Depth control for a Frequency Band, do one of the following:

- Click the Depth knob and drag it left or right, or up or down.
- Click the Depth numeric entry field, type a value, and press Enter.
- Click the purple triangle Depth control icon on the FFT display and drag it up or down.



Adjusting the Depth control

To adjust the Threshold control for a Frequency Band, do one of the following:

- Click the Threshold knob and drag it left or right, or up or down.
- Click the Threshold numeric entry field, type a value, and press Enter.
- Click the Threshold control to the left of the Band meter and drag it up or down.
- Click the blue circle Threshold control icon on the FFT display and drag it up or down.



Adjusting the Threshold control

Crossover Frequency Controls

Use the Crossover Frequency controls (up to three are available depending on how many of the four possible frequency bands are enabled) to set the frequency split between bands.

To adjust the frequency split between adjacent bands, do one of the following:

- Drag the Crossover Frequency control to the left or right.
- Click the Crossover Frequency numeric entry field, type a value, and press Enter.



Adjusting Crossover Frequency control

FFT Display Options

Pro Multiband Dynamics lets you choose to show the Input signal (pre-processing) or the Output signal (post-processing) in the FFT display. It also lets you show or hide the Gain and Threshold controls in the FFT display, as well as hide the FFT amplitude graph. This can be useful if you want to reduce visual clutter in the plug-in window.

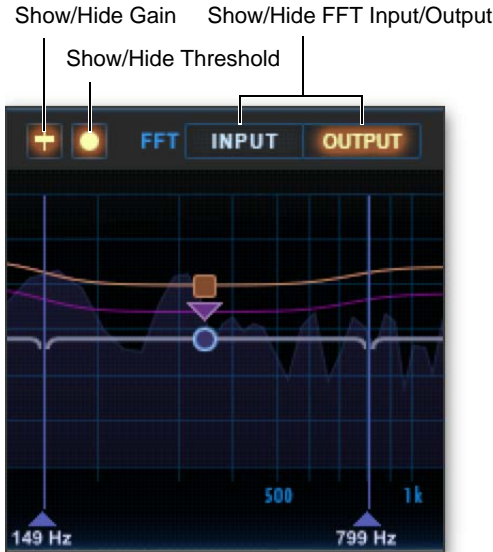

FFT Display options

To hide (or show) the Gain controls on the FFT display:

- Click the Show/Hide Gain icon so that it is not lit (or click the Show/Hide Gain icon so that it is lit).

To hide (or show) the Threshold controls on the FFT display:

- Click the Show/Hide Threshold icon so that it is not lit (or click the Show/Hide Threshold icon so that it is lit).

To show the Input signal in the FFT display:

- Click the FFT Input toggle so that it is lit.

To show the Output signal in the FFT display:

- Click the FFT Output toggle so that it is lit.

To hide the FFT amplitude graph:

- Click either the lit FFT Input toggle or the lit FFT Output toggle (whichever one is lit) so that it becomes unlit.

Input and Output Gain Controls

Pro Multiband Dynamics provides Input Gain (pre-processing) and Output Gain (post-processing) controls. Pro Multiband Dynamics lets you independently adjust the Input Gain from -36.0 dB to $+36.0$ dB and the Output Gain from -36.0 dB to $+12.0$ dB. These controls are located in the upper-left corner of the Plug-In window.

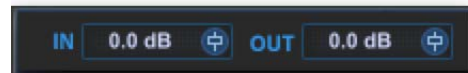

Input and Output Gain controls

To adjust the Input Gain to or the Output Gain from Pro Multiband Dynamics, do one of the following:

- Drag the fader icon, or drag in the numeric entry field.
- Click the numeric entry field, type a value, and press Enter.

Source Linking

The Linking selector lets you set how individual channels of a multichannel source signal are combined in each of the separate detectors (by band). The source signal can be the audio being processed by the Pro Multiband Dynamics, or it can be an external side-chain signal (see “Side-Chain Processing” on page 134).

The available Linking modes are: Stereo Pairs, All (w/LFE), All (no LFE), or Front/Rear.

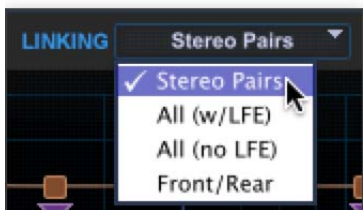

Selecting linked source channels for triggering dynamics processing

Internal Source—Stereo Pairs

When Stereo Pairs is selected on a greater-than-stereo multichannel track, the input signal for each stereo pair affects only those same channels, and likewise mono channels are affected only by their own input signal. For example, with an LCR multichannel format, the processing for the Center channel is only triggered when the Center channel input signal reaches the threshold. However, when the input signal reaches the threshold on the Left or the Right channel, processing is triggered for both the Left and the Right channel.

All (with LFE)

When All (w/LFE) mode is selected, the plug-in combines every channel into the same detector and applies dynamics processing on each channel identically. For example, when any signal channel crosses the threshold in a 5.1 surround format, all of the channels will be processed equally.

All (No LFE)

When All (no LFE) is selected, dynamics processing is applied equally to all channels when the input signal reaches the threshold on any input channel, except for the LFE channel (if present). The LFE channel is processed independently based on its own input signal.

Front/Rear

For LCRS or greater channel formats, when Front/Rear is selected, dynamics processing is applied based on front channel inputs (LCR) and surround channel inputs (S) independently. For .1 formats, the LFE channel is processed independently based on its own input signal.

Mini Multichannel Gain Reduction and Output Meters

Pro Multiband Dynamics provides mini Gain Reduction and Peak Meters for every possible channel output. These meters are located in the upper-right corner of the plug-in window. The eight channels of Gain Reduction Meters and the eight channels of Output Meters are always shown regardless of the channel width of the track on which Pro Multiband Dynamics is inserted. However, only active channels will show meter activity.

The channel ordering of the meters updates to match the selected channel width. For example, stereo shows on the first two meters from left to right, but 5.1 shows L, C, R, Ls, and Rs from left to right with the LFE always shown on the right-most meter.

The color coding under the Gain Reduction corresponds to the Channel Link mode: Channels with the same color are combined in the same detector (see “Source Linking” on page 128).



Gain Reduction and Output meters

Band Pane Controls and Indicators

Each of the four bands of Pro Multiband Dynamics provide a control pane with the same controls and indicators.



Band controls pane

Adjusting Controls in a Band Pane

Click the button controls to toggle them on or off. When toggled on, the text in the button lights.

Turn the knob controls by dragging up and down, or left and right.

Adjust the slider controls by dragging from left to right.

Click in a numeric field and type a number. Press Enter to commit the entered value. The Gain, Slope, Attack, and Release labels convert to numeric fields when you move the cursor over either the slider or the label. The labels for Gain, Slope, Attack, and Release can be edited by clicking the numeric field.

Band Pane Buttons

At the top of each Band pane are a set of buttons that let you enable/disable the band, solo the audio passing through the band, bypass dynamics processing on the band, link band controls, and toggle the band dynamics processing between being a compressor or an expander.



Band Pane buttons

Enable/Disable Band

The Enable/Disable Band button displays the band number. Click it to toggle the band on (lit) or off (unlit). Disabling a band results in the adjacent band taking over the frequency range occupied by the disabled band, and adjusts the number of Cross-over Frequency controls on the graph display.

Solo

The Solo button lets you solo or unsolo the band.

Link

When the Link button is enabled on more than one band, all controls are linked between these bands. Linked bands retain offsets between continuous controls.



To temporarily link the controls of all 4 bands, Shift-drag a control.



To temporarily unlink and adjust a control independently of all other linked bands, Control-click (Mac) or Start-click (Windows) and drag the control.

Auto

The Auto button lets you enable Automatic Gain Control. When Automatic Gain Control is enabled, the Gain setting changes when you change the Depth setting. However, when you change Gain, the Depth setting remains in a fixed relation to the Gain setting.

Flip

When Flip mode is enabled (lit), the operation of the band changes so that dynamics are adjusted when the input signal is below the threshold. By default, each band adjusts the dynamics when the input signal goes above the threshold. However, in Flip mode, the band functions as either a classic Downward Compressor or an Upward Expander, depending on the Depth control setting.

For example, if you enable Flip on all the bands and set the Depth controls to negative values, Pro Multiband Dynamics becomes a decent broadband noise reduction plug-in. If you have a signal source with a lot of high-end hiss, enable Flip mode on just the high-band and noise-reduce that band with downward expansion (while keeping the other bands as downward compressors).

To bring out the fine low-level details of a performance, enable Flip mode on the middle two bands and set the Depth controls to positive values. This increases the volume of subtle nuances while ensuring that the tone of anything above the threshold is unaffected.

Since Flip mode significantly changes the characteristics of the dynamics processing, the color of the Threshold and Depth controls change from blue (Flip mode disabled) to orange (Flip mode enabled).



For parallel processing workflows, you can use Flip mode to get results similar to parallel processing while avoiding phase issues or having to set up parallel compression routing. Pro Multiband Dynamics is not recommended for parallel dynamics processing as it can result in phase issues between the processed signal and the unprocessed signal. Like many multiband compressors, Pro Multiband Dynamics uses minimum-phase filters to ensure efficient low-latency processing. However, this results in a signal that does not phase-align with a parallel unprocessed signal.

Bypass

When Bypass is enabled, the input signal passes through the band without any dynamics processing.

Band Pane Meters

Each Band provides independent Level meters with Peak Hold indicators, as well as Gain Reduction meters with Gain Reduction/Expansion Peak indicators. Additionally, there is a Threshold control that lets you set the Threshold against the level meter.



Band Pane meters

Gain Reduction/Expansion Peak Indicator

Each band provides a numerical indicator for the peak gain reduction or expansion value in decibels.

Gain Reduction Meter

The Gain Reduction Meter displays the amount of gain reduction applied to the band.

Peak Indicators

The Peak Hold indicator appears as a thin line in the Level Meter. The Peak Gain Reduction indicator appears as a thin line in the Gain Reduction Meter. These provide highly accurate visual metering correlation with the frequency band's audio signal.

Threshold Control

The Threshold control lets you adjust the Threshold setting against the Level Meter.

Level Meter

The Level Meter indicates the band output level based on the following color coding:

Dark Blue Indicates nominal levels from -90 dB to -12 dB.

Light Blue Indicates pre-clipping levels, from -12 dB to 0 dB.

Yellow Indicates full scale levels from 0 dB to $+6$ dB.

Dynamics Controls

Threshold

The Threshold control sets the level that an input signal must exceed to trigger dynamics processing (from -60 dB to 0 dB). A band will be compressed if its level exceeds this setting. If the signal level falls below this value, no processing will occur on this band. You can also adjust the Threshold setting using the blue circle Threshold control on the FFT display or the Threshold control to the left of the band's level meter.

Depth

The Depth control sets the maximum amount of gain reduction or expansion applied to the input signal of the band (from -24 dB to $+24$ dB). For example, if you set Depth to -10 dB, no more than 10 dB of gain reduction is applied to the incoming signal. You can also adjust the Depth setting using the purple triangle Depth control on the FFT display.

Gain

The Gain control lets you boost or attenuate the output gain of the frequency band (from -24 dB to $+24$ dB). You can also adjust the Gain using the Red Square gain control icon on the FFT display.

Slope

The Slope control lets you adjust the dynamic curve for compression and expansion (from 0% to 100%). Slope is effectively a combined control for adjusting the Ratio and the Knee of the dynamics processor. Lower settings offer a lower ratio and a softer knee. Higher settings increase the ratio and provide a sharper knee.

When Slope is set to 0%, the effective Ratio is approximately 1:1.5. When Slope is set to 100%, the Ratio is 1:20.

At the same time, the knee ranges from about 1/2 of Depth in dB (min slope) to 0 dB (max slope).

Attack

The Attack control sets the attack time, or the rate at which gain is reduced after the input signal level crosses the threshold (from 100.0 microseconds to 1.0 second).

The smaller the value, the faster the attack. The faster the attack, the more rapidly gain change is applied to the signal. If you use fast attack times, you should generally use a proportionally longer release time, particularly with material that contains many peaks in close proximity.

 *The actual compression attack time is also dependent on the selected Detection mode. Each mode has its own attack and release times that are calculated in advance of compression processing. If a slower Detection mode is selected (such as AVG), the fastest possible actual attack time for compression can only be about 20 ms. The selected Detection mode similarly affects the compressor release time.*

Release

The Release control sets the length of time it takes for compression to be fully deactivated after the input signal drops below the threshold (from 1.0 millisecond to 10.0 seconds).

Release times should be set long enough that if signal levels repeatedly rise above the threshold, the gain reduction “recovers” smoothly. If the release time is too short, the gain can rapidly fluctuate as the compressor repeatedly tries to recover from the gain reduction. If the release time is too long, a loud section of the audio material could cause gain reduction that continues through soft sections of program material without recovering.

Detection Modes

Pro Multiband Dynamics provides several different detection options for determining how the compressor responds to the input signal.

To change the detection mode for the compressor:

- Click a detection mode from the options available at the bottom of the Band Controls pane.

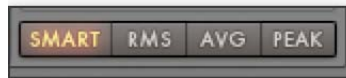

Detection mode options (Smart mode selected)

Detection options include the following:

Smart Select the Smart option for tracks with diverse input signals, or if you are simply not sure what detector works best with the given audio material. The Smart option analyzes the incoming signal and interpolates between the different detection modes as needed. This lets you apply a lot of compression without distortion or pumping.

RMS Select the RMS option to apply processing according to the detected RMS (Root Mean Square) amplitude of the input signal. The RMS option is similar to the Average option, but with a faster release time.

Average Select the Average option to apply processing according to the detected average amplitude of the input signal.

Peak Select the Peak option to apply processing according to the detected peak amplitude of the input signal. This mode provides the fastest detector response.

Side-Chain Processing

Dynamics processors operate by changing the level of the main input signal according to what is detected on a separate “key input” or “side chain.” Normally, the main input and the key input are fed from the same source signal, but some dynamics plug-ins can have the side chain fed from a separate, external signal. With external key side-chain processing, you can trigger dynamics processing using an external signal (such as a separate reference track or audio source) instead of the input signal.

On Pro Multiband Dynamics, the external side chain is processed through the same crossover network as the main signal, so the side chain of each band will contain only that band’s frequency range.

To use a key input for external side-chain processing on any frequency band:

- 1 Use a send bus or output bus on the track with the audio that you want to use for external side-chain processing
- 2 Click the Key Input selector and select the input or bus carrying the audio you want to use to trigger dynamics processing.



Bus 1 selected as the key input for side-chain processing

- 3 Enable side-chain processing on any of the frequency bands in Pro Multiband Dynamics.
- 4 Begin playback. The plug-in uses the input or bus that you chose as a key input to trigger its effect.

Side Chain Signal Level

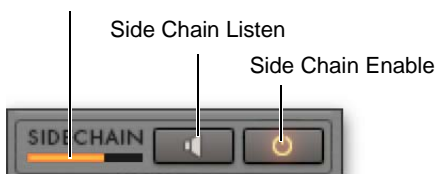

Side-Chain section

Side Chain Signal Level

The Side Chain Signal Level meter displays the level of the incoming side chain signal.

Side Chain Listen

Listen mode lets you hear the input signal of the side chain to the frequency band.

To enable (or disable) Listen mode on the side chain:

- Click the Listen button so that it is highlighted. To disable it, click the button again so that it is not highlighted.

Side Chain Enable

Pro Multiband Dynamics lets you enable sidechain processing on a band-by-band basis.

To enable (or disable) side-chain processing for a given frequency band:

- Click the Side Chain Enable button so that it is highlighted. To disable it, click the button again so that it is not highlighted.

Multiband Splitter Plug-In

Included with Pro Multiband Dynamics is a separate Multiband Splitter plug-in that lets you send audio by frequency band to other tracks using plug-in sends. This lets you split the audio signal by frequency bands for additional mixing and effects processing, but without any dynamics processing.

⚠ *VENUE and Media Composer do not support Multiband Splitter.*

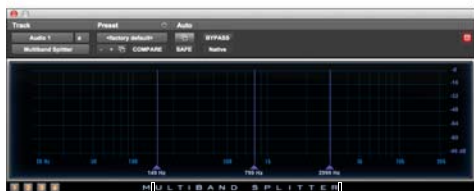

Crossover Frequency controls
Enable/Disable Band

Multiband Splitter

Enable/Disable Band

The Enable/Disable Band button shows the band number. Click it to toggle the Band on (lit) or off (unlit).

Crossover Frequency Controls

Use the Crossover Frequency controls (up to three are available depending on how many of the four possible frequency bands are enabled) to set the frequency split between bands.

To adjust the frequency split between adjacent bands:

- Drag the Crossover Frequency control to the left or right.

Pro Multiband Dynamics and Multiband Splitter Plug-In Sends

Both Pro Multiband Dynamics and Multiband Splitter plug-ins let you output signal on a band-by-band basis for routing to Auxiliary Input tracks or audio tracks for additional mixing and processing.

⚠ *VENUE and Media Composer do not support the auxiliary output signal feature of Pro Multiband Dynamics.*

To route the audio signal output of individual frequency bands from Pro Multiband Dynamics or Multiband Splitter:

- 1 Insert Pro Multiband Dynamics or Multiband Splitter on a track.
- 2 Adjust the Crossover Frequency controls.
- 3 Create an Auxiliary Input (or audio) track.
- 4 From the Auxiliary Input (or audio) track input selector, select a plug-in band.



Selecting the Low Band output from an instance of the Pro Multiband Dynamics plug-in as the input on an Auxiliary Input track

Chapter 22: Purple Audio MC77

Purple MC77 is a dynamics processing plug-in that is available in DSP, Native, and AudioSuite formats.

Purple MC77 supports 44.1 kHz, 48 kHz, 88.2 kHz, 96 kHz, 176.4 kHz and 192 kHz sample rates.

Purple MC77 operates as a mono, multi-mono, or stereo plug-in.



Purple Audio MC77

The Purple Audio MC77 is a spot-on digital replica of Andrew Roberts' acclaimed MC77 Limiting amplifier, which in turn is an update of his classic MC76 hardware unit. Representing a different take on the 1176-style FET limiter, the Purple Audio MC77 preserves every audio nuance and sonic subtlety of the classic originals.

Purple Audio MC77 Controls

Purple Audio MC77 has controls identical in name to those of the BF76, and which function similarly. For more information, see Chapter 10, “BF76.”

Chapter 23: Smack!

Smack! is a dynamics processing plug-in that is available in DSP, Native, and AudioSuite formats.

Smack! supports 44.1 kHz, 48 kHz, 88.2 kHz, 96 kHz, 176.4 kHz and 192 kHz sample rates.

Smack! supports mono, stereo, and greater-than-stereo multichannel formats up to 7.1.

! *Greater-than-stereo formats are only available with Pro Tools HD.*



Smack!

! *Smack! has no control to directly adjust the threshold level (the level that an input signal must exceed to trigger compression). The amount of compression will vary with the input signal, which is adjustable by the Input control.*

The Smack! compressor/limiter plug-in has the following features.

- Three modes of compression:
 - Norm mode emulates FET compressors, which can have faster attack and release times than electro-optical compressors. This mode lets you fine-tune compression precisely by adjusting the attack, release, and ratio controls.
 - Warm mode is based on Norm mode, but has release characteristics more like those of electro-optical limiters.
 - Opto mode emulates classic electro-optical limiters, which tend to have gentler attack and release characteristics than FET compressors. The attack, release and ratio controls are not adjustable in this mode.
- “Key Input” side-chain processing, which lets you trigger compression using the dynamics of another signal.
- Side-Chain EQ filter, which lets you tailor the compression to be frequency-sensitive.
- High Pass filter, which lets you remove “thumps” or “pops” from your audio.
- Distortion control, which lets you add different types of subtle harmonic distortion to the output signal.

Smack! Controls and Meters

Smack! includes controls for multiple compression modes and a VU meter.

Smack! Compression Mode Buttons

Smack! has three modes of compression: Norm (Normal), Opto, and Warm. Use the corresponding button to select a mode.



Norm, Warm, and Opto mode buttons

Norm Mode Button

Enable the Norm button to emulate FET compressors, which can have significantly faster attack and release times than opto-electrical-based compressors. It can be used for a wide range of program material and, with extreme settings, can be used for sound effects such as “pumping.”

In Norm mode, you can precisely adjust the Ratio, Attack, and Release controls to fine-tune the compression characteristics.



Some sustained low-frequency tones can cause waveform distortion in Norm mode. The release characteristics of Warm mode (which is based on Norm mode) can be used to remedy this distortion by reducing waveform modulation.

Warm Mode Button

Enable the Warm button for compression that is based on Norm mode, but which has program-dependent release characteristics. These characteristics, often described as “transparent” or “smooth,” can be less noticeable to the listener and can reduce waveform distortion caused by some sustained low-frequency tones.

As with Norm mode, Warm mode can be used for a wide range of program material including vocals or low-frequency instruments such as tom-toms or bass guitar. Extreme settings can be used to produce “pumping” effects. Like Norm mode, Warm mode lets you precisely adjust the Ratio, Attack, and Release controls to fine-tune the compression characteristics.

Opto Mode Button

Enable the Opto button to emulate opto-electro compressors. Opto mode produces “soft knee” compression with gentle attack and release characteristics, and is ideal for compressing thin vocals, bass guitars, kick drums, and snare drums. In Opto mode, only the Input and Output controls are available for adjusting the amount of compression. The Attack, Release, and Ratio controls are greyed out and cannot be manually adjusted.

Smack! Input Control

In all Smack! compression modes, Input adjusts the level of input gain to the compressor. For more compression, increase the amount of input gain. For less compression, reduce the amount of input gain.



Setting the Input and Output controls to 5 is equal to unity gain at a compression ratio of 1:1.

Smack! Attack Control

In Norm and Warm modes, Attack controls the rate at which gain is reduced after the input signal crosses the threshold.

 *This control is not available in Opto mode.*

Set this control to 0 for the fastest attack time, or to 10 for the slowest attack time. Depending on the program material and the parameters used, this represents an approximate range of 100 μ s to 80 milliseconds.

Smack! Ratio Control

In the Norm and Warm modes, Ratio controls the *compression ratio*, or the amount of compression applied as the input signal exceeds the threshold. For example, a 2:1 compression ratio means that an input level that is 2 dB above the threshold will be attenuated, resulting in an output level that is 1 dB over the threshold.

 *This control is not available in Opto mode.*

 *Smack! has no control to directly adjust the threshold level (the level that an input signal must exceed to trigger compression). The amount of compression will vary with the input signal, which is adjustable by the Input control.*

As you increase the Ratio control, Smack! goes from applying “soft-knee” compression to “hard-knee” compression, as follows:

- With soft-knee compression, gentle compression begins and increases gradually as the input signal approaches the threshold. This creates smoother compression.
- In hard-knee compression, compression begins when the input signal exceeds the threshold. This can sound abrupt, and is ideal for limiting or de-essing.

Smack! compression ratios range from subtle compression to hard limiting. At ratios of 10:1 and higher, Smack! functions as a limiter. Selecting the Smack! setting lowers the threshold slightly and applies hard limiting, which keeps the output level constant regardless of the input level. (This setting can also be used for extreme compression effects.)

Smack! Release Control

In Norm and Warm modes, Release controls the length of time it takes for the compressor to be fully deactivated after the input signal drops below the threshold level. If the release time is too short, distortion can occur on low-frequency signals.

 *This control is not available in Opto mode.*

Set this control to 0 for the fastest release time, or to 10 for the slowest release time. Depending on the program material and the parameters used, this represents an approximate range of 15 ms to 1 second for Norm mode (or the primary release of Warm mode).

Smack! Output Control

In all Smack! compression modes, Output adjusts the overall output gain, which lets you compensate for heavily compressed signals by making up the resulting difference in gain.

When you apply Smack! to stereo or multichannel tracks, the Output control determines master output levels for all channels.

Set this control to 0 for no output gain (silence), or to 10 for the loudest output gain. This represents an approximate range of +40 dB.

 *Setting the Input and Output controls to 5 is equal to unity gain at a compression ratio of 1:1.*

Smack! Side-Chain EQ Filter

The side-chain is the signal path that a compressor uses to determine the amount of gain reduction it applies to the signal being compressed. This signal path is derived from the *input signal* or *Key Input*, depending on the user's selection.

When enabled, the Side-Chain EQ filter lets the user tailor the equalization of the side-chain signal so that the compression becomes frequency-sensitive.

 See “Using the Smack! Side-Chain Input” on page 142 for more information on using the Side-Chain EQ on a Key Input.

The Side-Chain EQ filter has the following settings:

High Pass Makes the compressor's detector less sensitive to low frequencies in the input signal or Key Input by rolling off at a rate of 6 dB per octave. For example, you might use this setting on a mix to prevent a bass guitar or bass drum from causing too much gain reduction.



High Pass Side-Chain EQ

Band-Emphasis Makes the compressor's detector more sensitive to mid-to high frequencies in the input signal or Key Input by boosting those frequencies in the side-chain signal. For example, you might use this setting to reduce sibilance in vocal tracks.



Band-Emphasis Side-Chain EQ

Combined Enables the High Pass and peak settings simultaneously to make the compressor's detector more sensitive to high frequencies and less sensitive to low frequencies.



Combined Side-Chain EQ

Off Disables the Side-Chain EQ control.

Smack! Distortion Control

When enabled, Distortion adds subtle second-order and third-order harmonic distortion to the output signal.

- Odd harmonics produce waveforms that are more square-shaped and are often described as “harsh” sounding.
- Even harmonics produce waveforms with more rounded edges and are often described as “smooth” sounding.

The amount of distortion that Smack! applies to the input signal depends on both the level of the input signal and the amount of compression being applied.

Odd Applies mostly odd (and some even) harmonics to the distortion.

Even Applies mostly even (and some odd) harmonics to the distortion.

O+E Applies an equal blend of odd and even harmonic distortion.



The Output control has no effect on the level of distortion applied to the signal.

Smack! HPF Toggle Switch

When enabled, the HPF (high pass filter) toggle switch gently rolls off audio frequencies lower than 60 Hz in the output signal at a rate of 6 dB per octave.

This is especially useful for removing “thumps” or “pops” from vocals, bass, or kick-drums.

Smack! VU Meter

The VU meter displays the amount of input level, output level, or gain reduction from compression, depending on the current Meter Mode button setting. It is calibrated to a reference level of $-14 \text{ dBFS} = 0 \text{ VU}$.

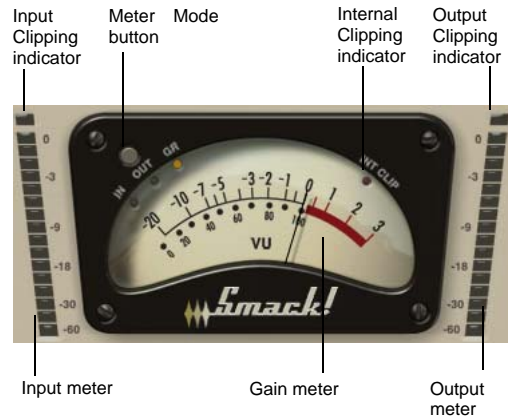

VU Meter

Meter Mode Button and Clip Indicators

The Meter Mode button toggles between displaying three display modes, as follows:

In Displays the input signal level, referenced to $-14 \text{ dBFS} = 0 \text{ VU}$.

Out Displays the output signal gain, referenced to $-14 \text{ dBFS} = 0 \text{ VU}$.

GR Displays the amount of gain reduction applied by the compressor.

Input and Output Meters

The Input and Output meters indicate input and output signal levels in dBFS (dB relative to full scale or maximum output).

The Internal Clipping indicator (labelled “INT CLIP”) turns red when the signal exceeds the available headroom. Clicking the Internal Clipping indicator clears it. Alt-clicking (Windows) or Option-clicking (Mac) clears the clip indicators on all channels.

Using the Smack! Side-Chain Input

Smack! provides side-chain processing capabilities. Compressors typically use the detected amplitude of their input signal to cause gain reduction. This split-off signal is called the *side-chain*. However, an external signal (referred to as the *Key Input*) can be used to trigger compression.

A typical use for external side-chain processing is to control the dynamics of one audio signal using the dynamics of another signal. For example, you could use a lead vocal track to duck the level of a background vocal track so that the background vocals do not interfere with the lead vocals.

 *The Side-Chain EQ filter lets you tailor the equalization of the side-chain signal so that the compression becomes frequency-sensitive. See “Smack! Side-Chain EQ Filter” on page 140 for more information.*

To use an external Key Input to trigger compression:

- 1 Insert Smack! on a track you want to compress using external side-chain processing.
- 2 On the audio track or Auxiliary Input that you want to specify as the Key Input (the signal that will be used to trigger compression), click the Send button and select the bus path to the track that will use side-chain processing.

 *The Key Input must be monophonic.*

- 3 In the track that you are compressing, click the instance of Smack! in the Inserts pop-up menu.
- 4 In the Smack! plug-in window, click the Key Input menu, and select the input or bus path that you have designated as the Key Input.
- 5 Begin playback. Smack! uses the input or bus that you selected as a Key Input to trigger its effect.
- 6 To fine-tune the amount of compression, adjust the send level from the Key Input track.

 *When you are using a Key Input to trigger compression, the Input control has no effect on the amount of compression.*

- 7 To tailor the side-chain signal so that the detector is frequency-sensitive, use the Side-Chain EQ filter (see “Smack! Side-Chain EQ Filter” on page 140 for more information).

Part IV: Pitch and Time Shift Plug-Ins

Chapter 24: Pitch II

Pitch II is a pitch-shifting plug-in that is available in DSP, Native, and AudioSuite formats. Pitch II is designed for a variety of audio production applications, ranging from pitch correction of musical material to sound design.

Pitch II supports 44.1 kHz, 48 kHz, 88.2 kHz, and 96 kHz sample rates for all plug-in formats. Pitch II also supports 176.4 kHz and 192 kHz sample rates for Native and AudioSuite plug-in formats.

Pitch II is available in mono, mono-to-stereo, and stereo channel formats.

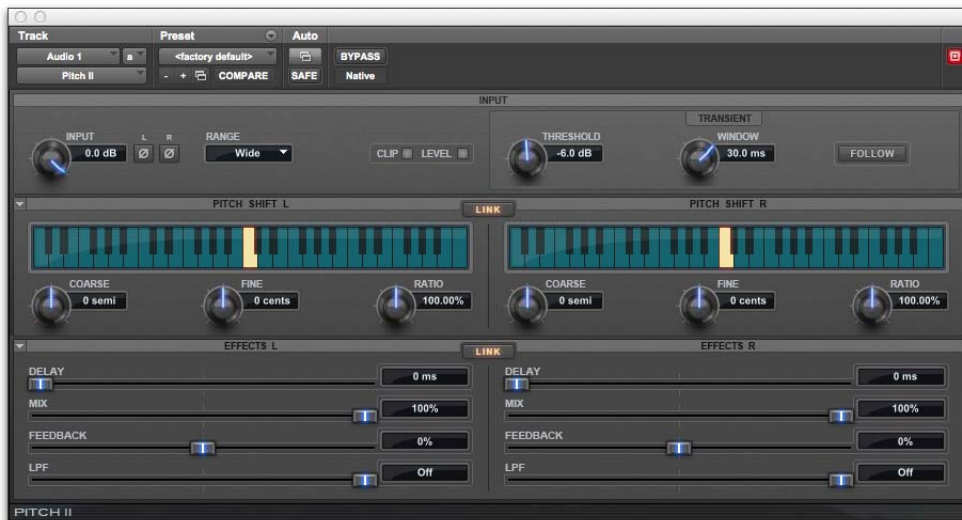

Pitch II (stereo)



Pitch II plug-in (mono)

Pitch processing typically uses the technique of varying sample playback rate to achieve pitch transposition. Changing audio sample playback rate results in the digital equivalent of vari-speeding with tape. This is usually unsatisfactory since it changes the overall duration of the material.

Pitch transposition with Pitch II involves a much more complex technique. Pitch II digitally re-aligns portions of the re-sampled audio waveform itself, while using de-glitching crossfades to minimize undesirable artifacts. The result is a processed signal that is transposed in pitch, but still retains the same overall duration of the original, unprocessed signal.

Pitch II Controls

Input and Transient Controls



Input and Transient controls

Input The Input control lets you attenuate the gain of the input signal from -6.0 dB to 0 dB to prevent clipping in the pitch shift algorithm.

Input Polarity The Input Polarity button inverts the polarity of the input signal, to help compensate for phase anomalies occurring in multi-microphone environments, or because of mis-wired balanced connections. The stereo version of Pitch II provides adjacent left and right channel Input Polarity buttons.

Range The Range selector lets you adjust the range of frequencies (Low, Mid, High, Wide) used for pitch detection. For most program material, the Wide setting should work well for pitch detection and transposition. If you encounter undesirable frequency artifacts with pitch transposition, experiment with other settings. Set this parameter to match the expected frequency content of source material. For example, when working with a bass part, set Range to Low. When pitch-shifting audio from material similar to a soprano vocalist or a violin, set Range to High.

Clip Indicator The Clip indicator shows whether clipping has occurred on output. It is a clip-hold indicator. If clipping occurs at any time, the clip light will remain on. To clear the Clip indicator, click it. Long delay times and high feedback times increase the likelihood of clipping.

Level Indicator The Level indicator shows the presence of an input signal.

Threshold Pitch II detects and responds to transients in the incoming audio signal to prevent “smearing” of sharp attacks (such as drum hits or vocal plosives). The Threshold control (–40 dB to 0 dB, and Off) determines how strong a transient needs to be in order to be recognized by the pitch detection algorithm. If you encounter undesirable frequency artifacts in the middle of long held notes, try raising the Threshold setting. If audio transients are obscured in the transposed signal, try lowering the Threshold setting.

Window Pitch II changes the pitch by splitting the incoming audio up into small grains (6.0 ms to 42 ms), re-sampling those grains, and adding those grains back together. The Window control determines the size of the grains. If you are working with long pad-like material such as legato strings, then increasing the Window size may improve audio quality; having too short of a Window in this situation may result in robotic or buzzy sounding audio. If you are pitch-shifting material with sharp transients, such as a drum part, reducing the Window size improves transient response; having too long of a Window in this situation may make the audio sound smeared and choppy.

Follow Enable Follow to match the overall dynamic envelope of the source audio. If pitch-shifted audio does not match the same decay sound as the original, turning Follow on may improve the sound. In most cases, however, leaving Follow off should sound just fine.

Pitch Shift Controls



Pitch Shift controls

Keyboard (Relative Pitch Transposition) Click any note on the keyboard to set a relative pitch transposition value that will be applied to the audio signal. The “C” key in the middle of the keyboard represents the original pitch of the incoming signal: if the C in the middle of the keyboard is selected, there is no pitch transposition. Click any other key to transpose the pitch of the incoming signal by the interval difference between middle C and the selected key. For example, if the E-flat key above middle C is selected, Pitch II transposes the incoming signal up a minor third (or 3 semitones). The Coarse control and the Keyboard control are linked.

Coarse This control adjusts the pitch of a signal in semitones over a two octave range. Pitch changes are indicated in number of semitones.

Fine This control controls the pitch of a signal in cents (hundredths of a semitone) over a 100 cent range. The range of this control is –50 to +50 cents.

Ratio The Ratio control lets you set the transposition between the pitch of the incoming signal and the selected transposition value as a percentage. The Ratio setting is linked with the Coarse and Fine settings.

Link (Stereo Only) Enable the Link option to link the controls for the left and right channels.

Show/Hide Panel



Show/Hide panel controls

Click the Show/Hide triangle in the upper left corner of the Pitch Shift panel to show or hide the panel. Hiding the Pitch Shift panel can be useful for conserving screen space.

Effects Controls



Effects controls

Delay The Delay control lets you set the delay time between the original signal and the pitch-shifted signal. It has a maximum setting of 1000 milliseconds. You can use the Delay control in conjunction with the Feedback control to generate a single pitch-shifted echo, or a series of echoes that rise in pitch.

Mix The Mix control lets you adjust the ratio of dry signal to effected signal in the output. In general, this control should be set to 100% wet, unless you are using the plug-in in-line on an Insert for an individual track or element in a mix. This control can be adjusted over its entire range with little or no change in output level.

Feedback The Feedback control lets you set the amount and type of feedback (positive or negative) applied from the output of the Delay effect back into its input. It also controls the number of repetitions of the delayed signal. You can use it to produce effects that spiral up or down in pitch, with each successive echo shifted in pitch.

LPF The LPF (Low Pass Filter) control lets you set the frequency under which audio signal is passed. The control can be set between 10 Hz and 22.05 kHz.

Chapter 25: Time Shift

Time Shift is an AudioSuite plug-in that provides high quality time compression and expansion (TCE) algorithms and formant correct pitch-shifting.

Time Shift is ideal for music production, sound design, and post production applications. Use it to manipulate audio loops for tempo matching or to transpose vocal tracks using formant correct pitch shifting. You can also use it in audio post production for pull up and pull down conversions as well as for adjusting audio to specific time or SMPTE durations for synchronization purposes.



Time Shift

Time Shift Controls

Time Shift controls are organized in the following four sections:

Audio Use the controls in the Audio section to select the most appropriate time compression and expansion algorithm (mode) for the type of material you want to process, and to attenuate the gain of the processed audio to aid clipping.

Time Use the controls in the Time section to specify the amount of time compression or expansion you want to apply.

Formant or Transient Use the controls in the Formant or Transient section to adjust either the amount of formant shift or the transient detection, depending upon which mode you have selected in the Audio section. The Formant section is only available when Monophonic is selected as the Audio Mode. The Transient section is available with slightly different controls depending on whether Polyphonic or Rhythmic is selected as the Audio Mode.

Pitch Use the controls in the Pitch section to apply pitch shifting. Pitch shifting can also be formant correct if you select the Monophonic audio setting.

Time Shift Audio Controls

The Audio section of Time Shift provides controls for specifying the type of audio you want to process and gain attenuation of the processed signal to avoid clipping.



Time Shift, Audio section

Mode

The Audio Mode pop-up menu determines the following types of TCE and pitch shift algorithm for processing audio:

Monophonic Select Monophonic for processing monophonic sounds (such as a vocal melody).

Polyphonic Select Polyphonic for processing complex sounds (such as a multipart musical selection).

Rhythmic Select Rhythmic for processing percussive sounds (such as a mix or drum loop).

Rhythmic mode uses transient analysis for time shifting. If you select audio with no apparent transients, or set the Transient Threshold control to a setting above any detected transients, Time Shift assumes a “virtual-transient” every three seconds to be able to process the file. Consequently, the file should be 20 bpm or higher (one beat every three seconds) to achieve desirable results. For material that has no apparent transients, use Monophonic or Polyphonic mode.

Varispeed Select Varispeed to link time and pitch change for tape-like pitch and speed change effects, and post production workflows.

Range

The Audio Range pop-up menu determines the following frequency ranges for analysis:

Low For low-range material, such as a bass guitar, select Low.

Mid For mid-range material, such as male vocals, select Mid. In Monophonic mode, Mid is the default setting and is usually matches the range of most monophonic material.

High For material with a high fundamental frequency such as female vocals, select high.

Wide For more complex material that covers a broad frequency spectrum, select Wide. In Polyphonic mode, Wide is the default setting and is usually best for all material when using the Polyphonic audio type.



The range pop-up menu is unavailable in Rhythmic mode and Varispeed mode.

Gain

The Audio Gain control attenuates the input level to avoid clipping. Adjust the Gain control from 0.0 dB to -6.0 dB to avoid clipping in the processed signal.

Clip Indicator

The Clip indicator indicates clipping in the processed signal. When using time compression or pitch shifting above the original pitch, it is possible for clipping to occur. The Clip indicator lights when the processed signal is clipping. If the processed signal clips, undo the AudioSuite process and attenuate the input gain using the Gain control. Then, re-process the selection.

Level Indicator

The Level indicator displays the level of the output signal using a plasma LED, which uses the full range of plasma level metering colors.

Time Shift Time Controls

The Time section of Time Shift provides controls for specifying the amount of time compression or expansion as well as the timebase used for calculating TCE. Adjust the Time control to change the target duration for the processed audio.

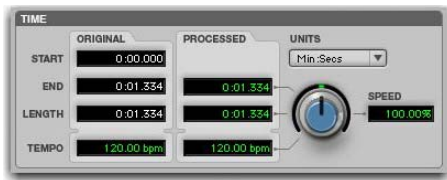

Time Shift, Time section

Original Displays the Start and End times, and Length of the edit selection. Times are displayed in units of the timebase selected in the Units pop-up menu.

Processed Displays the target End time and Length of the processed signal. Times are displayed in units of the timebase selected in the Units pop-up menu. You can click the Processed End and Length fields and type values. These values update automatically when adjusting the Time control.

Tempo Displays the Original Tempo and Processed Tempo in beats per minute (bpm). You can click the Original Tempo and Processed Tempo fields and type values. The Processed Tempo value updates automatically when adjusting the Time control.

Unit Select a timebase for the Original and Processed time fields: Bars|Beats, Min:Sec, Timecode, Feet+Frames, or Samples.

Speed Displays the target time compression or expansion as a percentage of the original. Adjust the Time control or click the Speed field and type a value. Time can be changed from 25.00% to 400.00% of the original speed (or 4 to 1/4 times the original duration). The default setting is 100.00%, or no change. 25.00% results in 4 times the original duration and 400.00% results in 1/4 of the original duration.

The Speed field only displays up to 2 decimal places, but lets you type in as many decimal places as you want (up to the IEEE standard). While the display rounds to 2 decimal places, the actual time shift is applied based on the number you typed. This is especially useful for typing post production pull up and pull down factors (see “Post Production Pull Up and Pull Down Tasks with Time Shift” on page 155).

Time Shift Formant Controls

The Formant section of Time Shift lets you shift the formant shape of the selected audio independently of the fundamental frequency. This is useful for achieving formant correct pitch shifting. It can also be used as an effect. For example, you can formant shift a male vocal up by five semitones and it will take on the characteristics of a female voice.

The Formant section is only available when Monophonic is selected as the Audio Type. The Formant section provides a single control for transposing the formants of the selected audio by -24.00 semitones (-2 octaves) to $+24.00$ semitones ($+2$ octaves), with fine resolution in cents. Adjust the Formant Shift control or click the Shift field and type a value.



Time Shift Formant section

About Formants

Audio with a fundamental pitch has an overtone series, or set of higher harmonics. The strength of these higher harmonics creates a formant shape, which is apparent if viewed using a spectrum analyzer. The overtone series, or harmonics, have the same spacing related to the pitch and have the same general shape regardless of what the fundamental pitch is. It is this formant shape that gives the audio its overall characteristic sound or timbre. When pitch shifting audio, the formant shape is shifted with the rest of the material, which can result in an unnatural sound. Keeping this shape constant is critical to formant-correct pitch shifting and achieving a natural sounding result.

Time Shift Transient Controls

The Transient section is only available when Polyphonic or Rhythmic is selected as the Audio Type, and provides slightly different controls for each.

When Polyphonic is selected as the Audio Type, the Transient section provides controls for setting the transient detection threshold and for adjusting the analysis window length for processing audio.



Time Shift Transient section with Polyphonic selected as the Audio Type

When Rhythmic is selected as the Audio Type, the Transient section provides controls for setting the transient detection threshold, and for adjusting the decay rate of the transients in the processed audio when time stretching.



Time Shift Transient section with Rhythmic selected as the Audio Type

Follow The follow button enables an envelope follower that simulates the original acoustics of the audio being stretched. Click the Follow button to enable or disable envelope following. Follow is only available when Polyphonic is selected as the Audio Type.

Threshold The Threshold controls sets the transient detection threshold from 0.0 dB to -40.0 dB. Disable transient detection by setting the Threshold control to Off (turn the knob all the way to the right). Part of Time Shift's processing relies upon separating "transient" parts of the selection from "non-transient" parts. Transient material tends to change its content quickly in time, as opposed to parts of the sound which are more sustained. Adjust the Threshold control or click the Threshold field and type a value.

The default value for Threshold is -6.0 dB. For highly percussive material, lower the threshold for better transient detection, especially with the Rhythmic audio setting. For less percussive material, and for shifting with the Polyphonic audio setting, a higher setting can yield better results. Experiment with this control, especially when shifting drums and percussive tracks, to achieve the best results.

Window The Window control sets the analysis window length for processing audio. You can set the Window from 6.0 milliseconds to 185.0 milliseconds. Adjust the Window control or click the Window field and type a value. The Window control is only available when Polyphonic is selected as the Audio Type.

The default for Window size is 18.0 milliseconds and works well for many applications, but you may want to try different Window settings to get the best results. Try larger window sizes for low frequency sounds or sounds that do not have many transients. Try smaller window sizes for drums and percussion. 37.0 milliseconds tends to work well for polyphonic instruments such as piano or guitar. A setting as large as 71.0 milliseconds works well for bass guitar. Settings in the 12 millisecond range work well on drums or percussion.

Decay Rate The Decay Rate control determines how much of the decay from a transient is heard in the processed audio when time stretching. When time stretching using the Rhythmic setting, the resulting gaps between the transients are filled in with audio, and Decay Rate determines how much of this audio is heard by applying a fade out rate. Decay Rate is only available when Rhythmic is selected as the Audio Type. Adjust the Decay Rate up to 100% to hear the audio that is filling the gaps created by the time stretching with only a slight fade, or adjust down to 1.0% to completely fade out between the original transients.

Time Shift Pitch Controls

The Pitch section of Time Shift provides controls for pitch shifting the selected audio. Use the Pitch control to transpose the pitch from -24.00 semitones (-2 octaves) to +24.00 semitones (+2 octaves), with fine resolution in cents.



Time Shift, Pitch section

Transpose Displays the transposition amount in semitones. You can transpose pitch from -24.00 semitones (-2 octaves) to +24.00 semitones (+2 octaves), with fine resolution in cents. Adjust the Pitch control or click the Transpose field and type a value.

Shift Displays the pitch shift amount as a percentage. You can pitch shift from 25.00% (-2 octaves) to +400.00% (+2 octaves). Adjust the Pitch control or click the Shift field and type a value. The default value is 100% (no pitch shift).

AudioSuite Input Modes and Time Shift

Time Shift supports the Pro Tools AudioSuite Input Mode selector for use on mono or multi-input processing.

Mono Mode Processes each audio clip as a mono file with no phase coherency maintained with any other simultaneously selected clips.

Multi-Input Mode Processes up to 48 input channels and maintains phase coherency within those selected channels.

AudioSuite Preview and Time Shift

Time Shift supports Pro Tools AudioSuite Preview and Bypass. For more information on using AudioSuite Preview and Bypass, see the *Pro Tools Reference Guide*.

Time Shift as AudioSuite TCE Plug-In Preference

The Time Shift plug-in's high quality time compression and expansion algorithms that can be used with the Pro Tools TCE Trim tool.

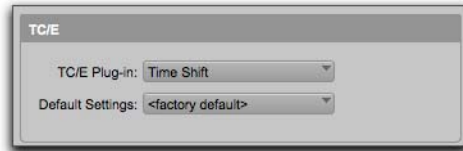

TCE Plug-In option in Processing Preferences page

 See the *Pro Tools Reference Guide* for more information about the TCE Trim tool.

To select Time Shift for use with the TCE Trim tool:

- 1 Choose Setup > Preferences.
- 2 Click the Processing tab.
- 3 From the TC/E Plug-In pop-up menu, select Time Shift.
- 4 Select a preset from the Default Settings pop-up menu.
- 5 Click OK.

Processing Audio Using Time Shift

Time Shift lets you change the time and pitch of selected audio independently or concurrently.

 *Normalizing a selection before using Time Shift may produce better results.*

Changing the Time Using Time Shift

To change the time of a selected audio clip:

- 1 Select AudioSuite > Pitch Shift > Time Shift.
- 2 Select the Audio Mode appropriate to the type of material you are processing (Monophonic, Polyphonic, or Rhythmic).
- 3 In Monophonic or Polyphonic mode, select the appropriate Range for the selected material (Low, Mid, High, or Wide).
- 4 If compressing the duration of the selection, attenuate the Gain control as necessary.
- 5 If using Monophonic mode, adjust the Formant Shift control.
- 6 If using Polyphonic or Rhythmic mode, adjust the Transient controls.
- 7 Make sure Pitch Shift is set to 100% (unless you also want to change the pitch of the selection).
- 8 Adjust the Time Shift control to set the amount of time change. Time change is measured in terms of the target duration using the selected timebase or as a percentage of the original.
- 9 Click Render.

Changing the Pitch Using Time Shift

To change the pitch of a selected audio clip:

- 1 Select AudioSuite > Pitch Shift > Time Shift.
- 2 Select the Audio Mode appropriate to the type of material you are processing (Monophonic, Polyphonic, or Rhythmic).
- 3 In Monophonic or Polyphonic mode, select the appropriate Range for the selected material (Low, Mid, High, or Wide).

- 4 If transposing the pitch of the selection up, attenuate the Gain control as necessary.
- 5 If using Monophonic mode, adjust the Formant Shift control.
- 6 If using Polyphonic or Rhythmic mode, adjust the Transient controls.
- 7 Make sure Time Shift is set to 0% (unless you also want to change the duration of the section).
- 8 Adjust the Pitch Shift control to set the amount of pitch change. Pitch change is measured in semitones (and cents) or as a percentage of the original.
- 9 Click Render.

Changing the Time and Pitch Using Time Shift

To change the time and pitch of a selected audio clip:

- 1 Select AudioSuite > Pitch Shift > Time Shift.
- 2 Select Varispeed from the Audio Mode pop-up menu.
- 3 Adjust either the Time Shift or Pitch Shift control to set the amount of time and pitch change in terms of a percentage of the original.
- 4 Click Render.



Using the Monophonic, Polyphonic, or Rhythmic modes, you can adjust both the Time Shift and Pitch Shift controls independently before processing.

Post Production Pull Up and Pull Down Tasks with Time Shift

The table below provides information on TCE settings for common post production tasks. Type the corresponding TCE% (represented to 10 decimal places in the table) in the Time Shift field for the corresponding post production task and the process the selected audio.

Pull Up or Pull Down	TCE% (to 10 Decimal Places)	Frames
Pal to Film -4%.tfx	96.0%	25 to 24/30
PAL to NTSC -4.1%.tfx	95.9040959041%	25 to 23.976/29.97
Film to PAL +4.1667%.tfx	+104.1666666667%	24/30 to 25
Film to NTSC -0.1%.tfx	99.9000999001%	24/30 to 23.976/29.97
NTSC to Pal +4.2667%.tfx	+104.2708333333%	23.976/29.97 to 25
NTSC to Film +0.1%.tfx	+100.10%	23.976/29.97 to 24/30

Chapter 26: Vari-Fi

Vari-Fi is an AudioSuite plug-in that provides a pitch-change effect similar to a tape deck or record turntable speeding up from or slowing down to a complete stop. Vari-Fi preserves the original duration of the audio selection.

Vari-Fi provides a pitch-change effect similar to a tape deck or record turntable speeding up from or slowing down to a complete stop. Features include:

- Speed up from a complete stop to normal speed
- Slow down to a complete stop from normal speed



Vari-Fi

Vari-Fi Controls

Change Controls

Slow Down

When selected, Slow Down applies a pitch-change effect to the selected audio, similar to a tape recorder or record turntable slowing down to a complete stop.

Speed Up

When selected, Speed Up applies a pitch-change effect to the selected audio, similar to a tape recorder or record turntable speeding up from a complete stop. This effect does not change the duration of the audio selection.

Selection Controls

The Selection setting determines the duration of the rendered clip in relation to the processing.

Fit To

When the Fit To option is selected, the length of the audio selection is retained when rendering the AudioSuite effect. This is useful for rendering the effect in place (especially if the selection is constrained by the grid or by adjacent clips).

When this option is enabled, processing is applied to only two-thirds of the selection so that the resultant rendering maintains the original duration of the selection.

Extend

When the **Extend** option is selected, all audio in the current Edit selection is processed and rendered. The resulting rendering is 150% the duration of the Edit selection. The selection start point does not change, but the rendered clip extends beyond the end of the Edit selection.

This can be useful if the last third (for speeding up) or the first third (for slowing down) of the Edit selection needs to be heard in the rendered effect.

Fades Controls

On

When the **On** option is selected, a fade-out is applied if the **Slow Down** option is selected or a fade in is applied if the **Speed Up** option is selected.

Off

When the **Off** option is selected, no fade-in or fade-out is applied in the rendered Edit selection.

This can result in a more pronounced “tape-stop” or “tape-start” effect and can also be useful for preserving the dynamic level at the end of the Edit selection when the **Slow Down** option is selected, or the beginning of the selection when the **Speed Up** option is selected.

Chapter 27: X-Form

X-Form is an AudioSuite plug-in that is based on the Radius algorithm from iZotope. X-Form provides the high quality time compression and expansion for music production, sound design, and audio loop applications. Use X-Form to manipulate audio loops for tempo matching or to change vocal tracks for formant correct pitch shifting. The X-Form plug-in is useful in audio post-production for adjusting audio to specific time or SMPTE durations for synchronization purposes. X-Form is also ideal for post-production pull up and pull down conversions.

 *Normalizing a selection before using X-Form may produce better results.*



X-Form

X-Form Displays and Controls Overview

The interface for X-Form is organized in four sections: Audio, Time, Transient, and Pitch.

Audio Use the controls in the Audio section to select the most appropriate time compression and expansion algorithm for the type of material you want to process and to attenuate the gain of the processed audio to avoid clipping.

Time Use the controls in the Time section to specify the amount of time compression or expansion you want to apply.

Transient Use the controls in the Transient section to adjust the transient detection for high quality time compression or expansion.

Pitch Use the controls in the Pitch section to apply pitch shifting. Pitch shifting can be formant correct with either the Polyphonic or Monophonic algorithm.

X-Form Audio Section Controls

The Audio section of X-Form provides controls for specifying the type of audio you want to process and gain attenuation of the processed signal to avoid clipping.



X-Form, Audio section

Type

The Audio Type determines the type of TCE and pitch shift algorithm for processing audio: Polyphonic, Monophonic, or Poly (Faster).

Polyphonic Use for processing complex sounds (such as a multipart musical selection).

! *When previewing Polyphonic, Poly (Faster) is used for faster previewing. However, when you process the audio selection, the high-quality Polyphonic setting is used.*

Monophonic Use for processing monophonic sounds (such as a vocal melody).

Poly (Faster) Use for faster previewing and processing, but with slightly reduced audio quality.

Gain

The Gain control attenuates the input level to avoid clipping. Adjust the Gain control from 0.0 dB to -6.0 dB to avoid clipping in the processed signal.

Clip Indicator The Clip indicator indicates clipping in the processed signal. When using time compression or pitch shifts above the original pitch, it is possible for clipping to occur. The Clip indicator lights when the processed signal is clipping. If the processed signal clips, undo the AudioSuite process and attenuate the input gain using the Gain control. Then, re-process the selection.

Level Indicator The Level indicator displays the level of the output signal using a plasma LED, which uses the full range of plasma level metering colors.

X-Form Time Section Controls

The Time section of X-Form provides controls for specifying the amount of time compression or expansion as well as the timebase used for calculating TCE. Adjust the Time control to change the target duration for the processed audio.



X-Form, Time section

Original

The Original column displays the Start and End times, and Length of the edit selection. Times are displayed in units of the timebase selected in the Units pop-up menu.

Processed

The Processed column displays the target End time and Length of the processed signal. Times are displayed in units of the timebase selected in the Units pop-up menu. You can click the Processed End and Length fields and type values. These values update automatically when adjusting the Time control.

Tempo

The Tempo row displays the Original Tempo and Processed Tempo in beats per minute (bpm). You can click the Original Tempo and Processed Tempo fields and type values. The Processed Tempo value updates automatically when adjusting the Time control.

Unit

Select a timebase for the Original and Processed time fields: Bars|Beats, Min:Sec, Timecode, Feet+Frames, or Samples.

Shift

The Shift setting displays the target time compression or expansion as a percentage of the original. Adjust the Time control or click the Shift field and type a value. Time can be shifted by as much as 12.50% to 800.00% of the original speed (or 8 times to 1/8 of the original duration) depending on which Range button is enabled (2x, 4x, or 8x).

The Shift field only displays up to 2 decimal places, but lets you type in as many decimal places as you want (up to the IEEE standard). While the display rounds to 2 decimal places, the actual time shift is applied based on the number you typed. This is especially useful for post-production pull up and pull down factors (see “Using X-Form for Post Production Pull Up and Pull Down Tasks” on page 164).

2x, 4x, and 8x Range Buttons

The 2x, 4x, and 8x Range buttons set the possible range for the Time Shift, Pitch Shift, and Formant Shift controls.

2x Lets you apply Time Shift, Pitch Shift, and Formant Shift from 50.00% to 200.00% (where 50.00% is 2 times the original duration and 200.00% is 1/2 of the original duration).

4x Lets you apply Time Shift, Pitch Shift, and Formant Shift from 25.00% to 400.00% (where 25.00% is 4 times the original duration and 400.00% is 1/4 of the original duration).

8x Lets you apply Time Shift, Pitch Shift, and Formant Shift from 12.50% to 800.00% (where 12.50% is 8 times the original duration and 800.00% is 1/8 of the original duration).

⚠ When changing to a smaller Range setting (such as switching from 8x to 2x), the Time Shift and Pitch Shift settings are constrained to the limits of the new, smaller range. For example, with 8x enabled and Time Shift set to 500%, switching to 2x changes the Time Shift value to 200%.

X-Form Transient Section Controls

The Transient section provides controls for setting the sensitivity for transient detection and for adjusting the analysis window size.



X-Form, Transient section

Sensitivity

The Sensitivity setting controls how X-Form determines and interprets transients from the original audio. Part of X-Form’s processing relies upon separating “transient” parts of the sample from “non-transient” parts. Transient material tends to change its content quickly in time, as opposed to parts of the sound which are more sustained. Sensitivity is only available when Polyphonic is selected as the Audio Type.

For highly percussive material, lower the Sensitivity for better transient detection, especially with the Rhythmic audio setting. For less percussive material, a higher setting can yield better results. Experiment with this control, especially when shifting drums and percussive tracks, to achieve the best results.

Window

The Window setting determines the analysis window size. You can adjust the Window from 10.0 milliseconds to 100.0 milliseconds. Adjust the Window control or click the Window field and type a value. Window is only available when Monophonic is selected as the Audio Type.

Try larger window sizes for low frequency sounds or sounds that do not have many transients. Try smaller window sizes for tuned drums and percussion. However, the default of 25 milliseconds should work well for most material.

X-Form Pitch Section Controls

The Pitch section provides controls for pitch shifting the selected audio. Use the Pitch control to transpose the pitch from as much as -36.00 semitones (-3 octaves) to $+36.00$ semitones ($+3$ octaves), with fine resolution in cents, depending on which Range button is enabled (2x, 4x, or 8x). X-Form also lets you transpose the formant shape independently of the fundamental frequency.



X-Form, Pitch section

Transpose

The Transpose setting displays the transposition amount in semitones. You can transpose pitch by as much as -36.00 semitones (-3 octaves) to $+36.00$ semitones ($+3$ octaves), with fine resolution in cents, depending on which Range button is enabled. Adjust the Pitch control or click the Transpose field and type a value.

Shift

The Shift setting displays the pitch shift amount as a percentage. Pitch can be shifted by as much as 12.50% (-3 octaves) to 800.00% ($+3$ octaves) depending on which Range button is enabled (2x, 4x, or 8x). Adjust the Pitch control or click the Shift field and type a value.

Formant

Audio with a fundamental pitch has an overtone series, or set of higher harmonics. The strength of these higher harmonics creates a formant shape, which is apparent if viewed using a spectrum analyzer. The overtone series, or harmonics, have the same spacing related to the pitch and have the same general shape regardless of what the fundamental pitch is. It is this formant shape that gives the audio its overall characteristic sound or timbre. When pitch shifting audio, the formant shape is shifted with the rest of the material, which can result in an unnatural sound. Keeping this shape constant is critical to formant correct pitch shifting and achieving a natural sounding result.

The Pitch section of X-Form lets you pitch shift the formants of the selected audio independently of the fundamental frequency. This is useful for achieving formant correct pitch shifting. It can also be used as an effect. For example, you can formant shift a male vocal up by five semitones and it will take on the characteristics of a female voice.

To enable or disable formant shifting:

- Click the In button. The In button lights when formant shifting is enabled.

The Formant field displays the amount of formant pitch shifting from -36.00 semitones (-3 octaves) to $+36.00$ semitones ($+3$ octaves), with fine resolution in cents. Adjust the Formant control or click the Formant field and type a value.

X-Form AudioSuite Input Modes

X-Form supports the Pro Tools AudioSuite Input Mode selector for use on mono or multi-input processing.

Mono Mode Processes each audio clip as a mono file with no phase coherency maintained with any other simultaneously selected clips.

Multi-Input Mode Processes up to 48 input channels and maintains phase coherency within those selected channels.

AudioSuite Preview

X-Form supports Pro Tools AudioSuite Preview and Bypass. For more information on using AudioSuite Preview and Bypass, see the *Pro Tools Reference Guide*.

AudioSuite TCE Plug-In Preference

The high quality time compression and expansion algorithms of X-Form can be used with the Pro Tools TCE Trim tool.



TCE Plug-In option in Processing Preferences page

⚠ *When using X-Form for the TCE Trim tool, the default 2x Range is used for an edit range of twice to half the duration of the original audio. If you select a Default Setting that uses either the 4x or 8x Range, the Time Shift and Pitch Shift setting are constrained to the 2x Range limit of 50% to 200%.*

 *Refer to the Pro Tools Reference Guide for more information about the TCE Trim tool.*

To select X-Form for use with the TCE Trim tool:

- 1 Choose Setup > Preferences.
- 2 Click the Processing tab.
- 3 From the TC/E Plug-In pop-up menu, select Avid X-Form.
- 4 Select a preset from the Default Settings pop-up menu.
- 5 Click OK.

Processing Audio Using X-Form

X-Form lets you change the time and pitch of selected audio independently or concurrently.



You can adjust both the Time Shift and Pitch Shift controls independently before processing.

To change the time of a selected audio clip:

- 1 Select AudioSuite > Pitch Shift > X-Form.
- 2 Select the Audio Type appropriate to the type of material you are processing (Monophonic or Polyphonic).
- 3 If compressing the duration of the selection, attenuate the Gain control as necessary.
- 4 Adjust the Transient controls.
- 5 Enable a Range button (2x, 4x, or 8x) to set the possible range for time change.
- 6 Adjust the Time Shift control to set the amount of time change. Time change is measured in terms of the target duration using the selected timebase or as a percentage of the original speed.
- 7 Click Render.

To change the pitch of a selected audio clip:

- 1 Select AudioSuite > Pitch Shift > X-Form.
- 2 Select the Audio Type appropriate to the type of material you are processing (Monophonic or Polyphonic).
- 3 If transposing the pitch of the selection up, attenuate the Gain control as necessary.
- 4 Adjust the Transient controls.
- 5 Enable a Range button (2x, 4x, or 8x) to set the possible range for pitch change.
- 6 Adjust the Pitch Shift control to set the amount of pitch change. Pitch change is measured in semitones (and cents) or as a percentage of the original pitch.
- 7 If you want to enable formant processing, click the IN button to enable Formant and adjust the Formant control.
- 8 Click Render.

Using X-Form for Post Production Pull Up and Pull Down Tasks

The table below provides information on TCE settings for common post-production tasks. Type the corresponding TCE% (represented to 10 decimal places in the following table) in the X-Form Time Shift field for the corresponding post-production task and the process the selected audio.



Use the X-Form Plug-In Settings for the corresponding post-production task.

Pull up or Pull Down	TCE% (to 10 Decimal Places)	Frames
Pal to Film -4%.tfx	96.0%	25 to 24/30
PAL to NTSC -4.1%.tfx	95.9040959041%	25 to 23.976/29.97
Film to PAL +4.1667%.tfx	+104.1666666667%	24/30 to 25
Film to NTSC -0.1%.tfx	99.9000999001%	24/30 to 23.976/29.97
NTSC to Pal +4.2667%.tfx	+104.2708333333%	23.976/29.97 to 25
NTSC to Film +0.1%.tfx	+100.10%	23.976/29.97 to 24/30

Part V: Reverb Plug-Ins

Chapter 28: D-Verb

D-Verb is a studio-quality reverb plug-in that is available in DSP, Native, and AudioSuite formats.

D-Verb supports 44.1 kHz, 48 kHz, 88.2 kHz, 96 kHz, 176.4 kHz and 192 kHz sample rates.

D-Verb operates as a mono, multi-mono, mono-to-stereo, or stereo plug-in.



D-Verb

D-Verb Controls

D-Verb provides a variety of controls for adjusting plug-in parameters.

Input Level Meters

Input meters indicate the input levels of the dry audio source signal.

An internal clipping LED will light if the reverb is overloaded. This can occur even when the input levels are relatively low if there is excessive feedback in the delay portion of the reverb. To clear the Clip LED, click it.

Output Level Meter

Output meters indicate the output levels of the processed signal.

Gain and Input Level Controls

D-Verb provides a Gain control above the Input Level meter to let you adjust the input gain.

Mix Control

The Mix slider adjusts the balance between the dry signal and the effected signal, giving you control over the depth of the effect. This control is adjustable from 100% to 0%.

Algorithm Control

This control selects one of seven reverb algorithms: Hall, Church, Plate, Room 1, Room 2, Ambient, or Non-linear. Selecting an algorithm changes the preset provided for it. Switching the Size setting changes characteristics of the algorithm that are not altered by adjusting the decay time and other user-adjustable controls. Each of the seven algorithms has a distinctly different character:

Hall A good general purpose concert hall with a natural character. It is useful over a large range of size and decay times and with a wide range of program material. Setting Decay to its maximum value will produce infinite reverberation.

Church A dense, diffuse space simulating a church or cathedral with a long decay time, high diffusion, and some pre-delay.

Plate Simulates the acoustic character of a metal plate-based reverb. This type of reverb typically has high initial diffusion and a relatively bright sound, making it particularly good for certain percussive signals and vocal processing. Plate reverb has the general effect of thickening the initial sound itself.

Room 1 A medium-sized, natural, rich-sounding room that can be effectively varied in size between very small and large, with good results.

Room 2 A smaller, brighter reverberant characteristic than Room 1, with a useful adjustment range that extends to “very small.”

Ambient A transparent response that is useful for adding a sense of space without adding a lot of depth or density. Extreme settings can create interesting results.

Nonlinear Produces a reverberation with a natural buildup and an abrupt cutoff similar to a gate. This unnatural decay characteristic is particularly useful on percussion, since it can add an aggressive characteristic to sounds with strong attacks.

Size Control

The Size control, in conjunction with the Algorithm control, adjusts the overall size of the reverberant space. There are three sizes: Small, Medium, and Large. The character of the reverberation changes with each of these settings (as does the relative value of the Decay setting). The Size buttons can be used to vary the range of a reverb from large to small. Generally, you should select an algorithm first, and then choose the size that approximates the size of the acoustic space that you are trying to create.

Diffusion Control

Diffusion sets the degree to which initial echo density increases over time. High settings result in high initial build-up of echo density. Low settings cause low initial buildup. This control interacts with the Size and Decay controls to affect the overall reverb density. High settings of diffusion can be used to enhance percussion. Use low or moderate settings for clearer and more natural-sounding vocals and mixes.

Decay Control

Decay controls the rate at which the reverb decays after the original direct signal stops. The value of the Decay setting is affected by the Size and Algorithm controls. This control can be set to infinity on most algorithms for infinite reverb times.

Pre-Delay Control

Pre-Delay determines the amount of time that elapses between the original audio event and the onset of reverberation. Under natural conditions, the amount of pre-delay depends on the size and construction of the acoustic space, and the relative position of the sound source and the listener. Pre-Delay attempts to duplicate this phenomenon and is used to create a sense of distance and volume within an acoustic space. Long Pre-Delay settings place the reverberant field behind rather than on top of the original audio signal.

Hi Frequency Cut

Hi Frequency Cut controls the decay characteristic of the high frequency components of the reverb. It acts in conjunction with the Low Pass Filter control to create the overall high frequency contour of the reverb. When set relatively low, high frequencies decay more quickly than low frequencies, simulating the effect of air absorption in a hall. The maximum value of this control is Off (which effectively means bypass).

Low Pass Filter

Low Pass Filter controls the overall high frequency content of the reverb by setting the frequency above which a 6 dB per octave filter attenuates the processed signal. The maximum value of this control is Off (which effectively means bypass).

Selections for D-Verb AudioSuite Processing

Because AudioSuite D-Verb adds additional material (the delayed audio) to the end of selected audio, make a selection that is longer than the original source material to allow the additional delayed audio to be written to the end of the audio file.

If you select only the original material without leaving additional space at the end, delayed audio that occurs after the end of the selection to be cut off.

Chapter 29: Reverb One

Reverb One is a world-class reverb processing plug-in that provides the highest level of professional sonic quality and reverb-shaping control. A set of unique, easy-to-use audio shaping tools lets you customize reverb character and ambience to create natural-sounding halls, vintage plates, or virtually any type of reverberant space you can imagine.

Reverb One is available in DSP, Native, and AudioSuite formats.



Reverb One

Reverb One supports 44.1 kHz, 48 kHz, 88.2 kHz, 96 kHz, 176.4 kHz and 192 kHz sample rates.

Reverb One operates as a mono, multi-mono, mono-to-stereo, or stereo plug-in.

Reverb One features include:

- Editable Reverb EQ graph
- Editable Reverb Color graph
- Reverb Contour graph
- Dynamic control of reverb decay
- Chorusing
- Early reflection presets
- Extensive library of reverb presets

About Reverb

Digital reverberation processing can simulate the complex natural reflections and echoes that occur after a sound has been produced, imparting a sense of space and depth—the signature of an acoustic environment. When you use a reverberation plug-in such as Reverb One, you are artificially creating a sound space with a specific acoustic character.

This character can be melded with audio material, with the end result being an adjustable mix of the original dry source and the reverberant wet signal. Reverberation can take relatively lifeless mono source material and create a stereo acoustic environment that gives the source a perceived weight and depth in a mix.

Creating Unique Sounds

In addition, digital signal processing can be used creatively to produce reverberation characteristics that do not exist in nature. There are no rules that need to be followed to produce interesting treatments. Experimentation can often produce striking new sounds.

Acoustic Environments

When you hear live sound in an acoustic environment, you generally hear much more than just the direct sound from the source. In fact, sound in an anechoic chamber, devoid of an acoustic space's character, can sound harsh and unnatural.

Each real-world acoustical environment, from a closet to a cathedral, has its own unique acoustical character or sonic signature. When the reflections and reverberation produced by a space combine with the source sound, we say that the space is *excited* by the source. Depending on the acoustic environment, this could produce the warm sonic characteristics we associate with reverberation, or it could produce echoes or other unusual sonic characteristics.

Reverb Character

The character of a reverberation depends on a number of things. These include proximity to the sound source, the shape of the space, the absorptivity of the construction material, and the position of the listener.

Reflected Sound

In a typical concert hall, sound reaches the listener shortly after it is produced. The original direct sound is followed by reflections from the ceiling or walls. Reflections that arrive within 50 to 80 milliseconds of the direct sound are called *early reflections*. Subsequent reflections are called *late reverberation*. Early reflections provide a sense of depth and strengthen the perception of loudness and clarity. The delay time between the arrival of the direct sound and the beginning of early reflections is called the *pre-delay*.

The loudness of later reflections combined with a large pre-delay can contribute to the perception of largeness of an acoustical space. Early reflections are followed by reverberation and repetitive reflections and attenuation of the original sound reflected from walls, ceilings, floors, and other objects. This sound provides a sense of depth or size.

Reverb One provides control over these reverberation elements so that you can create extremely natural-sounding reverb effects.

Reverb One Controls

Reverb One has a variety of controls for producing a wide range of reverb effects. Controls can be adjusted by dragging their sliders or typing values directly in their text boxes.

The harmonic spectrum of the reverb can also be adjusted on the graph displays. See “Reverb One Graphs” on page 175.

Reverb One Master Mix Controls

The Master Mix section has controls for adjusting the relative levels of the source signal and the reverb effect, and also the width of the reverb effect in the stereo field.

Wet/Dry

Adjusts the mix between the dry, unprocessed signal and the reverb effect.

Stereo Width

Controls the width of the reverb in the stereo field. A setting of 0% produces a mono reverb. A setting of 100% produces maximum spread in the stereo field.

100% Wet

Toggles the Wet/Dry control between 100% wet and the current setting.

Reverb One Dynamics Controls

The Dynamics section has controls for adjusting Reverb One’s response to changes in input signal level.

Dynamics can be used to modify a reverb’s decay character, making it sound more natural, or conversely, more unnatural, depending on the desired effect.

Typically, dynamics are used to give a reverb a shorter decay time when the input signal is above the threshold, and a longer decay time when the input level drops below the threshold.

This produces a longer, more lush reverb tail and greater ambience between pauses in the source audio, and a shorter, clearer reverb tail in sections without pauses.

For example, on a vocal track, use Dynamics to make the reverb effect tight, clear, and intelligible during busy sections of the vocal (where the signal is above the Threshold setting), and then “bloom” or lengthen at the end of a phrase (where the signal falls below the threshold).

Similarly, Dynamics can be used on drum tracks to mimic classic gated reverb effects by causing the decay time to cut off quickly when the input level is below the threshold.



To hear examples of decay dynamics, load one of the Dynamics presets using the Plug-In Librarian menu.

Decay Ratio

Controls the ratio by which reverb time is increased when a signal is above or below the Threshold level. Dynamics behavior differs when the Decay Ratio is set above or below 1. A ratio setting of greater than 1 increases reverb time when the signal is *above* the threshold. A ratio setting of less than 1 increases a reverb's time when the signal is *below* the threshold.

For example, if Decay Ratio is set to 4, the reverb time is increased by a factor of 4 when the signal is above the threshold level. If the ratio is 0.25, reverb time is increased by a factor of 4 when the signal is below the Threshold level.

Threshold

Sets the input level above or below which reverb decay time will be modified.

Chorus Controls

The Chorus section has controls for setting the depth and rate of chorusing applied to a reverb tail. Chorusing thickens and animates sounds by adding a delayed, pitch-modulated copy of an audio signal to itself.

Chorusing produces a more ethereal or spacey reverb character. It is often used for creative effect rather than to simulate a realistic acoustic environment.



To hear examples of reverb tail chorusing, load one of the Chorus presets using the Plug-In Librarian menu.

Depth

Controls the amplitude of the sine wave generated by the LFO (low frequency oscillator) and the intensity of the chorusing. The higher the setting, the more intense the modulation.

Rate

Controls pitch modulation frequency. The higher the setting, the more rapid the chorusing. Setting the Rate above 20 Hz can cause frequency modulation to occur. This will add side-band harmonics and change the reverb's tone color, producing some very interesting special effects.

Reverb One Reverb Section Controls

The Reverb section has controls for the various reverb tail elements, including level, time, attack, spread, size, diffusion, and pre-delay. These determine the overall character of the reverb.

Level

Controls the output level of the reverb tail. When set to 0%, the reverb effect consists entirely of the early reflections (if enabled).

Time

Controls the rate at which the reverberation decays after the original direct signal stops. The value of the Time setting is affected by the Size setting. You should adjust the reverb Size setting before adjusting the Time setting. If you set Time to its maximum value, infinite reverberation is produced. The HF Damping and Reverb Color controls also affect reverb Time.

Attack

Attack determines the contour of the reverberation envelope. At low Attack settings, reverberation builds explosively, and decays quickly. As Attack value is increased, reverberation builds up more slowly and sustains for the length of time determined by the Spread setting.

When Attack is set to 50%, the reverberation envelope emulates a large concert hall (provided the Spread and Size controls are set high enough).

Spread

Controls the rate at which reverberation builds up. Spread works in conjunctions with the Attack control to determine the initial contour and overall ambience of the reverberation envelope.

Low Spread settings result in a rapid onset of reverberation at the beginning of the envelope. Higher settings lengthen both the attack and buildup stages of the initial reverb contour.

Size Determines the rate of diffusion buildup and acts as a master control for Time and Spread within the reverberant space.

Size values are given in meters and can be used to approximate the size of the acoustic space you want to simulate. When considering size, keep in mind that the size of a reverberant space in meters is roughly equal to its longest dimension.

Diffusion Controls the degree to which initial echo density increases over time. High Diffusion settings result in high initial buildup of echo density. Low Diffusion settings cause low initial buildup.

After the initial echo buildup, Diffusion continues to change by interacting with the Size control and affecting the overall reverb density. Use high Diffusion settings to enhance percussion. Use low or moderate settings for clearer, more natural-sounding vocals and mixes.

Pre-Delay Determines the amount of time that elapses between the original audio event and the onset of reverberation. Under natural conditions, the amount of Pre-delay depends on the size and construction of the acoustic space, and the relative position of the sound source and the listener. Pre-delay attempts to duplicate this phenomenon and is used to create a sense of distance and volume within an acoustic space. Long Pre-Delay settings place the reverberant field behind rather than on top of the original audio signal.



For an interesting musical effect, set the Pre-Delay time to a beat interval such as 1/8, 1/16, or 1/32 notes.

Reverb One Early Reflection Controls

The Early Reflections section has controls for the various early reflection elements, including ER setting, level, spread, and delay.

Calculating Early Reflections

A particular reflection within a reverberant field is usually categorized as an early reflection. Early reflections are usually calculated by measuring the reflection paths from source to listener. Early reflections typically reach the listener within 80 milliseconds of the initial audio event, depending on the proximity of reflecting surfaces.

Simulating Early Reflections

Different physical environments have different early reflection signatures that our ears and brain use to pinpoint location information. These reflections influence our perception of the size of a space and where an audio source sits within it. Changing early reflection characteristics changes the perceived location of the reflecting surfaces surrounding the audio source.

This is commonly accomplished in digital reverberation simulations by using multiple delay taps at different levels that occur in different positions in the stereo spectrum (through panning). Long reverberation generally occurs after early reflections dissipate.

Reverb One provides a variety of early reflections models. These let you quickly choose a basic acoustic environment, then tailor other reverb characteristics to meet your precise needs.

ER Settings

Selects an early reflection preset. These range from realistic rooms to unusual reflective effects. The last five presets (Plate, Build, Spread, Slapback and Echo) feature a nonlinear response.

Early reflection presets include:

- **Room:** Simulates the center of a small room without many reflections.
- **Club:** Simulates a small, clear, natural-sounding club ambience.
- **Stage:** Simulates a stage in a medium-sized hall.
- **Theater:** Simulates a bright, medium-sized hall.
- **Garage:** Simulates an underground parking garage.
- **Studio:** Simulates a large, live, empty room.
- **Hall:** Places the sound in the middle of a hall with reflective, hard, bright walls.
- **Soft:** Simulates the space and ambience of a large concert hall.
- **Church:** Simulates a medium-sized space with natural, clear-sounding reflections.
- **Cathedral:** Simulates a large space with long, smooth reflections.
- **Arena:** Simulates a big, natural-sounding empty space.
- **Plate:** Simulates a hard, bright reflection. Use the Spread control to adjust plate size.
- **Build:** A nonlinear series of reflections
- **Spread:** Simulates a wide indoor space with highly reflective walls.
- **Slapback:** Simulates a large space with a long-delayed reflection.
- **Echo:** Simulates a large space with hard, unnatural echoes. Good for dense reverb.

Level

Controls the output level of the early reflections. Turning the Early Reflections Level slider completely off produces a reverb made entirely of reverb tail.

Spread

Globally adjusts the delay characteristics of the early reflections, moving them closer together or farther apart. Use Spread to vary the size and character of an early reflection preset. Setting the Plate preset to a Spread value of 50%, for example, will change the reverb from a large, smooth plate to a small, tight plate.

Delay Master

Determines the amount of time that elapses between the original audio event and the onset of early reflections.

Early Reflect On

Toggles early reflections on or off. When early reflections are off, the reverb consists entirely of reverb tail.

Reverb One Graphs

The reverb graphs display information about the tonal spectrum and envelope contour of the reverb. The Reverb EQ and Reverb Color graphs provide graphic editing tools for shaping the harmonic spectrum of the reverb.



Reverb One EQ graph controls

Editing Graph Values

In addition to the standard slider controls, the Reverb EQ and Reverb Color graph settings can be adjusted by dragging elements of the graph display.

To select the EQ or Color graph for editing:

- Select the EQ icon or the Color icon.



Reverb One (AAX version), EQ icon selected

To cut or boost a particular band:

- Drag a Band Cut/Boost breakpoint up or down.

To adjust frequency or crossover:

- Drag a Frequency/Crossover slider right or left.

To adjust high-frequency cut or damp:

- Drag the HF Cut/HF Damp control point right or left.

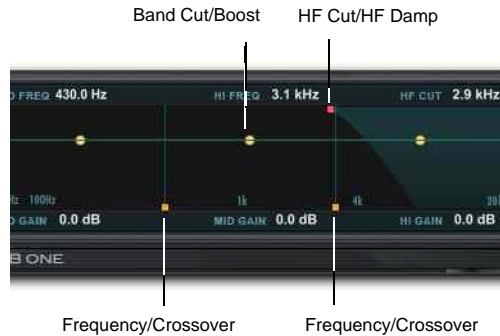

Adjusting graph controls

Reverb EQ Graph

You can use this 3-band equalizer to shape the tonal spectrum of the reverb. The EQ is post-reverb and affects both the reverb tail and the early reflections.

Frequency Sliders Sets the frequency boundaries between the low, mid, and high band ranges of the EQ.

The low frequency slider (60.0 Hz–22.5 kHz) sets the frequency boundary between low and mid cut/boost points in the EQ.

The high-frequency slider (64.0 Hz–24.0 kHz) sets the frequency boundary between the mid and high cut/boost points in the EQ.

Band Breakpoints Control cut and boost values for the low, mid, and high frequencies of the EQ. To cut a frequency band, drag a breakpoint downward. To boost, drag upward. The adjustable range is from –24.0 dB to 12.0 dB.

HF Cut Breakpoint Sets the frequency above which a 6 dB/octave low pass filter attenuates the processed signal. It removes both early reflections and reverb tails, affecting the overall high-frequency content of the reverb. Use the HF Cut control to roll off high frequencies and create more natural-sounding reverberation. The adjustable range is from 120.0 Hz to 24.0 kHz.

Reverb Color Graph

You can use the Reverb Color graph to shape the tonal spectrum of the reverb by controlling the decay times of the different frequency bands. Low and high crossover points define the cut and boost points of three frequency ranges.

For best results, set crossover points at least two octaves higher than the frequency you want to boost or cut. For example, to boost a signal at 100 Hz, set the crossover to 400 Hz.

Set the crossover to 500 Hz to boost low frequencies most effectively. Set it to 1.5 kHz to cut low frequencies most effectively.

Crossover Sliders Sets the frequency boundaries between the low, mid, and high frequency ranges of the reverberation filter.

The low-frequency slider sets the crossover frequency between low and mid frequencies in the reverberation filter. The adjustable range is from 60.0 Hz to 22.5 kHz.

The high-frequency slider sets the crossover frequency between mid and high frequencies in the reverberation filter. The adjustable range is from 64.0 Hz to 24.0 kHz.

Band Breakpoints Controls cut and boost ratios for the decay times of the low, mid, and high-frequency bands of the reverberation filter. To cut a frequency band, drag a breakpoint downward. To boost, drag it upward. The adjustable range is from 1:8 to 8:1.

HF Damp Breakpoint Sets the frequency above which sounds decay at a progressively faster rate. This determines the decay characteristic of the high-frequency components of the reverb.

HF Damp works in conjunction with HF Cut to shape the overall high-frequency contour of the reverb. HF Damp filters the entire reverb with the exception of the early reflections. At low settings, high frequencies decay more quickly than low frequencies, simulating the effect of air absorption in a hall. The adjustable range is from 120.0 Hz to 24.0 kHz.

Reverb Contour Graph

The Reverb Contour graph displays the envelope of the reverb, as determined by the early reflections and reverb tail.



Reverb Contour graph (AAX version)

ER and RC Buttons Toggles the display mode. Selecting ER (early reflections) displays early reflections data in the graph. Selecting RC (reverb contour) displays the initial reverberation envelope in the graph. Early Reflections and Reverb Contour can be displayed simultaneously.

Other Reverb One Controls

In addition to its reverb-shaping controls, Reverb One also features online help and level metering.

Tool Tips

To use tool tips, move the cursor over the name of any control, and an explanation appears as a tool tip.

Input Level Meters

Input meters indicate the input levels of the dry audio source signal. Output meters indicate the output levels of the processed signal.

An internal clipping LED will light if the reverb is overloaded. This can occur even when the input levels are relatively low if there is excessive feedback in the delay portion of the reverb. To clear the Clip LED, click it.

Chapter 30: ReVibe II

ReVibe II is a studio-quality reverb and acoustic environment modeling plug-in available in DSP, Native, and AudioSuite formats.



ReVibe II

Using ReVibe II

ReVibe II makes it possible to model extremely realistic acoustic spaces and place audio elements within a mix.

ReVibe II supports 44.1 kHz, 48 kHz, 88.2 kHz, 96 kHz, 176.4 kHz and 192 kHz sample rates.

ReVibe II works with mono and stereo formats, and LCR, LCRS, quad, 5.0, and 5.1 greater-than-stereo multichannel formats.

! *Greater-than-stereo formats are only available with Pro Tools HD.*

In general, when working with stereo and greater-than-stereo tracks, use the multichannel version of ReVibe II.

ReVibe II supports the following combinations of track types and plug-in insert formats:

Track Type	Plug-in Insert Format						
	Mono	Stereo	L C R	L C R S	Quad	5.0	5.1
Mono	•	•	•	•	•	•	•
Stereo		•	•	•	•	•	•
L C R			•	•	•	•	•
L C R S				•			
Quad					•		
5.0						•	
5.1							•

Dragging in the Graphic Display to Adjust Controls

In addition to dragging controls and typing control values, you can adjust settings on the Decay Color & EQ graphic displays by dragging control points on the graph.

To cut or boost a particular EQ band:

- Drag a control point up or down.



Cutting or boosting an EQ frequency band

To adjust EQ frequency crossover:

- Drag the control point right or left.



Setting the EQ crossover frequency

To adjust high frequency rear cut:

- Drag the control point right or left.



Setting the rear cut frequency

ReVibe II Input and Output Meters

The Input and Output meters indicate the input and output signal levels. These meters range from 0 dB to -96 dB. The number of input and output meters that operate simultaneously ranges from a single meter for mono input and output, up to five input and output meters for 5.0 and 5.1 multichannel processing. The number of meters displayed depends on the channel format of the track on which the plug-in is inserted.

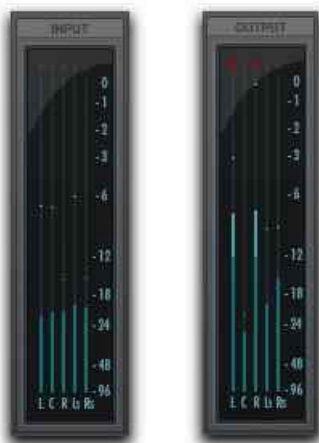

Input and Output meters (5.1)

Clip Indicators

A red channel clip indicator appears at the top of each meter. The clip indicator lights when the signal level exceeds 0 dB, and stays lit until cleared. Clicking a meter's clip indicator clears that meter.

ReVibe II Controls

ReVibe II has a variety of controls for producing a wide range of reverb effects. Controls can be adjusted by dragging their sliders, typing values directly in their text boxes, and adjusted on the Decay Color and EQ graph displays.

Room and Reverb Type

ReVibe II lets you select the type of Room and Reverb modeled. Each Room and Reverb type models early reflection characteristics for specific types of rooms or effects devices. Each Room and Reverb type also incorporates a complex room coloration EQ, which models the general frequency response of various rooms and effects devices.

Choosing a new Reverb Type changes the early reflections and room coloration EQ only. All of the other ReVibe II settings remain unchanged. To create a preset that includes all parameters, use the Plug-In Settings menu.

 For more information on saving and importing plug-in presets, see the *Pro Tools Reference Guide*.

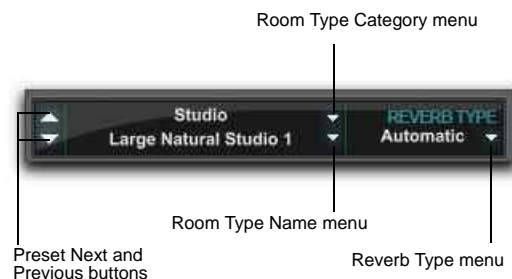

Reverb Type display and controls

The Reverb Type display shows the Room Type Category, Room Type Name, the Next and Previous buttons, and the Reverb Type.

Room Type Category Menu

Clicking on the Room Type Category menu lets you select one of the 14 Room Type categories, and selects the first Room Type preset in that category.

Room Type Name Menu

Click the Room Type Name menu to select from a list of all available Room Type presets.

 See “ReVibe II Room Types” on page 188 for a list of room presets.

Next and Previous Buttons

Click the Next or Previous buttons to choose the next or previous Room Type.

Reverb Type Menu

Click the Reverb Type menu to select the type of reverb tail. There are nine basic reverb types, plus Automatic. Select Automatic to use the reverb tail type that is stored with the currently selected room type. The reverb types are:

- *Automatic* selects the reverb tail type stored with the room type.
- *Natural* is an average reverb tail type with no extreme characteristics.
- *Smooth* is optimized for large rooms.
- *Fast Attack* can be useful for plate reverbs.
- *Dense* is similar to smooth, and can also be good for a plate reverb.
- *Tight* is good for small to medium rooms.
- *Sparse 1* produces sparse early reflections with a high diffusion buildup.
- *Sparse 2* can be useful for a spring reverb.
- *Wide* is a generic large reverb.
- *Small* is optimized for small rooms.

ReVibe II Reverb Section Controls

The Reverb section has controls for the various reverb tail elements, including level, time, size, spread, attack time, attack shape, rear shape, diffusion, and pre-delay. These determine the overall character of the reverb tail.

Size Control

The Size control adjusts the apparent size of the reverberant space from small to large. Set the Size control to approximate the size of the acoustic space you want to simulate. Size values are given in meters. The range of this control is from 2.0 m to 60.0 m (though relative size will change based on the current Room Type).

Higher Size settings increase both the Time and Spread values.

 *When specifying reverb size, keep in mind that the size of a reverberant space in meters is approximately equal to its longest dimension. In general, halls range from 25 m to 50 m; large to medium rooms range from 15 m to 30 m; and small rooms range from 5 m to 20 m. Similarly, a Room Size setting of 20m corresponds roughly to a 4x8 plate.*

Time Control

Time controls how long the reverberation continues after the original source signal stops. The range of this control is from 100.0 ms to Inf (infinity). Setting Time to its maximum value will produce infinite reverberation.

Level Control

Level controls the output level of the reverb tail. When set to $-\text{INF}$ (minus infinity) no reverb tail is heard, and the reverb effect consists entirely of the early reflections (if enabled). The range of this control is from $-\text{INF}$ to 6.0 dB.

Diffusion Control

Diffusion controls the rate that the sound density of the reverb tail increases over time. The control ranges between -50% and 50%. At 0%, diffusion is set to an optimal preset value. Positive Diffusion settings create a longer initial buildup of echo density. At negative settings, the buildup of echo density is slower than at the optimal preset value.

Spread Control

Spread controls the rate at which reverberation builds up. Spread works in conjunction with the Attack Shape control to determine the initial contour and overall ambience of the reverberation envelope.

At low Spread settings there is a rapid onset of reverb at the beginning of the reverberation envelope. Higher settings lengthen both the attack and buildup of the initial reverb contour. The range of this control is from 0% to 100%.

Pre-Delay Control

The Pre-Delay control in the Reverb section sets the amount of time that elapses between signal input and the onset of the reverb tail.

Under natural conditions, the amount of pre-delay depends on the size and construction of the acoustic space and the relative position of the sound source and the listener. Pre-delay attempts to duplicate this phenomenon and is used to create a sense of distance and volume within an acoustic space. Extremely long pre-delay settings produce effects that are unnatural but sonically interesting.

The range of this control is from 0.0 ms to 300.0 ms.

Attack Time Control

Attack Time adjusts the length of time between the start of the reverb tail and its peak level. Settings are Short, Medium, or Long.

Attack Shape Control

Attack Shape determines the contour of the attack portion of the reverberation envelope. At 0%, there is no buildup contour, and the reverb tail begins at its peak level. At a high Attack Shape setting the reverb tail begins at a relatively low initial level and ramps up to the peak reverb level. The range of this control is from 0% to 100%.

Rear Shape Control

Rear Shape adjusts the envelope of the reverb in the rear channels to control the length of the attack time. This gives more reverb presence and a longer reverb bloom in the rear channels. The range of this control is from 0% to 100%.

ReVibe II Early Reflection Section

Different physical environments have different early reflection signatures that our ears and brain use to pinpoint location information in physical space. These reflections influence our perception of the size of a space and where an audio source sits within it.

Changing early reflection characteristics changes the perceived location of the reflecting surfaces surrounding the audio source. In general, the reverb tail continues after early reflections dissipate.

ReVibe II room presets use multiple delay taps at different levels, different times, and in different positions in the multichannel environment (through 360° panning) to create extremely realistic sounding environments.

The Early Reflect section has controls for adjusting the various early reflection elements, including level, spread, and pre-delay.

Level Control

Level controls the output level of the early reflections. Setting the Level slider to $-\text{INF}$ (minus infinity) eliminates the early reflections from the reverb effect. The range of this control is from $-\text{INF}$ to 6.0 dB.

Spread Control

Spread globally adjusts the delay characteristics of the early reflections, moving the individual delay taps closer together or farther apart. Use Spread to vary the size and character of an early reflection preset. The range of this control is from -100% to 100% .

At 0% , the early reflections are set to their optimum value for the room preset. Typical spread values range between -25% and 25% .



Setting Spread to 100% produces widely spaced early reflections that may sound unnatural. At -100% the early reflections have no spread at all, and are heard as a single reflection.

Pre-Delay Control

The Pre-Delay control in the Early Reflect section determines the amount of time that elapses between the onset of the dry signal and the first early reflection delay tap. Some Room Types, such as those that produce slapback effects, have additional built-in pre-delay. The range of this control is from -300.0 ms to 300.0 ms.

Negative Pre-Delay times imply that some early reflection delay taps should sound before the original dry signal. Since this is not possible, any of the delay taps that would sound before the dry signal are not used and do not sound.

When Pre-Delay Link is enabled, negative early reflection Pre-Delay times can be used to make the early reflections start before the reverb tail.

Pre-Delay Link Button

The Early Reflections Pre-Delay Link button toggles linking of the Early Reflection Pre-Delay control and the Reverb Pre-Delay control. When linked, the Early Reflection Pre-Delay is offset by the Reverb Pre-Delay amount, so that the total delay for the early reflections is the sum of the Early Reflection Pre-Delay and the Reverb Pre-Delay.

Early Reflections On Button

This button toggles early reflections on or off. When early reflections are off, the reverb effect consists entirely of reverb tail.

ReVibe II Room Coloration Section Controls

The Room Coloration controls work in conjunction with the selected Room Type. Coloration takes the characteristic resonant frequencies or EQ traits of the room and allows you to apply this spectral shape to the reverb.

In addition to letting you adjust the overall sound of the room, the high-frequency and low-frequency components are split to allow you to emphasize or de-emphasize the low and high frequency response of the room.

Coloration Control

Coloration adjusts how much of the EQ characteristics of the selected Room Type are applied to the original signal. The range of this control is from 0% to 200% . A setting of 100% provides the optimum coloration for the room type. Settings above 100% will tend to produce extreme and unnatural coloration.

High Frequency Color Control

High Frequency Color (HF Color) adds or subtracts additional high frequency coloration, or relative brightness, to the acoustic model of the room. The range of this control is from -50.0% to 50.0% .

Low Frequency Color Control

Low Frequency Color adds or subtracts additional low frequency coloration, or relative darkness, to the acoustic model of the room. The range of this control is from -50.0% to 50.0% .

ReVibe II Levels Section Controls

The Levels section has controls for adjusting source input and ReVibe II output levels. ReVibe II provides individual output level controls for Front, Center, Rear reverb, and Rear early reflections.

In stereo and greater-than-stereo formats where there is no center channel or where there are no rear channels, the center and rear level controls can be used to augment the reverb sound. Reverb and early reflections that would be heard either from the center channel or from the rear channels can be mixed into the front left and right channels.

Input Control

Input adjusts the level of the source input to prevent internal clipping. The range of this control is from -24.0 dB to 0.0 dB. Lowering the Input control does not change the levels shown on the input side of the Input/Output meter, which shows the level of the signal before the Input control.

Front Control

Front controls the output level of the front left and right outputs. Front is also the main level control for stereo. The range of this control is from $-\text{INF}$ (minus infinity) to 0.0 dB.

Center Control

Center controls the output level of the center channel outputs of multichannel formats that have a center channel (such as LCR or 5.1).

When ReVibe II is used in a multichannel format that has no center channel (such as stereo or quad), the Center level control adjusts a phantom center channel signal that is center-panned to the front left and right outputs.

The range of this control is from $-\text{INF}$ (minus infinity) to 0.0 dB.

Rear Reverb Control

Rear controls the output level of the rear outputs of multichannel formats that have rear channels (such as quad or 5.1).

When ReVibe II is used in a multichannel format that has no rear channels (such as a stereo or LCR) the Rear level control instead adjusts rear channel signals hard-panned to the front left and right outputs.

The range of this control is from $-\text{INF}$ (minus infinity) to 0.0 dB.

Rear Early Reflections Control

Rear ER controls the output level of early reflections in the rear outputs. The range of this control is from $-\text{INF}$ (minus infinity) to 0.0 dB.



The Rear ER control has no effect when the early reflections are turned off with the ER On/Off button.

Rear Level Link Button

The Rear Level Link button toggles linking of the Rear Reverb and Rear Early Reflections controls on or off. The Rear Reverb and the Rear Early Reflections controls are linked by default. When linked, the Rear Early Reflections and Rear Reverb

controls move in tandem when either is adjusted. When unlinked, the Rear Early Reflections and the Rear Reverb controls can be adjusted independently.

ReVibe II Chorus Section Controls

The Chorus section has controls for adjusting the depth and rate of chorusing applied to the reverb tail. Chorusing thickens and animates sounds and produces a more ethereal reverb character. It is often used for creative effects rather than to simulate a realistic acoustic environment.

Depth Control

Depth controls the amplitude of the sine wave generated by the LFO (low frequency oscillator) and the intensity of the chorusing. The higher the setting, the more intense the modulation. The range of this control is from 0% to 100%.

Rate Control

Rate controls the frequency of the LFO. The higher the setting, the more rapid the chorusing. The range of this control is from 0.1 Hz to 30.0 Hz.

Setting the Rate above 20 Hz can cause frequency modulation to occur. This will add side-band harmonics and change the reverb's tone color, producing interesting effects. Typical settings are between 0.2 Hz and 1.0 Hz.

Chorus On Button

This button toggles the chorus effect on or off.

ReVibe II Mix Section Controls

The Mix section has controls for adjusting the relative levels of the source signal and the reverb effect.

Wet Control

The Wet control adjusts the mix between the dry, unprocessed signal and the reverb effect. If you insert the ReVibe II plug-in directly onto an audio track, settings from 30% to 60% are a good starting point for experimenting with this control. The range of this control is from 0% to 100%.



You can also achieve a 100% wet mix by clicking the 100% Wet Mix button.

Stereo Width Control

Stereo Width controls the stereo field spread of the front reverb channels. A setting of 0% produces a mono reverb, but leaves the panning of the original source signal unaffected. A setting of 100% produces a hard panned stereo image.

Settings above 100% use phase inversion to create an even wider stereo effect. The Stereo Width slider displays red above the 100% mark to remind you that a phase effect is being used to widen the stereo field.

The range of this control is from 0% to 150%. The default setting is 100%.



The Stereo Width control does not affect the reverberation effect coming through the rear channels. If you want to produce a strictly mono reverb, be sure to set the Rear Reverb setting (Levels section) to -INF dB.

100% Wet and Dry Mix Buttons

These buttons set the Wet control to 100% Wet or 100% Dry and the current setting. A 100% wet mix contains only the reverb effect with none of the direct signal. This setting can be useful when using pre-fader sends to achieve send/return bussing. The wet/dry balance in the mix can be controlled using the track faders for the dry signal, and the Auxiliary Input fader for the effect return.

ReVibe II Decay EQ Graph

The EQ display lets you adjust the Decay EQ settings for ReVibe II. Click the EQ button to toggle the display to show the Decay EQ settings. To adjust a setting on the graph, drag the corresponding control point.



EQ display

Each control point on the graph has corresponding text fields above and below the display that show the current values.

Low Frequency Control

The Lo Freq control sets the frequency boundary between low and mid cut or boost points in the reverb EQ. The range of this control is from 50.0 Hz to 1.5 kHz.

Low Gain Control

The Lo Gain control sets cut and boost values for the low and mid frequencies of the reverb decay EQ. The range of this control is from -24.0 dB to 12.0 dB.

High Frequency Control

The Hi Freq control sets the frequency boundary between mid and high cut or boost points in the reverb EQ. The range of this control is from 1.5 kHz to 20.0 kHz.

High Gain Control

The Hi Gain control sets cut and boost values for the mid and high frequencies of the reverb decay EQ. The range of this control is from -24.0 dB to 12.0 dB.

High Frequency Rear Cut Control

The Rear control rolls off additional high frequencies in the rear channels of the early reflections and reverb tail. The application of this filter is distinct from the application of Decay Color and Decay EQ. The range of this control is from 250.0 Hz to 20.0 kHz.

ReVibe II Decay Color Graph

The Color display lets you adjust the Decay Color settings for ReVibe II. Click the Color button to toggle the display to show Decay Color settings. To adjust a setting on the graph, drag the corresponding control point.



Color display

You can use the controls in the Decay Color graph to shape the tonal spectrum of the reverb by adjusting the decay times of the low and high frequency ranges. Low and high crossover points define the cut and boost points of three frequency ranges.

For best results, set crossover points at least one octave higher than the frequency you want to boost or cut. To boost a signal at 200 Hz, for example, set the crossover to 400 Hz.

Low Frequency Crossover Control

The Lo Crossover control sets the crossover frequency at which transitions from low frequencies to mid frequencies take place in the reverberation filter. The range of this control is from 50.0 Hz to 1.5 kHz.

Low Frequency Ratio Control

The Lo Ratio control sets cut or boost ratios for the decay times of the low and mid frequency bands of the reverberation filter. The range of this control is between 1:16.0 and 4.0:1.

High Frequency Crossover Control

The Hi Crossover control sets the crossover frequency at which transitions from mid frequencies to high frequencies take place in the reverberation filter. The range of this control is from 1.5 kHz to 20.0 kHz.

High Frequency Ratio Control

The Hi Ratio control sets cut or boost ratios for the decay times of the mid and high frequency bands of the reverberation filter. The range of this control is between 1:16.0 and 4.0:1.

ReVibe II Contour Display

The Contour display shows the current reverb shape and early reflections graphically. Both front and rear reverb tail shapes and early reflections can be viewed at the same time. Buttons below the display allow you to select the type of data being displayed.



Contour display

Early Reflections Button

The Early Reflections button toggles display of early reflections on or off within the Contour display. When the Early Reflections button is illuminated, early reflections data is displayed. When the Early Reflections button is not illuminated, early reflections data is not displayed. Both early reflections and reverb contour data can be displayed simultaneously.

Reverb Contour Button

The Reverb Contour button toggles display of the reverb contours for both the front and rear channels on or off within the Contour display. When the Reverb Contour button is illuminated, the reverberation envelopes are displayed. When the Reverb Contour button is not illuminated, the reverberation envelopes are not displayed. Both early reflections and reverb contour data can be displayed simultaneously.

Front Button

The Front button toggles display of the front channel reverb contour and the front channel early reflections on or off within the Contour display.

When the Front button is illuminated, the initial reverberation envelope and early reflections for the front channels are displayed. When the Front button is not illuminated, they are not displayed.

Rear Button

The Rear button toggles display of the rear channel reverb contour and the rear channel early reflections on or off within the Contour display. When the Rear button is illuminated, the initial reverberation envelope and early reflections for the rear channels are displayed. When the Rear button is not illuminated, they are not displayed.

ReVibe II Room Types

ReVibe II comes with over 200 built-in Room Type presets in 14 Room Type categories. These Room Type presets contain complex early reflections and room coloration characteristics that define the sound of the space. The Room Type categories and their presets are as follows:

Studios

- Large Natural Studio 1
- Large Natural Studio 2
- Large Live Room 1
- Large Live Room 2
- Large Dense Studio 1
- Large Dense Studio 2
- Medium Natural Studio 1
- Medium Natural Studio 2
- Medium Natural Studio 3
- Medium Natural Studio 4

- Medium Live Room 1
- Medium Live Room 2
- Medium Dense Studio 1
- Medium Dense Studio 2
- Small Natural Studio 1
- Small Natural Studio 2
- Small Natural Studio 3
- Small Natural Studio 4
- Small Natural Studio 5
- Small Dense Studio 1
- Small Dense Studio 2
- Vocal Booth 1
- Vocal Booth 2
- Vocal Booth 3
- Vocal Booth 4

Rooms

- Large Bright Room 1
- Large Bright Room 2
- Large Neutral Room 1
- Large Neutral Room 2
- Large Dark Room 1
- Large Dark Room 2
- Large Boomy Room
- Medium Bright Room 1
- Medium Bright Room 2
- Medium Bright Room 3
- Medium Neutral Room 1
- Medium Neutral Room 2
- Medium Neutral Room 3
- Medium Dark Room 1
- Medium Dark Room 2
- Medium Dark Room 3

- Small Bright Room 1
- Small Bright Room 2
- Small Bright Room 3
- Small Neutral Room 1
- Small Neutral Room 2
- Small Neutral Room 3
- Small Dark Room 1
- Small Dark Room 2
- Small Boomy Room

Halls

- Large Natural Hall 1
- Large Natural Hall 2
- Large Natural Hall 3
- Large Natural Hall 4
- Large Natural Hall 5
- Large Natural Hall 6
- Large Dense Hall
- Large Sparse Hall
- Medium Natural Hall 1
- Medium Natural Hall 2
- Medium Natural Hall 3
- Medium Natural Hall 4
- Medium Dense Hall
- Small Natural Hall 1
- Small Natural Hall 2

Theaters

- Large Theater 1
- Large Theater 2
- Medium Theater 1
- Medium Theater 2
- Small Theater 1

- Small Theater 2

Churches

- Large Natural Church 1
- Large Natural Church 2
- Large Dense Church
- Large Slap Church
- Medium Natural Church 1
- Medium Natural Church 2
- Medium Dense Church
- Small Natural Church 1
- Small Natural Church 2

Cathedrals

- Natural Cathedral 1
- Natural Cathedral 2
- Natural Cathedral 3
- Dense Cathedral 1
- Dense Cathedral 2
- Slap Cathedral

Plates

- Large Natural Plate
- Large Bright Plate
- Large Synthetic Plate
- Medium Natural Plate
- Medium Bright Plate
- Small Natural Plate
- Small Bright Plate

Springs

- Guitar Amp Spring 1
- Guitar Amp Spring 2
- Guitar Amp Spring 3

- Guitar Amp Spring 4
- Guitar Amp Spring 5
- Guitar Amp Spring 6
- Studio Spring 1
- Studio Spring 2
- Studio Spring 3
- Studio Spring 4
- Dense Spring 1
- Dense Spring 2
- Resonant Spring
- Funky Spring 1
- Funky Spring 2
- Funky Spring 3
- Funky Spring 4

Chambers

- Large Chamber 1
- Large Chamber 2
- Large Chamber 3
- Large Chamber 4
- Large Chamber 5
- Large Chamber 6
- Medium Chamber 1
- Medium Chamber 2
- Medium Chamber 3
- Medium Chamber 4
- Medium Chamber 5
- Small Chamber 1
- Small Chamber 2
- Small Chamber 3
- Small Chamber 4

Ambience

- Large Ambience 1
- Large Ambience 2
- Large Ambience 3
- Large Ambience 4
- Medium Ambience 1
- Medium Ambience 2
- Medium Ambience 3
- Medium Ambience 4
- Medium Ambience 5
- Small Ambience 1
- Small Ambience 2
- Small Ambience 3
- Very Small Ambience

Film and Post

- Medium Kitchen
- Small Kitchen
- Bathroom 1
- Bathroom 2
- Bathroom 3
- Bathroom 4
- Bathroom 5
- Shower Stall
- Hallway
- Closet
- Classroom 1
- Classroom 2
- Large Concrete Room
- Medium Concrete Room
- Locker Room
- Muffled Room
- Very Small Room 1

- Very Small Room 2
- Very Small Room 3
- Car 1
- Car 2
- Car 3
- Car 4
- Car 5
- Phone Booth
- Metal Garbage Can
- Drain Pipe
- Tin Can

Large Spaces

- Parking Garage 1
- Parking Garage 2
- Parking Garage 3
- Warehouse 1
- Warehouse 2
- Stairwell 1
- Stairwell 2
- Stairwell 3
- Stairwell 4
- Stairwell 5
- Gymnasium
- Auditorium
- Indoor Arena
- Stadium 1
- Stadium 2
- Tunnel

Vintage Digital

- Large Hall Digital
- Medium Hall Digital

- Large Room Digital
- Medium Room Digital
- Small Room Digital

Effects

- Mono Slapback 1
- Mono Slapback 2
- Mono Slapback 3
- Wide Slapback 1
- Wide Slapback 2
- Wide Slapback 3
- Multi Slapback 1
- Multi Slapback 2
- Multi Slapback 3
- Multi Slapback 4
- Spread Slapback 1
- Spread Slapback 2
- Mono Echo 1
- Mono Echo 2
- Mono Echo 3
- Wide Echo 1
- Wide Echo 2
- Multi Echo 1
- Multi Echo 2
- Prism
- Prism Reverse
- Inverse Long
- Inverse Medium
- Inverse Short
- Stereo Enhance 1
- Stereo Enhance 2
- Stereo Enhance 3

Chapter 31: Space

Space is an AAX format convolution reverb plug-in that is available in DSP, Native, and AudioSuite formats. Space was designed to be the ultimate reverb for music and post-production applications. By combining the sampled acoustics of real reverb spaces with advanced DSP algorithms, Space offers stunning realism with full control of reverb parameters in mono, stereo, and surround formats.

Space supports 44.1 kHz, 48 kHz, 88.2 kHz, and 96 kHz sample rates.

Space works with mono, stereo, and mono-to-stereo formats. With Pro Tools HD, Space also supports Quad, 5.0, mono-to-Quad, stereo-to-Quad, mono-to-5.0, and stereo-to-5.0 multichannel formats.



Space plug-in

Space Feature Highlights

Space features let you create the best reverb effect in the shortest possible time.

Reverb Features

- Mono, Stereo, Quad, and 5.0–channel output support
- Multiband EQ
- Independent wet/dry and decay levels
- Separate reverb early and late levels and length
- Control of early size, low-cut, and balance
- Pre delay and late delay controls
- Precise control of low, mid, and high decay crossover
- Adjustable waveform reverse, displayed in beats per minute
- Waveform processing bypass

Interface Features

- Full waveform view, zoom, and channel highlight functions
- On-screen input and output metering with clip indicators
- Impulse response information display

Impulse Response (IR) Loading and Organization Features

- Scrollable IR browser makes finding impulse responses easy
- Browser supports user-defined IR groups on any local drives
- Browser keyboard shortcuts
- IR favorites function
- Automatically recognizes common IR formats for one click loading

- Quick browser buttons allow rapid IR loading and preview

Automation and Ease of Use Features

- Snapshot mode supports rapid changes between ten predefined reverb scenes
- Picture preview mode allows you to view image files stored with impulse responses
- Impulse responses stored directly in Pro Tools presets and sessions for easy session sharing
- New impulse responses can be copied to system and loaded without closing Space
- iLok support for quick and easy relocation to other Pro Tools systems

Surround and Post-Production Features

- Full input and output surround metering on screen at all times
- Separate front, center, and rear levels
- Independent front and rear decay
- Snapshot mode ideal for post automation requirements
- Seamless snapshot switching
- Automatic phantom channel creation

IR Library

- A wide variety of both real and synthetic reverb spaces and effects
- Mono, stereo, and surround formats
- All reverb impulse responses stored in WAV file format

Space Overview

The following sections provide information on the concepts of reverb and convolution reverb.

Reverb Basics

Reverberation is an essential aspect of the sound character of any space in the real world. Every room has a unique reverb sound, and the qualities of a reverb can make the difference between an ordinary and an outstanding recording. The same reverb principles responsible for the sound of a majestic, soaring symphony in a concert hall also produce the booming, unintelligible PA system at a train station. Recordings of audio in the studio context have traditionally been captured with a minimum of real reverb, and engineers have sought to create artificial reverbs to give dry recorded material additional dimension and realism.

The first analog reverbs were created using the ‘echo chamber’ method, which consists of a speaker and microphone pair in a quiet, closed space with hard surfaces, often a tiled or concrete room built in the basement of a recording studio. Chamber reverbs offered a realistic, complex reverb sound but provided very little control over the reverb, as well as requiring a large dedicated room.

Plate reverbs were introduced by EMT in the 1950s. Plate reverbs provide a dense reverb sound with more control over the reverb characteristics. Although bulky by modern standards, plate reverb units did not require the space needed by a chamber reverb. Plate reverbs function by attaching an electrical transducer to the center of a thin plate of sheet metal suspended by springs inside a soundproof enclosure. An adjustable damping plate allows control of the reverb decay time and piezoelectric pickups attached to the plate provide the return reverb signal to the console. An alternative and less expensive analog reverb system is the spring reverb, most commonly seen in guitar amplifiers beginning

in the 1960s. Similar to the plate reverb in operation, the spring reverb uses a transducer to feed the signal into a coiled steel spring and create vibrations. These are then captured via a pickup and fed back into an amplifier.

Since the advent of digital audio technology in the 1980s, artificial reverberation has been created primarily by digital algorithms that crudely mimic the physics of natural reverb spaces by using multiple delay lines with feedback. Digital “synthetic” reverb units offer a new level of realism and control unavailable with older analog reverb systems, but still fall short of the actual reverb created by a real space.

Components of Reverb

Reverberation sound in a normal space usually has several components. For example, the sound of a single hand clap in a large cathedral will have the following distinct parts. The direct sound of the hand clap is heard first, as it travels from the hand directly to the ear which is the shortest path. After the direct sound, the first component of reverb heard by a listener is reflected sound from the walls, floor, and ceiling of the cathedral. The timing of each reflection will vary on the size of the room, but they will always arrive after the direct sound. For example, the reflection from the floor typically occurs first, followed by the ceiling and the walls. The initial reflections are known as *early reflections*, and are a function of the reflective surfaces, the position of the audio source and the relative location of the listener.

A small room may have only a fraction of a second before the first reflections, whereas large spaces may take much longer. The elapsed time of the early reflections defines the perceived size of the room from the point of view of a listener. Space offers various controls over early reflection parameters.

The time delay between the direct sound and the first reflection is usually known as *pre-delay*. Space lets you adjust pre-delay. Increasing the pre-delay often changes the perceived clarity of audio such as vocals.

Reflections continue as the audio reaches other surfaces in a space, and they create more reflections as the sound waves intermingle with one another, becoming denser and changing in character depending on the properties of the room. As the room absorbs the energy of the sound waves, the reverb gradually dies away. This is known as the *reverb tail* and may last anywhere up to a minute in the very largest of spaces.

The reverb tail will often vary at different frequencies depending on the space. Cavernous spaces often produce a booming, bassy reverb whereas other spaces may have reverb tails which taper off to primarily high frequencies. Space allows for equalization of the frequencies of the reverb tail in order to adjust the tonal characteristics of the reverb sound.

A reverb tail is often described by the time it takes for the sound pressure level of the reverb to decay 60 decibels below the direct sound and is known as *RT60*. Overall, Space lets you adjust the decay as desired. For surround processing, decay can be adjusted for individual channel groups.

Space Convolution Reverb

Convolution reverb goes beyond traditional analog and synthetic digital reverb techniques to directly model the reverb response of an actual reverb space. First, an *impulse response* (IR) is taken of an actual physical space or a traditional reverb unit. An IR can be captured in mono, stereo, surround, or any combination. The IR, as displayed by Space, clearly shows the early reflections and the long decay of the reverb tail.



Impulse Response sample

Space uses a set of mathematical functions to convolve an audio signal with the IR, creating a reverb effect directly modeled on the sampled reverb space. By using non-reverb impulse responses, Space expands from reverb applications to a general sound design tool useful for many types of audio processing.

The downside of traditional software based convolution reverbs has been the heavy CPU processing requirement, which can result in convolution reverbs with unacceptable latency. Many early software convolution reverbs did not offer adequate control over traditional reverb parameters such as Pre Delay, EQ, or decay time.

Space redefines reverb processing in Pro Tools by offering zero and low latency convolution with the full set of controls provided by traditional synthetic reverbs.

Space System Design

Space uses advanced DSP algorithms to deliver convolution reverb processing.

The following figure shows the internal system design of Space and demonstrates how Space processes the audio signal.

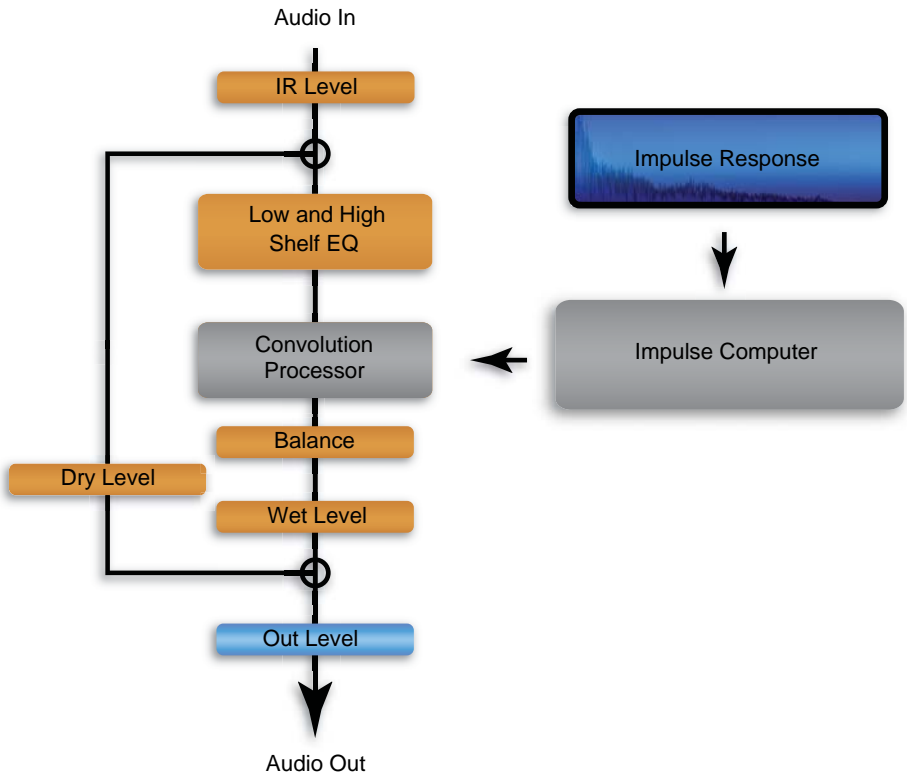

Space internal system design

The impulse computer is an internal module of Space that provides extensive control over the currently loaded impulse response waveform. When you adjust the parameters shown below, the IR is automatically recalculated by the impulse computer and reloaded into the convolution processor.

The following figure shows the internal functions of the impulse computer as it processes the waveform and loads it into the convolution processor.

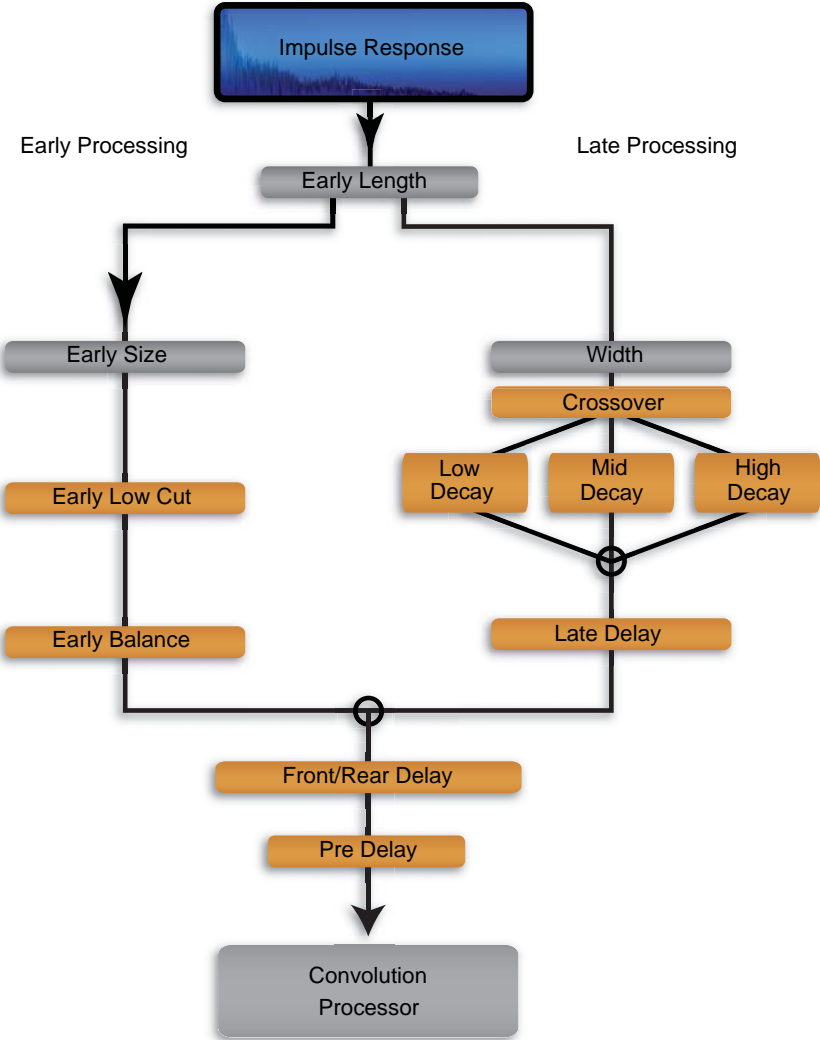

Space internal functions of the impulse computer

Impulse Response (IR) and Space

This section covers aspects of impulse response (IR) and Space.

IR Processing Control Lag

Adjusting some controls in Space requires the impulse computer to recalculate the waveform and reload it into the convolution processor. This operation uses DSP and host processing capacity. When this occurs, some control lag may be experienced. This should be kept in mind if controls are being automated in real time during a session.

How Impulse Responses Are Captured

An IR of an actual physical space is captured using a combination of an impulse sound source and capture microphones. The sound source is used to excite the physical space to create a reverb, and can be a starter pistol or a frequency tone played through a speaker. The microphones can be placed in various configurations. The resulting IR is then processed to create a digital representation of both the physical space, potentially colored by the sound source and the type of microphone used.

Similarly, an IR of a hardware effects unit can be captured by sending a test pulse through the unit and capturing the result digitally. In addition to reflecting reverb or delay characteristics, an IR also reflects tonal character and can be used for a variety of effects beyond pure reverb applications.

Depending on the capture technique used, the IR may be suitable for use with mono, stereo, surround or a combination of those formats. For example, a capture setup with a single sound source and two microphones is ideal for a mono-to-stereo IR.

Multiple IRs may be taken of a physical space where the sound source has been moved to different physical locations. Each resulting IR may be used to create individual reverbs for separate instruments. This effectively allows an engineer to place each instrument in the reverb sound field as if the instruments were physically arranged in the space.

Space IR Library Installation

You can download IR Libraries from Avid's Space Online IR Library. For more information on downloading and installing IR Libraries from the Space Online IR Library, see "Installing Space IR Packages" on page 207.

Using Third-Party IRs in Space

Space reads a wide range of IR formats automatically, including WAV and AIFF file formats, allowing you to import a variety of IRs. Space supports IR sample rates from 22 kHz up to 96 kHz in bit depths from 16 to 32 bits. In addition, Space supports the display of JPEG format picture files stored with IRs.

To use third-party IR libraries with Space:

- 1 In the IR Browser, select Edit > Import Other IR Folder.
- 2 Locate and select the library on your hard drive.
- 3 Click Choose.

Space Multichannel IR Formats

Space supports IRs in multichannel or multiple mono audio files. IRs with a single input are used for mono or summed stereo processing and can be stored as a single interleaved multichannel file, or as multi-mono files. IRs with stereo inputs used for true stereo processing must be stored as multi-mono files.

The following table shows Space IR channel formats.

Input	Output	Channel Order	File Format
Mono	Mono	—	Mono file
Mono	Stereo	L R	One 2-channel file or two mono files
Mono	Quad	L R Ls Rs	One 4-channel file or four mono files
Mono	5.0	L C R Ls Rs	One 5-channel file or five mono files
Stereo	Stereo	L R	Four mono files
Stereo	Quad	L R Ls Rs	Eight mono files
Stereo	5.0	L C R Ls Rs	Ten mono files

For multi-mono files, Space understands the following filename conventions, based on those used by Pro Tools. The filename format is based on the impulse name plus two suffixes which indicate input and output channels as follows:

Impulsename.inputchannel.outputchannel.type

- Impulsename is the name of the impulse. Mixing multiple IR files with the same Impulsename in the same folder is not supported.
- Inputchannel refers to the number of sources used for the impulse, starting at the number 1. An IR captured in true stereo will usually have two input channels numbered 1 and 2. If there is only one input channel, then inputchannel is optional and can be omitted. Also, instead of using numbers 1 and 2, the inputchannel can be designated as L and R.
- Outputchannel refers to the microphones used to capture the impulse, and corresponds to your studio monitors. outputchannel is designated using the standard L, C, R, Ls and Rs extensions.
- Type is optionally .WAV or AIFF. For best performance, filenames should always be suffixed with type to avoid Space having to open the file to determine audio format.

The following examples show how various multi-mono IR files could be named.

Stereo to Stereo IR

Cathedral.1.L.wav
Cathedral.1.R.wav
Cathedral.2.L.wav
Cathedral.2.R.wav

Stereo to 5.0 IR

Cathedral.1.L.wav
Cathedral.1.C.wav
Cathedral.1.R.wav
Cathedral.1.Ls.wav
Cathedral.1.Rs.wav
Cathedral.2.L.wav
Cathedral.2.C.wav
Cathedral.2.R.wav
Cathedral.2.Ls.wav
Cathedral.2.Rs.wav

Mono to Quad IR

Cathedral.L.wav
Cathedral.R.wav
Cathedral.Ls.wav
Cathedral.Rs.wav

Stereo to Quad IR

Cathedral.1.L.wav
Cathedral.1.R.wav
Cathedral.1.Ls.wav
Cathedral.1.Rs.wav
Cathedral.2.L.wav
Cathedral.2.R.wav
Cathedral.2.Ls.wav
Cathedral.2.Rs.wav

Channel Compatibility and Space

Space works best with IRs that match your current channel configuration. For example, if Space is instantiated in a mono to stereo configuration, stereo IRs will be highlighted in the IR browser. The IR information in the display area shows how many inputs and outputs an IR has. For example, an IR listed as 2 input 4 output is a stereo to quad IR.

If an IR is loaded that doesn't match the current configuration, Space will try to create the best possible match with the IR provided. For example, if a stereo IR is loaded into a mono instantiation of Space, Space will sum the left and right channels in order to mimic a stereo reverb with both channels panned to mono.

If an IR is loaded that is missing a required channel, Space will automatically create a phantom channel for the IR if needed. For example, if a stereo IR is loaded into a quad instantiation, Space will compute left and right surround channels automatically based on the existing channels. If a quad IR is loaded into a 5.0 channel instantiation, Space will compute a phantom center from the front left and right channels. Phantom channels are indicated by comparing the IR information displayed in the display area to the number of channels in use. For example, a 2 input 4 output IR used with a 5.0 output instantiation of Space will automatically have a phantom center channel created.

Space Presets

Space supports the Pro Tools Plug-In Librarian. When an IR file is loaded, all controls remain at their current positions, as the IR file only contains the audio waveform. By default, presets contain both the IR waveform and control settings and can be saved as required so that specific control settings can be retained for future sessions. If you save presets without embedding the IR waveform, be sure that you include the IR waveform with the session when transferring the session between different Pro Tools systems.

There are two important items to note about using presets in Space:

- Space presets do not store information for the Wet and Dry level controls. This is to enable you to change presets without losing level information. Likewise, the Pro Tools Compare function is not enabled for these controls.
- A Space preset only includes the currently selected snapshot.

 *IR files are audio files only and do not contain information about Space control settings. If you wish to save specific control settings for an IR, you should save them using the Pro Tools Plug-In Librarian or using the snapshot facility of Space.*

Space Snapshots

In addition to presets, Space lets you manage a group of settings, called *snapshots*, that can be switched quickly using a single, automatable control. Each snapshot contains a separate IR and settings for all Space controls.

IRs in a snapshot have been pre-processed by the impulse computer and can be loaded instantly into the convolution processor. Snapshots are useful, for example, in post production mixes when the reverb is changed for different scenes via automation as the picture moves from one scene to another.

Embedding IRs in Sessions, Presets, and Snapshots

By default, all IR and snapshot info used by Space (including up to ten IRs) is saved in the Pro Tools session file. Likewise, plug-in presets contain a saved copy of the IR and settings in the currently selected snapshot. Session and preset file sizes will increase as Space stores each IR waveform inside the file. This provides maximum compatibility between different Pro Tools systems without the need for them to have identical IR libraries.

IR embedding can be disabled in Space's Preferences. If IR embedding is disabled, Space stores only a reference to the name of the IR file. When the session is transferred to a different system, Space attempts to load the matching IR file from the Space IR library. For maximum compatibility, ensure that all of the appropriate IR files are available on the new system.

When working with an IR that only exists in a session file, ensure it is saved to a separate snapshot or preset. If the IR is overwritten by loading a new IR and the session is saved, the original IR cannot be recovered without access to the original IR file.

 *By default, Pro Tools presets or session files created using Space automatically include copies of all relevant IR waveforms. This provides maximum compatibility of session files between different Pro Tools systems.*

 *It is your responsibility to ensure that you observe the copyright on any IR transferred to a third party in this fashion.*

Space Controls and Displays

The Space interface is divided into the following sections:

- 1 Display area (See “Space Display Area” on page 203.)
- 2 IR Browser (See “Space IR Browser” on page 206.)
- 3 Primary controls (See “Space Primary Controls” on page 208.)
- 4 Group Selectors and Controls (See “Space Group Selectors and Controls” on page 209.)

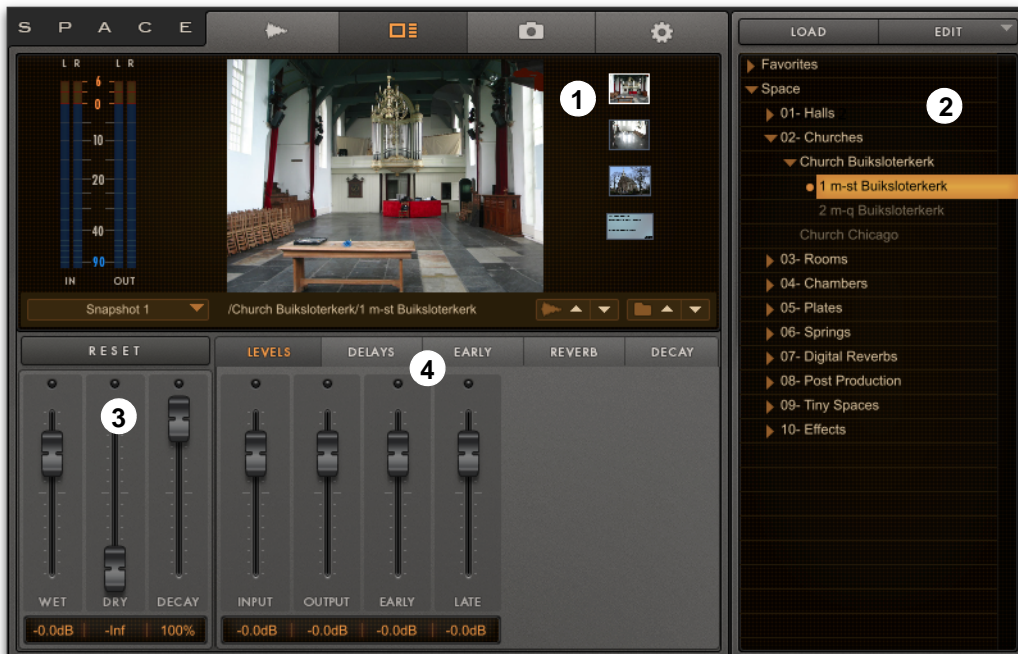

The Space interface

Space Display Area

The display area of Space operates in the following four modes, indicated by the Display Mode selectors at the top right hand corner of the Space window:

- Waveform mode
- Picture Preview mode
- Snapshot mode
- Preferences mode



Display Mode selectors

The Display area changes based on the selected mode.

Info Bar

At all times, the Info bar at the bottom of the display area window shows the following controls and information.



Info bar

Snapshot Menu A pop-up menu allowing quick selection or automation of a snapshot.

IR Name Displays the folder and file name of the currently loaded IR.

Quick Browser Controls The Quick browser controls allow the IR to be quickly changed even when the IR browser is closed, automatically loading each IR sequentially. The Waveform icons step backwards and forwards through IRs and automatically load the IR file. The Folder icons step backwards and forwards through folders. The Quick browser requires an IR to be currently loaded from

the IR browser. If no such IR is loaded (for example, the IR in use has been loaded from a preset or session but does not exist in the IR browser), the Quick browser controls are inoperative.

Space Waveform Mode

Waveform mode is selected using the Waveform icon at the top of the Space window.

Waveform mode displays the IR waveform along a horizontal axis marked in seconds and the vertical axis marked in amplitude. The early section of the waveform is highlighted in a lighter color. In addition, the channel selector highlights the current channel in the waveform.

IR information such as sample rate and number of input and output channels is displayed at the bottom right of the waveform.



Display area, Waveform mode

The controls in Waveform mode function as follows:

Original Bypasses all waveform processing, allowing the original IR to be auditioned. This control effectively bypasses the processing in the IR computer as shown in the system diagram.

Channel Selectors Displays from one to five channels (in the order Left, Center, Right, Left Surround, Right Surround). Click the desired channel to display the IR waveform for that channel. In Mono mode, no channel selector is displayed.

Zoom Zooms in and out on the time axis for the waveform display.

Space Picture Preview Mode

Picture Preview mode is selected using the Picture Preview icon at the top of the Space window. When selected, Picture Preview mode shows pictures associated with the IR. For an IR provided with Space, this will usually include a photograph of the location, and an image with technical details such as microphones used or an overview of the microphone setup. Thumbnails of images are displayed in the right hand column. In this mode, the IR browser can be used to view the associated pictures without loading the IR itself.

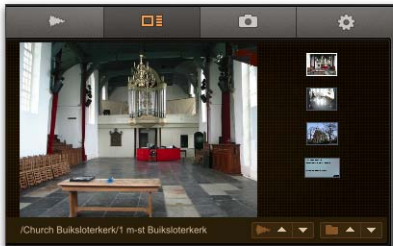

Display area, Picture Preview mode

Space Snapshot Mode

Snapshot mode is selected using the Snapshot icon at the top of the Space window. Space provides up to ten snapshots that are available at all times. Each snapshot stores a separate IR waveform and all control settings. Snapshots are optimized for quick loading into the convolution processor, and switch-

ing between snapshots is considerably faster than loading a new IR. Snapshot mode allows all ten snapshots to be viewed as well as the option to select, rename, copy, paste, and clear snapshots.

The name of the currently selected snapshot is always displayed in the Info bar at the bottom of the display area, and can be automated. This lets you switch reverb settings during playback and is useful for post production sessions where the reverb setting may change as the scene changes.



Display area, Snapshot mode

The active snapshot can be selected in one of two ways. At any time, a snapshot can be selected by using the snapshot menu in the Info bar. Alternatively, when the display area is in Snapshot mode, a snapshot can be selected by clicking the selection area next to the snapshot name.

Select Lets you select which snapshot is currently loaded.

Name Displays the name of each snapshot. By default, snapshots are named “Snapshot 1” through “Snapshot 10.” Snapshots can be renamed by clicking on the snapshot name and entering a new name followed by the Enter key (Windows) or the Return key (Macintosh).

Sample Path Displays the name of the IR selected for each snapshot.

Copy Copies the currently selected snapshot settings into a clipboard.

Paste Pastes the clipboard into the currently selected snapshot. Note that the name of the existing snapshot is not changed by pasting a new snapshot, in order to avoid duplicate snapshot names.

Clear Clears the IR from the currently selected snapshot.

Space Preferences Mode

Preferences mode is selected using the Preferences icon at the top of the Space window. This displays a number of preferences settings for Space.



Display area, Preferences mode

Embed IRs in Preset & Session Files Enables or disables the embedding of IR waveforms in presets and session file. By default, this is enabled.

Installed IR Packages Displays a list of installed Space IR packages and their versions.

Space Meters

The Meters display the amplitude of the incoming and outgoing audio signals by channel. The number of meters shown will depend on the number of input and output channels. Input meters may be mono or stereo, and output meters may be mono, stereo, quad, or 5.0 channels. Each meter is marked as either mono, left, right, center, left surround, or right surround. A logarithmic scale marked in decibels and momentary peaks are also displayed on the meter.

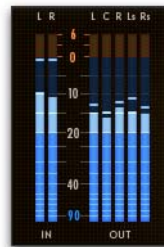

Meters, stereo input to 5.0 output shown

The red Clip indicators at the top of the meters indicate clipping on the corresponding channel.

When a channel has clipped once, the clip indicator remains lit and additional clips will be shown by a variation in the color of the indicator. The clip indicator for all channels can be cleared by clicking on any clip indicator, or selecting **Track > Clear All Clip Indicators** in Pro Tools, or pressing **Option+C** (Mac) or **Alt+C** (Windows).

Space IR Browser

The IR browser lets you quickly and easily install, locate, and organize IRs on local hard drives. The Load and Edit buttons in the IR browser let you install and import IRs, create Favorites, and change the IR groups displayed.

Space automatically highlights each IR that matches the current channel configuration. For example, when using a Space Stereo to Quad inset, each IR with that configuration is highlighted. Impulses that are not highlighted can still be loaded, and Space tries to adapt the IR to the current channel format (see “Channel Compatibility and Space” on page 200).



IR Browser

An IR can be loaded by double clicking with the mouse, or using the Load button displayed at the top of the IR browser drawer. The currently loaded IR is highlighted with a small dot next to the file name in the browser.

The IR browser can be operated using the following shortcuts. When the IR browser has keyboard focus, a blue highlight is displayed around the edge of the browser window.

IR Browser Shortcuts

Browser Navigation	Arrow Keys
Load IR	Enter (Windows) Return (Macintosh)
Open/close all folders	Alt-click (Windows) Option-click (Macintosh)
Edit menu	Right-click (Windows or Macintosh) Control-click (Macintosh)
Return keyboard focus to Pro Tools	Escape key

The IR browser lets you install and import new IRs. Each IR folder reflects a folder on the hard drive. When importing a new IR folder, a standard file dialog will be displayed to enable the user to choose the folder that contains the desired IR.

The IR browser also provides a Favorites folder, which is a user defined group of links to IRs in the IR browser. Favorites can be sorted in any desired order by dragging and dropping them as required. In addition, folders can be created in Favorites using the ‘New Folder in Favorites’ function in the Edit menu.

To add an IR file or folder to the Favorites folder:

- 1 In the IR browser, select the desired IR file or folder.
- 2 From the IR browser’s Edit menu, select Add to Favorites.

Space IR Browser Edit Menu

The IR browser's Edit menu contains the following commands:

Download Space IR Package Opens a Web browser to the Space online IR library.

Install Space IR Package Installs a new IR package downloaded from the Space online library (see "Installing Space IR Packages" on page 207).

Import Other IR Folder Lets you import a new IR folder in common file formats. By default, the new IR is given the same name as the selected folder.

Remove Imported IR Folder Lets you remove the currently selected IR folder.

Rename Imported IR Folder Lets you rename the currently selected IR folder.

Add to Favorites Adds the currently selected IR to the Favorites group at the top of the browser window.

New Folder in Favorites Creates a folder in the Favorites group. Favorite IRs can be dragged and dropped into the folder.

Rename Favorites Folder Lets you rename the currently selected Favorites folder.

Remove from Favorites Removes the currently selected IR from the Favorites group. This function only removes the link in the Favorites group and does not remove the original IR file from the system.

Reset to Default IR Library Resets Space to the default library. This also removes any user imported IR folder, but does not affect the Favorites folder, or IR packages installed from the Space online IR library.

Rescan for Files Forces Space to check the hard drive for new IRs. This is typically required if new IR files have been copied to the hard drive. Using the Rescan for Files command loads new IRs into Space without needing to close Space or the Pro Tools session.

 *Space may pause briefly while it scans the hard drives to locate IRs or if all folders are opened at once. The amount of time taken is proportional to the number of folders and IRs scanned.*

Installing Space IR Packages

Additional IR packages for Space are available for registered users to download from the Space Online IR Library at:

www.avid.com/tlspace/impulselibrary/

These package files are supplied in a lossless compressed format.

To install a Space IR package:

- 1 In the Space IR browser, select Download IR Package from the Edit menu. Your default Web browser launches and loads the Avid Space Online IR Library website.
 - 2 Click Download
 - 3 Log in using your email address and password. You may need to create a new account if you have not yet registered Space.
-  *To download IR packages from the Space Online IR Library, you must first register with Avid and create an online profile.*
- 4 Click Continue.
 - 5 Click Download for the IR package you want.
 - 6 In Space, select Install Space IR Package from the Edit menu.

- 7 In the resulting dialog, locate and select the file you downloaded.
- 8 Click Choose.
- 9 Click Install to install the IR package. A window is displayed with the results of the installation.

The IR browser in Space updates to include the new IR.

If a problem occurs with the IR installation, Space displays an error message. Review the log file stored in the Space IR library for further details. Each IR package has a version number, and Space warns you if an IR package has already been installed.

The details of all installed IR packages can be reviewed using the Show Packages option in Preferences mode.

Space Primary Controls

The primary control group is visible at all times and allows control of key reverb parameters. This includes the wet and dry levels of the audio passing through Space.



Space primary controls

Reset Resets all Space parameters except Wet, Dry, and Input and Output Level.

Wet Controls the level of wet or effected reverb signal, from $-\text{inf}$ dB to +12 dB.

Dry Controls the level of dry or unaffected reverb signal, from $-\text{inf}$ dB to +12 dB.

Decay Controls the overall decay of the IR waveform and is displayed as a percentage of the original. When Decay is adjusted, the waveform is recalculated in real time.

Space Group Selectors and Controls

Space presents reverb controls in five different groups. Each group is activated by selecting the corresponding selector.

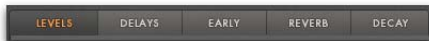

Group Selectors

Space Level Controls

The Levels group provides control of the overall input and output of the reverb, including individual controls for early and late reflections, and independent front, rear, and center levels for surround outputs.



Level controls (5.0 shown)

Input Cuts or boosts the input signal level from $-\infty$ dB to +12 dB.

Output Cuts or boosts the output signal level from $-\infty$ dB to +12 dB.

Early Cuts or boosts the levels of the early reflections from $-\infty$ dB to +12 dB.

Late Cuts or boosts the levels of the late reflections from $-\infty$ dB to +12 dB.

Front/Rear/Center In quad and 5.0 channel output modes, Space provides additional controls to attenuate or boost the Front (left and right), Rear (left and right), and Center (5.0 only) signal levels from $-\infty$ dB to +12 dB. In 5.0 output mode, the level of the center channel is affected by both the Front and Center controls.

Space Delay Controls

The Delays group provides controls for the delay timings of the reverb. When changes are made to any control in the Delays group, the IR waveform is recalculated and displayed in the Waveform display.



Delay controls (5.0 shown)

Pre Delay Adjusts length of the Pre Delay from -200 to $+200$ ms. The Pre Delay is the time between the direct sound and the first reflection. Increasing the Pre Delay often changes the perceived clarity of audio such as vocals. Pre Delay adjusts the delay of the overall impulse and affects both the Early and Late portions of the IR equally.

Pre Delay can be set to negative values to allow for subtle or radical changes to the reverb. For example, a small negative Pre Delay setting can be used to eliminate the early portion of an IR. A large negative Pre Delay setting lets you use the very end of a reverb tail for creative sounds not possible with standard reverbs.

Late Delay Adjusts length of the Late Delay from zero to +200 ms. The Late Delay is the time between the Early Reflections and the Late Reflections or tail of the reverb.

Increasing the Late Delay control from zero allows the reverb tail to be delayed so that it does not start immediately after the early portion of the IR. As Late Delay is increased, the reverb tail starts later in time and makes the reverb space sound larger. Large amounts of late delay can be used to achieve creative effects not possible with standard reverbs.

Front/Rear/Center Delay In quad and 5.0 channel output modes, adjusts length of the Front, Rear, and Center Delays independently from zero to +200 ms.

Space Early Section Controls

The Early group controls the character of the early portion of the IR and the early reflections. The primary control is Early Length which defines the size of the early portion of the IR waveform. When loading an IR from an audio file, Space relies on the user to define which part of the IR is the early portion of the waveform. By default, the Early length is set to 20 ms.



Early controls

The early portion of the IR waveform is highlighted in the Waveform display. If Early length is set to zero, then the Early setting have no effect on the audio. Otherwise, when changes are made to any control in the Early group, the IR waveform is recalculated and displayed in the Waveform display.



Early controls indicated in IR waveform

Length Adjusts the length of the Early reflections from zero to 500 ms. When set to zero, other controls in the Early group have no effect on the audio. The Early Length control adjusts the point in the impulse where the early portion ends and the late portion or tail begins.

For the most realistic reverb results, Early Length should be adjusted while viewing the waveform display. The early portion of a reverb IR is typically seen as a series of discrete spikes at the beginning of the waveform. Early Length can however be adjusted to any value to explore other creative possibilities.

Size Changes the size of the Early reflections, from 50% to 200%. Early Size expands or contracts the reflections in the early portion of the IR (as specified by the Early Length control). Reduce the Early Size to give the space a smaller, tighter sound. Increase the Early Size to give the space a larger, roomier sound.

Lo Cut Early Lo Cut controls the frequency of a highpass filter applied to the early portion of the IR (as specified by the Early Length control). The default setting of zero disables the highpass filter. As the control is set to a higher value, the corner frequency of the highpass filter is increased. Use this control to reduce boom and low frequency cancellations that can happen when mixing the reverb output with a dry signal.

Balance Early Balance controls the left/right gain balance of the early portion of the IR (as specified by the Early Length control). Adjust the Balance to control the apparent position of the reverb input in the stereo image. A negative value reduces the right channel gain. A positive value reduces the left channel gain.

! *When loading an IR from an audio file, Space relies on the user to define which part of the IR is the early portion of the waveform. If the Early Length is set to zero, controls in the Early group will not affect the IR.*

Space Reverb Section Controls

The Reverb group offers a low and high shelf EQ in addition to width and balance controls. The EQ operates prior to convolution processing.



Reverb controls

Lo Freq Adjusts the frequency of a low frequency filter from 20 to 500 Hz.

Lo Gain Cuts or boosts the frequency set in Lo Freq from -15 dB to $+15$ dB.

Hi Freq Adjusts the frequency of a high frequency filter from 500 Hz to 20 kHz.

Hi Gain Cuts or boosts the frequency set in Hi Freq from -15 dB to $+15$ dB.

Width Increase or reduces the stereo spaciousness of the reverb. Use this control to tailor the reverb's character in a mix. Keep in mind that an IR that has little stereo separation to begin with may have limited results.

Balance Controls the balance of the reverb output. Use this control to balance a reverb from an IR that has been captured without a centered stereo image, or for creatively controlling the character of the reverb in a mix.

Reverse Reverses the IR waveform and controls the total length. As the IR waveform is recalculated, it is re-displayed in the Waveform display. The value shown is measured in Beats Per Minute to let you easily match the tempo of the music.

⚠ *If the waveform is reversed using the Reverse control, effected audio may continue to play for several seconds after the transport is stopped or audio input finishes.*

Space Decay Section Controls

The Decay group controls allow the user to control the decay of the low, mid, and high frequency portions of the IR. Use the controls to tailor the reverb's character for a mix or for creative possibilities not found in traditional reverb processors.



Decay controls

Low Decreases or increases the rate at which low frequencies decay.

Low Xover Adjusts the frequency point that divides the IR into low and mid frequency portions.

Mid Decreases or increases the rate at which mid frequencies decay.

High Xover Adjusts the frequency point that divides the IR into mid and high frequency portions.

High Decreases or increases the rate at which high frequencies decay.

Front/Rear In quad and 5.0 channel output modes, Front and Rear independently control the decay for front and rear channels.

Using Space

This section addresses some common scenarios in which Space can be used during a Pro Tools session.

Using Space Presets

Space ships with a selection of factory presets for different reverb sounds. The presets are designed to give a sample of the various IRs available from the Plug-In Presets selector in conjunction with various reverb settings. However, the presets do not cover the entire IR library.

Using Space on an Effect Send

When Space is used on an Aux Input track as an effects send, the Dry control should be set to $-\infty$ dB.

Automating Space Snapshots

Snapshot automation is a powerful method of changing the reverb parameters without having to individually automate each parameter.

To automate Space Snapshots:

- 1 Insert Space on a track.
- 2 Select Snapshot mode.
- 3 Load an IR into each Snapshot and make any desired changes to specific Space controls.
- 4 Name each Snapshot as desired.
- 5 Click Auto.
- 6 Add Snapshot to the list of automated controls.
- 7 Select Space > Snapshot from the automation menu for the track.
- 8 Draw the desired automation on the track with the Pencil tool. The names displayed in the automation track will match the names entered for each Snapshot.

Space IR Library Categories

Space includes an extensive impulse response library, divided into the following categories.

Category	Description
Halls	Halls and auditoriums
Churches	Churches and chapels
Rooms	Large and small rooms
Chambers	Traditional studio reverb chambers
Plates	Classic electromechanical reverb plates
Springs	Classic electromechanical reverb springs
Digital Reverbs	Classic and contemporary digital reverb units
Post Production	Post production impulses
Tiny Spaces	Small reverbs from everyday objects
Pure Spaces	A selection of Pure Space impulses in multiple categories
Effects	Non-reverb effects for sound design in multiple categories
• Colors	Sound coloring and positioning
• Cosmic	Spacey smears and washes
• Impressions	Smears and washes that evoke an image
• Industrial	Heavy machinery
• Periodic table	Better living through chemistry

Part VI: Delay Plug-Ins

Chapter 32: Mod Delay III

Mod Delay III provides mono, multi-mono, mono-to-stereo, and stereo modulating delay effects.

Mod Delay III is available in DSP, Native, and AudioSuite plug-in formats.

Mod Delay III supports 44.1 kHz, 48 kHz, 88.2 kHz, 96 kHz, 176.4 kHz and 192 kHz sample rates.

Mod Delay III Controls

Mod Delay III provides separate sections in the plug-in window for Input and Output metering, Delay and Modulation controls, and for the Wet/Dry Mix control. Stereo and mono-to-stereo versions provide meters and controls for each channel. Delay, Modulation, and Mix controls for stereo and mono-to-stereo instances of Mod Delay III can be linked, or can be operated independently.



Mod Delay III

Input

Input Meters

The Input meters show peak signal levels before processing:

Dark Blue Indicates nominal levels from $-\infty$ to -12 dB.

Light Blue Indicates pre-clipping levels, from -12 dB to 0 dB.

Red Indicates clipping.

Phase Invert

The Phase Invert button at the top of the Input section inverts the phase (polarity) of the input signal, to help compensate for phase anomalies that can occur either in multi-microphone environments or because of mis-wired balanced connections.

To enable (or disable) phase inversion on input:

- Click the Phase Invert button so that it is highlighted. Click it again so that it is not highlighted to disable it.

Delay

Link

For stereo and mono-to-stereo tracks, enable the Link button to link the Delay, Modulation, and Mix controls between the Left and Right channels. This option is highlighted when it is enabled.

For mono tracks, this option reads Mono and is display only.

Delay Time

The Delay Time control sets the delay time between the original signal and the delayed signal (from 0.0 ms to 5,000.0 ms).

Feedback (FBK)

The Feedback setting controls the amount of feedback applied from the output of the delay back into its input (from -100% to 100%). It also controls the number of repetitions of the delayed signal. Negative feedback settings give a more intense “tunnel-like” sound to flanging effects.

Low Pass Filter (LPF)

The Low Pass Filter setting controls the cutoff frequency of the Low Pass Filter (from 10 Hz to 22 kHz). Use the LPF setting to attenuate the high frequency content of the feedback signal. The lower the setting, the more high frequencies are attenuated. The maximum value for LPF is Off. This lets the signal pass through without limiting the bandwidth of the plug-in.

Sync

When Sync is enabled, and a Duration (a rhythmic note value) is selected, the Delay Time setting is affected by the session tempo. When Sync is disabled, and a Duration is selected, the Delay Time setting is affected by changes to the Tempo setting.

When Tempo Sync is enabled, the Tempo and Meter controls are uneditable and follow the session tempo and meter changes in the Pro Tools timeline. The Duration and Groove controls apply regardless of whether Sync is enabled.

Meter

The Meter setting lets you enter either simple or compound time signatures. The Meter control defaults to a 4/4 time signature.

When Sync is enabled, the Meter control is unavailable.

Tempo

The Tempo control sets the tempo in beats per minute (from 5.00 to 500.00 bpm). This setting is independent of the Pro Tools session tempo. When a specific Duration is selected, moving this control affects the Delay Time setting.

When Sync is enabled, the Tempo control is unavailable.

Duration

The Duration setting lets you set the Delay Time based on a rhythmic value. Select a note value (whole note, half note, quarter note, eighth note, or sixteenth note). Additionally, you can select the Dot or Triplet modifier buttons to dot the selected note value or make it a triplet. For example, selecting a quarter note and then selecting the dot indicates a dotted quarter note, and selecting an eighth note and then selecting the triplet indicates a triplet eighth note.



Duration buttons

Groove

The Groove control provides fine adjustment of the delay in percentages of a 1:4 subdivision of the beat (from –100% to 100%). It can be used to add “swing” by slightly offsetting the delay from the precise beat of the track.

Modulation Section

Rate

The Rate control sets the rate of modulation of the delayed signal (from 0.00 Hz to 20.0 Hz).

Depth

The Depth control sets the depth of the modulation applied to the delayed signal (from 0% to 100%).

Mix

The Mix control sets the balance between the delayed signal (wet) and the original signal (dry). If you are using a delay for flanging or chorusing, you can control the depth of the effect somewhat with the Mix setting. Click the Dry button to set the Mix to 100% dry. Click the Wet button to set the Mix to 100% wet.

Output

The Output section provides output metering and controls for adjusting the level of the output signal.

Output Meters

The Output meters show peak signal levels after processing:

Dark Blue Indicates nominal levels from –INF to –12 dB.

Light Blue Indicates pre-clipping levels, from –12 dB to 0 dB.

Red Indicates full scale levels (clipping)

Output Gain

The Output Gain control sets the output level after processing. For mono instances of Mod Delay III, there is a single Gain control. For stereo and mono-to-stereo instances of Mod Delay III, there are independent Gain controls for each channel (left and right).

Selections for Mod Delay III AudioSuite Processing

Because AudioSuite Delay adds additional material (the delayed audio) to the end of selected audio, make a selection that is longer than the original source material to allow the additional delayed audio to be written to the end of the audio file.

If you select only the original material without leaving additional space at the end, delayed audio that occurs after the end of the selection will be cut off.

Chapter 33: Moogerfooger Analog Delay

Moogerfooger Analog Delay is a delay plug-in that is available in DSP, Native, and AudioSuite formats.

Moogerfooger Analog Delay supports 44.1 kHz, 48 kHz, 88.2 kHz, 96 kHz, 176.4 kHz and 192 kHz sample rates.

Moogerfooger Analog Delay operates as a mono, multi-mono, or stereo plug-in.



Moogerfooger Analog Delay

Moogerfooger Analog Delay provides a warm sounding delay in the digital domain. A delay circuit produces a replica of an audio signal a short time after the original signal. Mixed together, the delayed signal sounds like an echo of the original. If this mixture is fed back to the input of the delay circuit, the delayed output provides a string of echoes that repeat and die out gradually—a classic musical effect.

The Moogerfooger Analog Delay uses Bucket Brigade Analog Delay Chips to achieve its delay. These analog integrated circuits function by passing the audio waveform down a chain of thousands of circuit cells, just like water being passed by a bucket brigade to put out a fire. Each cell in the chip introduces a tiny time delay. The total time delay depends on the number of cells and on how fast the waveform is “clocked,” or moved from one cell to the next.

With the advent of digital technology, these and similar analog delay chips have gradually been phased out of production. In fact, Bob Moog secured a supply of the last analog delay chips ever made, and used them to build a Limited Edition of 1,000 “real-world” Moogerfooger Analog Delay units.

Compared to digital delays, the frequency and overload contours of well-designed analog delay devices generally provide smoother, more natural series of echoes than digital delay units. Another difference is that the echoes of a digital delay are static because they are the same digital sound repeated over and over, whereas a bucket brigade device itself imparts a warm, organically evolving timbre to the echoes.

Avid’s digital replica re-creates all the warm, natural sounds of its analog counterpart. The Moogerfooger Analog Delay plug-in was enhanced to be even more useful for digital recording. An integrated Highpass Filter allows you to remove un-

wanted bass buildup from the feedback loop, allowing you to have warmer, more controllable echo swarms while minimizing the potential for digital clipping.

Moogerfooger Analog Delay Controls

The Moogerfooger Analog Delay provides the following controls:

Delay Time Delay Time allows you to select the length of delay between the original and the delayed signal. Used with Feedback, it also affects how long apart the echoes are.

Short/Long The Short/Long switch sets the range of the Delay Time control. Set to Short, the Delay Time ranges from 0.04 to 0.4 seconds. Set to Long, it ranges from 0.08 to 0.8 seconds.

Feedback Feedback determines how much signal is fed back to the delay input, affecting how fast the echoes die out.

Highpass The Highpass knob removes low frequencies from the feedback loop. It removes undesirable low frequency “mud” common when mixing with delays and also allows the creation of amazing echo swarms that won’t clip the output. Dial in a highpass frequency from 50 Hz to 500 Hz. Frequencies below the setting are filtered from the feedback loop.

HPF On/Off The HPF Off/HPF On enables or disables the highpass filter (HPF).

Drive The Drive control sets the input gain.

Mix The Mix control blends the original input signal with the delayed signal.

LED Indicators

Three LEDs down the center of the unit provide visual feedback.

Input Level The Input Level LED glows green when signal is present.

HPF The HPF LED turns green when the highpass filter is enabled.

Bypass The Bypass LED glows either red (bypassed) or green (not bypassed) to show whether or not the effect is in the signal path.

Moogerfooger Analog Delay Tips and Tricks

Infidelity

Because analog delay chips offer only a fixed number of cells, the extended delay times store a lower-fidelity version of the input signal. Try the Long delay setting when going for cool “lo-fi” sounds and textures.

Echo Swarms

By carefully adjusting the Feedback, Drive, and Highpass controls, you can use the Moogerfooger Analog Delay as a sound generator. Simply pulse the delay unit with a short piece of audio (even a second will do), and adjust the Delay Time knob. Set correctly, the unit will generate cool timbres for hours all by itself.

Chapter 34: Reel Tape Delay

Reel Tape Delay is part of the Reel Tape suite of tape-simulation effects plug-ins. Reel Tape Delay simulates an analog tape echo effect, modeling the frequency response, noise, wow and flutter, and distortion characteristics of analog tape. It also reproduces the varispeed effect you get when the tape speed control is adjusted.

Reel Tape Delay is available in DSP, Native, and AudioSuite formats.

Reel Tape Delay supports 44.1 kHz, 48 kHz, 88.2 kHz, 96 kHz, 176.4 kHz and 192 kHz sample rates.

Reel Tape Delay operates as a mono, multi-mono, or stereo plug-in.



Reel Tape Delay

For years, engineers have relied on analog tape to add a smooth, warm sound to their recordings.

When driven hard, tape responds with gentle distortion rather than abrupt clipping as in the digital domain. Magnetic tape also has a frequency-dependent saturation characteristic that can lend punch to the low end, and sweetness to the highs.

Reel Tape Delay models a studio tape machine in record/playback mode, with a fixed distance between the record head and the play head, and a continuously variable tape speed.

Reel Tape Delay automatically applies tape saturation effects that correspond to the following control settings in Reel Tape Saturation:

- Speed: 15 ips
- Bias: 0.0 dB
- Cal Adjust: +9 dB

You can use the BPM Sync feature to synchronize the Reel Tape Delay effect to the current tempo of the Pro Tools session.

Reel Tape Delay can be placed on mono, stereo, or multichannel tracks.

Reel Tape Common Controls

All Reel Tape plug-ins share the following controls:

Drive

Drive controls the amount of saturation effect by increasing the input signal to the modeled tape machine while automatically compensating by reducing the overall output. Drive is adjustable from -12 dB to +12 dB, with a default value of 0 dB.

Output

Output controls the output signal level of the plug-in after processing. Output is adjustable from -12 dB to +12 dB, with a default value of 0 dB.

Tape Machine

The Tape Machine control lets you select one of three tape machine types emulated by the plug-in, each with its own sonic characteristics:

US Emulates the audio characteristics of a 3M M79 multitrack tape recorder.

Swiss Emulates the audio characteristics of a Studer A800 multitrack tape recorder.

Lo-Fi Simulates the effect of a limited-bandwidth analog tape device, such as an outboard tape-based echo effect.

Tape Formula

The Tape Formula control lets you select either of two magnetic tape formulations emulated by the plug-in, each with its own saturation characteristics:

Classic Emulates the characteristics of Ampex 456, exhibiting a more pronounced saturation effect.

Hi Output Emulates the characteristics of Quantegy GP9, exhibiting a more subtle saturation effect.

Reel Tape Delay Controls

In addition to the Drive, Output, Tape Machine, and Tape Formula controls, Reel Tape Delay has the following controls:

Speed

The Speed control adjusts the delay time, calibrated to tape speed. A slower tape speed results in a longer delay. A faster tape speed results in a shorter delay.

The displayed tape Speed value corresponds to the delay time resulting from the distance between the record and play heads on an Ampex 440-series tape transport.

Tape speed is adjustable from approximately 1 7/8 ips (1486 ms delay) to approximately 30 ips (93 ms delay), with a default value of approximately 15 ips (172 ms delay).

You can synchronize the delay time to the current tempo of the Pro Tools session. See “Synchronizing Reel Tape Delay to Session Tempo” on page 223.

Feedback

The Feedback control adjusts the amount of delayed output fed back into the input, allowing generation of multiple echoes. A higher feedback amount results in more echo regeneration. A lower feedback amount results in less echo regeneration. Feedback amount is adjustable from 0 to 100 percent, with a default value of 30 percent.

Wow/Flutter

The Wow/Flutter control adjusts the amplitude of the tape machine's wow and flutter, or the amount of fluctuation in tape speed. A higher setting results in wider fluctuations in speed. A lower setting results in narrower fluctuations in speed. Wow/Flutter is adjustable from 0 to 1 percent, with a default value of 0.20 percent.

Wow Speed

(Plug-In Automation Playlist or Control Surface Access Only)

The Wow Speed parameter adjusts the frequency of the tape machine's wow effect, or the rate of fluctuation in tape speed. A higher value results in faster fluctuations in speed. A lower value results in slower fluctuations in speed. Wow Speed is adjustable from 0 to 100 percent, with a default value of 50 percent.

This parameter is accessible only from the plug-in automation playlist or from a supported control surface.

 *Settings for this parameter are saved with plug-in presets. If you use a preset for the Native, DSP, or AudioSuite version of this plug-in, any settings for this parameter will be active.*

Bass

The Bass control boosts or cuts the amount of low frequencies fed to the echo feedback loop. Bass amount is adjustable from -10 dB to +10 dB, with a default value of 0 dB.

 *Note that this control does not affect the first delayed signal, only the repeated delays caused by the Feedback control.*

Treble

The Treble control boosts or cuts the amount of high-mid frequencies fed to the echo feedback loop. Treble amount is adjustable from -10 dB to +10 dB, with a default value of 0 dB.

 *Note that this control does not affect the first delayed signal, only the repeated delays caused by the Feedback control.*

Mix

The Mix control adjusts the amount of processed signal mixed with the input signal in the final output of the plug-in. The default Mix value is 25 percent.

Noise

(Plug-In Automation Playlist or Control Surface Access Only)

The Noise parameter controls the level of simulated tape hiss that is added to the processed signal. Noise is adjustable from Off (-INF) to -24 dB, with a default value of -80 dB.

This parameter is accessible only from the plug-in automation playlist or from a supported control surface.

 *Settings for this parameter are saved with plug-in presets. If you use a preset for the Native, DSP, or AudioSuite version of this plug-in, any settings for this parameter will be active.*

Synchronizing Reel Tape Delay to Session Tempo

You can set the delay time (Speed control) in the Reel Tape Delay to synchronize to the session tempo (in beats per minute).

To synchronize the delay time to the session tempo:

- 1 In the BPM Sync section, click the On button. The Tempo/Rate display changes to match the current session tempo.

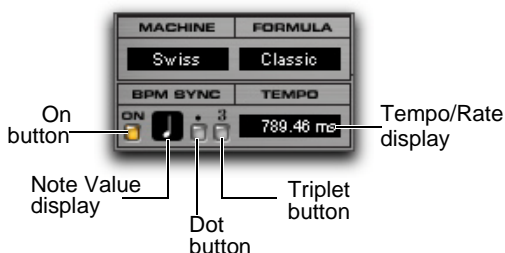

BPM Sync controls

- 2 To set a rhythmic delay, click the Note Value to choose from the available note values (whole, half, quarter, eighth, sixteenth, or thirty-second note)
- 3 To adjust the rhythm further, do any of the following:
 - To enable triplet rhythm delay timing, click the Triplet (“3”) button so that it is lit.
 - To set a dotted rhythm delay value, click the Dot (“.”) button so that it is lit.

 You can override the settings derived from BPM Sync at any time by manually adjusting the plug-in Speed control.

 To set the delay time to a specific time value, turn off BPM Sync and enter the delay time (in msec) in the Tempo/Rate display.

Reel Tape Delay Presets

The Reel Tape Delay presets coordinate Speed, Wow/Flutter, Feedback and the Bass and Treble controls for different tape speeds.

3.75 ips Sets the delay time to correspond to a Speed Control setting of 3.75 inches per second.

3.75 ips Flutter Includes the 3.75 ips setting plus Wow/Flutter.

7.5 ips Sets the delay time to correspond to a Speed Control setting of 7.5 inches per second.

7.5 ips Flutter Includes the 7.5 ips setting plus Wow/Flutter.

30 ips Flutter Adds Wow/Flutter to the highest Speed Control setting.

Rockabilly A common tape slap effect, useful on vocals or electric guitar. Sets the delay time to 130 ms, which corresponds to the delay time resulting from the distance between the record and play heads on an Ampex 300-series or Ampex 350-series tape transport.

Rockabilly Plus Includes the Rockabilly setting plus Feedback, Wow/Flutter, Bass and Treble adjustments on feedback.

Chapter 35: Tel-Ray Variable Delay

Tel-Ray Variable Delay is a delay/echo plug-in that is available in DSP, Native, and AudioSuite formats.

Tel-Ray Variable Delay supports 44.1 kHz, 48 kHz, 88.2 kHz, 96 kHz, 176.4 kHz and 192 kHz sample rates.

Tel-Ray Variable Delay operates as a mono, multi-mono, or stereo plug-in.



Tel-Ray Variable Delay

Add delay or echo to any voice or instrument using the Tel-Ray Variable Delay. It provides lush delay, amazing echo, and warms up your tracks and mixes.

In the early 1960s, a small company experimented with electronics and technology. When they came up with something great, they would Tell Ray (the boss).

One invention involved a tuna can, a motor, and a few tablespoons of oil. The creation: an Electronic Memory Unit. A technology, they were sure, that would be of great interest to companies like IBM and NASA.

Though it never made it to the moon, most every major guitar amp manufacturer licensed the technology that gives Tel-Ray its unique sound.

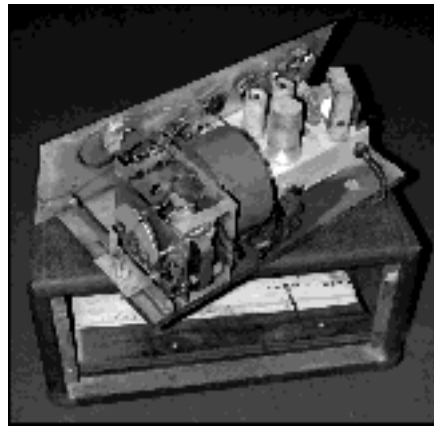

Space-age technology in a can

Tel-Ray Controls

Input/Output Section

Input Input sets the signal level to the tuna can echo unit.

Tone Tone is a standard tone control like those commonly found on guitar effects.

Mix Mix adjusts the amount of dry (unprocessed) signal relative to the amount of wet (processed) signal. Full clockwise is 100% wet. (On original units, this control is located deep inside the box, typically soaked in carcinogenic PCB oil.)

Output Output is a simple digital output trim control.

Echo/Delay Section

Variable Delay Variable Delay selects the delay time. Delay times vary from 0.06 to 0.3 seconds. Full clockwise is slowest.

Variation Variation adjusts how much variation occurs in the delay. The more variation you use, the more warbled and wobbly the sound becomes.

Sustain Sustain determines how long the delay takes to die out. It is actually a feedback control similar to the one found on the Moogerfooger Analog Delay.

Echo/Doubler Echo/Doubler determines whether or not a second record head is engaged, resulting in a double echo.

Tel-Ray Tips and Tricks

Each and every Tel-Ray varies drastically in motor and flywheel stability, resulting in different pitch and variation effects. Even the same unit may sound different day to day, depending on temperature, warm-up time, and other factors. Since the original units are basically thirty year-old tuna cans bolted to plywood with springs and motors flopping around inside, the virtual Tel Ray Delay provides a Variation knob so that you can dial in a Tel-Ray in whatever state of disrepair you desire.

Chapter 36: TimeAdjuster

TimeAdjuster is a time-processing plug-in that is available in DSP and Native formats.

TimeAdjuster supports 44.1 kHz, 48 kHz, 88.2 kHz, 96 kHz, 176.4 kHz and 192 kHz sample rates.

TimeAdjuster operates as a mono, multi-mono, or stereo plug-in.



TimeAdjuster (Stereo)

Use the TimeAdjuster plug-in for any of the following:

- Delay compensation
- Gain compensation (+/- 24 dB)
- Phase inversion for correcting out-of-phase signals



For more information on Delay Compensation and Time Adjuster, see the Pro Tools Reference Guide.

TimeAdjuster Controls

The TimeAdjuster plug-in provides the following controls:

Phase Invert This controls inverts the phase (polarity) of the input signal. While most Avid plug-ins supply a phase invert button of their own, some third-party plug-ins may not. Phase inversion is also useful for performing delay compensation by tuning unknown delay factors by ear (see “Using TimeAdjuster for Manual Delay Compensation” on page 227).

Gain Provides up to 24 dB of positive or negative gain adjustment. This control is useful for altering the gain of a signal by a large amount in real time. For example, when you are working with audio signals that are extremely low level, you may want to adjust the channel gain to a reasonable working range so that a fader is positioned at its optimum travel position. Use the Gain control as an insert effect to make a wide range of gain adjustment in real time without having to permanently process the audio files, as you would with an AudioSuite plug-in.

Delay Provides up to 8192 samples of delay compensation adjustment, or general adjustment of phase relationships of audio recorded with multiple microphones (the amount of delay available depends on the version of TimeAdjuster: Short, Medium, or Long). It defaults to a minimum delay of four samples, which is the delay created by use of the TimeAdjuster plug-in itself.

While phase inversion controls have been used for many years by engineers as creative tools for adjustment of frequency response between multiple microphones, sample-level delay adjustments provide far more control. Creative use of this control can provide a powerful tool for adjusting frequency response and timing relationships between audio signals recorded with multiple microphones.

Using TimeAdjuster for Manual Delay Compensation

DSP and host-based processing in all digital systems incurs delay of varying amounts. You can use the TimeAdjuster plug-in to apply an exact number of samples of delay to the signal path of a Pro Tools track to compensate for delay incurred by specific plug-ins. TimeAdjuster provides presets for common delay-compensation scenarios.

To compensate for several plug-ins in-line, use the delay times from each settings file as references, and add them together to derive the total delay time.

 *Some plug-ins (such as Avid's Maxim) have different delays at different sample rates.*

Alternatively, look up the delay in samples for the plug-ins you want to compensate for, then apply the appropriate amount of delay.

To manually compensate for DSP-induced delays, try one of the following methods:

- Phase inversion
- Comb-filter effect cancellation

Phase Inversion

If you are working with phase-coherent track pairs, or tracks recorded with multiple microphones, you can invert the phase to negate the delay. If you don't hear any audio when you invert a signal's phase, you have precisely adjusted and compensated for the delay. This is because when you monitor duplicate signals and invert the polarity (phase) of one of them, the signals will be of opposite polarity and cancel each other out. This technique is convenient for finding the exact delay setting for any plug-in.

To determine the delay of a plug-in by inverting its signal phase:

- 1 Place duplicate audio clips on two different audio tracks and pan them to the center (mono).
- 2 Apply the plug-in whose delay you want to calculate to the first track, and a Time Adjuster plug-in to the second track.
- 3 With TimeAdjuster, invert the phase.
- 4 Control-drag (Windows) or Command-drag (Mac) to fine-tune delay in one sample increments, or use the up/down arrow keys to change the delay one sample at a time until the audio signal disappears.
- 5 Change the polarity back to normal.
- 6 Save the TimeAdjuster setting for later use.

Comb-Filter Effect Cancellation

Adjust the delay with the signal in phase until any comb-filter effects cancel out.

Viewing Channel Delay and TimeAdjuster

Because plug-ins display their delay values in the channel delay indicators, this can be used as another method for determining delay compensation.

To view time delay values and use TimeAdjuster to compensate for the delay:

- 1 Do one of the following:
 - Control-click (Windows) or Command-click (Mac) the Track Level Indicator to toggle between level (that appears on the display as “vol”), headroom (“pk”), and channel delay (“dly”) indications. Delay values are shown in samples.
 - Select the Delay Compensation view from the Mix Window View selector. This view will appear below the track name. Delay, User Offset, Compensation Amount values are shown in samples.



*Determining the DSP delay of track inserts
(Mix window shown)*

- 2 Apply the TimeAdjuster plug-in to the track whose delay you want to increase, and Control-click (Windows) or Command-click (Mac) its Track Level indicator until the channel delay value is displayed for that track.
- 3 Change the delay time in TimeAdjuster by moving the Delay slider or entering a value in the Delay field, until the channel delay value matches that of the first track.
- 4 Test the delay values by duplicating an audio track and reversing its phase while compensating for delay.

When to Compensate for Delays

If you want to compensate for delays across your entire system with Time Adjuster, you will want to calculate the maximum delay incurred on any channel, and apply the delays necessary to each channel to match this channel.

However, this may not always be necessary. You may only really need to compensate for delays between tracks where phase coherency must be maintained (as with instruments recorded with multiple microphones or stereo pairs). If you are working with mono signals, and the accumulated delays are small (just a few samples, for example), you probably needn't worry about delay compensation.

 *For more information about delays and mixing with Pro Tools, see the Pro Tools Reference Guide.*

Part VII: Modulation Plug-Ins

Chapter 37: Moogerfooger Lowpass Filter

Moogerfooger Lowpass Filter features a 2-pole/4-pole variable resonance filter with envelope follower. Use it to achieve classic 60s and 70s sounds on bass and electric guitar, or just dial in some warm, fat virtual analog resonance when you need it.

Moogerfooger Lowpass Filter is available in DSP, Native, and AudioSuite formats.

Moogerfooger Lowpass Filter supports 44.1 kHz, 48 kHz, 88.2 kHz, 96 kHz, 176.4 kHz and 192 kHz sample rates.

Moogerfooger Lowpass Filter operates as a mono, multi-mono, or stereo plug-in.

With the invention of the MOOG® synthesizer in the 1960s, Bob Moog started the electronic music revolution. A direct descendant of the original MOOG Modular synthesizers, the Moogerfooger Lowpass Filter provides two classic MOOG modules: a Lowpass Filter and an Envelope Follower.

A low pass Filter allows all frequencies up to a certain frequency to pass, and cuts frequencies above the cutoff frequency. It removes the high frequencies from a tone, making it sound more mellow or muted. The Moogerfooger Lowpass Filter contains a genuine four-pole lowpass filter. We say “genuine” because the four-pole filter—a major part of the “MOOG Sound” of the 60s and 70s—was first patented by Bob Moog in 1968! The digital version preserves all the character, nuances, and personality of his original classic analog design.



Moogerfooger Low Pass Filter

An Envelope Follower tracks the loudness contour, or envelope, of a sound. Think of it like this: each time you play a note, the envelope goes up and then down. The louder and harder you play, the higher the envelope goes. In the Moogerfooger Lowpass Filter, the Envelope Follower drives the cutoff frequency of the Lowpass Filter. Since the envelope follows the dynamics of the input, it “plays” the filter by sweeping it up and down in response to the loudness of the input signal.

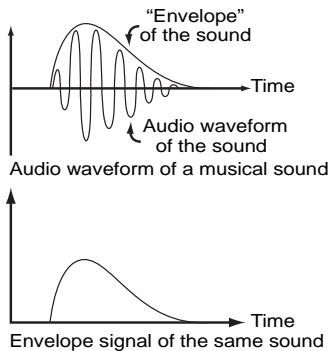

Envelope

Moogerfooger Lowpass Filter Controls

Envelope Section

Amount The Amount knob determines how much the envelope varies the filter. When the knob is counterclockwise, the envelope signal has no effect on the filter. When the knob is fully clockwise, the envelope signal opens and closes the filter over a range of five octaves.

Smooth/Fast The Smooth/Fast switch determines how closely the envelope tracks the loudness of the input signal. Some sounds (like guitar chords) have long, rough envelopes, and often sound better with less dramatic changes in the filter. Other sounds (like bass or snare drum) are quick and sharp, and sound great when the filter closely tracks their attack.

Mix The Mix control blends the original input signal with the filtered signal. Use it to get any mixture of filtered and unfiltered sound.

Filter Section

Control the filter using the Cutoff and Resonance knobs and the 2-Pole/4-Pole switch.

Cutoff Cutoff opens and closes the filter. Turned counterclockwise, fewer high frequencies pass through the filter. Turned clockwise, more high frequencies pass.

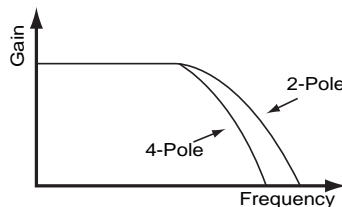

The 2/4 pole switch selects the filter slope

Resonance Resonance changes the way the filter sounds. At low resonance, low frequencies come through evenly. At high resonance, frequencies near the cutoff frequency are boosted, creating a whistling or vowel-type quality. When resonance is maxed out, the filter oscillates and produces its own tone at the cutoff frequency. This oscillation interacts with other tones as they go through the filter, producing the signature Moog sound.

2-Pole/4-Pole The 2-Pole/4-Pole switch selects whether the signal goes through half the filter (2-pole) or the entire filter (4-pole). 2-pole is brighter, while 4-pole has a deeper, mellow quality.

Drive The Drive control sets the input gain. Use it to adjust the input to the filter and envelope follower.

LED Indicators

Three LEDs down the center of the unit provide visual feedback.

Level Level glows green when signal is present to the envelope circuit.

Env Env (envelope) glows redder in response to the envelope tracking of the input.

Bypass Bypass glows either red (bypassed) or green (not bypassed) to show whether or not the effect is in the signal path.

Moogerfooger Lowpass Filter Tips and Tricks

Try inserting an LFO ahead of the Moogerfooger Lowpass Filter to produce a cool “auto wah” effect. Use this in conjunction with Voce Spin’s rotating speaker for a swirling auto-wah effect.

Chapter 38: Moogerfooger 12-Stage Phaser

Moogerfooger 12-Stage Phaser combines a 6- or 12-stage phaser with a wide-ranging variable LFO. Start with subtle tremolo or radical modulation effects, then crank the distortion and resonant filters for unbelievable new tones—all featuring classic MOOG sound.

Moogerfooger 12-Stage Phaser is available in DSP, Native, and AudioSuite formats.

Moogerfooger 12-Stage Phaser supports 44.1 kHz, 48 kHz, 88.2 kHz, 96 kHz, 176.4 kHz and 192 kHz sample rates.

Moogerfooger 12-Stage Phaser operates as a mono, multi-mono, or stereo plug-in.



Moogerfooger 12-stage Phaser

Moogerfooger 12-Stage Phaser offers 6 or 12 stages of MOOG resonant analog filters. Unlike the Lowpass Filter, however, the filters are arranged in an allpass configuration.

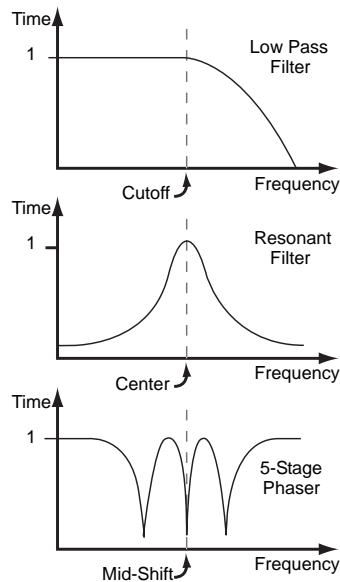

Different types of filters

A phaser works by sweeping the mid-shift frequency of the filters back and forth. As this happens, the entire frequency response of the output moves back and forth as well. The result is the classic phaser “whooshing” sound as different frequency bands of the signal are alternately emphasized and then attenuated.

A sweep control allows you to adjust the range of the frequency shift. And, keeping in the spirit of the MOOG modular synthesizers, an integrated LFO allows you to modulate the sweep control, allowing for extreme effects.

Moogerfooger 12-Stage Phaser Controls

LFO Section

Control the LFO using the Amount and Rate knobs and the Lo/Hi selector switch.

Amount Amount varies the depth of phaser modulation, from barely perceptible at the full counter-clockwise position, to the full sweep range of the phaser (full clockwise or “Kill” setting).

Rate Rate determines how fast the LFO oscillates. The LFO light blinks to give a visual indication of the LFO rate.

Lo/Hi The Lo/Hi switch selects the range of the Rate control. When the switch is Lo, the Rate control varies from 0.01 Hz (one cycle every hundred seconds) to 2.5 Hz (2.5 cycles every second). When the switch is Hi, the Rate control varies from 2.5 Hz (2.5 cycles every second) to 250 Hz (two hundred fifty cycles per second). With such a wide range of rates available, obviously you’ll need to adjust Rate after you flick the Lo/Hi switch to get the sound you desire.

Phaser Section

Control the Phaser with the Sweep and Resonance knobs and the 6-Stage/12-Stage switch.

Resonance Resonance adjusts the feedback of the analog filters. As you add more resonance, the peaks caused by the filters get sharper and more noticeable.

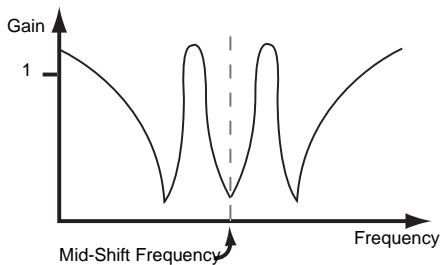

Responses of a phaser with high resonance

Sweep Sweep adjusts the center frequency point of the filters. Use it in conjunction with Amount to control the frequencies affected by the phaser.

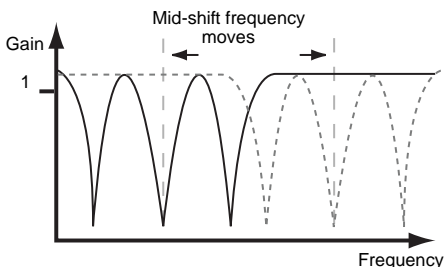

Sweep adjusts the center frequency point

Drive

The Drive control sets the input gain.

LED Indicators

Three LEDs provide visual feedback.

Level Level glows green when signal is present.

LFO LFO blinks to show the LFO rate.

Bypass Bypass glows either red (bypassed) or green (not bypassed) to show whether or not the effect is in the signal path.

Moogerfooger 12-Stage Phaser Tips and Tricks

More Harmonics = More Fun

The richer the harmonic content of the sound, the more there is to filter and sweep. Try adding distortion using the SansAmp PSA-1 before the phaser—it's a cool variation on the common signal path used when putting a phaser in front of a guitar amp.

Aggressive and Extreme

Dr. Moog apparently took these mantras of early 21st Century recording science to heart when he designed the Rate knob on his phaser. Flick the Rate switch to Hi and let the party begin. Try muting a track and mixing in bits of extremely phase-swept material.

It's an Effect—Play with It!

All the controls on the Moogerfooger 12-Stage Phaser are fully independent of one another. This means you can set them in any combination that you wish. There is no such thing as a “wrong” combination of settings, so you can experiment all you like to find new, exciting effects for your music.

Chapter 39: Moogerfooger Ring Modulator

Moogerfooger Ring Modulator provides a wide-range carrier oscillator and dual sine/square waveform LFO. Add motion to rhythm tracks and achieve radical lo-fidelity textures—you set the limits!

Moogerfooger Ring Modulator is available in DSP, Native, and AudioSuite formats.

Moogerfooger Ring Modulator supports 44.1 kHz, 48 kHz, 88.2 kHz, 96 kHz, 176.4 kHz and 192 kHz sample rates.

The Moogerfooger Ring Modulator operates as a mono, multi-mono, or stereo plug-in.

Like the Lowpass Filter, the Moogerfooger Ring Modulator has its roots in the original MOOG Modular synthesizers. It provides three classic MOOG modules: a Low Frequency Oscillator, a Carrier Oscillator, and a Ring Modulator.

Low Frequency Oscillators (or LFOs) create slow modulations like vibrato and tremolo. The LFO in the Moogerfooger Ring Modulator is a wide-range, dual-waveform (sine/square) oscillator.

The Carrier Oscillator is a wide-range sinusoidal oscillator. It's called the Carrier Oscillator because, like the carrier of an AM radio signal, it's always there, ready to be modulated by the input.

A Ring Modulator takes two inputs, and outputs the sum and difference frequencies of the two inputs. For example, if the first input contains a 500 Hz sine wave, and the second input contains a 100 Hz sine wave, then the output contains a 600 Hz sine wave (500 plus 100) and a 400 Hz (500 minus 100) sine wave.



Moogerfooger Ring Modulator

Moogerfooger Ring Modulator Controls

LFO Section

Control the LFO using the Amount and Rate knobs and the Square/Sine waveform selector switch.

Amount Amount determines the amount of LFO waveform that modulates the frequency of the carrier oscillator. When the knob is full counterclockwise, the carrier is unmodulated. Fully clockwise, the carrier oscillator is modulated over a range of three octaves.

Rate Rate determines how fast the LFO oscillates, from 0.1 Hz (one cycle every ten seconds) to 25 Hz (twenty-five cycles per second). The LFO light blinks to give a visual indication of the LFO rate.

Sine/Square The Square/Sine switch selects either a square or sine waveform. The square wave produces trill effects, whereas the sine waveform produces vibrato and siren effects.

Modulator Section

The Carrier Oscillator is controlled by the Frequency knob and the Low/High switch.

Frequency Knob Operating at the selected frequency, the carrier oscillator provides one input to the ring modulator, with the other coming from the input signal.

Lo In the Lo position, the Frequency knob ranges from 0.5 Hz to 80 Hz.

Hi In the High position, the Frequency knob ranges from 30 Hz to 4 kHz.

Mix The Mix control blends the input signal and the Ring Modulator output. You hear only the input signal when the knob is counterclockwise, and only the ring modulated signal with the knob fully clockwise.

Drive

The Drive control sets the input gain.

LED Indicators

Three LEDs provide visual feedback.

Level Level glows green when signal is present.

LFO LFO blinks to show the LFO rate.

Bypass Bypass glows either red (bypassed) or green (not bypassed) to show whether or not the effect is in the signal path.

Moogerfooger Ring Modulator Tips and Tricks

You'll discover tons of great uses for the Moogerfooger Ring Modulator through experimentation. But don't forget to try using it in subtle ways, adding "just a hint" to harshen up or add a metallic quality to individual tracks buried in the mix. Almost all the great MOOG sounds feature subtle, clever uses of Ring Modulation.

Chapter 40: Reel Tape Flanger

Reel Tape Flanger is part of the Reel Tape suite of tape-simulation effects plug-ins. Reel Tape Flanger simulates a tape machine flanging effect, modeling the frequency sweep and “crossover” comb-filtering effects that can result when the flanger variable delay is adjusted. It also reproduces the frequency response, noise, wow and flutter, and distortion characteristics of analog tape recording.

Reel Tape Flanger is available in DSP, Native, and AudioSuite formats.

Reel Tape Flanger supports 44.1 kHz, 48 kHz, 88.2 kHz, 96 kHz, 176.4 kHz and 192 kHz sample rates.

Reel Tape Flanger operates as a mono, multi-mono, or stereo plug-in.



Reel Tape Flanger

For years, engineers have relied on analog tape to add a smooth, warm sound to their recordings.

When driven hard, tape responds with gentle distortion rather than abrupt clipping as in the digital domain. Magnetic tape also has a frequency-dependent saturation characteristic that can lend punch to the low end, and sweetness to the highs.

Reel Tape Flanger models a classic tape flanging setup with two analog tape machines and a mixer, where one tape machine has a fixed delay and the other has a continuously variable delay.

The two machines are fed an input signal in parallel, and the output of the machines is then mixed. When the variable delay on the second machine is changed at a constant rate (using an LFO), the resulting frequency cancellations cause a periodic phasing of the original signal.

The use of a fixed delay on the first machine makes it possible to adjust the variable delay on the second machine to pass the “zero” point (to a delay value less than the fixed delay), resulting in phase cancellation (or the “crossover” flanging effect).

Reel Tape Flanger automatically applies tape saturation effects that correspond to the following control settings in Reel Tape Saturation:

- Speed: 15 ips
- Bias: 0.0 dB
- Cal Adjust: +9 dB

Use the BPM Sync feature to synchronize the Reel Tape Flanger effect to the current tempo of the Pro Tools session.

Reel Tape Common Controls

All Reel Tape plug-ins share the following controls:

Drive

Drive controls the amount of saturation effect by increasing the input signal to the modeled tape machine while automatically compensating by reducing the overall output. Drive is adjustable from -12 dB to +12 dB, with a default value of 0 dB.

Output

Output controls the output signal level of the plug-in after processing. Output is adjustable from -12 dB to +12 dB, with a default value of 0 dB.

Tape Machine

The Tape Machine control lets you select one of three tape machine types emulated by the plug-in, each with its own sonic characteristics:

US Emulates the audio characteristics of a 3M M79 multitrack tape recorder.

Swiss Emulates the audio characteristics of a Studer A800 multitrack tape recorder.

Lo-Fi Simulates the effect of a limited-bandwidth analog tape device, such as an outboard tape-based echo effect.

Tape Formula

The Tape Formula control lets you select either of two magnetic tape formulations emulated by the plug-in, each with its own saturation characteristics:

Classic Emulates the characteristics of Ampex 456, exhibiting a more pronounced saturation effect.

Hi Output Emulates the characteristics of Quantegy GP9, exhibiting a more subtle saturation effect.

Reel Tape Flanger Controls

In addition to the Drive, Output, Tape Machine, and Tape Formula controls, Reel Tape Flanger has the following controls:

Range

The Range control adjusts the overall magnitude of the variable delay, which determines the offset between the two modeled tape machines. A center or “zero” setting results in no offset. Range is continuously adjustable from -20 ms to +20 ms, and is divided into two types of effects: flanging and automatic double tracking.

Flange Range settings within the narrow center band around “zero” simulate tape *flanging*, with a phase cancellation effect as the variable delay crosses the “zero” point.

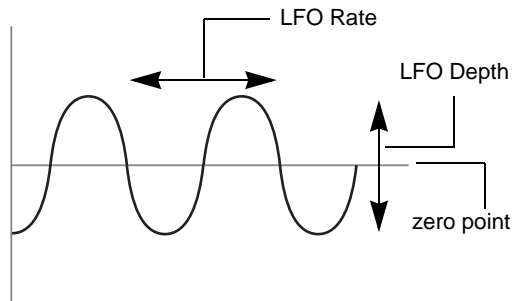

Operation with “Flange” Range setting (no offset)

ADT (Artificial Double Tracking) Range settings outside the narrow center band simulate *artificial double tracking*, in which the variable delay does not cross the “zero” point. This varying delay cre-

ates a unique doubling effect, essentially an analog precursor to chorusing. (You can hear ADT-type effects on many classic analog recordings, such as those of the Beatles or Led Zeppelin.)

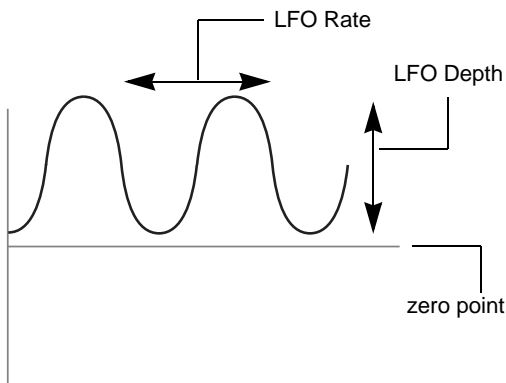

Operation with “ADT” Range setting (positive offset)



When the LFO Depth control is set to zero, you can still achieve a “manual” flanging or ADT effect by varying the Range control.

Feedback

The Feedback control adds a short delay to the flanged signal. Feedback amount is adjustable from 0 to 100 percent, with a default value of 0 percent. (This is not the same feedback effect as on an electronic flanger or delay.)

Wow/Flutter

The Wow/Flutter control adjusts the amplitude of the variable delay tape machine’s wow and flutter, or the amount of fluctuation in tape speed. A higher setting results in wider fluctuations in speed. A lower setting results in narrower fluctuations in speed. Wow/Flutter is adjustable from 0 to 1 percent, with a default value of 0.03 percent.

Rate

The LFO Rate control adjusts the rate of change in the variable delay. A higher setting results in faster fluctuations in speed. A lower setting results in slower fluctuations in speed. LFO Rate is adjustable from 0.05 Hz to 5 Hz, with a default setting of 0.14 Hz.

You can set the LFO Rate control to synchronize to the current tempo of the Pro Tools session. See “Synchronizing Reel Tape Flanger to Session Tempo” on page 241.

Depth

The LFO Depth control adjusts the amplitude of the change in variable delay. A higher setting results in wider fluctuations in speed. A lower setting results in narrower fluctuations in speed. LFO Depth is adjustable from 0 to 100 percent, with a default value of 65 percent.

Mix

The Mix control adjusts the amount of fixed delay signal mixed with the variable delay signal in the final output of the plug-in. The default Mix value is adjustable from –100 (all fixed delay signal) to +100 (all variable delay signal) percent, with a default value of 0 (50% fixed delay, 50% variable delay signals).

Invert

(Plug-In Automation Playlist or Control Surface Access Only)

The Invert parameter inverts the polarity of the signal coming from the variable delay tape machine, so that complete audio cancellation occurs when the flanger effect crosses the zero point. The default setting for the Invert parameter is Off.

This parameter is accessible only from the plug-in automation playlist or from a supported control surface.

 *Settings for this parameter are saved with plug-in presets. If you use a preset for the DSP, Native, or AudioSuite version of this plug-in, any settings for this parameter will be active.*

Noise

(Plug-In Automation Playlist or Control Surface Access Only)

The Noise parameter controls the level of simulated tape hiss that is added to the processed signal. Noise is adjustable from Off (–INF) to –24 dB, with a default value of Off.

This parameter is accessible only from the plug-in automation playlist or from a supported control surface.

 *Settings for this parameter are saved with plug-in presets. If you use a preset for the DSP, Native, or AudioSuite version of this plug-in, any settings for this parameter will be active.*

Synchronizing Reel Tape Flanger to Session Tempo

You can set the LFO Rate in Reel Tape Flanger to synchronize to the session tempo (in beats per minute).

To synchronize the LFO Rate control setting to the session tempo:

- 1 In the BPM Sync section, click the On button. The Tempo/Rate display changes to synchronize with the current session tempo.

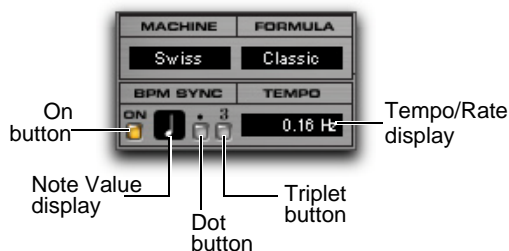

BPM Sync controls

- 2 To set a rhythmic LFO rate, click the Note Value to choose from the available note values (whole, half, quarter, eighth, sixteenth, or thirty-second note)
- 3 To adjust the rhythm further, do any of the following:
 - To enable triplet rhythm delay timing, click the Triplet (“3”) button so that it is lit.
 - To set a dotted rhythm delay value, click the Dot (“.”) button so that it is lit.

Reel Tape Flanger Tips

- ◆ To achieve a flanging effect, set the Range control within the “Flange” range and adjust the LFO Depth control to a value that is greater than the offset (so that the variable delay crosses the “zero” point.)
- ◆ To achieve an ADT (doubling) effect, set the Range control within either of the “ADT” ranges and adjust the LFO Depth control to a value that is smaller than the offset (so that the variable delay does not cross the “zero” point).
- ◆ To achieve a manual flanging effect, set the LFO Depth control to 0 and vary (or automate) the Range control within the “Flange” range. For fine control, hold Control (Windows) or Command (Mac) while varying the Range control.
- ◆ To add complexity to flanging or ADT effects, turn up the Wow/Flutter control to introduce more fluctuation in the variable delay.
- ◆ Use Reel Tape Flanger in a send/return configuration to mix the dry signal with an aggressively driven, flanged signal to control the amount of “grunge” in the final mix.
- ◆ When you start playback, the LFO sweep always starts at the bottom of the cycle, so each time you start playback from the same location (for example, at a bar line), the effect will be applied in the same way.

Reel Tape Flanger Presets

12-String Moderate-depth ADT setting that works well with acoustic guitar sounds

Flutter Flange Moderate-depth flange setting with Wow/Flutter

Flutter Extreme Wow/Flutter setting with flanging turned off and a Mix setting that passes only the variable delay

Manual Flange Settings with LFO Depth set to zero, ready for manual flanging by adjusting or automating the Range control

Slow Flange High Depth setting combined with slow LFO Rate, suitable for flanging vocals

Vocal ADT Settings for creating doubling effect without flanging “crossover” effect, suitable for vocals

Vocal Walrus Drive-boosted settings for extreme vocal doubling effect

Wobble A high LFO Rate setting combined with a Mix setting that passes only the variable delay. Works well on sustained parts.

Chapter 41: Sci-Fi

Sci-Fi features analog synthesizer-type effects that include:

- Ring modulation
- Frequency modulation
- Variable-frequency, positive and negative resonator
- Modulation control by LFO, envelope follower, sample-and-hold, or trigger-and-hold

Sci-Fi is available in DSP, Native, and AudioSuite formats.

Sci-Fi supports 44.1 kHz, 48 kHz, 88.2 kHz, 96 kHz, 176.4 kHz and 192 kHz sample rates.

Sci-Fi operates as a mono, multi-mono, or stereo plug-in.



Sci-Fi

Sci-Fi is designed to mock-synthesize audio by adding effects such as ring modulation, resonation, and sample & hold, which are typically found on older, modular analog synthesizers. Sci-Fi is ideal for adding a synth edge to a track.

Sci-Fi Controls

Sci-Fi Input Level

Input Level attenuates signal input level to the Sci-Fi processor. Since some Sci-Fi controls (such as Resonator) can cause extreme changes in signal level, adjusting the Input Level is particularly useful for achieving unity gain with the original signal level. The range of this control is from -12 dB to 0 dB.

Sci-Fi Effect Types

Sci-Fi provides four different types of effects:

Ring Mod Is a ring modulator—which modulates the signal amplitude with a carrier frequency, producing harmonic sidebands that are the sum and difference of the frequencies of the two signals. The carrier frequency is supplied by Sci-Fi itself. The modulation frequency is determined by the Effect Frequency control. Ring modulation adds a characteristic hard-edged, metallic sound to audio.

Freak Mod Is a frequency modulation processor that modulates the signal frequency with a carrier frequency, producing harmonic sidebands that are the sum and difference of the input signal frequency and whole number multiples of the carrier frequency. Frequency modulation produces many more sideband frequencies than ring modulation and an even wilder metallic characteristic. The Effect Frequency control determines the modulation frequency of the Freak Mod effect.

Resonator+ and Resonator– Add a resonant frequency tone to the audio signal. This frequency is determined by the Effect Frequency control. The difference between these two modules is that Resonator– reverses the phase (polarity) of the effect, producing a hollower sound than Resonator+. The Resonator can be used to produce metallic and flanging effects that emulate the sound of classic analog flangers.

Sci-Fi Effect Amount

Effect Amount controls the mix of the processed sound with the original signal. The range of this control is from 0–100%.

Sci-Fi Effect Frequency

Effect Frequency controls the modulation frequency of the ring modulator and resonators. The frequency range is dependent on the effect type. For Ring Mod, the frequency range of this control is from 0 Hz to 22.05 kHz. For Freak Mod, the frequency range is from 0 Hz to 22.05 kHz. For Resonator+, the frequency range is from 344 to 11.025 kHz. For Resonator–, the frequency range is from 172 Hz to 5.5 kHz.

You can also enter a frequency value using keyboard note entry.

Sci-Fi Mod Type Controls

The four Mod Type buttons determine the type of modulation applied to the frequency of the selected effect. Depending on the type of modulation you select here, the sliders below it will change to provide the appropriate type of modulation controls. If the Mod Amount is set to 0%, no dynamic modulation is applied to the audio signal. The Effect Frequency slider then becomes the primary control for modifying the sound.

LFO Produces a low-frequency triangle wave as a modulation source. The rate and amplitude of the triangle wave are determined by the Mod Rate and Mod Amount controls, respectively.

Envelope Follower Causes the selected effect to dynamically track the input signal by varying with the amplitude envelope of the audio signal. As the signal gets louder, more modulation occurs. This can be used to produce a very good automatic wah-wah-type effect. When you select the Envelope Follower, the Mod Amount slider changes to a Mod Slewing control. Slewing provides you with the ability to smooth out extreme dynamic changes in your modulation source. This provides a smoother, more continuous modulation effect. The more slewing you add, the more gradual the changes in modulation will be.

Sample+Hold Periodically samples a random pseudo-noise signal and applies it to the effect frequency. Sample and hold modulation produces a characteristic random stair-step modulation. The sampling rate and the amplitude are determined by the Mod Rate and Mod Amount controls, respectively.

Trigger+Hold Trigger and hold modulation is similar to sample and hold modulation, with one significant difference: If the input signal falls below the threshold set with the Mod Threshold control, modulation will not occur. This provides interesting rhythmic effects, where modulation occurs primarily on signal peaks. Modulation will occur in a periodic, yet random way that varies directly with peaks in the audio material. Think of this type of modulation as having the best elements of both sample and hold modulation and with an envelope follower.

Sci-Fi Mod Amount and Mod Rate Controls

These two sliders control the amplitude and frequency of the modulating signal. The modulation amount ranges from 0% to 100%. The modulation rate, when LFO or Sample+Hold are selected, ranges from 0.1 Hz to 20 Hz.

If you select Trigger+Hold as a modulation type, the Mod Rate slider changes to a Mod Threshold slider, which is adjustable from -95 dB to 0 dB. It determines the level above which modulation occurs with the trigger and hold function.

If you select Envelope Follower as a modulation type, the Mod Rate slider changes to a Mod Slew-ing slider, which is adjustable from 0% to 100%.

Sci-Fi Output Meter

The Output Meter indicates the output level of the processed signal. Note that this meter indicates the output level of the signal—not the input level. If this meter clips, the signal may have clipped on input before it reached Sci-Fi. Monitor your send or insert signal levels closely to prevent this from happening.

Chapter 42: Voce Plug-Ins

The Voce plug-ins provide a pair of vintage modulation effect plug-ins: Voce Chorus Vibrato and Voce Spin.

The Voce plug-ins are available in DSP, Native, and AudioSuite formats.

The Voce plug-ins support 44.1 kHz, 48 kHz, 88.2 kHz, 96 kHz, 176.4 kHz, and 192 kHz sample rates.

The Voce plug-ins support mono, mono-to-stereo (Voce Spin only), multi-mono, and stereo operation.

Voce Chorus/Vibrato

Voce Chorus/Vibrato recreates the mechanical scanner vibrato found in the B-3 Organ. Three settings of chorus and three settings of vibrato presented on one cool knob! Fun and easy to use, it's a classic effect used for over sixty years.



Voce Chorus/Vibrato

In a large pipe organ, “ranks” of pipes (multiple pipes designed to emit the same frequency) aren’t perfectly in tune. The effect goes by the name “multirank” or, more commonly, “chorus.”

Inside every B3 organ, on the end of the driveshaft that spins the tonewheels, you’ll find a mechanical contraption that delays the sound of the organ. Originally added to make the B3 sound more like a pipe organ, it imparts frequency variation to the sound.

Although well received by churches, the signature B-3 Chorus/Vibrato graced jazz and rock recordings ever since. Now you can use this beautiful effect on any instrument.

Voce Chorus/Vibrato Controls

Simply click the Big Knob to rotate between settings of Vibrato and Chorus. V1 provides the least amount of vibrato, V2 slightly more, and V3 the most. Likewise the amount of Chorus increases from C1 to C3.

Option-click (Mac) or Alt-click (Windows) the knob to rotate it in the opposite direction, or click the lettering to select a specific setting.

Voce Chorus/Vibrato Tips and Tricks

The classic setting for organ is “C3” but you’ll find other settings useful on a variety of instruments. Some of our favorites include:

Electric Pianos

Many electric pianos feature built-in vibrato. But if the sound you’re using doesn’t provide a realistic vibrato (perhaps you’re wrestling with a sampler), track dry and apply the effect later.

Guitar

A certain popular guitar amp has a knob that says “Vibrato” but it’s really just Tremolo. Tremolo is amplitude modulation; the sound gets louder and quieter. Vibrato, in contrast, imparts pitch change. A select few highly sought after ‘50s Magnatone guitar amps feature a true tube vibrato (one even does stereo!) You can approximate this sound by recording guitar direct (or starting with a clean miked sound), applying Voce Chorus/Vibrato, then using SansAmp™ PSA-1 or Eleven.

Voce Spin

Voce Spin provides the most accurate simulation of the well-loved rotating speaker. 15 classic recording setups feature horn resonance, speaker crossover, varying microphone placement—even the “Memphis” sound with the lower drum’s slow motor unplugged!



Voce Spin

Don Leslie invented the rotating speaker in 1937. His design is simple and elegant: an internal 40-watt tube amplifier feeds a speaker crossover, which splits the signal.

All frequencies below 800 Hz go to a 15” bass speaker and all frequencies above 800 Hz go to a compression horn driver.

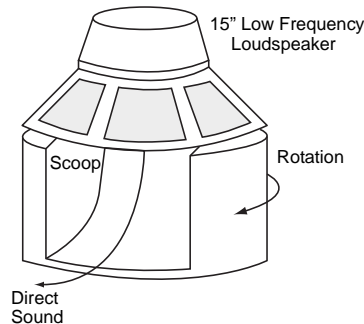

Lower speaker assembly

The large bass speaker is bolted to the cabinet and a foam drum directly below the speaker reflects the bass outward.

For the high frequencies, a treble horn with two bells reflects the sound from the compression horn driver located below.

Only one bell actually produces sound; the other is merely a counterbalance.

Then, of course, it spins. Separate belts, pulleys and motors drive the upper treble horn and the lower foam drum. Adding to the effect, the upper horn and lower drum spin in opposite directions. Most rotating speakers feature two sets of motors, allowing both slow (“Chorale”) and fast (“Tremolo”) rotation speeds.

Voce Spin Controls

Of course, all that motion creates a rich sound—but then you have to capture it using microphones. Spin provides fifteen classic recording setups to choose from, giving you the sounds you’ve heard on countless records instantly.

Just choose a preset and click Chorale, Tremolo, or Off. Alternately, click and drag the flip switch. Short flicks of the wrist land on Off; longer flicks toggle between Chorale and Tremolo.



See also “Voce Spin Additional Controls” on page 248.

You may also Alt-click (Windows) or Option-click (Mac) anywhere to toggle between Chorale and Tremolo speeds.

Spin Presets

122 Model 122 speaker, medium pulleys.

122 (Small Pulley) Small pulleys (fastest rotation).

122 (Large Pulley) Large pulleys (slowest rotation).

122 (Wide Stereo) Middle pulleys, wide stereo microphone placement.

122 (Mono) Middle pulleys, one mic each top and bottom.

21H Model 21H speaker.

Foam Drum Middle pulleys, microphones close.

Memphis Lower drum slow motor unplugged, microphones close.

Steppenwolf Lower drum only, loose belts, microphones close.

Rover (Slow to Fast) Guitar rotating speaker, maximum speed differential.

Rover (Slow to Medium) Guitar rotating speaker, slower variation.

Rover (Medium to Fast) Guitar rotating speaker, faster variation.

Phaser Medium rotation rate, microphones very close.

Watery Guitar Fast rotation rate, microphones close.

Speed Options

Chorale Slow rotation.

Tremolo Fast rotation.

Off No rotation, but still through the crossover and speakers (wherever the speakers comes to rest relative to the microphones!).

Voce Spin Additional Controls

Though the Voce Spin plug-in window contains only the Chorale/Off/Tremolo control, the following controls are also available:

- Input Trim
- Speed Switch
- Rotor Balance
- Upper Slow Speed
- Upper Accel Rate
- Upper Decel Rate
- Upper Mic Angle
- Lower Fast Speed

- Lower Slow Speed
- Lower Accel Rate
- Lower Decel Rate
- Lower Mic Angle

You can adjust and automate controls such as input trim (from -24 dB to $+24$ dB), set the rotor balance (the mix between the upper and lower speakers), specify acceleration and deceleration times (in seconds) for both the upper and lower speakers, tweak the fast and slow speeds of each speaker, and specify the microphone angle for each stereo pair of microphones.

You can access these additional controls through Pro Tools plug-in automation, and/or from a compatible control surface.

Accessing Voce Spin Controls

Accessing Voce Spin Controls On-Screen

All Voce Spin controls can be adjusted on-screen by editing Pro Tools breakpoint automation data.

To access additional Voce Spin controls on-screen:

- 1 Click the Plug-In Automation button in the Plug-In window to open the Plug-In Automation window.
- 2 In the list of controls at the left, click to select a control and click Add (or just double-click a control in the list). Repeat to access and enable additional controls.
- 3 Click OK to close the Plug-In Automation window.

- 4 In the Edit window, do one of the following:
 - Click the Track View selector and select the automation control you just enabled from the Voce Spin sub-menu.
 - Reveal an Automation lane for the track, click the Automation Type selector and select the automation control you just enabled from the Voce Spin sub-menu.
- 5 Edit the breakpoint automation for the enabled control.

Accessing Voce Spin Controls on a Control Surface

When using a control surface, all Voce Spin controls are available whenever the plug-in is focused. You only need to enable plug-in automation if you want to record your adjustments as breakpoint automation.

To access additional Voce controls from a control surface:

- 1 Focus the Voce Spin plug-in on your control surface. All available controls are mapped to encoders, faders, and switches.
- 2 Adjust the corresponding control.
- 3 Use the previous/next Page controls to access additional controls.



To automate your adjustments, enable automation for that control. For more information on plug-in automation, see the Pro Tools Reference Guide.

Voce Spin Tips and Tricks

The “One Mic Way Back In The Corner Of The Room” Trick

Spin isn’t designed to sound like a rotating speaker spinning all by itself in a large room. Spin provides the sound of a miked rotating speaker, the sound the producer and engineer hear in the control room. But don’t let that stop you from getting the sound you want!

To achieve the sound of a distant microphone capturing the rotating speaker, run Spin using the wide stereo preset. Now apply a room reverb, remove any pre-delay, and adjust the wet/dry reverb balance until you get the distant sound you’re looking for.

Spin into Moogerfooger Lowpass Filter

Try using the amplitude modulation effects of Spin as an LFO driving the Moogerfooger Lowpass Filter!

Distortion and Spin

To simulate overdriving the tube amp powering the rotating speaker, apply distortion before Spin, since, in the real-world signal path, the amp distorts the signal before the speakers throw the sound around. Among tons of other great distortion sounds, the SansAmp PSA-1 plug-in provides distortion presets for both the model 122 and model 147 rotating speakers.

Organ Signal Path

Likewise, when going for classic organ sounds, route through the Voce Chorus/Vibrato before Spin, as that’s the signal path in the B-3 organ.

The John Lennon Vocal Thing

In what seems like a particularly dangerous Beatles studio experiment, a Leslie speaker cabinet was dismembered, a microphone was affixed to the rapidly spinning upper rotor, and John Lennon attempted to sing into it. Fortunately the deafening wind noise captured by the microphone put a stop to the proceedings before anyone was hurt. Feel free just to run the vocal through the rotating speaker—that’s what they wound up doing.

Reverse Spin

Those reverse-vocal and reverse-guitar tricks are even more fun when you run ‘em through Spin. Try reversing the vocal and putting it through Spin, as well as putting the vocal through Spin then reversing the processed vocal.

Generator Leakage

Of all the sounds to pass through a Leslie, no sound has been amplified more often than the sound of B3 Organ generator leakage. Even with no notes keyed, a small amount of B3 sound leaks out.

Part VIII: Harmonic Plug-Ins

Chapter 43: Aphex Aural Exciter Type III

Aural Exciter Type III is an AAX plug-in that retains the look and sound of Aphex Systems' renowned hardware units. Aural Exciter makes it possible to recreate and restore missing harmonics.



Aphex Aural Exciter, Type III

Aphex Systems, Inc. first introduced Aural Exciter in 1975. Since then, several refinements and improvements have been incorporated into its original design. The Aural Exciter plug-in is modeled after the TYPE III Aural Exciter. Aural Exciter has become a standard in the professional audio industry, and has been used on many albums, CDs, movies, broadcast productions, commercials, and concerts. The Aural Exciter plug-in for Pro Tools continues this tradition of success, and is ready for use with the latest cutting edge music productions.

Harmonics are musically and dynamically related to the original sound, and reveal the fine differences between voices and various instruments. Reproduced sound is audibly different from the original live sound because of the loss in harmonic detail, often sounding dull and lifeless.

Aural Exciter is an audio process that recreates and restores missing harmonics. It actually adds harmonics, restoring the sound's natural brightness, clarity and presence, effectively improving detail and intelligibility. Use Aural Exciter on specific instruments or in the final mix to bring life back to recordings.

Unlike EQs and other brightness enhancers which only boost the high frequencies that often alter the overall tonal balance, Aural Exciter extends the high frequencies. The stereo image is enhanced with Aural Exciter. This results in a greater perceived loudness without an introduction of noise into the audio path, commonly caused by increased gain.

Aural Exciter is a single-ended process which can be inserted at any point within the audio chain. The input signal is split into two paths. One path goes to the output unmodified, while the other path, known as a side-chain, goes through the Aural Exciter, which includes a tunable high-pass filter and a harmonics generator. Aural Exciter applies frequency-dependent phase shift and amplitude-dependent harmonics. The output of the Aural Exciter's harmonic generator is mixed back with the unmodified signal, lower in level.

When used at nominal settings, Aural Exciter does not add significant average level to the original signal. Even though the added information is low level, the perception is a dramatic increase in mid and high frequencies.

The Aural Exciter is patented in the United States, Japan and most of Europe. Others may claim they are doing the same thing, but they can only resort to some form of EQ (amplitude correction or expansion), phase scrambling and/or filtering. They can only increase peak levels causing clipping, feedback, tape distortion and listener fatigue.

Aural Exciter is available in DSP, Native, and AudioSuite formats.

Aural Exciter supports 44.1 kHz, 48 kHz, 88.2 kHz, 96 kHz, 176.4 kHz and 192 kHz sample rates.

Aural Exciter operates as a mono, multi-mono, or stereo plug-in.

BLOCK DIAGRAM OF AURAL EXCITER TYPE III

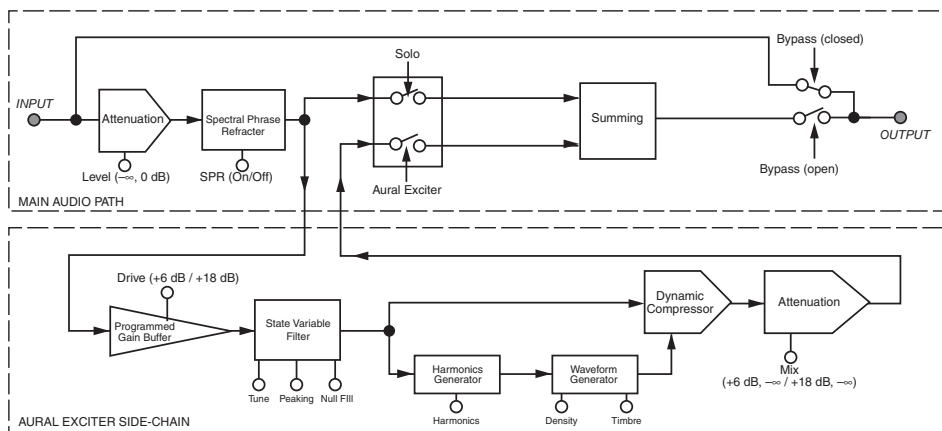

Block Diagram of Aphex Aural Exciter, Type III

Meters

Drive Meter

The Drive meter monitors the peak level to the harmonic generator. It works in conjunction with the Drive switch.

For optimal performance keep the peak hold meter of the Drive meter inside the yellow area. The harder you drive the Exciter, the more Exciter enhancement you generate. If you cannot get the Drive meter to register in the yellow area, try setting the Drive switch to High (Drive switch enabled).

Out Meter

The Out meter lets you monitor the output level after Aural Exciter processing.

Rotary Controls

Level Control

The Level control sets the attenuation of the input signal. For normal operation set the Level control on Max (no attenuation).

Aural Exciter has an internal gain structure that boosts +6 dB of the output from the high-pass filter into the side-chain. The Drive switch further boosts the signal level fed into the harmonics generator. When Drive is set to Normal, you obtain a boost of +6 dB; in the High position you can get an additional 6 dB of gain, for a total maximum boost of +18 dB. You can also generate a boost in the high-pass filter section by setting Peaking to Max.

If you run into headroom problems when adjusting the Mix control, adjust the Level control to generate the necessary headroom.

Tune Control

The Tune control sets the bandwidth (corner frequency) of the second order high-pass filter in the side-chain prior to the harmonics generator. The range of the control extends from 700 Hz to 7 kHz. The following figure shows the range of the Tune control from 700 Hz to 7 kHz with Null Fill set near Min and Peaking set at the mid-point position.

Notice the interaction that the Peaking and Null Fill controls have on Tune, as well as on each other.

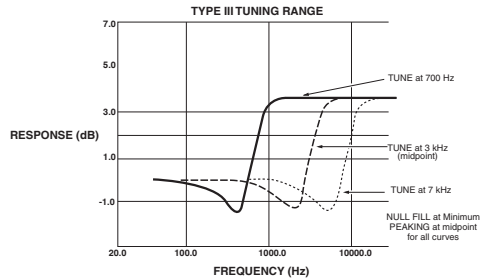

Tune control

Peaking Control

The Peaking control provides a damping effect on the leading frequency edge of the high-pass filter controlled by Tune. As you vary this control from Min to Max, the Tune frequency becomes more accentuated, as shown in the following figure. However, at the same time, a dip is created just before the accentuated Tune frequency. This dip or null becomes larger as Peaking is increased.

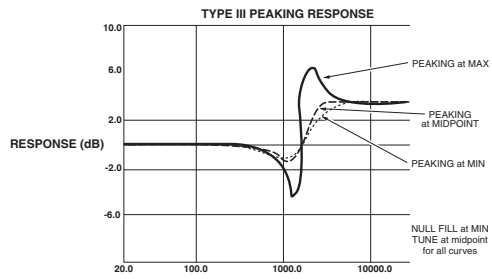

Peaking control

The amount of Peaking is displayed as a percentage.

Null Fill Control

The Null Fill control adjusts the curve of the high-pass filter to “fill in” the null caused by the summing of the side-chain return signal and the input signal.

The amount of Null Fill is displayed as a percentage.

This control compensates for “phase pulling,” which occurs as a side effect of the time delay present in the side-chain signal, an important part of the Aural Exciter operating theory. As the time delay “stretches” transient waveforms to create a perception of louder sound, a “dip” or “null” also occurs in the output equalization curve at the Tune frequency. As a result, the “null” frequencies are deemphasized, thus giving even more emphasis to the higher frequencies. Although this often is a desirable effect, the Null Fill control was created to allow the user to fill-in the null by a selectable amount for any applications requiring less emphasis.

The following figure shows three different Null Fill settings with Tune set at the mid-point position.

With the Null Fill control set at Min, there is a noticeable drop in the frequency response, just before the start of the high-pass shelf boost. At this setting, program material under enhancement would lose some presence. When the Null Fill control is set at Max, the frequency dip is filled, but the frequencies associated with the shelf top become accentuated. Also notice the shift in the Tune frequency (0 dB axis) for the range of Null Fill settings.

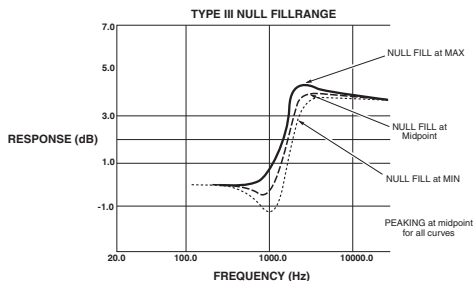

Null Fill control

Harmonics Control

The Harmonics control adjusts the amount of harmonics being generated, which is displayed as a percentage underneath the controls.

The harmonic generator produces harmonic components according to a complex set of laws, including considerations for transient and steady-state qualities, as well as relative amplitude of the original audio signal.

As you move the control up, harmonic content increases proportionally as it works in conjunction with the Timbre control. Moreover, the amount of harmonics generated is dependent on the input level. The gain of the harmonics automatically increases as the input level increases.

The generated harmonics are not products of harmonic distortion, since they are intelligently produced and formed into a power envelope that enhances rather than distorts the final audio signal.

Timbre Control

The Timbre control sets the order or type of harmonic signal being generated by way of the Harmonics control. The control can be varied from all Even harmonics in the Min position, to all Odd harmonics at the Max position. Odd order harmonics will sound softer to your ear, while even harmonics will sound harsher.

Varying the Timbre control between the two extremes will provide you with a mix of both Even and Odd harmonics in proportion to the control position. To emphasize the effect of the Timbre control, set the Density switch to High.

The Timbre control display ranges from +100% (all Odd) to -100% (all Even).

Mix Control

The Mix control determines the amount of Aural Exciter enhancement mixed into the original signal. The control ranges from Min (no enhancement), up to Max, representing approximately a 6 dB boost when the Drive switch is set to Normal, and approximately an 18 dB boost when it is set to High.

The amount of enhancement mixed into the original signal is displayed as a percentage.

Switches

Drive Switch

The Drive switch offers two settings, Normal (+6 dB) and High (+18 dB). This sets the input sensitivity to the harmonics generator. In general, this switch will be left in the Normal position. However, weak signals may require more gain, in which case you should place this switch in the High position.

Use the Drive meter to determine if the signal gain needs to be increased. When the meter level stays in the green area (never rising into the yellow area), then the input signal is too low. Raise the input sensitivity by toggling the Drive switch to High.

The switch illuminates when Drive is set to High.

Density Switch

The Density switch determines the amount of harmonics generated by choosing one of two different harmonics generator algorithms. When set on High, the output from the harmonic generator expands low level signals and compresses the highest peaks. This setting provides a higher density of harmonics with better control of peak levels.

Since the amount of harmonics is dependent on the input level, start with the switch set to Normal. Switch to High if you still want a greater density of harmonics after the input level is set.

The switch illuminates when Density is set to High.

Ax Switch

The Ax switch gives you the choice of turning the Aural Excitement process On or Off. The Ax switch illuminates when Ax is engaged, confirming that the effect is On.

Unlike the Bypass switch, the audio signal from the input does travel through the processing algorithm on the way to the output whenever Ax is Off. This means that the SPR effect can still be active, by switching Ax Off and SPR On.

Solo Switch

When engaged, the Solo switch gives you a choice of auditioning the Aural Excitement signal without the main audio. The switch illuminates when Solo is active.

As an application for the Solo switch, select Solo to return the pure effect back to the mixing console for precise memory control of the Aural Excitement signal only.

SPR Switch

The SPR switch controls the Spectral Phase Refractor effect. This effect is independent of all other controls or switches, except Bypass. The switch illuminates when SPR is engaged, confirming that SPR is On. SPR processes the main audio signal in such a way that bass frequencies (up to 150 Hz) lead phase in relation to the rest of the spectrum.

Through the many steps of recording, duplicating, distributing, and reproducing sound, the phase of the low frequency audio spectrum becomes delayed compared to mid and high frequencies. SPR corrects the bass delay anomaly to restore clarity and openness and significantly increases the apparent bass energy level without adding any amplitude equalization or bass boost.

To audition the effect of SPR on the audio signal, turn the Ax switch Off and turn SPR On. Then alternately turn the Bypass switch On and Off to hear the SPR effect on incoming audio.

The SPR function is shown in the following figure, which shows the frequency dependent time delay that is produced. Note that this is not the same as a group delay. Group delay is a constant time delay at all frequencies.

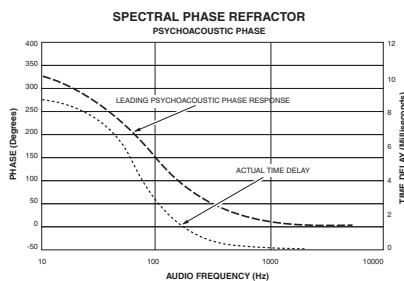

SPR switch

Bypass Switch

The Bypass switch allows the main audio signal to bypass the Aural Exciter plug-in completely.

The indicator switch illuminates when Bypass is engaged.

The Bypass switch on the plug-in provides the same function as the Bypass button in the Pro Tools Plug-In window, on a per-channel basis.

Link Switch

The Link switch is for stereo operation only. It links the left and right controls so they work as one. Grab the control on one page with the cursor and move it to the required position. The control on the other page automatically updates. In this way both controls can be set to the exact same position. Stereo controls may be linked temporarily by holding down the Shift key while adjusting the control.

The switch illuminates when Link is activated.

LR (Left/Right) Switches

The LR switch is for stereo operation only. It allows you to view or change parameters on one channel at a time.

The switch for the currently displayed channel illuminates.

To edit both channels simultaneously, click the Link switch.

Using Aural Exciter III

In the recording studio, post production suite, or similar environment, post-processing of previously recorded audio tracks with Aural Exciter can restore lost vibrancy and realism, even to the extent of saving dialogue or sound effects which were thought to be unusable. Instruments and vocals can be made to stand out in the mix without substantially increasing the mix levels or using equalization.

The Pro Tools mixing environment is very flexible, offering several ways to route and use Aural Exciter in a session. This section provides some suggestions for efficient use of Aural Exciter in your Pro Tools sessions. The exact steps you take to use Aural Exciter's capabilities will differ depending on the nature of your session and your specific Pro Tools mixer configuration.

Setting the Gain Structure

If the input material has a very high peak-to-peak level and no additional headroom for Exciter effects, use the Level fader to adjust the signal level to avoid over-coloring the signal.

When using digital audio as a sound source, such as a CD Player with S/PDIF outputs, there is a very high peak-to-peak level because the material on the CD is optimized for the best signal-to-noise performance. In this situation the Level fader can be used to adjust the signal level to gain additional headroom.

In an analog based system you will have the same headroom problem when using a very high peak-to-peak level signal.

Using the Level fader to adjust for more headroom is also useful when restoring older recordings.

For optimal performance keep the peak hold meter of the Drive meter inside the yellow area. The harder you drive the Exciter, the more Exciter enhancement you generate. If you cannot get the Drive meter to register in the yellow area, try setting the Drive switch to High.

Optimizing Aural Exciter Effects

When using Aural Exciter, the output signal level has to be equal to the input signal level plus the enhanced Exciter effect. The dynamic characteristics of the harmonic generator used in the Aural Exciter plug-in are based on a complex algorithm that includes the signal peak level, the averaged steady state level, and the dynamic characteristics.

Unlike an EQ, which adds a constant boost in the high end, Aural Exciter enhancement is added into the input signal in such a way that the average signal level will be virtually unchanged.

The Level, Tune, Peaking, Null Fill, Harmonics, Timbre and Mix faders provide separate left and right faders when in stereo. For stereo, a separate set of switches for independent control of the left and right channels is provided for Ax, Solo, SPR, Bypass, Drive and Density.

The Tune fader adjusts the corner frequency of the high pass filter and the Mix fader varies the amount of Aural Exciter enhancement that is mixed with the unmodified signal.

Experiment with the Aural Exciter controls to hear how each one enhances the original audio signal.

To experiment with Aural Exciter:

- 1 Set the Level fader on Max.
- 2 Set the Drive switch to reflect the current nominal level.
- 3 Make sure the Bypass switch is deactivated (Bypass light off).
- 4 Make sure the Ax switch is activated (Ax light on).
- 5 Set Density to Normal. (Density light off). As you make the following adjustments, alternate the Density switch between Normal and High to hear the change in the Aural Exciter effect.
- 6 Put the Aural Exciter Mix fader on Max, making it easier to hear the effect as it changes.
- 7 Vary the Tune fader and listen for the frequency range that is being enhanced. The Tune fader can be used to enhance a particular instrument so it stands out in the mix.
- 8 Adjust the Harmonics fader and listen for the change in harmonics being added to the original audio signal.
- 9 When finished experimenting, set the Mix control to taste. Keep in mind that a little Aural Exciter goes a long way.

Using the Tune Fader

After a while you'll get a sense of where you like your Tune setting when using Aural Exciter on individual tracks. It's best not to process the same range of frequencies with the Tune fader during the final mix. If you already processed individual tracks with Aural Exciter, try starting the final mix with the Tune fader in the maximum position which is approximately 7 kHz. You should get a spacious, three-dimensional mix with an open "airy" quality.

Using the SPR Switch

The SPR function can produce a useful effect with solo voices (human and instrumental) or mixed programs (such as drama and music). There is no specific time when SPR should or shouldn't be used. Experiment with it on various types of material until you get used to the effect. Listen carefully as you operate the SPR switch. The effect may be noticed only at certain times (such as specific modulations of a voice or during a particular instrumental playing style or passage). Don't expect to hear the sound change radically. The SPR is usually subtle, adding a certain beauty and good feeling to the sound. In time you will find that the SPR does indeed produce demonstrable results.

For instance, the SPR effect can:

- Drop pitch of ultra low bass
- Increase apparent bass power
- Unmask instruments or sonic details hidden in the mix
- Improve definition of high frequency sounds (such as on cymbals and bells)
- Improve speech articulation and presence
- Increase depth and clarity of male voices

Successful use of the SPR depends on the character of the original sound. It is hard to predict in advance what will be the effect of the SPR. Typically, you may find it useful about 50% of the time. At other times, there will be little or no discernible effect. Seldom does the effect damage good audio, so it could be left on as a matter of course.

A few examples of audio material likely to be helped by the SPR are:

- Highly overdubbed tape tracks
- Live acoustic recordings
- Electronic keyboards
- Productions composed from tape cartridge and cassette sources
- Material recorded with transformer coupled mic preamps
- Vocals recorded with dynamic microphones
- Reverberant live sound or recordings
- Highly equalized material
- Delayed, flanged, or digitally processed material
- Material from broadcast audio reception (such as store casting and muzak)

Chapter 44: Aphex Big Bottom Pro

Aphex Big Bottom Pro is an AAX plug-in that retains the look and sound of Aphex Systems' renowned hardware units. Aphex Systems, Inc. first introduced Big Bottom Pro in 1992 as part of the Model 104. Since then, Big Bottom Pro has become a standard in the professional audio industry, and has been used on numerous albums, CDs, movies, broadcast productions, commercials, and concerts. The Big Bottom Pro plug-in for Pro Tools continues this tradition of success, and is ready for use with the latest cutting edge music productions.



Aphex Big Bottom Pro

Big Bottom Pro provides more energy to the bass (increasing its sustain and density). It dynamically contours the bass response of a complex range of shapes in the 40 to 400 Hz range, isolating and enhancing the lowest frequencies to provide a deeper, more resonant bass. Big Bottom increases the perception of low frequencies without significantly increasing the maximum peak output.

Big Bottom Pro is a single-ended process which can be inserted at any point within the audio chain. The input signal is split into two parts. One part goes to the output unmodified, while the other part, known as a side-chain, goes through Big Bottom Pro. The side-chain consists of a tunable low pass filter followed by a dynamic processor.

Big Bottom is available in DSP, Native, and Audio-Suite formats.

Big Bottom supports 44.1 kHz, 48 kHz, 88.2 kHz, 96 kHz, 176.4 kHz and 192 kHz sample rates.

Big Bottom Pro operates as a mono, multi-mono, or stereo plug-in.

BLOCK DIAGRAM OF BIG BOTTOM PRO

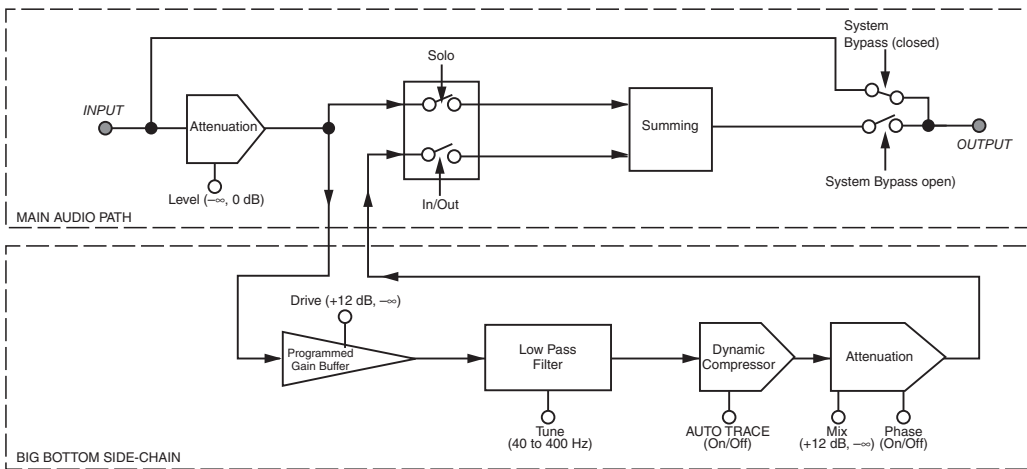

Block Diagram of Aphex Big Bottom Pro

Meters

Drive Meter

The input Drive peak meter indicates the actual peak level to the Big Bottom Pro side-chain.

Compression Meter

The Compression (Comp) meter indicates the actual amount of compression taking place in the Big Bottom Pro side-chain. If the Comp meter is not showing any activity the input level is too low. Adjust the Level and Drive controls accordingly.

Out Meter

The Output peak meter indicates the actual peak level after mixing the Big Bottom Pro side-chain with the original input signal.



Audition the loudest or peak sections of your audio material to avoid Big Bottom Pro output clipping: Use the Out Meter to check for clipping.

Rotary Controls

Level Control

The Level control sets the attenuation of the input signal. For normal operation set the Level control on Max (0 dB).

In the event you are not generating enough bass enhancement (even when the Mix control is also set on Max), lower the Level control. This will give the plug-in more headroom by generating less compression in the dynamic processor, resulting in a more powerful side-chain signal. If you need more headroom when adjusting the Mix control, lower the input Level and re-tune the Mix control.

Drive Control

The Drive control sets the sensitivity to the bass generating side-chain. The corresponding Drive meter shows the actual peak level of the side-chain input. There is a boost in the side-chain signal of +12 dB, when the Drive control is set to Max.

The Drive control needs to be set at a point where the dynamic processor receives the optimum level required for Big Bottom Pro to work effectively. To find the optimum level, adjust the Drive control until the Comp meter displays in the yellow area. Make sure the Drive meter does not indicate clipping.

If the Comp meter is not showing any activity, the input level is too low. Adjust the Level control accordingly. When the AutoTrace switch is set to the On position, the setting of the Drive control is less sensitive, and the Big Bottom Pro side-chain affects a wider input range.

In general, higher Drive settings to the side-chain provide better control over peaks, while lower Drive settings tend to produce a more open sound.

By adjusting both the Drive and Mix controls, you can experiment with the different “colors” or timbral modifications Big Bottom Pro is able to generate.

Tune Control

The Tune control sets the bandwidth (corner frequency) of the low pass filter in the side-chain prior to the dynamics processor. The range of the Tune control is from 40–400 Hz.

Aside from the Mix control, this is the most important control on the Big Bottom Pro plug-in.

The Tune control is used to isolate the range of frequencies being enhanced by Big Bottom Pro.

Mix Control

The Mix control adjusts the amount of the Big Bottom Pro enhancement signal being added to the original signal. The lower the setting the subtler the effect. The higher the setting, the more dramatic the effect. It’s important to note that higher settings may increase the peak output.

Switches

In/Out Switch

The In/Out switch gives you the choice of turning the Big Bottom Pro process On or Off. When the switch is set to the On position, Big Bottom Pro enhancement is sent to the outputs.

The switch illuminates when the Big Bottom Pro effect is activated.

Unlike system bypass, the audio from the input travels through the DSP algorithm on the way to the output whenever the In/Out switch is set to Off.

Switching back and forth from On to Off provides a quick A/B comparison, allowing you to hear the enhancements from the Big Bottom Pro effect in your program content.

Solo Switch

When engaged, the Solo switch allows you to audition the Big Bottom Pro side-chain effect without the main audio signal. The switch illuminates when the Solo switch is activated.

Phase Switch

The Phase switch allows you to alter the phase of the side-chain signal, which contains the Big Bottom Pro effect, before it is mixed with the original input signal. This function is used as an optional way to change the “quality” of the Big Bottom Pro effect.

The switch illuminates when the Phase switch is activated.

Altering the side-chain signal’s phase dramatically effects the sound of the Big Bottom Pro enhancement. With the Phase switch turned Off, you will recognize the Big Bottom Pro effect found in the Aphex Model 104.

As an exclusive feature for this DSP plug-in, we have added the Phase switch. When activated, the Phase switch alters the Big Bottom Pro effect by setting the side-chain in-phase with the main signal. This increases the output peak level. Use the Mix or Level controls to restore the output peak level if the Drive meter indicates clipping.

AutoTrace Switch

Activating the AutoTrace switch enables an automatic threshold function for the compressor within the Big Bottom Pro side-chain. The AutoTrace function enables the dynamic processor to self-optimize during normal operation. The switch illuminates when the AutoTrace switch is activated.

This control is particularly useful when you want a subtle Big Bottom Pro effect, or when the peak level of the input material varies over time. The AutoTrace feature is also ideal for changing the sound characteristics of the Big Bottom Pro effect. Drive control adjustments will be reduced when the AutoTrace switch is activated.

Link Switch

The Link switch is for stereo operation only. It links the left and right controls so they work as one. Grab a control on one page with the cursor and move it to the desired position. The control on the other page automatically updates. In this way both controls can be set to the exact same position. Stereo controls may be linked temporarily by holding down the Shift key while adjusting the control.

The switch illuminates when Link is activated.

LR (Left/Right) Switches

The LR switch is for stereo operation only. It allows you to view or change parameters on one channel at a time.

The switch for the currently displayed channel illuminates. Clicking the unlit switch changes the display to the other channel.

To edit both channels simultaneously, click on the Link switch.

Using Big Bottom Pro

By putting Big Bottom Pro to use in a Pro Tools session you will find many creative uses for its powerful processing capabilities.

The remaining sections provide instructions on how to get the most out of Big Bottom Pro.

Setting the Gain Structure

If the amount of Big Bottom Pro effect is limited by a lack of headroom in the input material, use the Level control to adjust the signal level to avoid clipping. When using Big Bottom Pro with the Phase switch in the Off position, it is possible to achieve a substantial increase in bass energy without significantly increasing the peak level output.

For optimal performance keep the peak hold meter of the Drive meter inside the yellow area.

Optimizing Big Bottom Pro Effects

When using Big Bottom Pro, the output signal level is equal to the input signal levels plus the bass enhanced Big Bottom Pro effect. The dynamic characteristics of Big Bottom Pro are based on a complex algorithm that includes the signal peak level, the average steady state level as well as the dynamic characteristics. Unlike a bass EQ, which adds a constant boost in the low end, Big Bottom Pro enhancement is added into the input signal dynamically.

Starting with the factory settings, experiment with the controls on Big Bottom Pro to hear how this plug-in effects the low-end frequencies of your source material, as follows:

- If the Drive meter is clipping (in the yellow area), adjust the Drive control for optimal operation.
- Activate the Solo switch to listen to only the Big Bottom Pro side-chain effect.
- Vary the Tune control to hear the low-pass filter isolate the low-end bandwidths of the original input signal.
- De-activate the Solo switch and continue to vary the Tune control until you find the optimal setting.
- Adjust the Mix control to set the amount of Big Bottom Pro effect.
- Use the In/Out switch for an A/B comparison with the output signal and the original input signal.
- Activate the Phase switch and observe the change in the sound characteristics of the Big Bottom Pro effect. For most applications, leave the Phase switch in the Off position.
- Activate the AutoTrace switch and observe the change in the sound characteristics. Also notice that the compression level in the dynamic processor, shown by the Comp meter, is affected as well.
- Readjust the Mix control as desired, to experience the benefits of the Big Bottom Pro plug-in. Remember that a little Big Bottom Pro effect goes a long way.

Chapter 45: Eleven

Eleven is a guitar amplifier plug-in that is available in DSP, Native, and AudioSuite formats. Eleven gives you stunning guitar amplifier, cabinet, and microphone models of the “best of the best” vintage and contemporary gear.

Eleven Free is a free version of Eleven that comes with every Pro Tools system, with a reduced feature set. Eleven Free comes in Native and AudioSuite formats only.



Eleven Plug-in

Eleven Free Plug-In Features

- Two custom amp models from Avid
- Two speaker cabinet models
- Amps and cabinets can be mixed and matched
- Noise Gate to control any unwanted noise
- Settings files (presets) to store and recall factory and custom tones
- Support of any compatible work surface or MIDI controller. MIDI Learn provides effortless mapping to any continuous controller (CC)–capable MIDI device
- Support for sample rates of 44.1 kHz, 48 kHz, 88.2 kHz, and 96 kHz
- Support for mono or multi-mono operation, in up to 8 channel (7.1) format



Eleven can share preset data with the Eleven Rack guitar processor/audio interface from Avid. For more information, see the Eleven Rack User Guide.

Eleven Plug-In Features

- Classic amp models that faithfully recreate the sound and dynamic response of the original amps
- Highly accurate speaker cabinet models with variable speaker breakup (cone distortion)
- Selectable mics, with on- and off-axis options
- Amps, cabs, and mics can be mixed and matched into nearly limitless combinations
- Amps and cabs can be bypassed separately
- All controls can be automated
- Noise Gate to control any unwanted noise
- Settings files (presets) to store and recall factory and custom tones
- Support of any compatible Ethernet or MIDI controller. MIDI Learn provides effortless mapping to any continuous controller (CC)–capable MIDI device
- Support for sample rates of 44.1 kHz, 48 kHz, 88.2 kHz, and 96 kHz
- Support for mono or multi-mono operation, in up to 8 channel (7.1) format

Eleven Input Calibration and QuickStart

This section shows you how to get connected, calibrated, and cranking through Eleven as quickly as possible.

Before You Begin with Eleven

Eleven was designed to model the essential aspects of each amplifier including characteristics of the input stage. Providing an appropriate level of signal delivers the most accurate response from the plug-in.

- If you are working with pre-recorded guitar tracks, see “Using Eleven with Pre-Recorded Tracks” on page 271.
- If you are working with a live guitar signal, follow the steps on the next few pages for optimal input level calibration. Input calibration takes only a couple of minutes, and helps ensure the best results with Eleven, its amps, and its factory presets.

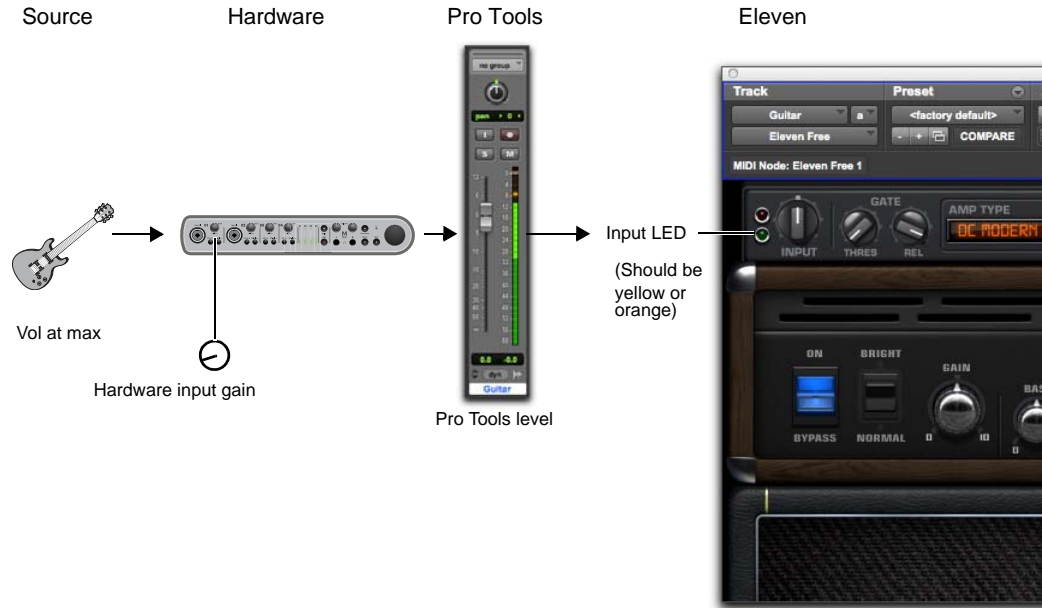

Basic gain stages to calibrate live guitar input for Eleven

Connect your Guitar and Configure Source Input

If your setup includes pedals or other gear, it helps to know whether the final output device is providing an instrument- or line-level signal. Choose and configure your input and source settings accordingly. (Check the *Setup Guide* that came with your system for more information.)

To connect your guitar to a Pro Tools host-based system:

- 1 Do one of the following, depending on your hardware configuration:
 - If you are using an interface that has a DI input (such as a Pro Tools | Mbox Pro), plug your guitar into an available DI input.
 - If you are using your computer's built-in inputs, plug your guitar into an available input.

 *If you use a direct box to convert your guitar's hi-impedance output to a low-impedance signal, connect the direct box to a mic or line input instead of the DI input.*

- 2 Make sure to use the correct input on your interface. For example, on Mbox Pro, plug your guitar into front-panel DI Inputs 1 or 2.



Mbox Pro DI Inputs 1 and 2

 *Mbox Pro back-panel 1/4" inputs are line-level only and should not be used with a guitar.*

To connect your guitar to a Pro Tools HD system:

- 1 Make sure you have a pre-amp (such as an Pro Tools | PRE) or similar unit connected to a Pro Tools HD audio interface (such as a Pro Tools | HD I/O). (Note that Pro Tools | HD OMNI provides built-in pre-amps.)
- 2 Plug your guitar into an available pre-amp input and set its source, impedance, and other settings as needed for your setup.

 *If you use a direct box to convert your guitar's hi-impedance output to a low-impedance signal, set the Line/Inst 1 input to Line source or the equivalent on your particular pre-amp.*

For example, if you are using a PRE, you can plug your guitar directly into the front panel Line/Inst 1 input, then set its source to Inst.

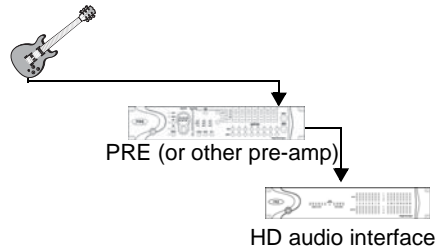

Guitar into Avid PRE into a 192 I/O

Set Hardware and Levels

After plugging in, do the following to set your primary gain and configure your Pro Tools hardware by watching its input indicators (meters). This sets the first stage of your gain structure for Eleven.

To prepare your guitar and Pro Tools host-based hardware for input calibration:

- 1 In Pro Tools, choose Setup > Playback Engine and set your Hardware Buffer to a low enough setting to reduce monitor latency.
- 2 On your guitar, select the highest output pickup or position and set the volume and tone controls to 10 (maximum).
- 3 Strum full chords (your loudest expected playing) while watching the Input indicators on your audio hardware.
- 4 Adjust the Input Gain on your audio interface high enough to indicate a strong signal on the hardware Input LED (but not overloading the input).



Input 1 Gain on Mbox Pro

To prepare your guitar and HD hardware for input calibration:

- 1 On your guitar, select the highest output pickup or position and set all volume and tone controls to the maximum.
- 2 Strum full chords (your loudest expected playing) while watching the Input indicators on your audio hardware.

- 3 Adjust your pre-amp input gain until you see a strong signal on your audio interface Input meters (but not overloading the input).

Set Up a Pro Tools Track

In this step, you'll create and configure an audio track to use for the final stage of input calibration.

To set up and check Track level (all systems):

- 1 Choose Tracks > New, and create one mono Audio track.
- 2 In the Mix window, click the track Input selector and choose your guitar input.
- 3 Click the track Insert selector and select Eleven.

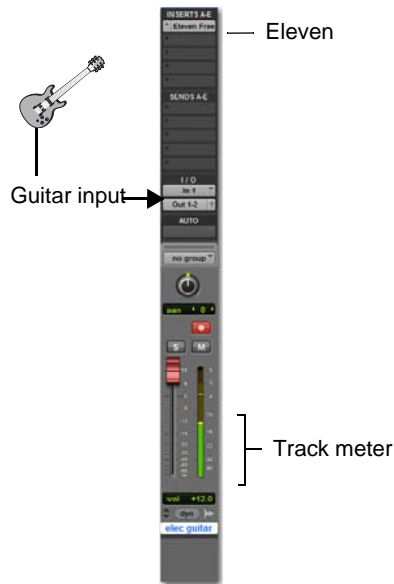

One audio track for input calibration on Pro Tools

- 4 Record enable the audio track, or enable its TrackInput monitoring button (Pro Tools HD software only).

Set Up Eleven

Use Eleven's Input LED to make final gain adjustments and complete the input calibration process.

To calibrate your input signal to the Eleven plug-in:

- 1 Open the Eleven plug-in window by clicking its insert slot. Leave it at its default settings.



Eleven's Input LED (top) and Clip LED (bottom)

- 2 Strum as hard as you can a few more times and watch Eleven's Input LED to see where your level registers. The Input LED lights green, yellow, orange, or red to indicate the following level ranges:

Green (Off to -8) Indicates signal is present, but too low.

Yellow (-8 to -4) Indicates the best level for low output sources, such as single coil pickups.

Orange (-4 to 0) Indicates the best level for higher output sources, such as humbucker pickups.

Red (0 and above) Indicates that you have clipped the plug-in input. Click the Input LED to clear the clip indicator.

- 3 Leaving the Input control on the plug-in at its default setting of 0 (12:00 position), set the signal level going to the plug-in by adjusting the input gain control on your hardware until Eleven's Input LED shows yellow or orange.
- 4 After calibrating, strum as you normally would and/or back down your guitar volume from the maximum setting used for input calibration. Don't worry about the Input LED showing yellow or orange when playing normally. As long as the plug-in isn't indicating clipping, your gain staging should be established.
- 5 Adjust the Output knob in Eleven's Master section to raise or lower the plug-in output signal.

⚠ Proper input calibration of live guitar does not require any adjustment of Eleven's Input control. To learn how this control was designed to work with the amp models, see "Input" on page 275.

Using Eleven with Pre-Recorded Tracks

If the pre-recorded tracks were not calibrated with the Eleven plug-in using the method previously described, you can use the Input control in Eleven to adjust the signal level feeding the input stage of the amp model.

Use your ears as a guide and adjust to taste. Since the Input LED measures the signal level entering the plug-in and precedes the input control, you will not see any changes to the Input LED as you make adjustments.

📖 See "Processing Pre-Recorded Tracks Through Eleven" on page 284 for more information.

Getting Started Playing Music with Eleven

To get started playing music with Eleven:

- 1 Make sure you already calibrated your input signal as explained in the previous sections of this chapter.
- 2 Click the plug-in Librarian menu and choose a factory preset, then play guitar. Take your time to explore — the Presets let you hear all of Eleven’s different amps and combos.



Librarian menu (left) and the Settings menu (right)

- 3 Pick any amp and cabinet from the available types (see “Pairing Amps and Cabinets” on page 279.)
- 4 Refer to “Using Eleven” on page 272 for details on Eleven’s main controls, and for suggested track setups for recording and mixing.

 Use the Settings menu to save, copy, paste, and manage plug-in settings files. To save a setting, see “Eleven Settings (Presets)” on page 274.

Using Eleven

The following sections introduce you to the main sections and controls in Eleven and show you how to use them. You’ll also find suggested track setups and signal routing tips to help you get the most out of Eleven.

Inserting Eleven on Tracks

Eleven can be inserted on Pro Tools audio, Auxiliary Input, Master Fader, or Instrument tracks.

To insert Eleven on a track:

- Click an Insert selector on the track and choose Eleven or Eleven LE.

Channel Formats

Eleven is available as a mono or multi-mono plug-in only. For use in stereo or greater formats choose the multi-mono version.

Sample Rates

Eleven supports 44.1 kHz, 48 kHz, 88.2 kHz and 96 kHz sample rates.

Category and Manufacturer

When Pro Tools plug-ins are organized by Category or Manufacturer, Eleven is listed as follows:

Category Harmonic

Manufacturer Avid

Adjusting Eleven Controls

This section tells you how to adjust controls using your mouse, a Pro Tools controller, or with a MIDI device.

Navigating the Amp, Cab, and Mic Type Selectors

You can click on the name of the current Amp Type, Cab Type, or Mic Type to display their pop-up menus and select an item.

You can also click the Previous/Next arrows to step through Amp, Cabinet, and Mic choices one at a time.



Previous arrow (top) and Next arrow (bottom) (Amp Type shown)

 You can control the Amp, Cab, and Mic Type selectors with MIDI. See “Using MIDI and MIDI Learn with Eleven” on page 273.

Groups and Linked Plug-In Controls

Eleven’s parameters can follow Pro Tools Groups (Mix, Edit, or Mix/Edit) for linked control of multiple inserts. For more information, see the *Pro Tools Reference Guide*.

Using Automation

All of Eleven’s parameters can be automated. When a parameter has been enabled for automation, an LED appears lit near that control.

 See the *Pro Tools Reference Guide* for more information on plug-in automation.

Using a Controller with Eleven

Eleven can be controlled directly from any compatible Pro Tools controller. Eleven appears along with other plug-ins and can be assigned, edited, bypassed and automated using the Insert section as available on the particular controller being used.

About Unused Controls and Controllers

Some amps that have relatively few controls (such as the Tweed Lux) will display controls on a controller that are not actually available with that particular amp model. Even though you can adjust these unused encoders or switches, only those controls seen on-screen for any amp can be adjusted from a controller. Changing an unused control does nothing to the current amp, but does alter the value of that unused control. If you switch to a different amp that does include that (previously unused) control, the new amp inherits the altered setting which can lead to sudden jumps in gain or other settings.

Using MIDI and MIDI Learn with Eleven

Eleven supports MIDI Control Change (CC) messages, meaning that the Master section, amp, cabinet and mic parameters can be controlled remotely by any CC-capable MIDI device. This includes MIDI controllers, mixers, and instruments, as well as the 003® (in MIDI Mode).

MIDI Learn lets you quickly map plug-in controls to a MIDI foot pedal, switch, fader, knob, or other CC-compatible trigger. You can also manually assign controls to specific MIDI CC values.

MIDI control assignments are saved and restored with the Pro Tools session in which they are defined. Settings files (presets) for Eleven do not store or recall MIDI Learn assignments.

To map a MIDI controller to a parameter:

- 1 Make sure your external MIDI device is connected to your system, and recognized by your MIDI Studio Setup (Windows) or Audio MIDI Setup (Mac).
- 2 Create a MIDI track.
- 3 Set the input of the MIDI track to accept input from your external MIDI device.
- 4 Set the output of the MIDI track to Eleven.
- 5 Right-click on any control in Eleven, and do one of the following:
 - Click Learn, then move a control on your MIDI controller. Pro Tools maps whichever control you touch to that plug-in parameter.
 - If you know the MIDI CC value of your foot controller or other device, select it from the Assign menu.
- 6 Right-click on any control in Eleven.



Right-clicking for MIDI Learn



On Mac, you can Control-click an Eleven parameter to show the MIDI Learn menu. Note that you won't be able to use the Control key modifier to “clutch” a Grouped control.

To clear a MIDI assignment:

- Right-click the control and choose Forget.

Eleven Settings (Presets)

You can pick a preset from the plug-in Librarian menu.

To load a preset:

- Click the Librarian menu and select an available Settings file.



Plug-In controls for Eleven Settings files

You can save, import, copy, paste, and manage settings using the Settings menu.

To save your settings as an Eleven preset:

- Click the Settings menu and choose Save Settings. Name the preset, choose a location, and click Save.

You can scroll through and select preconfigured Eleven Settings files (presets) using the plug-in Librarian menu, and the +/- buttons.



For more information on Settings files and folders, see the Pro Tools Reference Guide.

Master Section

The Master section includes plug-in I/O (input/output) and noise gate controls, the Amp Type selector and the Cab Type selector.

The Master section doesn't change when you switch amps. Master section settings are stored and recalled with plug-in presets.



Master section

Input LED

The Input LED shows green, yellow, orange, or red to indicate whether you are under- or over-driving the plug-in. The Input LED is before the Input section of the Master section. To learn more about the Input LED within the Eleven signal chain, see “Eleven Signal Flow Notes” on page 291.

Input

The Input knob provides input trim/boost, for tone and distortion control. The Input range is -18 dB to $+18$ dB.

The Input knob provides a great way to increase or decrease gain with amp models that don't have a separate preamp control. It also provides a way to trim or boost the level of pre-recorded tracks you want to treat with Eleven

The setting of the Input knob is saved and restored with Settings files (presets).

 To learn more about the Input control, see “Eleven Signal Flow Notes” on page 291

Output

The Output control sets the output gain after processing, letting you make up gain or prevent clipping on the channel where the plug-in is being used. Output range is -60 dB to $+18$ dB.

 When you want to adjust Eleven's output level, use the Output knob. For tone/distortion, use the amp Master volume.

Amp Type

Amp Type selects which amplifier model to use (see “Amp Types” on page 276).

Cab Type

This selector lets you select which speaker cabinet model to use (see “Eleven Cabinet Types” on page 279).

Gate

Noise Gate Threshold

The Noise Gate Threshold control sets the level at which the Noise Gate opens or closes. At minimum Threshold setting, the Noise Gate has no effect. At higher Threshold settings, only louder signals will open the Gate and pass sound. Threshold range is from Off (-90 dB) to -20 dB.

Noise Gate Release

The Noise Gate Release control sets the length of time the Noise Gate remains open and passing audio. Adjust the Release to find the best setting for the current task (not too fast to avoid cutting off notes, and not too slow to avoid unwanted noise). Release range is from 10 ms to 3000 ms.

 For suggested gate applications, see “Using the Noise Gate” on page 276. For details on where it derives its key (trigger) and applies its gate, see “Eleven Signal Flow Notes” on page 291.

Using the Noise Gate

You can use the Noise Gate to silence unwanted signal noise or hum, or just for an effect.

To use the Noise Gate to clean up unwanted, low level noise:

- 1 Connect and calibrate your guitar as explained in “Connect your Guitar and Configure Source Input” on page 269.
- 2 For the next steps, hold your guitar but don’t play it (and be sure to leave its volume up). You should hear only the noise that we’ll soon get rid of.
- 3 To make it easier to hear the effect, begin by setting the Release to its middle (12 o’clock) position.
- 4 Now raise the Threshold control to its highest setting, fully clockwise, so that the Gate fully closes (you shouldn’t hear anything coming through Eleven).
- 5 Slowly lower the Threshold control until the Gate opens again to find the cutoff (or, threshold) of the noise.
- 6 Raise the Threshold control again slightly, increasing it only enough to once again silence the noise (hold Command (Mac) or Ctrl (Win) while adjusting to be able to fine-tune the setting in tenths of a dB). Now you’re in the ballpark.
- 7 If you lowered the Release setting as suggested in step 3, make sure to return it to its maximum setting (fully clockwise) before continuing.

Amp Types

The Amp Type selector lets you choose an amp.



Choosing an amp from the Amp Type selector

Available Amp Types in Eleven include the following:

- '59 Tweed Lux *
- '59 Tweed Bass *
- '64 Black Panel Lux Vibrato *
- '64 Black Panel Lux Normal *
- '66 AC Hi Boost *
- '67 Black Panel Duo *
- '69 Plexiglas – 100W *
- '82 Lead 800 – 100W *
- '85 M-2 Lead *
- '89 SL-100 Drive *
- '89 SL-100 Crunch *
- '89 SL-100 Clean *
- '92 Treadplate Modern *
- '92 Treadplate Vintage *
- DC Modern Overdrive
- DC Vintage Crunch

* These models only appear in the full version of Eleven.



Eleven is not affiliated with, or sponsored or endorsed by, the makers of the amplifiers emulated in the product.

Eleven Amp Controls

Each Eleven amp provides a set of controls similar to (and in some cases identical to) those on the actual amp it models. The following sections give a general overview of amp controls.



Amp controls in the default Amp Type

Amp Bypass

The Amp Bypass switch (or lamp) lets you bypass just the amp model, leaving the cab and mic settings in effect. The default setting is On. When set to Bypass, only the amp is bypassed; Master section, cabinet and microphone settings remain active.

Bright

The Bright switch provides extra high frequency response to the input signal, and alters the timbre of the distortion. On some amp models, the effect is most apparent at lower volume settings.

Gain 1

Gain 1 determines the overall gain amount and sensitivity of the amp. When Gain 1 is low it allows for cleaner, brighter sounds with enhanced dynamic response. When set high, the entire personality of

the amp changes, becoming fatter and overdriven. Gain 1 responds differently with each amp model and is designed to have a musical response that closely matches that of its original amp, at all settings. The default setting is 5.0. Gain 1 range is from 0 to 10.

 *All Eleven controls provide identical ranges as the original amps, but some numbers have been adjusted for consistency.*

Gain 2

Gain 2 is a second Gain knob used with some amp models that determines the amount of overdrive in the pre-amp stage. Gain 2 (also known as “Presence” on some amps) allows for more harmonic subtleties in character of the amp tone. The default is 5.0. Gain 2 range is from 0 to 10.

Parallel or Series The Gain 2 control on the Tweed Lux, AC Hi Boost and Plexiglass is in parallel (“jumped”) with the Gain 1 control. The M-2 Lead is in series, meaning the signal goes in and out of Gain 1, then into Gain 2.

Tone

Tone controls let you shape the highs, mids and lows of the amp sound. Electric guitar pickups tend to have a strong low-mid emphasis and little high frequency response, often producing a mid-range heavy sound that requires some treble boost. The response and interaction of the tone controls are unique to each amp.

Bass

The Bass control determines the amount of low end in the amp tone. The response of this control in some models is linked to the setting of the Treble control. The default setting is 5.0. Bass range is from 0 to 10.

Middle

The Middle control determines the mid-range strength in lower gain sounds. With high gain amp models, the Middle control has a more dramatic effect and can noticeably shape the sound of the amp at both the minimum and extreme settings. The default setting is 5.0. The Middle range is from 0 to 10.

Treble

In most amp models, the Treble control is the strongest of the three tone controls. Its setting determines the blend and strength of the Bass and Middle controls. When Treble is set to higher values, it becomes the dominant tone control, minimizing the effect of Bass and Middle controls. When Treble is set to lower values, the Bass and Middle have more effect, making for a darker amp tone. The default setting is 5.0. The Treble range is from 0 to 10.

Presence

The Presence control provides a small amount of boost at frequencies above the treble control. Presence is applied at the end of each amp model pre-amp stage, acting as a global brightness control that is independent of other tone controls. The default setting is 3.0. The Presence range is from 0 to 10.

Master

The Master control sets the output volume of the pre-amp, acting as a gain control for the power amplifier. In a standard master-volume guitar amp, as the Master volume is increased more power tube distortion is produced. The default setting is 5.0. Master range is from 0 to 10.



Some might assume a Master volume knob capable of silencing the amp completely. Not so. Use the Output knob (in the Master section) to silence the output of the plug-in. Use Master volume for tone and distortion.

Tremolo

Tremolo is achieved through the use of amplitude modulation, multiplying the amplitude of the pre-amp output by a waveform of lower frequency. Tremolo is not available on all amps.

Tremolo Speed The Speed control sets the rate of the Tremolo effect. The Tremolo Speed LED pulses at the rate of Tremolo Speed. The default setting is 5.0.



Eleven does not support Tempo Sync.

Tremolo Depth The Depth controls the amount of the Tremolo effect. The default setting for this control is 0.0, which is equivalent to off. Some amp models call the Tremolo Depth control Intensity.

Eleven Cabinet Types

The Cab Type selector lets you pick a cabinet to use with the current amp. The selected cabinet and its controls are displayed directly below the amp controls.

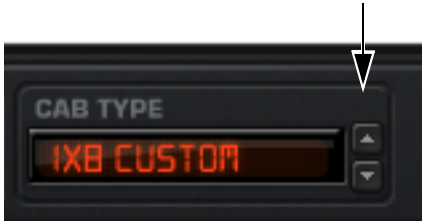

Cabinet Type selector in the Master section

Available cabinets include the following:

- 1x12 Black Panel Lux *
- 1x12 Tweed Lux *
- 2x12 AC Blue *
- 2x12 Black Panel Duo *
- 4x10 Tweed Bass *
- 4x12 Classic 30
- 4x12 Green 25W

** These models only appear in the full version of Eleven.*

Cabinets are listed by their number and diameter of their speakers. For example, “1x12” means a cabinet has a single 12-inch speaker.

 *Eleven is not affiliated with, or sponsored or endorsed by, the makers of the loudspeakers and cabinets that are emulated in the product.*

 *Visit the Avid website (www.avid.com) to learn about each of the cabinets used to create Eleven.*

Pairing Amps and Cabinets

Eleven lets you combine amps and cabinets in traditional pairings (such as the combo amps through their default cabinets) and non-traditional matchups.

Some of the amps modeled in Eleven are “combo” amps. Combo amps have both their amp and speaker housed in the same physical box, meaning there is one and only one cabinet associated with the signature sound of a combo amp. The Tweed Lux and AC Hi Boost are both examples of combo amps.

Other amps are amps-only (heads), and were designed to be run through a speaker cabinet. Many amp/cab pairings have become standards.

Using Settings for Realistic and Classic Pairings

You can use Eleven’s factory Settings files (presets) for combo amps and classic combinations. Settings files store and recall all controls, (including Amp and Cabinet Type).

For combo amps and default combinations:

- Choose a factory Settings file for that amp from Eleven’s Settings menu.

Using the Amp Type and Cabinet Type Selectors for Unlinked Pairing

You can use the Amp Type and Cabinet Type selectors to try your own, unique combinations.

If you want to combine amps and cabs (unlinked):

- Click and choose from the Amp Type and Cabinet Type selectors to create new pairings.

 *Use the Settings menu to save new combinations and build your own custom library (see “Eleven Settings (Presets)” on page 274).*

Eleven Cabinet Controls

All cabinets provide Bypass, Speaker Breakup, Mic Type, and Position controls.



Cabinet controls

Cabinet Bypass

The Bypass switch in the Cabinet section lets you bypass cabinet and microphone processing. When in the Bypass position, no cabinet or microphone processing is applied to the signal. When in the On position, cabinet and microphone settings are applied.

Speaker Breakup

(Full version, HDX Only)

The Speaker Breakup slider lets you specify how much distortion is produced by the current speaker model. Increasing the Speaker Breakup setting adds distortion that is a combination of cone breakup and other types of speaker distortion (emulated by the speaker cabinet model). Range is from 1 to 10.

Below certain frequencies, the speaker cone vibrates as one piece. Above those frequencies (typically between 1 kHz and 4 kHz), the cone vibrates in sections. By the time a wave travels from the apex at the voice coil out to the edge of the speaker cone, a new wave has started at the voice coil. The result is comb filtering and other anomalies that contribute to the texture of the overall sound.

 When enabled, Speaker Breakup draws additional CPU resources.

Mic Type

The Mic Type selector lets you choose the microphone to use with the selected cabinet.



Mic Type selector in the Cabinet section

Available Mic Types include the following:

- Dynamic 7
- Dynamic 57
- Dynamic 409
- Dynamic 421
- Condenser 67
- Condenser 87
- Condenser 414
- Ribbon 121

 Eleven is not affiliated with, or sponsored or endorsed by, the makers of the microphones that are emulated in the product.

Mic Axis

When capturing the sound of a speaker cabinet in a studio, sound engineers select different microphones and arrange them in different placements to get a particular sound. For example, a mic can be pointed straight at a speaker or angled slightly off-center, in order to emphasize (or de-emphasize) certain frequencies that the mic picks up.

On-axis, for most microphones, is a line in the same direction as the long dimension of the microphone and will produce a noticeable difference in coloration when compared to the same microphone in the off-axis position.

In Eleven, the Axis switch lets you toggle between on- and off-axis setting of the currently selected microphone model. The default position for Mic position is On Axis.



Mic Axis switch in the Cabinet section

About Mic Placement

All Eleven cabinets and mics were close mic'd (whether on- or off-axis). This provides the purest tones possible, of any room tone or ambience specific to the Eleven recording environment.

Tracks and Signal Routing for Guitar

The way you set up Pro Tools tracks and signal routing can vary depending on what you want to do while recording and mixing with Eleven. This section gives you a few specific examples of some of the many different ways you can choose to work:

- “Recording Dry: Monitor Through Eleven” on page 281.
- “Recording Wet: Record Eleven-Processed Track to Disk” on page 282.
- “Recording Dry and Eleven Simultaneously” on page 283.
- “Processing Pre-Recorded Tracks Through Eleven” on page 284
- “Blending Eleven Cabinets and Amps” on page 285.

Recording Dry: Monitor Through Eleven

This workflow lets you record dry (clean) while the recorded signal is processed through Eleven, letting you hear it but without committing the track to that tone forever.

The flexibility to audition and compare different settings and combinations of amps, cabinets and microphones is a very creative and powerful tool for mixing and arranging.

To record dry and monitor through Eleven:

- 1 Choose Track > New and configure the New Track to create one mono Audio Track.
- 2 Set the track input to the audio interface input your guitar is plugged in to (such as In 1 (Mono)).
- 3 Insert Eleven on the track (see “Inserting Eleven on Tracks” on page 272).

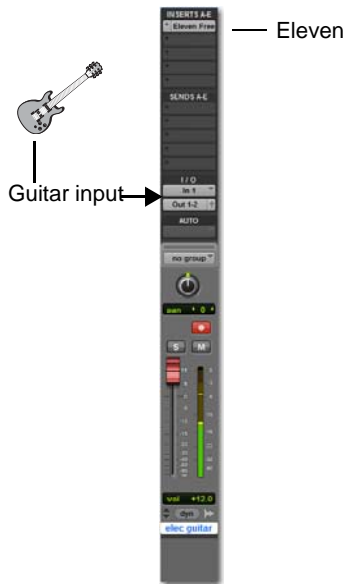

Audio track for recording dry while hearing Eleven

- 4 Choose a Settings file (preset), or adjust Eleven's parameters to get your tone (see "Eleven Settings (Presets)" on page 274).
- 5 Record enable the track, or enable TrackInput monitoring (Pro Tools HD only) and check your levels.
- 6 When you're ready, arm the Pro Tools Transport and press Record to record your part.

The audio that is recorded is the dry (unprocessed) signal only, while playback of the recording is processed through Eleven and any other plug-ins inserted on the track.

Recording Wet: Record Eleven-Processed Track to Disk

In this workflow, the audio output of Eleven is recorded to disk while tracking. Usually, no additional dry track is recorded.

This method commits your track to the original Eleven tone used while tracking. It requires two tracks (an Auxiliary Input and an audio track), but after tracking, the plug-in can be deactivated or removed to up processing resources.

To record guitar with Eleven while playing:

- 1 Choose Track > New.
- 2 Configure a new track by doing the following:
 - Create one mono Auxiliary Input track.
 - Click the Add Row button (+).
 - Create one mono audio track.
 - Click Create.
- 3 In the Mix (or Edit) window, configure the Aux Input by doing the following:
 - Click the Input selector and choose your guitar input (the audio interface input your guitar is plugged in to).
 - Click the Output selector and choose Bus 1.
 - Click the Insert selector and select Eleven.
- 4 Configure the audio track by doing the following:
 - Click the Input selector and choose Bus 1.
 - Record enable the audio track.

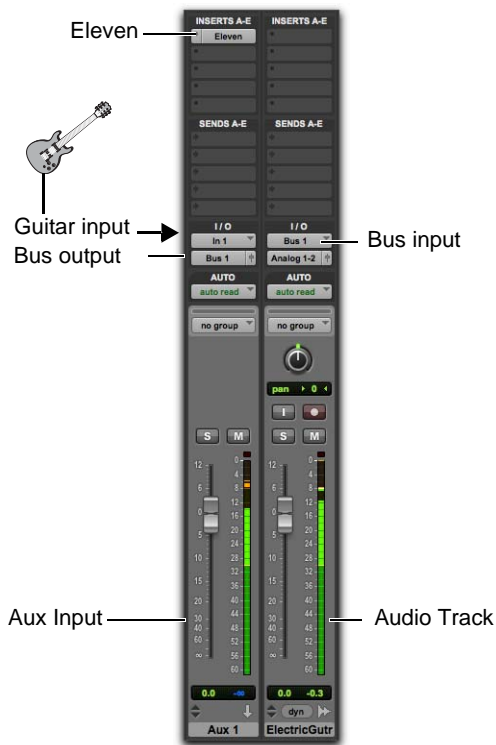

Recording Eleven (printing its output)

- 5 Make sure you are not overloading your input signal by checking levels in all tracks and Eleven's Input LED.
- 6 When you're ready, arm Pro Tools and begin recording.

The output from Eleven is recorded to disk. If you need to conserve DSP or Native processing resources, you can remove or deactivate Eleven after recording.

Recording Dry and Eleven Simultaneously

You can record a dry, unprocessed track and an Eleven-processed track simultaneously.

This method gets the best of both worlds by tracking dry (to experiment with tones later) and at the same time recording the tone used on the original tracking session. It requires two audio tracks, as follows:

To record guitar dry and with Eleven live:

- 1 Choose Track > New.
- 2 Configure the New Tracks dialog to create two mono audio tracks, then click Create.
- 3 In the Mix (or Edit) window, configure the first (left-most) new audio track by doing the following:
 - Click the Input selector and choose your guitar input (the audio interface input your guitar is plugged in to).
 - Click the Output selector and choose Bus 1.
 - Click the Insert selector and select Eleven.
 - Record enable the audio track.
- 4 Configure the second audio track by doing the following:
 - Click the Input selector and choose Bus 1.
 - Record enable the audio track.
- 5 Make sure you are not overloading your input signal by checking levels in all tracks and Eleven's Input LED.
- 6 When you're ready, arm Pro Tools and begin recording.

The dry guitar is recorded to the first audio track, processed through Eleven, then bussed to the second audio track and recorded to disk.

Processing Pre-Recorded Tracks Through Eleven

You can process pre-recorded guitar tracks, or almost any material, through Eleven.

To listen to pre-recorded tracks through Eleven (without re-recording):

- 1 Import and place your audio in a Pro Tools audio track.
- 2 Assign the audio track Output to Bus 1 (or Bus 1-2 if working with stereo material).
- 3 Create an Aux Input track, and configure it by doing the following:
 - Click its track Input selector and choose Bus 1 (or Bus 1-2).
 - Click the Insert selector and select Eleven.
- 4 Begin playback and watch Eleven's Input LED to check your level. Make sure you're not clipping Eleven's input.
- 5 While listening, adjust Eleven's Input knob to increase or decrease input level.
- 6 After setting your gain structure, do any of the following:
 - Try different Settings files (presets) to get your basic amp/cab/mic combination.
 - Adjust amp controls.
 - Try different cabinets and varying amounts of Speaker Breakup.
 - Try different mics and positions to hear how they affect the track.
- 7 Apply other plug-ins, or bus the Aux Input to another track for additional processing.

To process and re-record tracks through Eleven:

- 1 Import and place your audio in a Pro Tools audio track.
- 2 Configure the source audio track by doing the following:
 - Assign the audio track Output a bus (such as Bus 1 if mono, or Bus 1-2 if stereo).
 - Click the Insert selector and select Eleven.
- 3 Choose Track > New and create one mono audio track.
- 4 Configure the new audio track by doing the following:
 - Click its track Input selector and choose the Bus 1 (or Bus 1-2).
 - Click the Insert selector and select Eleven.
- 5 Record enable the new audio track (or enable TrackInput monitoring if using Pro Tools HD).
- 6 Begin playback and start listening.
- 7 While listening, adjust Eleven's Input knob to increase or decrease input level.
- 8 When everything sounds and looks good, locate to where you want to begin recording (or make a time selection), arm the Pro Tools Transport and press Play to start recording.

Blending Eleven Cabinets and Amps

You can use Eleven for multi-cabinet and multi-amp setups so you can blend their signals together. This classic technique lets you get tones that no single combo, cabinet, or amp could produce. Unlike working with real amps, this is simple to achieve with Pro Tools track, signal routing, and plug-in features.

Blending Eleven Cabinets

In this example you'll see how to take the output of one Eleven amp and send it to multiple cabinets so you can blend different cabinets, multi-mic one cabinet, or both.

To blend multiple cabinets:

- 1 Choose Tracks > New.
- 2 Configure a new track by doing the following:
 - Create one mono Audio Track.
 - Click the Add Row button.
 - Create three mono Aux Inputs.
 - Click Create.
- 3 In the Mix or Edit window, configure the audio track by doing the following:
 - Click the audio track Input selector and choose your guitar input (the audio interface input your guitar is plugged in to).
 - Click the Output selector and choose Bus 1.
 - Click the Insert selector and select Eleven.

- 4 Select all three Aux Input tracks by Shift-clicking their Track Name displays (make sure your audio track isn't still selected). This lets you work with the three Aux tracks "as one" in the next few steps.



Three tracks, selected

- 5 Hold Option+Shift (Mac) or Alt+Shift (Windows) while doing each of the following:
 - Choose Bus 1 from the Input selector of any of the three selected Aux Inputs.
 - Click the Insert selector of any of the three and select Eleven.
 - Click the next available Insert selector on any of three selected Aux Inputs and select the TimeAdjuster (short) plug-in.
- 6 Open the Eleven plug-in on the audio track and click the Cabinet Bypass to bypass Cabinet and microphone processing.
- 7 Open one of the Eleven plug-ins on any of the three selected Aux Input tracks and Opt+Shift+click (Mac) or Alt+Shift+click (Windows) the Amp Bypass switch.
- 8 Solo the first Aux Input track.

Amp on,
Cab bypassed

Amps bypassed/Cabs on



Setup for blending cabinets

- 9 Click to open the Eleven plug-in window on the first Aux Input, and do any of the following:
 - Choose a cabinet.
 - Choose a mic and its position.
 - Adjust Speaker Breakup.
- 10 When you're done, close the plug-in window and then unsolo the track.
- 11 Solo the next Aux Input track, and repeat to configure its cabinet and mic settings.
- 12 Repeat for other Aux Input tracks to configure their cabinet and mic settings.

13 When you have set your cabinet tones, make sure to unsolo all the Aux Inputs and begin playing so you can hear the combined tone of all three cabinet channels.

14 Do the following to continue:

- Balance the tracks using the volume faders on the Aux Input tracks.
- Try different pan positions for each Aux Input track.
- Evaluate the phase relationships of the combined signals and adjust accordingly (see “Phase Considerations with Blending in Eleven” on page 288).

If You Plan on Blending Cabinets

The Eleven plug-in emulates the variation in cabinet response that is unique to each amp/cab combination. In the physical world, these variations are the result of the distinct loads put out by each amp, and the way the cabinet handles (responds to) that particular type of signal. Though subtle, the effect of this is a unique cabinet resonance.

In each Eleven plug-in you insert on a track, the currently selected Amp Type has a similar effect on the sound of its current cabinet, even when the amp section itself is bypassed.

This does not mean that the (bypassed) amp *settings* affect the cabinet tone, only the chosen amp type. This could bring just the right amount of extra low, low-mid, or mid-range response to the cabinet.



Different amps can also have a different number of stages, which can affect polarity. See “Phase Considerations with Blending in Eleven” on page 288 for more information.

How Do I Use This?

Here are a few suggested ways you can pair Eleven's amps and cabinets:

- ◆ To accurately capture the sound of one amp split to and driving multiple cabinets, make sure the same Amp Type is selected in all the Eleven plug-ins (all the cabinets as well as the active amp).
- ◆ For maximum variety, mix and match bypassed amps with active cabinets.
- ◆ For realism with the combo amps (such as the Tweed Lux and AC Hi Boost), make sure to use their default cabinets.

Blending Eleven Amps

You can easily set up tracks and Eleven for multi-amp setups.

To blend multiple amps:

- 1 Set up tracks and signal routing as explained in the previous workflow (see “To blend multiple cabinets:” on page 285).
- 2 Remove (or simply bypass) the Eleven plug-in on the source input/track.



To maximize processing resources, remove the Eleven plug-in on the source track, or make the plug-in Inactive. See the Pro Tools Reference Guide for more information.



Setup for blending amps

- 3 Solo the first Aux Input track.
- 4 Click to open the Eleven plug-in window on the soloed Aux Input, and do any of the following:
 - Make sure the amp and cabinet are active (not bypassed).
 - Choose a preset (Settings file).
 - Pair any amp with any cabinet.
 - Choose a mic and its position.
 - Adjust Speaker Breakup.
- 5 Solo the next Aux Input track, and repeat to configure its settings for a different tone.

- 6 Repeat for other Aux Input tracks to configure their settings.
- 7 When you have set your tones, make sure to un-solo all the Aux Inputs.
- 8 Continue playing so you can hear the combined tone of all the amps.
- 9 Do the following to continue:
 - Balance the tracks using the volume faders on the Aux Input tracks.
 - Try different pan positions for each Auxiliary Input track.
- 10 Evaluate the phase relationships of the combined signals and adjust accordingly (see “Phase Considerations with Blending in Eleven” on page 288).

Phase Considerations with Blending in Eleven

When multi-tracking guitar, experienced engineers know how to identify and take advantage of the phase relationships that exist between different signals. Adjusting phase is not just a corrective technique either, it’s also a powerful creative technique for tone, as well as for special effects.

You can use the TimeAdjuster plug-in to flip phase and to adjust timing in single-sample increments, as described in the next sections.

Flipping Phase (Polarity)

Electric guitar is often recorded to more than one track, such as one dry or DI track, plus one or more tracks of a mic’d amp. The different signal paths of direct tracks versus mic tracks affect the timing relationships of the audio. Depending on the signal chain of each track, the signals can get so out of alignment that they nearly cancel each other out.

Sending a single source track through multiple, unique amps can pose an additional challenge in that each tube stage in an amp usually inverts the signal. So, depending on whether the number of tube stages in an amp is odd or even, that amp will either be inverting or non-inverting, respectively. If you send an identical signal to two amps and one is inverting while the other is non-inverting, signal cancellation will result. All amps in Eleven accurately model the number of amp stages found in all the original hardware.

If you want to keep it simple and be able to experiment with phase flip, do the following.

To use the TimeAdjuster plug-in to flip phase when blending amps or cabinets:

- 1 Configure your audio track and Aux Inputs as instructed in “Blending Eleven Cabinets and Amps” on page 285. Make sure each Aux Input has an Eleven plug-in followed by a TimeAdjuster plug-in.
- 2 Open the plug-in window for each of the TimeAdjuster plug-ins (click the first one to open it, then Shift-click each of the other TimeAdjuster plug-ins).
- 3 Click the Phase switch in the first TimeAdjuster plug-in to invert the polarity. Listen to the effect it has on the combined signal. Click it again to disengage (flip back).
- 4 Click the Phase switch on the next channel’s TimeAdjuster plug-in, listen, then disengage.
- 5 Repeat for additional Eleven/TimeAdjuster channels.
- 6 Try combinations of flipped and non-flipped Phase settings to find the ideal relationship for the currently blended amps and cabinets.

Tweaking Phase

If each of the mics used on a single cabinet are not positioned carefully, comb filtering and other frequency anomalies can occur. With real amps, the engineer moves one or more mics to find their optimal positions relative to the source, and to each other.

To hear the effect of small adjustments to the phase relationships of signals, do the following.

To use the Time Adjuster plug-in to control phase:

- 1 Configure your audio track and Aux Inputs as instructed in “Blending Eleven Cabinets and Amps” on page 285. Make sure each Aux Input has an Eleven plug-in followed by a TimeAdjuster (short) plug-in.
- 2 Open the plug-in window for each of the TimeAdjuster plug-ins (click the first one to open it, then Shift-click each of the other TimeAdjuster plug-ins).
- 3 Adjust the Delay slider in one sample increments. Listen to the effect it has on the combined signal. Repeat, increasing the Delay by one sample each time.
- 4 Try combinations of TimeAdjuster settings with flipped and non-flipped Phase settings for endlessly variable tonal possibilities.

Eleven Tips and Suggestions

This section leaves you with some tips and suggestions for other ways you can integrate Eleven into your sessions.

Changing Settings Versus Switching Amps

Many guitarists use different tones to maximize the contrast between sections of a song (intro, verse, chorus, or bridge). Some examples include:

- Soft (or clean) tone for the verse, kick in the distortion for the chorus.
- Using tremolo during the intro and the bridge.
- Doubling the rhythm track halfway through the verse to build momentum.

Pro Tools automaton is the key to these and other techniques:

- ◆ For simple, single amp contrasts such as soft/loud, choose an amp and automate its gain, drive, volume or other parameter to achieve the desired tone change. This uses the least amount of processing resources of the examples provided here.
- ◆ To switch amps, automate the Amp Type selector and any other controls (you cannot automate the selection of Pro Tools plug-in Settings files). Depending on the amount of overlap or crossfading you want between tones, you might be better off using the next, multi-Eleven workflow.



See the Pro Tools Reference Guide to learn about Snapshot automation, Glide, and other automation features.

◆ For maximum flexibility, control and variety, use a dry track bussed to multiple Aux Inputs, each with a different Eleven tone (see “Blending Eleven Amps” on page 287 for instructions). Configure one for tone A, configure the next Eleven (on the next Aux Input) for tone B (which could be a completely different amp and sound) and so on. Then use Pro Tools track Volume (fader) automation to fade the different Eleven tracks in and out at the right times. This gives the greatest amount of control over the transition between amps and tones, while also letting you stack and layer amps.

Managing Eleven Plug-In Resources

If system resources need to be conserved or minimized, you can “bus record” with effects to commit Eleven tones to disk. See “Recording Wet: Record Eleven-Processed Track to Disk” on page 282.

Or, use the AudioSuite version to print Eleven tracks to disk. AudioSuite is especially useful when you’re processing loops or other shorter-form guitar material.

Beyond Eleven: Some Suggested Effects

If you’re new to guitar or new to Pro Tools, you might want to know about a few simple effects you can add to your Eleven guitar tracks using nothing more than a few of the plug-ins included with Pro Tools.

Bussing and Submixing

Not so much a plug-in or effect as a standard operating procedure, multiple guitar tracks are often submixed to stereo Aux Input for centralized level control of those tracks. This is especially useful for applying compression or limiting, creating stem mixes, and many other practical uses. See your

Pro Tools Reference Guide for mixing and submixing setups and suggestions, and try them out while exploring some of the following effects suggestions.

Dynamics

Compression, limiting, expansion and gating are all useful effects for guitar. Different results can be achieved using each of the different types of dynamics processing, in combination with signal routing for individual (discrete) versus submix (shared resource) processing. Here are a few examples:

- ◆ If all you seek is the taming of occasional dynamic aberrations within a track (meaning, you just need to clamp a couple “overs”), try putting a limiter on the individual track (after Eleven).
- ◆ To “glue” multiple rhythm tracks or tones together, bus them to a stereo Aux Input and apply heavy compression or limiting to that Aux Input. Experiment with different dynamics plug-ins such as Dyn 3 or any of Avid’s classic compressor processors to find one that works best for the material. Don’t be afraid to use extreme compression ratios to achieve this effect.

EQ

Simple EQ processing can be used to soften “hot spots” in the playing range of some guitars. Using any of the included EQ plug-ins, you can also try applying drastic shelving or band-limiting as a special effect, or automate a filter sweep to simulate a wah-style effect.

Echo and Delay

To add echo to the guitar track, bus an Eleven track to an Aux Input and put a Delay plug-in on the Aux. Try other delay plug-ins to unlock the secrets of multi-tap, ping-pong, and other specialized applications.

Eleven Signal Flow Notes

The following figure shows the signal flow through Eleven from its input source to its output destination.

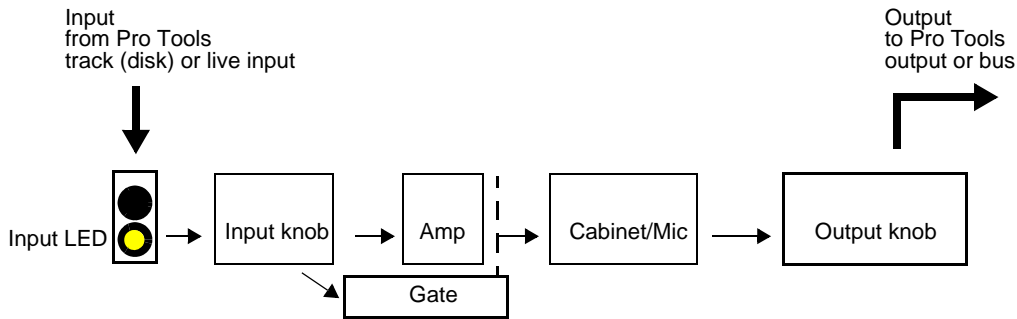

Signal flow through Eleven

Plug-Ins are Pre-Fader

Keep in mind that inserts (plug-ins) in Pro Tools are post-disk/live input but pre-fader. The track fader does not affect the signal into any plug-ins inserted on that same track. This is the same for all Pro Tools inserts, not just Eleven.

Input LED before the Input Knob

The Input LED is before the Input section of the Master section, which is prior to the first input stage of each amp. This lets you determine whether you're clipping a signal before it enters the Eleven signal chain. The Input LEDs will light red when the signal has clipped the input. (If this occurs, insert the Trim plug-in before Eleven and use its (Trim) gain control to attenuate the signal.)

Input Knob and Amp Gain

Eleven actually gives you two separate input gain stages to the plug in:

- ◆ The Input knob in the Master section, which affects the signal level *before entering* the amplifier model.
- ◆ The gain knob(s) on each amplifier, which control the *main input stage* of that particular amplifier model.

This makes the Input knob useful for increasing or decreasing gain on amps that don't have a separate preamp.

Noise Gate After the Input Knob

The Noise Gate is keyed (triggered) from the input signal. The gate is applied to the output of the amp; when open, it lets sound pass from the amp to the cabinet module, and when closed, it silences amp output to the speaker cabinet.

Chapter 46: Lo-Fi

Lo-Fi provides “retro,” down-processing effects.

Lo-Fi features include:

- Bit-rate reduction
- Sample rate reduction
- Soft clipping distortion and saturation
- Anti-aliasing filter
- Variable amplitude noise generator

Lo-Fi is available in DSP, Native, and AudioSuite formats.

Lo-Fi supports 44.1 kHz, 48 kHz, 88.2 kHz, 96 kHz, 176.4 kHz and 192 kHz sample rates.

Lo-Fi operates as a mono, multi-mono, or stereo plug-in.



Lo-Fi

Lo-Fi down-processes audio by reducing its sample rate and bit resolution. It is ideal for emulating the grungy quality of 8-bit samplers.

Lo-Fi Controls

Sample Rate

The Sample Rate slider adjusts an audio file’s playback sample rate in fixed intervals from 700 Hz to 33 kHz in sessions with sample rates of 44.1 kHz, 88.2 kHz, or 176.4 kHz; and from 731 Hz to 36 kHz in sessions with sample rates of 48 kHz, 96 kHz, or 192 kHz. Reducing the sample rate of an audio file has the effect of degrading its audio quality. The lower the sample rate, the grungier the audio quality.

The maximum value of the Sample Rate control is Off (which effectively means bypass).

! *The range of the Sample Rate control is slightly different at different session sample rates because Lo-Fi’s subsampling is calculated by integer ratios of the session sample rate.*

Anti-Alias Filter

The Anti-Alias control works in conjunction with the Sample Rate control. As you reduce the sample rate, aliasing artifacts are produced in the audio. These produce a characteristically dirty sound. Lo-Fi's anti-alias filter has a default setting of 100%, automatically removing all aliasing artifacts as the sample rate is lowered.

This control is adjustable from 0% to 100%, letting you add precisely the amount of aliasing you want back into the mix. This slider only has an effect if you have reduced the sample rate with the Sample Rate control.

Sample Size

The Sample Size slider controls the bit resolution of the audio. Like sample rate, bit resolution affects audio quality and clarity. The lower the bit resolution, the grungier the quality. The range of this control is from 24 bits to 2 bits.

Quantization

Lo-Fi applies quantization to impose the selected bit size on the target audio signal. The type of quantization performed can also affect the character of an audio signal. Lo-Fi provides you with a choice of Linear or Adaptive quantization.

Linear Linear quantization abruptly cuts off sample data bits in an effort to fit the audio into the selected bit resolution. This imparts a characteristically raunchy sound to the audio that becomes more pronounced as the sample size is reduced. At extreme low bit-resolution settings, linear quantization will actually cause abrupt cut-offs in the signal itself, similar to gating. Thus, linear resolution can be used creatively to add random percussive, rhythmic effects to the audio signal when it falls to lower levels, and a grungy quality as the audio reaches mid-levels.

Adaptive Adaptive quantization reduces bit depth by adapting to changes in level by tracking and shifting the amplitude range of the signal. This shifting causes the signal to fit into the lower bit range. The result is a higher apparent bit resolution with a raunchiness that differs from the harsher quantization scheme used in linear resolution.

Noise Generator

The Noise slider mixes a percentage of pseudo-white noise into the audio signal. Noise is useful for adding grit into a signal, especially when you are processing percussive sounds. This noise is shaped by the envelope of the input signal. The range of this control is from 0 to 100%. When noise is set to 100%, the original signal and the noise are equal in level.

Distortion/Saturation

The Distortion and Saturation sliders provide signal clipping control.

The Distortion slider determines the amount of gain applied and lets clipping occur in a smooth, rounded manner.

The Saturation slider determines the amount of saturation added to the signal. This simulates the effect of tube saturation with a roll-off of high frequencies.

Output Meter

The Output Meter indicates the output level of the processed signal. Note that this meter indicates the output level of the signal—not the input level. If this meter clips, the signal may have clipped on input before it reached Lo-Fi. Monitor your send or insert signal levels closely to prevent this from happening.

Chapter 47: Pro Subharmonic

Avid Pro Subharmonic is an AAX plug-in (DSP, Native, and AudioSuite) that synthesizes low-frequencies based on the harmonic content of the source audio signal.

Pro Subharmonic supports 44.1 kHz, 48 kHz, 88.2 kHz, 96 kHz, 176.4 kHz, and 192 kHz sample rates.

The multichannel version of Pro Subharmonic supports stereo audio, and can also add a channel of LFE (.1) content to any 5.0, 6.0, or 7.0 track. Subharmonic material may also be added to the existing LFE channel of a 5.1, 6.1, or 7.1 track.

The mono/multi-mono version should be used for all other channel formats.

- ⚠ *Greater-than-stereo formats are only available with Pro Tools | HD Software.*
- ⚠ *7.0 SDDS to 7.1 SDDS and 7.1 SDDS to 7.1 SDDS instances of Pro Subharmonic are Native-only. All other channel formats are supported on both Native and DSP.*



Pro Subharmonic plug-in

In addition to standard knob, button, and fader controls, Pro Subharmonic also provides a graphic display of the synthesized frequencies and of the dynamic curves of the low pass and high pass filters applied to the low frequencies.

Metering

Pro Subharmonic provides channel-maximum sample peak meters for Input and Output signals.

The Peak Hold indicator appears as a thin line in the meter. This provides highly accurate visual metering correlation with the audio signal.

Input and Output meters use the following color coding:

Dark Blue Indicates nominal levels from -90 dB to -20 dB.

Light Blue Indicates pre-clipping levels, from -20 dB to 0 dB.

Yellow Indicates full scale levels from 0 dB to $+6$ dB.



Peak Hold indicator

Average meter

Pro Subharmonic Input meter

Input

The Input section provides input metering and controls for adjusting the level of the input signal.

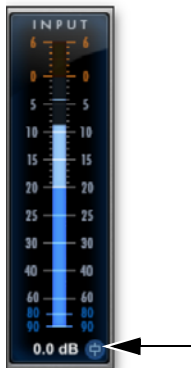

Input Level control

Input Level

The Input Level control sets the input gain of the plug-in before processing, letting you boost or attenuate gain at the plug-in input stage.

To adjust the level of the input signal, do one of the following:

- Click in the Input Level field and type a value (-18.0 dB to $+18.0$ dB).
- Click the Input Level control and drag up or down to adjust the Input Level setting.

Input Meters

The Input meters show channel-maximum sample peak meters summed from all input channels before processing (from -90 dB to $+6.0$ dB).

Output

The Output section provides output metering and controls for adjusting the level of the output signal.

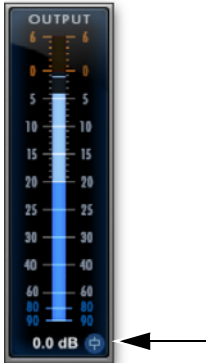

Output Level control

Output Level

The Output Level control sets the output level after processing, letting you boost or attenuate gain of the output signal.

To adjust the output level, do one of the following:

- Click in the Output Level field and type a value (–18.0 dB to +18.0 dB).
- Click the Output Volume control and drag up or down to adjust the Output Volume setting.

Output Meters

The Output meters show channel-maximum sample peak meters summed for all output channels after processing (from –90 dB to +6.0 dB).

Dynamic Frequency Display

Pro Subharmonic provides a graphic display for the synthesized frequency content, low frequency content already present in the source audio, and for the low and high pass filters.



Graphic Frequency and Dynamics display

High Pass Filter Curve Displays the frequency range and dynamic curve for the High Pass filter.

Low Pass Filter Curve Displays the frequency range and dynamic curve for the Low Pass filter.

Lower Synthesized Band Displays the dynamics of the lower range of synthesized frequencies.

Upper Synthesized Band Displays the dynamics of the upper range of synthesized frequencies.

Direct Bass Band Displays the dynamics and the frequency range of the direct bass band (the bass frequency content from the source audio signal).

High Pass and Low Pass Filter Controls

The High Pass and Low Pass filters shape the output of Pro Subharmonic. These filters apply to the direct, unprocessed low frequency content of the source signal as well as the synthesized frequencies.

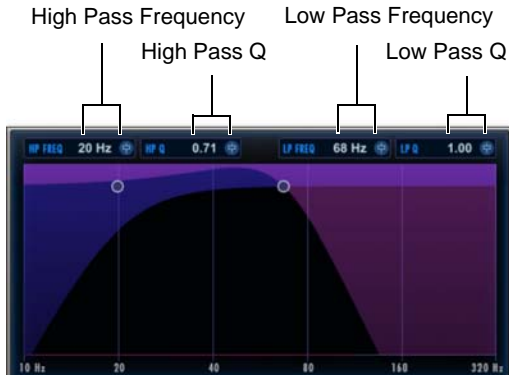

High Pass and Low Pass Filter controls

HP Freq Sets the high frequency for the High Pass filter (5–1000 Hz).

HP Q Sets the Q for the High Pass filter (0.10–5.00).

LP Freq Sets the low frequency for the Low Pass filter (5–1000 Hz).

LP Q Sets the Q for the Low Pass filter (0.10–5.00).

To adjust the Frequency of the High Pass or Low Pass filter, do one of the following:

- Drag the fader icon, or drag in the numeric entry field.
- Click the numeric entry field, type a value, and press Enter.
- Move the cursor over the frequency curve in the Frequency Graph so that it shows the “FREQ” cursor, then drag to adjust the Frequency value.



Adjusting the Frequency setting on the Frequency Graph

To adjust the Q of the High Pass or Low Pass filter, do one of the following:

- Drag the fader icon, or drag in the numeric entry field.
- Click the numeric entry field, type a value, and press Enter.
- Move the cursor over the frequency curve in the Frequency Graph so that it shows the “Q” cursor, then drag to adjust the Q value.

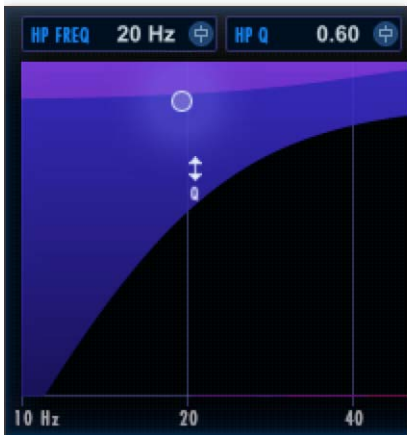

Adjusting the Q setting on the Frequency Graph

Subharmonic Frequency Range

Use the Subharmonic Frequency Range buttons to specify the frequency range of the source signal for the synthesized audio content. For example, in a post production setting, you might use the lowest option to reinforce an explosion in the LFE channel of a 5.0 source signal. Or, you might use the 60–90 Hz option for a stereo music mix to give it a little more “bump.” The lower settings can add power to kick drums and explosions, while the higher ones add fatness to bass lines and low mid-range audio source signals. The best setting will depend on the audio content.

 You can also use MIDI to tune Pro Subharmonic. This can be especially useful for music production. See “Tuning Subharmonics with MIDI” on page 303.

To set the frequency range for synthesized subharmonics, click one of the following options:

- 120–180 Hz
- 80–120 Hz
- 60–90 Hz
- 40–60 Hz



Frequency Range Selector buttons

 Shift-click the Input (Hz) button to automatically adjust the High Pass and Low Pass Frequency settings to align with the Input (Hz) setting.

Lower, Upper, and Direct Gain Controls

Pro Subharmonic provides gain controls for the lower band, upper band, and direct bass band. You can also solo each.



Band Gain controls

The Lower Band Gain control corresponds to the lower frequency of the currently selected Subharmonic Frequency Range setting. Likewise, the Upper Band Gain control corresponds to the upper frequency of the currently selected Subharmonic Frequency Range setting. The Direct Gain control lets you blend in some of the low frequency content of the source signal.

To adjust the gain for the Lower Band, Upper Band, or Direct Bass Band, do one of the following:

- Drag the Gain knob up or down, or to the left or right.
- Click the Gain field and type a value between -120 dB and 24 dB.
- Move the cursor over the corresponding Gain curve in the Frequency Graph so that it shows the “Gain” cursor, and drag to adjust the Gain value.



Adjusting the Gain setting on the Frequency Graph

To solo the Lower Band, Upper Band, or Direct Bass Band:

- Click the corresponding Solo button.

Drive

Use the Drive control to adjust the level of all three bands. The Drive control applies soft-saturation distortion, so it can be used to prevent internal clipping. The Drive effect is shaped by both the Low Pass and High Pass filters.

You can also select any one of six Drive Character options. These settings change the behavior and sound of Pro Subharmonic by altering the resonances of the internal filters and by adjusting the contour of the saturation stages in the processed signal path. For the cleanest, most direct sound, use Clean I. For a sound that adds some color, select one of the Resonant or Distort options.

Experiment with the various Drive Character options and the Drive level setting until you find the tone-quality you want.



Drive control

To adjust the amount of Drive, do one of the following:

- Drag the Drive knob up or down, or to the left or right.
- Click the Gain field and type a value between -18.0 dB and 18.0 dB.

To set the Drive Character, select one of the following options:

- Clean I
- Clean II
- Resonant I
- Resonant II
- Distort I
- Distort II

Mix Controls

Mono and Stereo tracks provide a single Mix control to balance the wet (added bass) signal and the dry signal. If any of the bands are soloed, the Mix solo button (the button to the right of the numeric field) flashes. Click the flashing button to unsolo all soloed bands. You can click the unlit Mix solo button to effectively mute the dry signal regardless of the Mix setting. This lets you audition only the synthesized and processed signal.



Mix control (Mono and Stereo tracks)

To adjust the dry/wet mix, do one of the following:

- Drag the Mix knob up or down, or to the left or right.
- Click the Gain field and type a value between 0% (all dry) and 100% (all wet).

 *When Mix is at 50%, both the wet and dry signal paths are at full volume. Setting the Mix control to values below 50% keeps the dry level at full, but decreases the amount of the wet signal. Conversely, settings the Mix control to values over 50% keeps the wet level at full, but decreases the level of the dry signal.*

For surround tracks, Pro Subharmonic provides multiple Mix controls.

Mix Output Lets you mix the output of Pro Subharmonic between the LFE channel and the Left and Right channels.

Wet Lets you mix the wet signal from 0–100% to the plug-in output.

Dry Lets you mix the dry signal from 0–100% to the plug-in output.

Wet and Dry Solo Buttons Let you solo the wet or dry output signals respectively. Only one of these may be soloed at a time (for example, soloing the Dry signal while the Wet signal is already soloed cancels the solo on the Wet signal).



Mix control (surround tracks)

Surround Send Controls

When Pro Subharmonic is inserted on a surround track, it provides controls to mix how much of the source audio is sent from the Front channels, the Center channel, the Surround channels, and the LFE channel (if present) for Subharmonic synthesis processing. For example, if your source audio has a big sound effect in the center channel and music in the front left and right channels, and you want subharmonics synthesized only from the sound effect, turn up the Center channel input and turn down the Front and Surround channel inputs. On .1 tracks only, Pro Subharmonic provides an LFE control so that you can create subharmonics using the audio on the LFE channel. Each input source can be soloed.



Surround Send controls

Front Send Lets you feed Pro Subharmonic from the front left and right input channels.

Center Send Lets you feed Pro Subharmonic from the center input channel.

Surround Send Lets you feed Pro Subharmonic from the surround input channels.

LFE Send (.1 Format Tracks Only) Lets you feed Pro Subharmonic from the LFE input channel.

Tuning Subharmonics with MIDI

In addition to using the Range Setting buttons, you can use MIDI to tune Pro Subharmonic. Pro Subharmonic can receive MIDI note numbers 12 through 60. This means that you can use MIDI notes to set the Band frequencies from 16 Hz up to 262 Hz. Use this to reinforce the low end of your program material based what key or mode it is in.

When Pro Subharmonic is receiving MIDI, the MIDI In icon highlights, the Range settings are controlled by the MIDI input, and the Range Setting buttons are bypassed. The Lower band is tuned to the incoming MIDI note and the Upper band is tuned to a perfect fifth above that.

⚠ *VENUE and Media Composer do not support MIDI.*

To route MIDI to Pro Subharmonic:

- 1 Insert Pro Subharmonic on a track.
- 2 Create a new MIDI track.
- 3 Route the output of the MIDI track to the corresponding Pro Subharmonic MIDI node.



Routing MIDI to Pro Subharmonic

To tune Pro Subharmonic with MIDI:

- 1 Use a MIDI track routed to the specific instance of Pro Subharmonic that you want to control.
- 2 Record, enter, or import a MIDI sequence on the MIDI track.

⚠ *Be sure to only use a monophonic MIDI sequence or live performance to control Pro Subharmonic.*

- 3 Play back the session. The MIDI In icon highlights when Pro Subharmonic is receiving MIDI.



Routing MIDI to Pro Subharmonic

 The MIDI tuning feature can be used to lock Pro Subharmonic to a bass Virtual Instrument. Routing a MIDI track to both the input node of a bass Virtual Instrument and the input node of a Pro Subharmonic that is inserted after the Virtual Instrument creates subharmonics evenly across a four-octave playing range (from MIDI note number 12 up to MIDI note number 60).

 When using Pro Subharmonic with a bass Virtual Instrument, you may want to transpose the bass part up or down to better tune Pro Subharmonic. To do this, copy and paste the MIDI sequence to a new MIDI track and route the track output to Pro Subharmonic. Use Real-Time MIDI properties on the MIDI track to transpose the sequence as desired.

MIDI Input to Pro Subharmonic AudioSuite

The AudioSuite version of Pro Subharmonic also supports MIDI input. This can be used to fine-tune the input frequency range for the AudioSuite version of Pro Subharmonic.

To tune Pro Subharmonic AudioSuite with MIDI:

- 1 Select the audio you want to process in the Edit window.
- 2 Open the AudioSuite version of Pro Subharmonic.
- 3 Create a new MIDI track and rout its output to Pro Subharmonic.
- 4 Send a MIDI note to Pro Subharmonic via the MIDI track.
- 5 Process the selected audio with Pro Subharmonic AudioSuite.

Chapter 48: Recti-Fi

Recti-Fi provides additive harmonic processing effects through waveform rectification. Recti-Fi features the following effects:

- Subharmonic synthesizer
- Full wave rectifier
- Pre-filter for adjusting effect frequency
- Post-filter for smoothing generated waveforms

Recti-Fi is available in DSP, Native, and Audio-Suite formats.

Recti-Fi supports 44.1 kHz, 48 kHz, 88.2 kHz, 96 kHz, 176.4 kHz and 192 kHz sample rates.

Recti-Fi operates as a mono, multi-mono, or stereo plug-in.



Recti-Fi

Recti-Fi provides additive synthesis effects through waveform rectification. Recti-Fi multiplies the harmonic content of an audio track and adds subharmonic or superharmonic tones,

Recti-Fi Controls

Recti-Fi Pre-Filter Control

The Pre-Filter control filters out high frequencies in an audio signal prior to rectification. This is desirable because the rectification process can cause instability in waveform output—particularly in the case of high-frequency audio signals. Filtering out these higher frequencies prior to rectification can improve waveform stability and the quality of the rectification effect. If you wish to create classic subharmonic synthesis effects, set the Pre-Filter and Post-Filter controls to a relatively low frequency, such as 250 Hz.

The range of the Pre-Filter is from 43 Hz to 22 kHz, with a maximum value of Thru (which effectively means bypass).

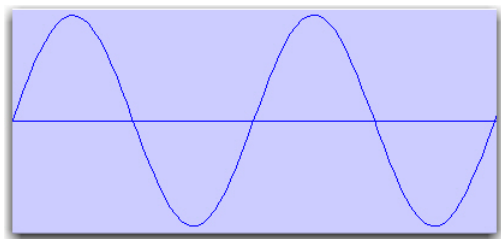

Normal waveform

Recti-Fi Rectification Controls

Positive Rectification This rectifies the waveform so that its phase is 100% positive. The audible effect is a doubling of the audio signal's frequency.

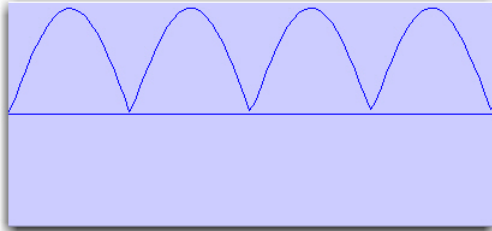

Positive rectification

Negative Rectification This rectifies the waveform so that its phase is 100% negative. The audible effect is a doubling of the audio signal's frequency.

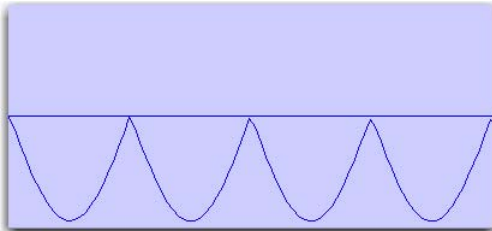

Negative rectification

Alternating Rectification This alternates between rectifying the phase of the first negative waveform excursion to positive, then the next positive excursion to negative, and so on, throughout the waveform. The audible effect is a halving of the audio signal's frequency, creating a subharmonic tone.

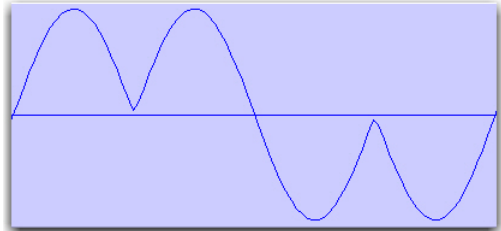

Alternating rectification

Alt-Max Rectification This alternates between holding the maximum value of the first positive excursion through the negative excursion period, switching to rectify the next positive excursion, and holding its peak negative value until the next zero crossing. The audible effect is a halving of the audio signal's frequency, and creating a subharmonic tone with a hollow, square wave-like timbre.



Alt-Max rectification

Recti-Fi Gain Control

Gain lets you adjust signal level before the audio reaches the Post-Filter. This is particularly useful for restoring unity gain if you have used the Pre-Filter to cut off high frequencies prior to rectification. The range of this control is from -18dB to $+18\text{dB}$.

Recti-Fi Post-Filter

Waveform rectification, particularly alternating rectification, typically produces a great number of harmonics. The Post Filter control lets you remove harmonics above the cutoff frequency and smooth out the sound. This is useful for filtering audio that contains subharmonics. To create classic subharmonic synthesis effects, set the Pre-Filter and Post-Filter to a relatively low frequency.

The range of the Post-Filter control is 43 Hz to 22 kHz, with a maximum value of Thru (which effectively means bypass).

Recti-Fi Mix Control

Mix adjusts the mix of the rectified waveform with the original, unprocessed waveform.

Recti-Fi Output Meter

The Output Meter indicates the output level of the processed signal. Note that this meter indicates the output level of the signal—not the input level. If this meter clips, the signal may have clipped on input before it reached Recti-Fi. Monitor your send or insert signal levels closely to prevent this from happening.

Chapter 49: Reel Tape Saturation

Reel Tape Saturation is part of the Reel Tape suite of tape-simulation effects plug-ins. Reel Tape Saturation simulates the saturation effect of an analog tape machine, modeling its frequency response, noise and distortion characteristics, but without any delay or wow and flutter effects.

Reel Tape Saturation is available in DSP, Native, and AudioSuite formats.

Reel Tape Saturation supports 44.1 kHz, 48 kHz, 88.2 kHz, 96 kHz, 176.4 kHz and 192 kHz sample rates.

Reel Tape Saturation operates as a mono, multi-mono, or stereo plug-in.



Reel Tape Saturation

For years, engineers have relied on analog tape to add a smooth, warm sound to their recordings. When driven hard, tape responds with gentle distortion rather than abrupt clipping as in the digital domain. Magnetic tape also has a frequency-dependent saturation characteristic that can lend punch to the low end, and sweetness to the highs.

Reel Tape Saturation models the sonic characteristics of analog tape, including the effects of tape speed, bias setting, and calibration level of the modeled tape machine.

Reel Tape Saturation can be placed on mono, stereo, or multichannel tracks.

Reel Tape Common Controls

All Reel Tape plug-ins share the following controls:

Drive

Drive controls the amount of saturation effect by increasing the input signal to the modeled tape machine while automatically compensating by reducing the overall output. Drive is adjustable from -12 dB to $+12$ dB, with a default value of 0 dB.

Output

Output controls the output signal level of the plug-in after processing. Output is adjustable from -12 dB to $+12$ dB, with a default value of 0 dB.

Tape Machine

The Tape Machine control lets you select one of three tape machine types emulated by the plug-in, each with its own sonic characteristics:

US Emulates the audio characteristics of a 3M M79 multitrack tape recorder.

Swiss Emulates the audio characteristics of a Studer A800 multitrack tape recorder.

Lo-Fi Simulates the effect of a limited-bandwidth analog tape device, such as an outboard tape-based echo effect.

Tape Formula

The Tape Formula control lets you select either of two magnetic tape formulations emulated by the plug-in, each with its own saturation characteristics:

Classic Emulates the characteristics of Ampex 456, exhibiting a more pronounced saturation effect.

Hi Output Emulates the characteristics of Quantegy GP9, exhibiting a more subtle saturation effect.

Reel Tape Saturation Controls

In addition to the Drive, Output, Tape Machine, and Tape Formula controls, Reel Tape Saturation has the following controls:

Speed

The Speed control adjusts the tape speed in ips (inches per second). Tape speed affects the frequency response of the modeled tape machine. Available tape speeds include 7.5 ips, 15 ips, and 30 ips, with a default setting of 15 ips.

Noise

Reel Tape Saturation produces noise only during playback and recording, and not when the transport is stopped.

The Noise control adjusts the level of simulated tape noise that is added to the processed signal. The characteristics of the noise depend on the Speed, Bias, and Tape Machine settings, and the relative level of the noise depends on the Drive, Cal Adjust, and Tape Formula settings.

Noise is adjustable from Off (–INF) to –24 dB, with the default value being Off.

Bias

The Bias control simulates the effect of under- or over-biasing the modeled tape machine. Bias is adjustable from –6 dB to +6 dB, with a default value of 0.0 dB. The 0.0 dB value represents a standard overbias calibration of 3 dB for analog tape machines, so the control acts as a bias offset rather than as an absolute bias control.

Cal Adjust

Cal Adjust simulates the effect of three common calibration levels on the modeled tape machine and magnetic tape formulations.

With the evolution of tape formulations, it was possible to increase the fluxivity level, or magnetic strength, of the signals on tape. Over the years, this resulted in an elevation of recorded levels relative to a standard reference fluxivity (185 nW/m at 700 Hz). The Cal Adjust value expresses the elevated level in dB over this standard reference level.

The Cal Adjust control does not affect the overall gain, but does affect the amount of saturation effect for a given input signal.

Available Cal Adjust values are:

- +3 dB (equivalent to 250 nW/m)
- +6 dB (equivalent to 370 nW/m)
- +9 dB (equivalent to 520 nW/m)

The default value is +6 dB.

Reel Tape Saturation Tips

- ◆ Use Reel Tape Saturation on individual tracks to round out sharp transients or add color to sustained tones.
- ◆ Use Reel Tape Saturation on a group of tracks (for example drums) to add cohesiveness to the sound of the group.
- ◆ Use Reel Tape Saturation on a Master Fader to apply analog tape-style compression to a mix.

Reel Tape Saturation Presets

The sonic effect of Reel Tape Saturation depends on many factors, including the signal level of the source material; these presets are just starting points. With some experimentation, Reel Tape Saturation can yield warmer-sounding results than conventional digital compression.

Bass Drum Rounds out and adds consistency to bass drum hits.

Bass Gtr Adds consistency and warmth to bass guitar sound while avoiding compression artifacts

Snare Drum Reduces harsh peaks resulting from EQ-boosted snare drum or rim shots.

Chapter 50: SansAmp PSA-1

SansAmp PSA-1 is a guitar amp simulator plug-in. Punch up existing tracks or record great guitar sounds with the SansAmp PSA-1. Capture bass or electric guitar free of muddy sound degradation and dial in the widest range of amplifier, harmonic generation, cabinet simulation and equalization tone shaping options available! Tube sound, speaker simulation, warm equalization and cool lo-fi textures—no wonder thousands of records feature the classic sounds of SansAmp!



SansAmp PSA-1

SansAmp PSA-1 is available in DSP, Native, and AudioSuite formats.

SansAmp PSA-1 supports 44.1 kHz, 48 kHz, 88.2 kHz, 96 kHz, 176.4 kHz and 192 kHz sample rates.

SansAmp PSA-1 operates as a mono, multi-mono, or stereo plug-in.

B. Andrew Barta of Tech 21, Inc. introduced the SansAmp Classic in 1989. A guitar player with both a trained ear and electronics expertise, Andrew and Tech 21 pioneered the market for tube amplifier emulation.

SansAmp's FET-hybrid circuitry emulation captures the low-order harmonics and sweet overdrive unique to tube amplifiers. And pushed harder, SansAmp also generates cool lo-fi and grainy sound textures that still retain warmth.

SansAmp also features a proprietary speaker simulator which emulates the smooth, even response of a multiple-miked speaker cabinet—free of the harsh peaks, valleys and notches associated with single miking or poor microphone placement.

Finally, SansAmp provides two extremely sweet sounding tone controls (high and low) that sound great on most anything.

PSA-1 Controls

Use the eight knobs to dial in your tone or effect.

Pre-Amp

Determines the input sensitivity and pre-amp distortion. Increasing the setting produces an effect similar to putting a clean booster pedal ahead of a tube amp, overdriving the first stage. For cleaner sounds, use settings below the unity-gain point.

Buzz

Controls low frequency break up and overdrive. Boost the effect by turning clockwise from the center point indicated by the arrows. As you increase towards maximum, the sound becomes (you guessed it) buzzy, with added harmonic content. For increased clarity and definition when using distortion, position the knob at its midpoint or towards minimum.

Punch

Sets midrange break up and overdrive. Decreasing from the center produces a softer, “Fender”-style break up. Increasing the setting produces a harder, heavier distortion. At maximum, it produces a sound similar to a wah pedal at mid-boost position placed in front of a Marshall amp.

Crunch

Brings out upper harmonic content and, on guitars, pick attack. For cleaner sounds or smoother high end, decrease as needed.

Drive

Increases the amount of power amp distortion. Power amp distortion is associated with the “Vintage Marshall” sound—using SansAmp, you can produce the effect even at low levels.

Low

Provides a tone control specially tuned for maximum musicality when used to EQ low frequencies on instruments. Boost or cut by ± 12 dB by turning from the center point indicated by the arrows.

High

Boosts or cuts high frequencies by ± 12 dB.

Level

Boosts or cuts the overall gain to re-establish unity after adding distortion or equalizing the signal.

PSA-1 Tips and Tricks

Peace and Unity

The arrows in the SansAmp controls indicate the unity-gain position.

Louder and Cleaner

For best results, don’t set the Pre-Amp level lower than unity gain when the Drive knob is at 9 o’clock or higher. However, if you want a crystal-clear sound and the Drive control is already near minimum, decrease Pre-Amp to further remove distortion.

Pre-Amp Versus Drive

To create varying types of overdrive, vary Pre-Amp in relation to Drive. A high Pre-Amp setting emphasizes pre-amp distortion (see “Mark 1” preset), while high Drive settings emphasize power amp distortion (see “Plexi” preset).

Part IX: Dither Plug-Ins

Chapter 51: Dither

Dither is a dither-generation plug-in. The Dither plug-in minimizes quantization artifacts when reducing the bit depth of an audio signal to 16-, 18-, or 20-bit resolution.

Dither is available in DSP and Native formats.

Dither supports 44.1 kHz, 48 kHz, 88.2 kHz, 96 kHz, 176.4 kHz and 192 kHz sample rates.

Dither operates as a mono, multi-mono, or stereo plug-in.



Dither

Whenever you are mixing down or bouncing to disk and your destination bit depth is lower than 24-bit, insert a dither plug-in on a Master Fader track that controls the output mix.

Using a dither plug-in on a Master Fader is preferable to an Auxiliary Input because Master Fader inserts are post-fader. As a post-fader insert, the dither plug-in can process changes in Master Fader level.

 *For more information on using dither plug-ins in Pro Tools, see the Pro Tools Reference Guide.*

The Dither plug-in has user-selectable bit resolution and a noise shaping on/off option.

 *If you are mixing down to an analog destination with any 24-bit capable interface, you do not need to use Dither. This allows maximum output fidelity from the 24-bit digital-to-analog converters of the interface.*

Dither Controls

The Dither plug-in has a Bit Resolution button and a Noise Shaping button.

Bit Resolution Button

Use this pop-up menu to choose one of three possible resolutions for the Dither processing. Set this control to the maximum bit resolution of your destination.

16-bit Recommended for output to digital devices with a maximum resolution of 16 bits, such as DAT and CD recorders.

18-bit Recommended for output to digital devices with a maximum resolution of 18 bits.

20-bit Recommended for output to digital devices that support a full 20-bit recording data path, such as the Sony PCM-9000 optical mastering recorder, or the Alesis ADAT XT 20. The 20-bit setting can also be used for output to digital effects devices that support 20-bit input and output, since it provides for a lower noise floor and greater dynamic range when mixing 20-bit signals directly in Pro Tools.

 *The Dither plug-in only provides eight channels of uncorrelated dithering noise. If Dither is used on more than eight tracks, the dithering noise begins to repeat and dither performance is impaired. For example, if two Quad Dithers are used, both Quad instances of Dither will have all of their dither noise uncorrelated. However, any additional instances of the Dither plug-in will begin to repeat the dithering noise.*

Noise Shaping Button

The Noise Shaping button engages or disengages Noise shaping. Noise shaping is on when the button is highlighted in blue.

Noise shaping can further improve audio performance and reduce perceived noise inherent in dithered audio. Noise shaping uses filtering to shift noise away from frequencies in the middle of the audio spectrum (around 4 kHz), where the human ear is most sensitive.

Chapter 52: POW-r Dither

POW-r Dither is a dither-generation plug-in. The POW-r Dither plug-in is an advanced type of dither that provides optimized bit depth reduction. It is designed for final-stage critical mixdown and mastering tasks where the highest possible fidelity is required when reducing bit depth.

POW-r Dither is available in DSP and Native formats.

POW-r Dither supports 44.1 kHz, 48 kHz, 88.2 kHz, 96 kHz, 176.4 kHz and 192 kHz sample rates.

POW-r Dither operates as a mono, multi-mono, or stereo plug-in.



POW-r Dither

POW-r Dither Controls

POW-r Dither provides a variety of controls for adjusting plug-in parameters.

Bit Resolution

Use this pop-up menu to choose either 16- or 20-bit resolutions for POW-r Dither processing. Set this control to the maximum bit resolution of your destination.

16-bit Recommended for output to digital devices with a maximum resolution of 16 bits, such as DAT and CD recorders.

20-bit Recommended for output to devices that support a full 20-bit recording data path.

Noise Shaping

Noise shaping can further improve audio performance and reduce perceived noise inherent in dithered audio. Noise shaping uses filtering to shift noise away from frequencies in the middle of the audio spectrum (around 4 kHz), where the human ear is most sensitive.

⚠ *The POW-r Dither plug-in is not appropriate for truncation stages that are likely to be further processed. It is recommended that POW-r Dither be used only as the last insert in the signal chain (especially when using Type 1 Noise Shaping).*

The POW-r Dither plug-in provides three types of noise shaping, each with its own characteristics. Try each noise shaping type and choose the one that adds the least amount of coloration to the audio being processed.

Type 1 Has the flattest frequency spectrum in the audible range of frequencies, modulating and accumulating the dither noise just below the Nyquist frequency. Recommended for less stereophonically complex material such as solo instrument recordings.

Type 2 Has a psychoacoustically optimized low order noise shaping curve. Recommended for material of greater stereophonic complexity.

Type 3 Has a psychoacoustically optimized high order noise shaping curve. Recommended for full-spectrum, wide-stereo field material.

 *For more information on using dither plug-ins in Pro Tools, see the Pro Tools Reference Guide.*

Part X: Sound Field Plug-Ins

Chapter 53: AutoPan

AutoPan is an automatic panning plug-in that is available in DSP and Native formats. AutoPan pans a mono input to a multichannel (stereo, LCR, quad, or 5.0) output based on a LFO, envelope follower, MIDI Beat Clock, or manual automation. AutoPan is ideal for rhythmic panning effects based on your Pro Tools session tempo. It also provides an easy and elegant way to automate panning to multichannel surround formats for post-production.



AutoPan

AutoPan Controls

AutoPan provides output meters, panner controls, LFO controls, tempo controls, and envelope controls.

AutoPan Output Meters

The Output meters display the amplitude of the outgoing audio. In mono-to-stereo mode, a two meter bar is shown. In mono-to-LCR, quad, or 5.0 mode, three, four, or five channels are shown respectively.



Output meters (L, C, R, Ls, Rs)

The Clip indicator lights red when the channel has clipped. The clip indicator for each channel can be cleared by clicking it.

AutoPan Panner Controls

The Panner section provides different controls for different output channel configurations. AutoPan in mono-to-stereo and mono-to-LCR formats provide controls common to all output configurations: Output, Width, and Manual. AutoPan mono-to-quad and mono-to-5.0 formats provide additional controls depending on the Path selection: Angle and Place, or Spread. Additionally, the Panning Source selector, Panning display, and Path selectors are common to all output channel configurations.

Output

The Output slider lets you cut or boost the output signal level from -24 dB to $+12$ dB.



Panner section, mono-to-stereo, left to right path selected

Width

The Width slider controls the width of the panning field. At 100%, the panning field is at its widest. At 0%, the panning field is centered and stationary. The Width slider effectively determines the amount of LFO or Envelope control on the pan position.

Manual

The Manual slider directly controls the pan position, this lets you manually control the pan position from a control surface or by using automation. The amount of manual control is affected by the setting of the Width slider. For full manual control, set the

Width slider to 0%. When the Width slider is at 100%, the Manual slider has no effect on the pan position. When Width is set to 50%, the LFO sweeps the position through 50% of its range and the Manual slider lets you move the position of that 50% range.

Angle

The Angle slider adjusts the orientation of the panning field from -90° to $+90^\circ$. At 0° , the panning field is oriented strictly left/right. At -90° or $+90^\circ$, the panning field is oriented strictly front/back.



Panner section, mono-to-5.0, left to right path selected

The Angle slider is only available with mono-to-quad and mono-to-5.0 formats, and a left to right or right to left path selected.

Place

The Place slider adjusts the front/back placement of the panning field. At 0%, the panning field is centered front/back. At $+100\%$, it is placed all the way front. At -100% , it is placed all the way back.

The Place slider is only available with mono-to-quad and mono-to-5.0 formats, and a left to right or right to left path selected.

Spread

The Spread slider opens or constricts the field of panning. At 100%, the spread of the panning field is at its greatest. At 0%, the spread of the panning field is completely constricted, and the sound is centered and stationary (left/right and front/back).



Panner section, mono-to-5.0, clockwise path selected

The Spread slider is only available with mono-to-quad and mono-to-5.0 formats, and a circular path (clockwise or counterclockwise) selected.

Panning Source

Click LFO or Env to select the source for panning. When the Source is set to LFO, panning is controlled by the LFO and its controls (see “AutoPan LFO Controls” on page 322). When the Source is set to Envelope (Env), panning is controlled by the Envelope Detector and its controls (see “AutoPan Envelope Controls” on page 324). The Envelope Detector can be triggered by the panned audio signal, or by a side-chain input (see “Using the Side-Chain Input” on page 325).



Panning Source buttons

Panning Display

The Panning display graphically represents the panning field and the location of the sound source within that field.



Panning display, mono-to-5.0, left to right path selected

Sound Location Indicator This bright yellow light indicates the location of the sound source.

Panning Field Indicator This is the grey line on which the yellow Sound Location indicator travels and indicates the panning field.

Path

The Path selectors determine whether the audio signal pans left to right, right to left, or in a circular motion clockwise, or counterclockwise. The circular path selectors (clockwise and counterclockwise) are only available with mono-to-quad and mono-to-5.0 formats.



Path selectors, left to right path selected

AutoPan LFO Controls

The LFO section provides controls for the Low Frequency Oscillator that can be used to modulate panning. The controls in the LFO section only affect the panning if LFO is selected as the panning source in the panning section (see “Panning Source” on page 321).



LFO section

⚠ *When the Panner section is set to Envelope (Env), the controls in the LFO section have no effect on panning.*

Rate

The Rate slider adjusts the rate of the LFO in beats per minute. When Link to Tempo is activated, the slider is ignored and the Tempo display always shows the current session tempo (see “Tempo Display” on page 324).

Waveform

The Waveform selector determines the wave shape used by the LFO. The waveform shape in use is graphically depicted by the movement of the Sound Location indicator in the Panning display.



Selecting the LFO Waveform

LFO Triggers

By default, the LFO cycles continuously through the selected waveform. The LFO can be set to cycle through the selected waveform just once, or it can be triggered by MIDI Beat Clock, the Envelope, or manually.



LFO Triggers

Single When the Single trigger is selected, the LFO will cycle through the waveform once only and then stop.

Beat Clock When the Beat Clock trigger is selected, the LFO synchronizes to MIDI Beat Clock. TL AutoPan receives Beat Clock signal every 64th-note. The Duration menu determines how often the Beat Clock signal triggers TL AutoPan, ranging from every 16th-note to every 4 bars. When Beat Clock signal is received, the Beat Clock trigger light blinks brightly. Using the Beat Clock function enables TL AutoPan to produce consistent panning results, ensuring that the LFO is always in the same state at each beat.

Envelope When the Envelope trigger is selected, the LFO is triggered directly by the Envelope Detector, which analyzes the amplitude of the audio signal. If the Side-Chain Input selector in the Envelope section is activated, then the side-chain audio signal is used instead. When activated, the Envelope light blinks brighter when an audio signal is detected. The threshold level can be adjusted using the Threshold control in the Envelope section.

If the Envelope Detector is completely released due to previous portions of the audio signal going above threshold, a trigger occurs the next time the audio goes above the threshold level. Another trigger will not happen until the Envelope Detector has completely released after the audio goes below the specified threshold. Increasing the release time reduces the rate at which triggers can occur and decreasing the release time increases the rate at which triggers can occur.

Manual When the Manual trigger is selected, the LFO is triggered manually. This can be especially useful if you want to trigger the LFO using Pro Tools automation.

With control surfaces and automation, the Manual trigger acts like an on/off switch and triggers the LFO every time it changes state.

AutoPan Tempo Controls

Link To Tempo

When the Link To Tempo option is enabled, the LFO rate is set to the Pro Tools session tempo, and any tempo changes in the session are followed automatically. In addition, the LFO rate slider is ignored and the Tempo display always shows the current session tempo.

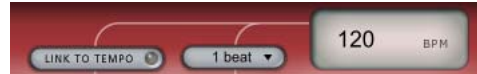

Tempo controls

Duration Selector

The Duration selector works in conjunction with the session tempo, LFO rate, and Beat Clock trigger. By default, Duration is set to 1 bar. At that setting, the LFO cycles once within one bar. When Duration is set to 1 beat, the LFO cycles within the duration of one beat. When Link to Tempo is enabled, the Duration menu allows the LFO rate to be set as a function of the tempo of the Pro Tools session. The Duration menu also controls how often the Beat Clock trigger is activated.

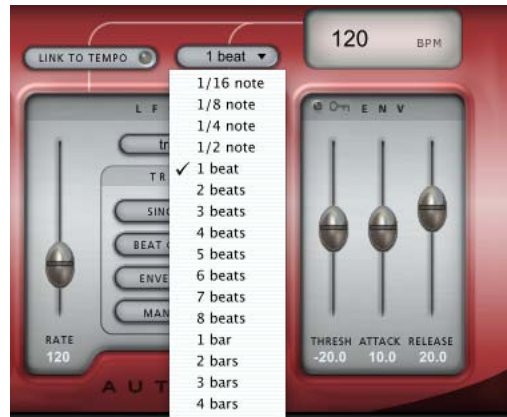

Selecting Duration

Tempo Display

The Tempo display shows the tempo in BPM. The value in the Tempo display can also be edited directly by clicking it and typing a new value.

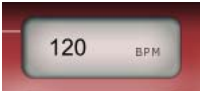

Tempo display

AutoPan Envelope Controls

When Envelope (Env) is selected as the Panning source, Panning (as shown in the Panning display) is controlled by the audio signal and the Envelope section controls.



Envelope section

⚠ *When Envelope (Env) is not selected as the Panning Source, the controls in this section have no effect on the sound.*

Side-Chain Input

When the Side-Chain Input selector (the key icon) is enabled, the audio for the Envelope Detector is taken from the side-chain input rather than the current track. Select the Side-Chain Input using the Pro Tools Key Input selector at the top of the plug-in window.



Side-Chain Input selector enabled

Threshold

The Threshold slider sets the amplitude level required for the Envelope Detector. The LFO Envelope Detector light blinks brighter when audio is detected above the threshold.

Attack

The Attack slider sets the attack rate of the Envelope Detector.

Release

The Release slider sets the release rate of the Envelope Detector.

Using AutoPan

AutoPan can be used for dynamic panning effects based on a Low Frequency Oscillator (LFO), an amplitude envelope (ENV), or manual control.

AutoPan makes it easy to pan to the beat of a music track, as well as panning “fly-around” effects. The following section describes two possible scenarios for using AutoPan: panning to the beat for rhythmic panning effects and surround panning effects for post production.

Panning to the Beat

AutoPan lets you synchronize the LFO to MIDI Beat Clock for rhythmic panning effects.

To synchronize AutoPan to MIDI Beat Clock:

- 1 Make sure that your session tempo matches the tempo of the music.
- 2 Insert a mono-to-stereo instance of AutoPan on the mono audio track containing the audio you want to pan. The track’s channel width changes from mono-to-stereo.

- 3 In the AutoPan Plug-In window, enable Link To Tempo. This sets the LFO rate to follow the session tempo.
- 4 Select a duration from the Duration selector. For example, select 2 Beats.
- 5 Select a waveform for the LFO from the Waveform selector. For example, select 4 Step Triangle.
- 6 Enable Beat Clock for the LFO Trigger. This ensures that the LFO is synchronized to the beat.
- 7 Play back the session to hear the panning effect.

Post Production Panning (Pro Tools HD Only)

AutoPan lets you pan a mono track to a greater than stereo (LCR, Quad, or 5.0) output in a surround path. This is especially useful for post-production applications. The following example describes how to use TL AutoPan to pan a “mosquito” sound in 5.0 surround.

To pan a mono track to 5.0 with AutoPan:

- 1 Insert a mono-to-5.0 instance of AutoPan on the mono track containing the audio you want to pan. The track’s channel width changes from mono-to-5.0.
- 2 Select a 5.0 output path from the track’s Output selector.

- 3 In the AutoPan Plug-In window, select a clockwise or counter-clockwise Path.
- 4 Adjust the Spread and Width sliders.

 Try automating Spread and Width to alter the positioning of the panned sound.

- 5 From the LFO Waveform selector, select Half Sine.

 Try automating the Manual control instead of using the LFO to create a more erratic panning of the “mosquito” sound.

- 6 Adjust the Rate slider.

 Try automating Rate to alter the speed of the panned sound over time.

- 7 Play back the session to hear the “mosquito” flying around your head.

Using the Side-Chain Input

The Side-Chain Input option in AutoPan lets you direct audio from another track in your Pro Tools session to the Envelope Detector. This is achieved by sending the audio from a channel to a bus and setting the side-chain input on AutoPan to the same bus.

 For more information on using the Side-Chain Input, see the Pro Tools Reference Guide.

Chapter 54: Down Mixer

Avid Down Mixer can be used to automatically mix greater-than-stereo multichannel tracks (such as 5.1) down to stereo (Pro Tools HD only) or stereo tracks down to mono.

Down Mixer is available in DSP and Native formats.

Down Mixer supports 44.1 kHz, 48 kHz, 88.2 kHz, 96 kHz, 176.4 kHz and 192 kHz sample rates.



Down Mixer (5.1 to Stereo)

Down Mixer supports the following greater-than-stereo multichannel formats:

- LCR
- LCRS
- 5.0
- 5.1
- 7.1 SDDS
- 7.1

When inserting Down Mixer on a compatible greater-than-stereo multichannel track, the channel format of the track output changes to stereo.

When inserting Down Mixer on a stereo track, the channel format of the track output changes to mono.



Avid Down Mixer (Stereo to Mono)

Source

The Source section of the Down Mixer plug-in provides controls that let you mute, invert the phase, and adjust the level of each input channel to the Down Mixer.

Mute

When enabled, the Mute button mutes the channel input to the Down Mixer.

Phase

When enabled, the Phase button inverts the phase of the channel input to the Down Mixer.

Level

You can adjust the level of the channel input to the Down Mixer from -45 dB to $+12$ dB. For stereo to mono down mixing, both the Left and Right channels are mixed to summed mono. For greater-than-stereo multichannel down mixing, the following rules apply:

- All left-channel sources (L, Lc, Ls, Lss, Lsr) feed to the left channel (L) of the down mixer.
- All right-channel sources (R, Rc, Rs, Rss, Rsr) feed to the right channel (R) of the down mixer.
- The center channel (C) and low-frequency channel (LFE) are panned center into the stereo field of the down mixer.

Meter

The level meters for source channels always show the input level (pre-fader) for the channel regardless of the Source Level setting.

Downmix

The Downmix section of the Down Mixer plug-in provides output meters and a single fader to adjust the output level of the Down Mixer from -45 dB to $+12$ dB.

Part XI: Instrument Plug-Ins

Chapter 55: Click II

Click II is a metronome plug-in. The Click II plug-in creates an audible click during session playback that you can use as a tempo reference when performing and recording. The Click II plug-in receives its tempo and meter data from the Pro Tools application, letting it follow any changes in tempo and meter in a session. The Click II plug-in is a Native mono-only plug-in. Several click sound presets are included.

Click II supports 44.1 kHz, 48 kHz, 88.2 kHz, 96 kHz, 176.4 kHz and 192 kHz sample rates.



Click II

! *Click II does not sound if the Click option is disabled (Options > Click) or if the Click track has been muted.*

Click II Controls and Displays

Click II provides displays for the session Meter and Tempo settings (which can be set manually in the Transport window or can follow the conductor rulers for Meter and Tempo in the session Timeline).

Beat Display

The Beat display shows the number of beats in a bar as determined by the Meter for the session. If the session contains meter changes, the Beat display shows the number of beats in a bar for the Meter at the current location of the Playback Cursor.

Follow Meter

When the Follow Meter option is enabled (highlighted), Click II follows the Meter track for the session. If this option is disabled (un-highlighted), you can set the rhythmic values for Click 1 and Click 2 independently of the Meter track.

To enable (or disable) the Follow Meter option:

- Click the Follow Meter toggle below the Beat display.

BPM Display

The BPM display shows the current tempo in the session. If Tempo is set manually, with the Conductor track disabled, the tempo as set in the Transport window is displayed. If the Conductor track is enabled, the Tempo at the current location of the Playback Cursor is displayed.

ON Button and MIDI IN LED

Click the ON button to manually turn the Click on or off. It is on when it is lit. Just below the ON button is an LED that illuminates each time the Click plug-in receives a click message from the Pro Tools application, indicating the click tempo.

Click 1

The Click 1 section provides controls for the downbeat click.

Accent Fader

The Accent fader lets you set the relative strength of the accent (output MIDI velocity) for the downbeat click.

Click Sound Selector

You can choose from several click sound options using the Click Sound selector.

Click Beat Value

If the Follow Meter option is disabled, you can manually set the rhythmic value for the downbeat click. If the Follow Meter option is enabled, the Click Beat Value options are grayed out.

To set the Click Beat Value independently of the Meter track:

- 1 Ensure that the Follow Meter option is disabled.
- 2 Click to select a rhythmic value for the downbeat click (whole, half, quarter, eighth, or sixteenth note).
- 3 Click to select (or deselect) the triplet or dot modifier for the beat value.



The Click Beat Value options can be automated to support the appropriate accent patterns for different meters for the click.

Click 2

The Click 2 section provides the same controls as the Click 1 section, but for all beats other than the downbeat.

Creating a Click Track

To create a click track with the Click II plug-in:

- 1 Ensure that the Options > Click is enabled.
- 2 Choose Track > Create Click Track.

Pro Tools creates a new Auxiliary Input track named “Click” with the Click II plug-in already inserted. In the Edit window, the track’s Track Height is set to Mini.

To manually create a click track with the Click plug-in:

- 1 Select Options > Click to enable the Click option (or enable the Metronome button in the Transport).
- 2 Create new a mono Auxiliary Input track and insert the Click II plug-in.
- 3 Select a click sound preset.
- 4 Choose Setup > Click/Countoff and set the Click and Countoff options.

⚠ *The Note, Velocity, Duration, and Output options in this dialog are for use with MIDI instrument-based clicks and do not affect the Click II plug-in.*

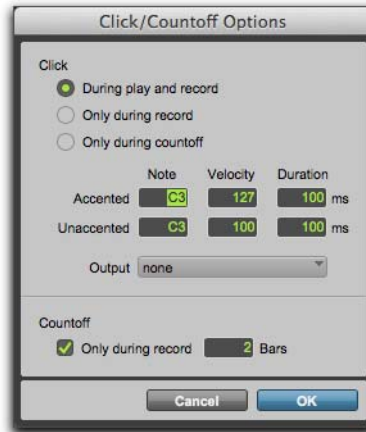

Click Options dialog

- 5 Begin playback. A click is generated according to the tempo and meter of the current session and the settings in the Click/Countoff Options dialog.

 *See the Pro Tools Reference Guide for more information on configuring Click options.*

Chapter 56: ReWire

Pro Tools supports ReWire version 2.0 technology developed by Propellerheads Software. ReWire is available in Pro Tools using the ReWire Native plug-in.

ReWire provides real-time audio and MIDI streaming between applications, with sample-accurate synchronization and common transport functionality.



ReWire

Using ReWire, Pro Tools can send and receive MIDI to and from a ReWire client application, such as a software synthesizer, and receive audio back from the ReWire client. Pro Tools applies MIDI time stamping to all incoming MIDI.

Compatible ReWire client applications are automatically detected by Pro Tools and are available in the Plug-Ins (Native) Insert menus in Pro Tools. Selecting a ReWire client application within Pro Tools automatically launches that application (if the client application supports this feature). Any corresponding MIDI nodes for that application are available in any Instrument track's MIDI Output selector (Instrument view) and any MIDI track's Output selector.

Once the outputs of your software synthesizers and samplers are routed to Pro Tools, you can:

- Process incoming audio signals with plug-ins
- Automate volume, pan, and plug-in controls
- Bounce To Disk
- Take advantage of the audio outputs of your Pro Tools audio interfaces

! *Pro Tools does not support sending audio to ReWire client applications.*

! *Not all ReWire client applications support automatic launch from a ReWire-mixer application. For these applications, launch the ReWire client app separately, and then select it as a plug-in insert in Pro Tools.*

! *Exchange of additional metadata such as controller and note names between Pro Tools and ReWire clients is not supported.*

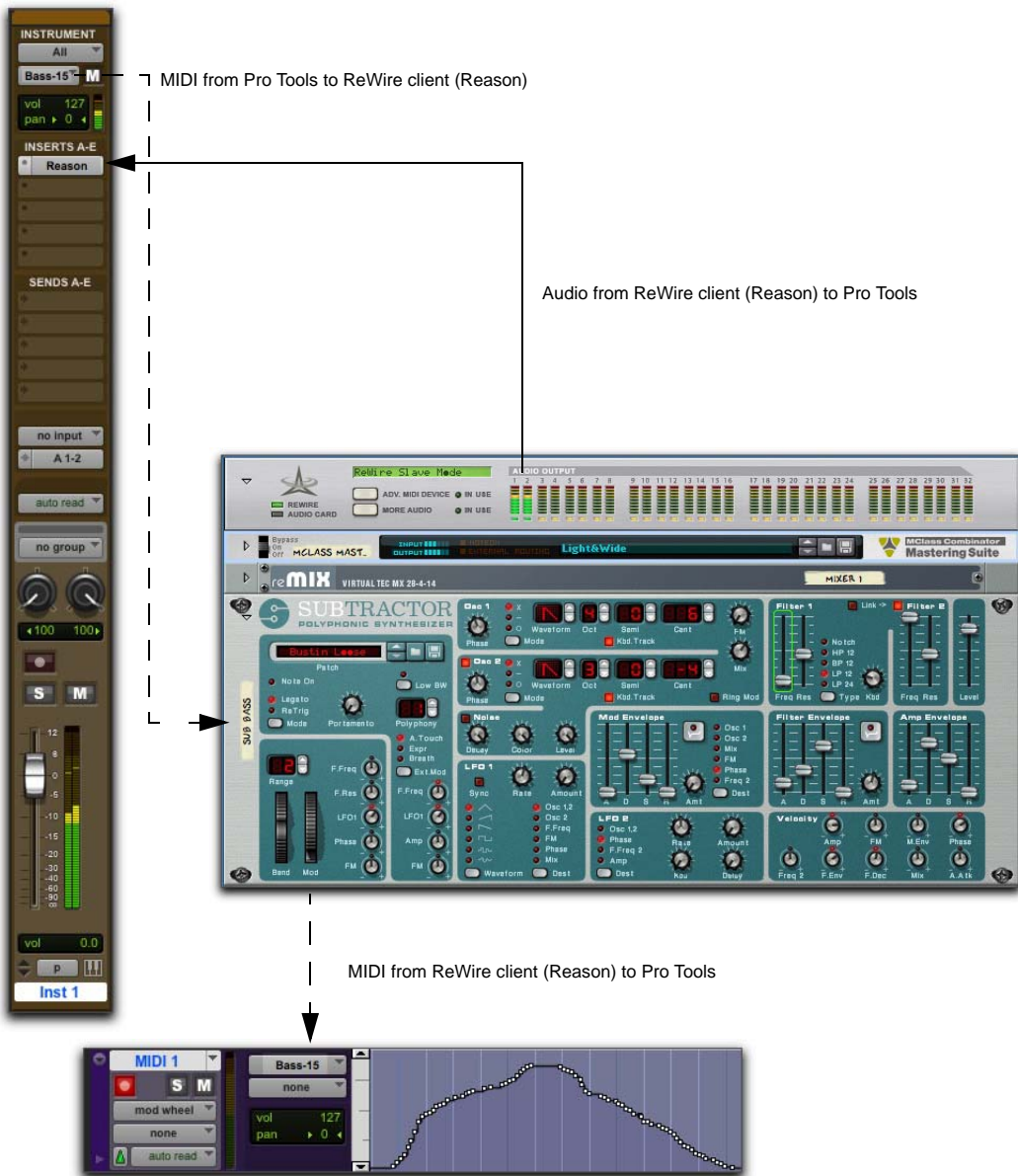

Audio and MIDI signal flow between Pro Tools and a ReWire client application (Reason shown)

ReWire Requirements

To use the ReWire plug-in, you will need:

- An Avid-qualified Pro Tools system
- 64-bit ReWire-compatible client software (such as *Reason* from Propellerheads Software)

 *Client software must support the same sample rate as the session using ReWire. For example, third-party client software that does not support sample rates above 48 kHz cannot be used in a 96 kHz Pro Tools session.*

ReWire support is also under development for other third-party companies. For availability, check with the manufacturer or visit the Avid website (www.avid.com).

Track Count with Pro Tools HD

With Pro Tools HD, the ReWire plug-in can be inserted on any kind of track. Each channel of audio transmitted through ReWire then uses the same amount of resources as the audio track on which it is inserted.

Consequently, you can only use a total combination of audio track channels and ReWire audio streams that does not exceed the maximum number of possible voices for your system. For example, if you are playing 96 stereo audio tracks in a 48 kHz/24-bit session on a system that supports 256 voices at that sample rate, another 64 channels of audio will be available for use with ReWire. However, note that ReWire only supports a maximum of 64 audio streams per host application.

Using ReWire at higher sample rates will increase the load on the CPU. For example, CPU load at 96 kHz is double the load at 48 kHz. You can monitor Pro Tools CPU usage in the System Usage window, making sure to not overtax your system.



With Pro Tools HD, the standard Hardware Buffer size of 512 samples is recommended for using ReWire in sessions with sample rates above 48 kHz.

Track Count with Pro Tools Host-based Systems

With Pro Tools host-based systems, performance is determined by several factors, including host CPU speed, available memory, and buffer settings. Avid cannot guarantee 64 simultaneous audio channel outputs with ReWire on all computer configurations.

For the latest information on recommended CPUs and system configurations, visit the Avid website (www.avid.com).

Using ReWire

The ReWire plug-in is installed when you install Pro Tools. All inter-application communications between Pro Tools and ReWire client software is handled automatically.

To use a ReWire client application with Pro Tools:

- 1 In Pro Tools, choose Track > New and specify one Instrument track (or audio or Auxiliary Input track), and click Create.
- 2 In the Mix window, click the Insert selector on the track and assign the ReWire client plug-in to the track insert.

The ReWire client application launches automatically in the background (if the client applications supports auto-launch).

 *If the client application does not support auto-launch, launch it manually. Some ReWire client applications may need to be launched and configured before launching Pro Tools (such as Cycling 74 Max/MSP). Others may need to be launched after Pro Tools is launched (such as Ableton Live). For more information, refer to the manufacturer's documentation for your ReWire client application.*

- 3 Configure the ReWire client application to play the sounds you want.
- 4 In Pro Tools, set the output of the client application in the ReWire plug-in window. This is the audio output of the ReWire client to Pro Tools.

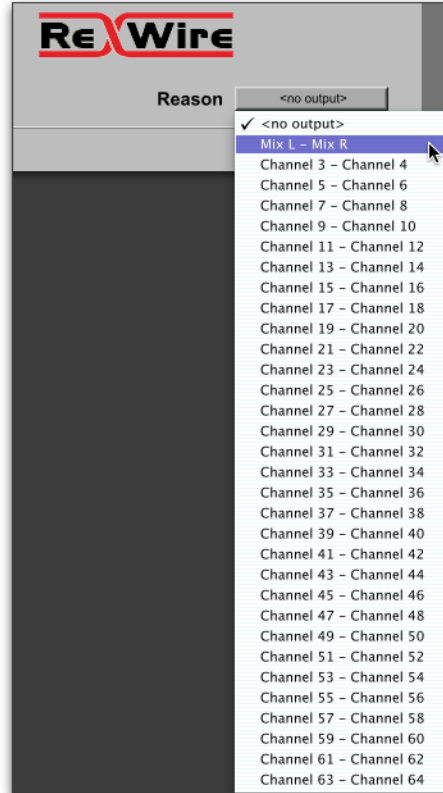

Selecting the audio output from a ReWire client

- 5 In the Mix window, click the track's MIDI Output selector and select the ReWire client application. Some ReWire clients (such as Reason) may list multiple devices. If so, choose the device that you want.



Selecting the ReWire client device to receive MIDI from Pro Tools (Instrument track shown)

- 6 Choose Options > MIDI Thru and record enable the MIDI track. Play some notes on your MIDI controller to trigger the client application. The selected ReWire device responds to MIDI sent from Pro Tools and plays back audio through the assigned Pro Tools track (Instrument, Auxiliary Input, or audio track).

If your ReWire client application is a sequencer and you want to begin synchronized playback with Pro Tools, press the Spacebar or click the Play button on the Pro Tools Transport.

MIDI Automation with ReWire

You can use Pro Tools MIDI tracks to record MIDI continuous controller (CC) data from a ReWire client application, and then play back MIDI from Pro Tools to send the recorded MIDI CC data back to the ReWire client application. In this way, you can adjust controls in the ReWire client application (using the mouse or an external MIDI controller) and record those changes in Pro Tools.

Recording MIDI Continuous Controller Data Over ReWire

The first step in automating a ReWire client application's controls is to record the CC data to a MIDI track in Pro Tools.

To record MIDI from a ReWire client application in Pro Tools:

- 1 In Pro Tools, create a new MIDI track.
- 2 From the track's MIDI Input selector, select the ReWire device that you want to record.

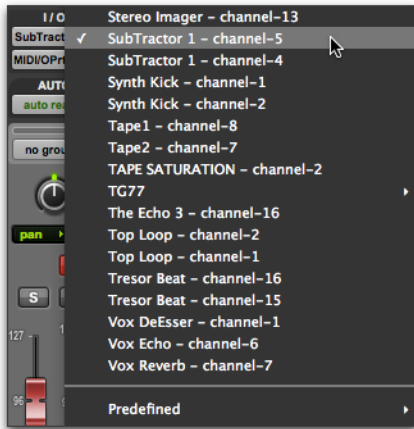

Selecting the ReWire client device to record MIDI CC data in Pro Tools

⚠ You must select the ReWire device from which you want to record MIDI controller data. Leaving the track's MIDI Input set to All does not record any MIDI data over ReWire.

- 3 Record enable the MIDI track.
- 4 Start recording in Pro Tools.
- 5 Switch to the ReWire client application.
- 6 Adjust the control for which you want to record MIDI CC data. Control changes are recorded to the Pro Tools MIDI track as CC data.



Adjusting a control in a ReWire client application (Reason's SubTractor shown)

💡 If your external MIDI controller is correctly mapped to the corresponding ReWire client application's controls, and it is correctly routed through Pro Tools, use your MIDI controller to adjust the parameter you want to record.

- 7 When you are done adjusting the control, return to Pro Tools and stop recording.
- 8 Record disable the MIDI track.
- 9 From the MIDI Track View selector in the Edit window, select the view for the CC data you just recorded.



MIDI CC data recorded from a ReWire client application

Playing Back MIDI Continuous Controller Data Over ReWire

Once you have recorded MIDI CC data from the ReWire client application to a MIDI track, configure the MIDI track to play the ReWire client application. You can also edit the MIDI CC data in Pro Tools until you achieve the best results.

To play back MIDI CC data over ReWire:

- 1 From the MIDI track's MIDI Output selector, select the ReWire client application device you want to control (the same device from which you recorded the MIDI CC data).
- 2 Start playback in Pro Tools.
- 3 Switch to the ReWire client application. Notice that the corresponding control changes according to the MIDI CC data from Pro Tools.

Quitting ReWire Client Applications

When quitting Pro Tools sessions that integrate ReWire client applications, quit the client application first, then quit Pro Tools.

 *If you quit Pro Tools before quitting ReWire client applications, a warning dialog may appear stating that “one or more ReWire applications did not terminate.” To avoid this, quit all ReWire client applications before quitting Pro Tools.*

Session Tempo and Meter Changes and ReWire

Pro Tools transmits both Tempo and Meter data to ReWire client applications, allowing ReWire-compatible sequencers to follow any tempo and meter changes in a Pro Tools session.

With the Pro Tools Conductor button selected, Pro Tools always acts as the Tempo master, using the tempo map defined in its Tempo Ruler.

With the Pro Tools Conductor button deselected, the ReWire client acts as the Tempo master. In both cases, playback can be started or stopped in either application.

 *Pro Tools supports tempo values from 30–300 bpm. When slaved to a ReWire client application, Pro Tools playback will be restricted to this range even if the client application's tempo is outside this range. Additionally, some ReWire client applications (such as Reason) may misinterpret Pro Tools meter changes, resulting in mismatched locate points and other unexpected behavior. To prevent this, avoid using meter changes in Pro Tools when using Reason as a ReWire client.*

Looping Playback with ReWire

Because Pro Tools does not offer separate loop markers as found in other third-party applications such as Reason, if you want to loop playback, do one of the following:

To loop playback in Pro Tools:

- 1 In the Pro Tools Timeline, select the time range that you want to loop.
- 2 Begin playback by pressing the Spacebar or clicking the Play button in the Transport.

To loop playback within a ReWire client sequencer

- With playback stopped, specify the loop within the ReWire client application and begin playback.

! *If you create a playback loop by making a selection in the Pro Tools Timeline, once playback is started, any changes made to loop or playback markers within the ReWire client application will deselect the Pro Tools Timeline selection and remove the loop.*

Automating Input Switching with ReWire

ReWire supports automation for switching inputs during playback.

To automate switching inputs during playback:

- 1 Set the track's automation to write.
- 2 Do one of the following:
 - Change the input link pop-up menu manually.
 - Draw the automation in the Edit window.

 *For information on drawing automation, see the Pro Tools Reference Guide.*

Part XII: Other Plug-Ins

Chapter 57: InTune

InTune is a professional instrument tuner plug-in that is available in DSP and Native formats. It offers the features and performance of a rack-mounted digital tuner in the convenience of a plug-in. InTune provides accurate and rapid tuning for a wide range of musical instruments, saving valuable studio time and adding a level of unprecedented convenience for musicians and audio engineers.

To use InTune with Pro Tools, simply create a new mono audio or Auxiliary Input track in Pro Tools, and select InTune from the plug-in menu for that track.

When InTune detects an audio signal from the track, the meter lights up and displays the relative pitch of the incoming signal. With stringed instruments, this will vary during the attack and decay of the note.

By default, InTune loads the Chromatic tuner preset. This displays all notes in the scale and automatically displays the required octave.

InTune provides a number of factory presets for stringed instruments in alternate tunings. Each factory preset is programmed with the specific notes for each string of the instrument in order to speed the tuning process, as well as making it easier for engineers to generate test tones for musicians to tune with.



InTune

InTune Controls and Displays

InTune Auto Button

Click the Auto button to toggle Automatic Mode on and off. When Automatic mode is active, InTune will detect the note played and automatically show the pitch for that note.

To enable Automatic mode:

- Click the Auto button to enable Automatic mode. The Auto button highlights.

To tune to a single note and turn off Automatic mode:

- Click the button for a note.



Selecting a note

This turns off automatic mode. InTune will now display pitch relative to the selected note only.

InTune Test Tone Menu Selector

InTune will generate both sine wave and triangle wave test tones as shown in the tone menu. The “Audible” tuning tone modulates the input signal against the reference tone.

To hear a test tone:

- 1 Select Sine, Triangle, or Audible from the Test Tone selector.



Selecting a test tone

- 2 Click the Note button for a note.
- 3 Adjust the Tone Volume slider.

When a test tone is playing, “Tone Playing” appears in the information display.

InTune Edit Button

Clicking the Edit button displays the Tuner Programming screen, where you can create customized tuning presets that display note selections for specific instruments and tunings. See “Creating InTune Tuning Presets” on page 344.

InTune Meter Selector

The Meter selector lets you use a standard needle style meter or a strobe style display.

To select the Meter display:

- Select Needle or Strobe from the Meter selector.



Selecting Meter display

Strobe Display



InTune, Strobe display

The Strobe display scrolls to the left when the tuned note is flat, and to the right when the tuned note is sharp. When the tuned note is close to the target note, the strobe slows to a stop. The information display shows the exact number of cents sharp or flat from the target note.

InTune Reference Frequency Control

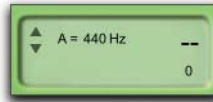

InTune, Reference Frequency

You can adjust the tuning reference frequency using the arrows inside the information display. By default, reference frequency is A=440 Hertz.

InTune Note Buttons

The Note buttons provide two functions:

- When in automatic mode, clicking on a note button will turn off automatic mode and InTune will now display pitch relative to the selected note only.
- When a tone is selected in the test tone menu, clicking on a note button will play a test tone for that note. Click the note button again to turn off the test tone.

The number of note buttons will depend on the preset selected. The default chromatic preset will display all twelve notes. A preset for a six string guitar will only display six notes.

Octave Buttons

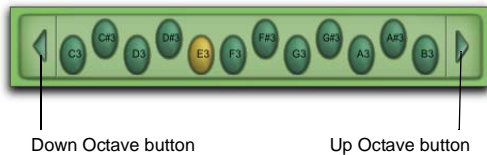

Octave buttons

The octave range of 0–8 displayed in InTune is based on middle C being equal to C4. In chromatic presets, you can select a tuning octave from 0–8 using the arrows at each end of the note display.

InTune Tone Volume

The Tone Volume slider controls the volume of the test tone audio signal.

InTune Information Display

The LCD style information display in InTune displays the following:

- The reference frequency
- The current note to which InTune is tuning
- The number of cents sharp or flat from the current note
- The status of any test tones playing

InTune Presets

InTune provides a selection of factory presets for stringed instruments. These presets can be selected from the Plug-In Librarian menu.

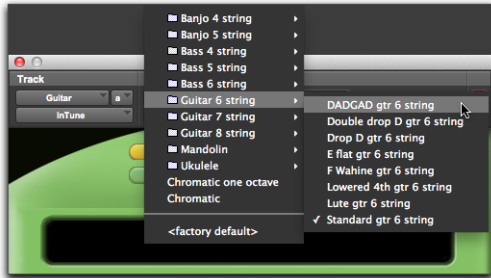

Selecting a InTune preset

To make any preset the default when InTune is instantiated:

- 1 From the Plug-In Librarian menu, select a preset.
- 2 From the Plug-In Settings menu, select Set As User Default.
- 3 From the Plug-In Settings menu, select Settings Preferences > Set Plug-In Default To > User Setting.

 For more information on using plug-in presets in Pro Tools, see the Pro Tools Reference Guide.

Creating InTune Tuning Presets

InTune lets you create customized tuning presets that display note selections for specific instruments and tunings. Once created, these tuning presets can be saved as part of a standard Pro Tools plug-in preset.

From the main InTune screen, click the Edit button to display the Tuner Programming screen.

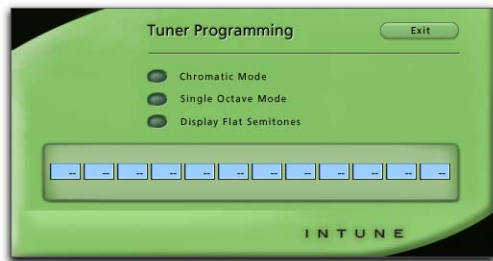

Tuner Programming

Chromatic Mode

When selected, Chromatic Mode overrides any custom note selections and displays a 12-note chromatic scale. The note entry fields are disabled when Chromatic Mode is selected.

Single Octave Mode

When selected, Single Octave Mode disables the display of octave information with each note on the main InTune screen. When tuning in this mode, InTune ignores the octave of the note being tuned. The octave information entered in the Edit screen is used only for generating test tones.

Single Octave Mode is typically used for instruments which generate harmonics in multiple octaves, such as bass guitars. Because of the low frequency waveform generated by a bass guitar, it is easier for InTune to tune to a higher harmonic of the note instead.

Display Flat Semitones

InTune will display all semitones entered into note fields as sharp by default. For example, a guitar tuned to E-flat is usually represented by the following.

Eb2, Ab2, Db3, Gb3, Bb3, Eb4

By default, if these notes are entered in the Edit screen, InTune will display these same notes in the following way.

D#2, G#2, C#3, F#3, A#3, D#4

The Display Flat Semitones option overrides the default behavior and displays semitones as flats, not sharps. It is not possible to display both sharp and flat semitones in the same tuning preset.

Note Entry Fields

The twelve note entry fields allow entry of individual notes from A0 to G7. Flat semitones are entered with a “b” (for example, Ab2), and sharp semitones are entered with a hash or pound character (for example, A#2). To clear an entry, enter “- -.”

Note fields are committed by pressing Return (Macintosh) or Enter (Windows). If you do not press Return or Enter, the note field will return to the previous value entered. InTune will automatically justify the note buttons as needed so they fit in the correct area on the main screen.

The Note Entry fields are not available in Chromatic mode.

Exit

In the Tuner Programming screen, click the Exit button to return to the main InTune screen.

Using InTune

When InTune detects a signal, the meter lights up and displays the relative pitch of the incoming signal. With stringed instruments, this will vary during the attack and decay of the note.

In Automatic mode, InTune estimates the note to which you are trying to tune. If the correct note is not lit in automatic mode, click on the note to which you are trying to tune for greater accuracy. This will lock InTune to the specified note.

The meter will display the frequency of the note detected, and the accuracy is displayed on a scale of plus/minus 50 cents. In addition, the information display will display the note and the number of cents from perfect tuning.

When loading factory presets, stringed instruments are laid out from the highest numbered string (usually the lowest tone) to the highest, from left to right. For example, a six string guitar in standard tuning is shown as E2, A2, D3, G3, B3, E4, which are the notes and octaves for the sixth string through to the first string respectively.

For best tuning results with guitars, do the following:

- Use headphones, as loud monitors can modulate the guitar string.
- Switch your guitar to its rhythm (neck) pickup, if it has one.
- Roll your guitar's tone knobs all the way off to remove all the highs.
- Pluck the open string right over the twelfth fret, not over the pickup.

To produce convenient test tones, select the appropriate preset from the Librarian menu and select an appropriate test tone from the Test Tone menu. Click a Note button to produce the appropriate test tone. Test tones can be routed to headphones as required for musicians during session.

Chapter 58: MasterMeter

MasterMeter is an oversampling meter plug-in that is designed for critical mixing and mastering applications. MasterMeter is available in DSP and Native formats.

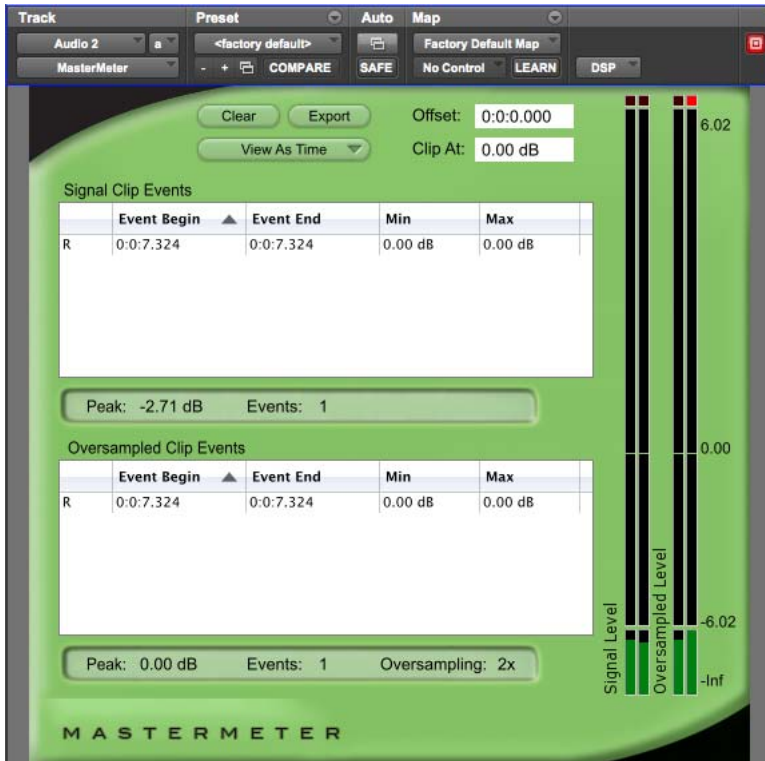

MasterMeter

MasterMeter Overview

This section provides an overview of metering and mastering, and how MasterMeter can help you produce great sounding mixes.

Understanding Digital Distortion

Clients in the music industry regularly demand the loudest possible mixes. In the process of achieving such a “hot mix,” unwanted distortion can be introduced. Intersample peaks that exceed 0 dB may play without distortion in a studio environment, but when the same mix is played through a consumer CD player, the digital to analog conversion and oversampling process can reproduce a distorted mix.

Digital Audio Theory

A key observation in digital audio theory is that the entire waveform is represented by the sampling points, but a reconstruction process still needs to occur in order to recreate the waveform represented. One cannot simply “connect the dots” between sample points and yield the original waveform.

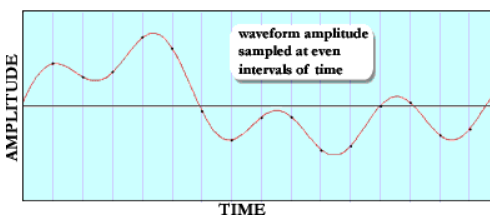

Sampling

A waveform can be represented in multiple ways during the process of sampling, display and reconstruction.

The following four figures show how the same complex waveform shown in the previous figure can be represented in the digital domain.

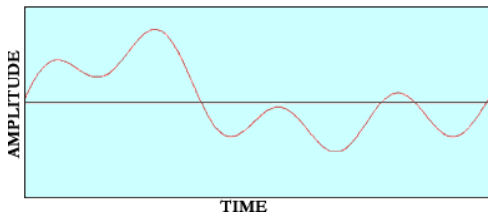

A complex waveform

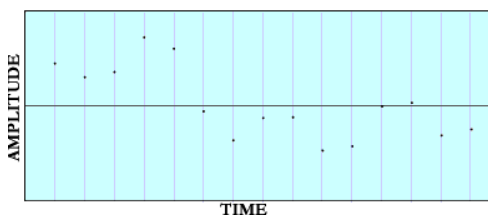

Waveform sampled

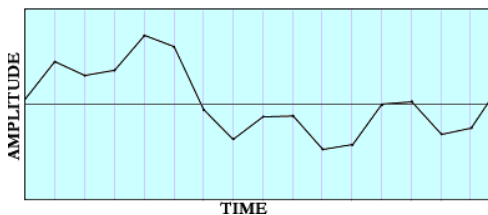

Waveform as represented in DAW

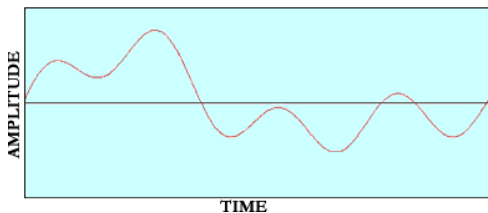

Waveform as reconstructed at the D/A

The process of recreating the original waveform from the sampled waveform involves a filter called a reconstruction filter. This filter removes all content above the Nyquist frequency (half the sample

rate). The range below the Nyquist frequency defines the “legal” range of allowed frequencies as frequencies in this range can be accurately reproduced. All frequencies above the Nyquist frequency do not adhere to Nyquist or Shannon’s theorems regarding allowable frequencies, cannot be reproduced and are therefore considered “illegal” frequencies. Because of mathematical realities observed by Fourier in the 1800s and subsequently by Shannon in 1948, when a waveform has all frequencies removed above the Nyquist frequency, the resulting waveform will be the original waveform that was sampled.

This process is significantly more involved than simply “connecting the dots” between sample points. Today it involves extremely sophisticated means of reconstructing the waveform, using filters that are highly complex mathematical systems utilizing “oversampling,” “upsampling,” “linear phase, equiripple FIR” designs and much more.

Oversampling creates a more accurate digital representation of an analog signal by sampling some number of times per second (frequency) and converting into digital form. Oversampling requires at least twice the bandwidth of the frequency being sampled. For example, a consumer CD player using 2x oversampling is processing information at 88.2 kHz.

The result is that today’s digital to analog converters get closer to the original than ever before, making music played on systems today as accurate as possible. Even today’s inexpensive components such as off-the-shelf CD players have drastically improved filters and thus better reconstruction abilities than in years past.

Application

Most contemporary audio recording is done with Digital Audio Workstations (DAWs), although digital mixing systems in the form of outboard digital mixers are also very popular. To the user, these digital systems appear similar to traditional audio tools and are designed order to emulate the operation of a conventional analog recording system.

One familiar analog tool that has been carried over to the digital realm is a “peak meter” that tells the amplitude of the waveform’s peaks. In the analog realm, peak signal was an indicator that would alert the audio engineer when the peak signal level was getting too high. A peak signal in analog recording would cause the tape to saturate, creating distortion. In an analog system however, this type of distortion was often deliberately engineered into tracks in order to achieve a certain sound.

In the digital realm this type of meter is important and more vital, because if the amplitude of a waveform exceeds the top of the measurable scale (full scale, or “full code”), the signal will “clip” causing unwanted and unpleasant distortion rather than the traditional distorted sound of analog. This digital clipping occurs because the waveform is “lopped off” and the data is changed. When the waveform is reconstructed it cannot be accurately done in order to represent the original waveform. Instead, it has a significant amount of inharmonic distortion caused by aliasing. For this reason, digital recording has a maximum level at which signals can be recorded. Anything exceeding this level (full scale) has undesirable consequences.

The method used for computing the peak value inside the system however is not particularly accurate. DAW systems typically take the amplitude of the samples and use these as the basis for the peak meter. The problem with this approach is easily identified: the samples themselves do not represent the peak value of the waveform. The waveform is only complete after the reconstruction process. Un-

til this process has been completed, the waveform is inaccurately represented by the samples. This is the reason that in most DAWs the waveform is represented on the screen as a “dot to dot” connection between sample points. They do not undergo the reconstruction process inside the system, so all that can be represented is the sample points and for the sake of visual ease, they connect the dots between them with straight lines. They save the reconstruction process for the digital to analog converters.

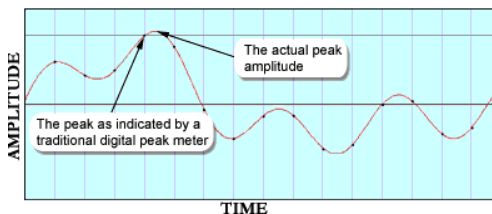

Intersample peaks

The consequence of the way in which DAWs treat waveforms is that the meter inside the DAW or other digital mixers inevitably shows inaccurate information. It is virtually a mathematical certainty that the waveform will exceed the amplitude of the samples in any sampling system. The samples themselves only represent a waveform. It is important to understand that the amplitude of the waveform will invariably exceed the sample values.

Manifestation

Today’s recording environment demands that sessions are mixed and mastered as “hot” as is possible, pushing the levels up to the highest tolerable amount, supposedly just short of clipping. Sophisticated digital tools allow music to be highly compressed, then recompressed, compressed even more so with multi-band compressors, limited, normalized, and maximized to get the audio to play as loud as possible out of a consumer’s system. Hence, it is very common for popular music CDs to be full of digital samples that are at, or nearly at full scale.

The problem is realized in that while going through these digital gyrations and utilizing digital tools to amplify the signal as much as possible, both during mixing and during mastering, the “peak value” of the sample points is closely watched to ensure that it does not get to full scale. Since the peak meters in said DAW and digital mixing systems are inaccurate, and do not actually indicate the peak values of the resulting waveform, the result is that while the samples themselves do not exceed full scale and are carefully monitored to ensure this, the resulting waveforms represented by the samples may exceed full scale throughout any standard CD!

While the digital mixing system is not clipping the music or distorting the music, the digital to analog converters that have the task of recreating the audio through digital reconstruction filters are clipping repeatedly throughout most CDs on the market. The result is that most CDs and DVDs end up distorting with regularity when they are asked to reconstruct and play back audio that appears to be completely “legal” because not a single sample actually clipped.

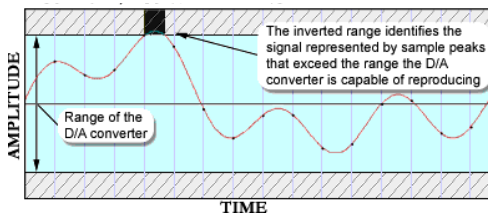

D/A converter range

Seven consumer CD players were subjected to tests [Nielsen 2003] designed to analyze their ability to reproduce and reconstruct signal levels above full scale (0 dBFS). All of the players experienced difficulty dealing with signal levels this high, further showing that, while all of the samples can be legal, the level can still be hotter than is legal. The result is that a CD player can be unable to reproduce the audio accurately. In some cases, the reconstruction sounds “perfect” to the mastering engineer, because the engineer’s equipment can actually reproduce the waveforms properly.

The Red Book format for CDs and the DVD specs both allow for this illegal content and the mastering engineer is still allowed to put out releases that meet the spec while allowing consumers’ players to distort. With an oversampled peak meter, the engineer will be able to know that the music is clipping, by how much and where. With this knowledge the engineer can then decide with complete information whether or not to accommodate the legal range of digital audio on a PCM sampled system.

The goal of MasterMeter is to allow an engineer to use a DSP model of the reconstruction process to monitor the reconstructed waveform for potential clipping at the final mix and mastering stages. Using MasterMeter, engineers can compare regular and intersample peaks over time and make appropriate adjustments without sacrificing overall level or dynamic range. Utilizing an oversampled peak meter in the digital audio studio that represents the reconstruction filters in digital to analog converters is the first step toward an improvement in audio quality in music releases.

Using MasterMeter

MasterMeter uses the DSP power of Pro Tools to model the conversion process found in typical consumer devices. In technical terms, the MasterMeter algorithm uses a 31-tap Blackman-Harris windowed sinc conversion with oversampling ratios from 2x to 8x depending on the session sample rate. The output of this DSP algorithm is then displayed visually. This assists engineers in highlighting potential distortion which may be introduced on playback of mixes, especially mixes which have been processed to be particularly loud or “hot.”

MasterMeter can be used in two different ways during a session: Real-Time Metering or Historical Metering.

Real-Time Metering

MasterMeter can be used to monitor live signal levels, even if the Pro Tools transport is stopped. This can be useful in quickly determining the appropriate level for mixing and mastering.

When used in real time, the timecode information displayed in the browsers should be ignored.

Historical Metering

To gain an overall picture of the levels in an entire session, MasterMeter can be inserted on a Master Fader track and the entire session played from beginning to end. This is typically done during final mix and mastering.

When session playback is complete, MasterMeter shows historical peak and event information for the entire session, as well as a historical list of events in the browsers for both signal clips and oversampled clips. You can then manually examine the relevant parts of the session using the timecode listed in the browsers to determine any appropriate corrective actions.

MasterMeter Controls and Displays

MasterMeter Browsers

Signal Clip Events Browser

	Event Begin	Δ	Event End	Min	Max
L	0:0:1.247		0:0:1.247	0.00 db	0.00 db
L	0:0:1.247		0:0:1.247	0.00 db	0.00 db
R	0:0:2.317		0:0:2.317	0.00 db	0.00 db
R	0:0:2.317		0:0:2.317	0.00 db	0.00 db
L	0:0:2.318		0:0:2.318	0.00 db	0.00 db
L	0:0:2.320		0:0:2.320	0.00 db	0.00 db
R	0:0:2.322		0:0:2.322	0.00 db	0.00 db

Peak: 0.00 db Events: 592

Signal Clip Events browser

The Signal Clip Events browser displays historical clip events from the current session. The columns displayed show the relevant timecode for the beginning and ending of a clip event. When used in a stereo track, the first column shows L or R to indicate if the left or right channel has clipped. The Min and Max values in this browser will always be zero, unless the Clip level is set below zero. The contents of this browser can be sorted in ascending and descending order by any column simply by clicking on a column one or more times.

The time information displayed in this browser is relative to where the transport started. The Offset field can be used to adjust the timecode values if MasterMeter is being used for historical metering but the session was started from a point other than the beginning. If MasterMeter is being used in real time, the timecode information in this browser can be ignored.

At the bottom of the browser, the Peak field displays the highest dB value of the audio signal received so far. The Events field shows the historical total of clip events in the audio signal. Once MasterMeter reaches 2,000 clip events, it ceases to record additional events. Although the meters remain

active and the Peak field continues to be updated, new events will not be added to the browsers. The Events field flashes “2000” to indicate this condition.

The information in this browser is cleared using the Clear button, or is cleared automatically whenever the Pro Tools transport is started.

Oversampled Clip Events Browser

	Event Begin	Δ	Event End	Min	Max
L	0:0:1.247		0:0:1.247	0.01 db	0.01 db
L	0:0:1.247		0:0:1.247	0.00 db	0.00 db
L	0:0:1.247		0:0:1.247	0.00 db	0.02 db
L	0:0:1.247		0:0:1.247	0.00 db	0.05 db
L	0:0:1.247		0:0:1.247	0.00 db	0.04 db
R	0:0:2.317		0:0:2.317	0.01 db	0.03 db
R	0:0:2.317		0:0:2.317	0.00 db	0.00 db

Peak: 0.83 db Events: 1666 Oversampling: 8X

Oversampled Clip Events browser

The Oversampled Clip Events browser displays historical clip events from the DSP oversampling of the session audio. The amount of potential clipping in excess of 0 dB is also displayed.

The columns displayed show the relevant timecode for the beginning and ending of a clip event, as well as the minimum and maximum clip values created after passing through the DSP processing. When used in a stereo track, the first column shows L or R to indicate if the left or right channel has clipped. The contents of this browser can be sorted in ascending and descending order by any column simply by clicking on a column one or more times.

The time information displayed in this browser is relative to where the transport started. The Offset field can be used to adjust the timecode values if MasterMeter is being used for historical metering but the session was started from a point other than the beginning. If MasterMeter is being used in real time, the timecode information in this column can be ignored.

At the bottom of the browser, the Peak field displays the highest dB value of the oversampled audio received so far. The Events field shows the historical total of clip events in the oversampled audio signal. Once MasterMeter reaches 2000 clip events, it ceases to record additional events. Although the meters remain active and the Peak field continues to be updated, new events will not be added to the browsers. The Events field flashes '2000' to indicate this condition.

The Oversampling field displays the current oversampling factor in use by the DSP processing. This will vary between 2x, 4x and 8x oversampling depending on the session sample rate.

The information in this browser is cleared using the Clear button, or is cleared automatically whenever the Pro Tools transport is started.

MasterMeter Meters

Signal Level Meters

The Signal Level meter shows the instantaneous signal level of the current audio signal. The clip light at the top of the meter can be cleared by clicking on it, or by using the Clear button.

Oversampled Level Meter

The Oversampled Level meter shows the instantaneous signal level of the current audio signal after it has been oversampled. As the oversampling process can create levels above 0 dB, this meter shows an expanded scale from -6 dB to 0 dB and from 0 dB to +6 dB.

The clip light at the top of the meter can be cleared by clicking on it, or using the Clear button.

MasterMeter Clear Button

The Clear button clears all of the historical information displayed in Signal Clip Events browser and the Oversampled Clip Events browser. It also click the clip lights at the top of the Signal Level and Oversampled Level meters. This information is also cleared when the Pro Tools transport is activated by pressing Play or Record.

MasterMeter Export Button

The Export button exports all of the information displayed in the two browsers to the clipboard as tab delimited text. It can then be pasted into any text or spreadsheet application.

MasterMeter View Time Menu

The View Time menu lets you select the way in which timing information is displayed, in either minutes and seconds format, or in samples format. This affects the timecode display in both the data browsers and the Offset field.

MasterMeter Offset Field

The Offset field offsets the values displayed in both the browsers by the value entered. This is useful for historical metering but the session was started from a point other than the beginning. The Enter key must be used after a new offset is typed for it to become active. The information shown in the browsers is updated immediately when the new Offset is entered.

For example, if the session was started from the point 1:03.901 (1 minute 3.901 seconds), this value should be entered into the Offset to ensure the time-code displayed in both of the browsers matches that of the Pro Tools session.

MasterMeter Clip Field

The Clip field can be used to set the clip threshold at a lower point. For example, if a session must not exceed -10 dB, the Clip field can be set to -10 dB and MasterMeter will treat that as the clip threshold for both signal and oversampled clip events. When the Clip field is set to a non-zero value, the Min and Max values of the Signal Clip browser are used to indicate the clip range.

Chapter 59: Signal Generator

The Signal Generator plug-in produces audio test tones in a variety of frequencies, waveforms, and amplitudes. It is particularly useful for generating reference signals with which to calibrate audio interfaces and other elements of your studio.

Signal Generator is a mono (or multi-mono) plug-in that is available in DSP, Native, and AudioSuite formats.

Signal Generator supports 44.1 kHz, 48 kHz, 88.2 kHz, 96 kHz, 176.4 kHz and 192 kHz sample rates.



Signal Generator

 Refer to the guide for your audio interface for instructions on using Signal Generator to calibrate that interface.

 Signal Generator produces a tone as soon as it is inserted on a track. To mute the Signal Generator, use the Bypass button.

Signal Generator Controls

The Signal Generator plug-in provides the following controls:

Frequency Sets the frequency of the signal in hertz. Values range from a low of 20 Hz to a high of 20 kHz in a 44.1 kHz session. The upper limit of the frequency range for this setting will increase to match the *Nyquist frequency* (half the sample rate) in 96 kHz and 192 kHz sessions (HD-series systems only).

Level Sets the amplitude of the signal in decibels. Values range from a low of -95 dB to a high of 0.0 dB.

Signal These buttons select the waveform. Choices are sine, square, sawtooth, triangle, white noise, and pink noise.

 *The Signal Generator plug-in is not intended for rigorous test purposes; it is a simple level calibration tool.*

Peak Generates signal at the maximum possible level without clipping.

RMS Generates signal at levels consistent with the RMS (Root-Mean-Square) value, or the effective average level of the signal.

AudioSuite Processing with Signal Generator

To create an audio clip using the Signal Generator plug-in:

- 1 Make a selection in the Edit window.
- 2 Choose AudioSuite > Signal Generator.
- 3 Enter values for the Frequency, Level, and Signal controls.
- 4 Click Render in the Signal Generator plug-in.

 *Select the Create Continuous File option for greater flexibility in making audio selections for use with the Signal Generator plug-in.*

 *You can use the AudioSuite Signal Generator plug-in for musical purposes as well as for testing purposes. For example, you might want to add a little color to a kick drum track by doubling it with a 50 Hz tone, using the kick track as the key input signal gating the tone track.*

Chapter 60: SoundReplacer

SoundReplacer is an AudioSuite only plug-in designed to replace audio elements such as drums, percussion, and sound effects in Pro Tools tracks with alternate sounds. SoundReplacer can quickly and intelligently match the timing and dynamics of original performance material, making it ideal for both music and audio post production.

SoundReplacer features:

- Sound replacement with phase-accurate peak alignment
- Intelligent tracking of source audio dynamics for matching the feel of the original performance
- Three separate amplitude zones per audio event for triggering different replacement samples according to performance dynamics
- Zoomable waveform display for precision threshold/amplitude zone adjustment
- Crossfading or hard-switching of replacement audio in different amplitude zones for optimum realism and flexibility
- Online help



SoundReplacer

Audio Replacement Techniques

Replacing audio elements during the course of a recording session is a fairly common scenario. In music production it is often done in order to replace or augment an element that lacks punch. In film or video post-production it is typically done to improve or vary a specific sound cue or effect.

In the past, engineers and producers had to rely on sampling audio delay lines or MIDI triggered audio samplers—methods that had distinct disadvantages. Delay lines, for example, support only a single replacement sample, and while they can track the amplitude of the source events, the replacement sample itself remains the same at different amplitude levels.

The result is static and unnatural. In addition to these drawbacks, sample triggers are notoriously difficult to set up for accurate timing.

Similarly, with MIDI triggered samplers, MIDI timing and event triggering are inconsistent, resulting in problems with phase and frequency response when the original audio is mixed with the triggered replacement sounds.

The SoundReplacer Solution

SoundReplacer solves these timing problems by matching the original timing and dynamics of the source audio while providing three separate amplitude zones per audio event. This lets you trigger different replacement samples according to performance dynamics.

Each replacement sample is assigned its own adjustable amplitude zone. Variations in amplitude within the performance determine which sample is triggered at a specific time. For example, you could assign a soft snare hit to a low trigger threshold, a standard snare to a medium trigger threshold, and a rim shot snare to trigger only at the highest trigger threshold.

Replacement samples that are triggered in rapid succession or in close proximity to each other will overlap naturally—avoiding the abrupt sound truncation that occurs on many samplers.

In addition to its usefulness in music projects, SoundReplacer is also an extremely powerful tool for sound design and post production. Morphing gun shots, changing door slams, or adding a Doppler effect can now be accomplished in seconds rather than minutes—with sample-level precision.

Replacement audio events can be written to a new audio track, or mixed and re-written to the source audio track. Sample thresholds can be amplitude-switched between the replacement samples, or amplitude crossfaded for seamless transitions.

SoundReplacer Controls

SoundReplacer Waveform Display

The waveform display shows the audio that you have selected for replacement. When you select audio on the source track, then open SoundReplacer, the audio waveform will automatically be displayed here.

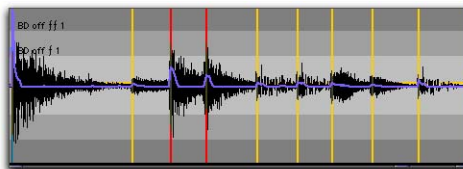

Waveform display with trigger markers shown

Once the audio selection is displayed, you can load replacement samples and adjust their trigger thresholds while viewing the waveform peaks. Trigger markers then appear in the waveform, indicating the points at which the samples will be triggered.

The color of each marker indicates which threshold/replacement sample will be triggered. The blue Trigger Envelope shows the waveform slope that determines the trigger points. The Zoomer lets you increase or decrease waveform magnification here to help accurately set trigger thresholds.

If you change the audio selection on the source track, SoundReplacer automatically updates the waveform display each time you make a new selection or begin playback.

SoundReplacerTrigger Threshold



Threshold controls

The color-coded Trigger Threshold sliders set a total of three amplitude zones (one for each replacement audio file) for triggering replacement samples:

- The yellow slider represents amplitude zone 1, the lowest-level trigger.
- The red slider represents amplitude zone 2, the middle-level trigger.
- The blue slider represents amplitude zone 3, the highest-level trigger.

With a replacement sample loaded, drag the Threshold slider to set the amplitude level. Color-coded trigger markers will appear in the Waveform at points where the source audio signal exceeds the threshold set for that amplitude zone. The replacement sample will be triggered at these points.

The color of the Trigger markers correspond to the matching Threshold slider. This lets you see at a glance which replacement samples will be triggered and where they will be triggered.

 *If you zoom the waveform display below a specific Trigger Threshold slider's amplitude zone, the slider will be temporarily unavailable. To access the slider again, zoom back out to an appropriate magnification level.*

SoundReplacer Load/Unload Sound Buttons



Load/Unload Sound

Clicking the Load/Unload Sound icons loads or unloads replacement samples for each of the three trigger threshold amplitude zones. Clicking the Floppy Disk icon loads a new sample (or replaces the current sample). Clicking the Trash Can icon unloads the current sample.

 *SoundReplacer lets you choose whether or not to use sample rate conversion before loading replacement samples if they are at a different sample rate from the session.*

To audition a replacement sample before loading it into SoundReplacer, use the Import Audio command in Pro Tools. Once you have located and previewed an audio file, you can then load it into SoundReplacer using the Load/Unload Sound icons.

 *SoundReplacer does not load clips that are part of larger audio files. To use a clip as a replacement sample, you must first save it as an individual audio file.*

SoundReplacer Zoomer



Zoomer

The Zoomer increases or decreases magnification of the waveform data currently visible in the center of the waveform display so that you can more accurately set sample trigger thresholds.

- To zoom in on amplitude, click the Up Arrow.
- To zoom out on amplitude, click the Down Arrow.
- To zoom in on time, click the Right Arrow.
- To zoom out on time, click the Left Arrow.

⚠ *If you zoom the waveform display below a specific Threshold slider's amplitude zone, the slider will be temporarily unavailable. To access the slider again, zoom back out to an appropriate magnification level.*

SoundReplacer Crossfade

When Crossfade is selected, SoundReplacer crossfades between replacement audio files in different amplitude zones. This helps smooth the transition between them.

When Crossfade is deselected, SoundReplacer hard switches between replacement audio files in different amplitude zones.

Crossfading is particularly useful for adding a sense of realism to drum replacement. Crossfading between a straight snare hit and a rim shot, for example, results in a much more “live” feel than simply hard switching between the two samples.

SoundReplacer Peak Align

When Peak Align is on, SoundReplacer aligns the peak of the replacement file with the peak of the source file in a way that best maintains phase coherency. When Peak Align is off, SoundReplacer aligns the beginning of the replacement file with the trigger threshold point.

Depending on the characteristics of your source and replacement audio files, using Peak Align can significantly affect the timing of audio events in the replacement file. It is essential that you choose the option most appropriate to the material that you are replacing.

 *For more information on using Peak Align, see “Getting Optimum Results with SoundReplacer” on page 362.*

SoundReplacer Mix

Mix adjusts the mix of the replacement audio file with the original source file. Higher percentage values weight the mix toward the replacement audio. Lower percentage values weight the mix toward the original source audio.

The Mix button toggles the Mix control on and off. When Mix is toggled off, the balance is instantly set to 100% replacement audio.

 *Setting Mix to 50% and clicking Preview lets you audition source audio and replacement audio together to check the accuracy of replacement triggering timing.*

SoundReplacer Dynamics

Dynamics controls how closely the audio events in the replacement file track the dynamics of the source file:

- ◆ Setting the ratio to 1.00 matches the dynamics of the source file.
- ◆ Increasing the ratio above 1.00 expands the dynamic range so that softer hits are softer, and louder hits are louder. This is useful if the source material lacks variation in its dynamic range.
- ◆ Decreasing the ratio below 1.00 compresses the dynamic range so that there is less variation between loud and soft hits. This is useful if the dynamics of the source material are too extreme.

The Dynamics button provides a quick means of toggling on and off the Dynamics control. When Dynamics is toggled off, SoundReplacer will not track changes in the source audio file's dynamics. Audio events in the resulting replacement audio file will uniformly be at the amplitude of the replacement samples themselves, with no variation in dynamics.

SoundReplacer Online Help

To use online help, hold the pointer over any control and an explanation will appear.

Using SoundReplacer

Following are basic guidelines for using SoundReplacer effectively. Also see “Getting Optimum Results with SoundReplacer” on page 362.

To use SoundReplacer:

- 1 On the source track, select the audio you want to replace. Only selected audio will be replaced.
 - 2 Choose SoundReplacer from the AudioSuite menu.
 - 3 Click the Load Sound icon (the icon beneath the yellow slider) to import the replacement sound for amplitude zone 1.
 - 4 Locate an audio file and click Open.
 - 5 Adjust the amplitude zone slider.
 - 6 Repeat steps 3–5 to load replacement sounds into amplitude zones 2 and 3.
-  *If you use only a single replacement sample, you should still set all three amplitude zones for optimum results. This will ensure accurate triggering. For details, See “Mapping The Same Sample Into Multiple Amplitude Zones with SoundReplacer” on page 363.*
- 7 To align the amplitude peak in the replacement file(s) to threshold trigger markers in the source audio, enable Peak Align.
 - 8 Click Preview to audition the replacement audio.
 - 9 Adjust the Threshold sliders to fine tune audio replacement triggering.
 - 10 Adjust the Dynamics slider to fine tune how SoundReplacer tracks and matches changes in the source audio's dynamics.
 - 11 Adjust the Mix slider to set the balance between replacement audio and source audio.
 - 12 Adjust the AudioSuite File controls. These settings will determine how the file is rendered and what effect the rendering will have on the original clips.
 - 13 Render the selected clip by doing one of the following:
 - To render the selected clip only in the track in which it appears, choose Playlist from the Selection Reference pop-up.
 - To render the selected clip in the Audio Clip List only, choose Clip List from the Selection Reference pop-up.

- 14 Determine which occurrences of the selected clip you want to render by doing one of the following:
 - To render and update every occurrence of the selected clip throughout your session, enable **Use In Playlist** (and also choose **Clip List** from the **Selection Reference** pop-up).
 - If you do not want to update every occurrence of the selected clip, disable **Use In Playlist**.
 - 15 If you have selected multiple clips for rendering and want to create a new file that connects and consolidates all of these clips together, choose **Create Continuous File** from the **File mode** pop-up menu.
-  *Because SoundReplacer does not allow destructive rendering, the AudioSuite **Overwrite Files** option is not available.*
- 16 From the **Destination Track** pop-up, choose the destination for the replacement audio.
 - 17 Click **Render**.

Getting Optimum Results with SoundReplacer

Getting optimum results with SoundReplacer generally means making sure that the audio events in the replacement audio file have accurate timing in relation to the source audio. The techniques given here help ensure this.

Using Peak Align in SoundReplacer

Proper use of the **Peak Align** feature can significantly improve the results of sound replacement. Since turning **Peak Align** on or off controls how SoundReplacer aligns the replacement audio with the source audio, it will significantly affect the timing of audio events in the replacement file.

In general:

- ◆ Turn on **Peak Align** if you are replacing drum or percussion sounds whose peak level occurs at the initial attack.
- ◆ Turn off **Peak Align** if you are replacing sounds whose peak level occurs somewhere *after* the initial attack. **Peak Align** should also be turned off if the sounds you are replacing are *not* drum or percussion sounds.

To illustrate why Peak Align makes a difference, look at the following two illustrations.

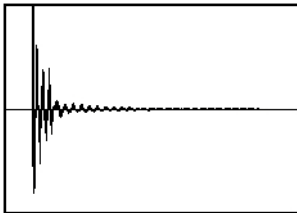

A fast-peaking kick drum

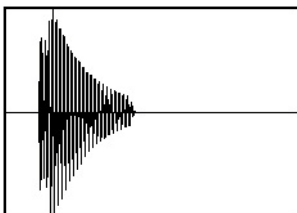

A slower-peaking kick drum

The first figure shows a fast-peaking kick drum whose peak level occurs at its initial attack.

The second figure shows a slower-peaking kick drum whose peak level occurs *after* its initial attack.

If you turn on Peak Align and attempt to replace the fast-peaking kick with the slow-peaking kick (or vice-versa), SoundReplacer will align their peaks—which occur at different points in the sound. The audible result would be that the replacement audio file (slow-peaking kick) would trigger too early.

Mapping The Same Sample Into Multiple Amplitude Zones with SoundReplacer

If you are performing drum replacement and intend to use just a single replacement sample, mapping it into multiple amplitude zones will ensure more accurate triggering. Here is why:

Imagine that you are replacing a kick drum part. If you look at the waveform of a kick drum, you will often see a “pre-hit” portion of the sound that occurs as soon as the ball of the kick pedal hits the drum. This is rapidly followed by the denser attack portion of the sound, where most of sound’s weight is.

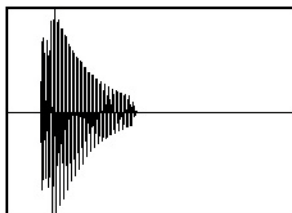

A kick drum with a pre-hit preceding a denser attack

With a sound like this, using a single amplitude threshold presents a problem because typically, in pop music, kick drum parts consist of loud accent hits and softer off-beat hits that are often 6 dB or more lower in level.

If you use a single amplitude threshold to trigger the replacement sample, you have to set the threshold low enough to trigger at the soft hits. The problem occurs at the loud hits: The threshold is now set so low that the pre-hit portion of the loud hits can exceed the threshold—triggering the replacement sample too early. This results in a replacement track with faulty timing.

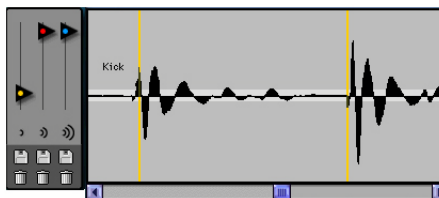

A single low threshold causes the second, louder kick to trigger too early, as evidenced by the trigger marker at the very start of the waveform.

The best way to avoid this problem is to set multiple threshold zones for the same sample using a higher threshold for the louder hit. Soft hits will trigger threshold 1 and louder hits will trigger threshold 2.

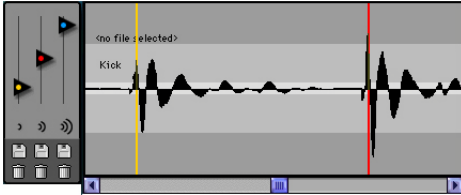

Using a second, higher threshold for the louder kick will make it trigger properly, as shown by the now properly-aligned trigger marker.

To set the precise threshold for louder hits, you may need to zoom in carefully to examine the waveform for trigger points (indicated by color-coded trigger markers) and then Command-drag the Threshold slider for more precise adjustment.

If there is a great deal of variation in the dynamics of the source audio, you may need to use all three Trigger Thresholds/Amplitude Zones for optimum results.

 *If only one replacement sample is loaded into SoundReplacer and it is loaded into Trigger threshold/amplitude zone 1 (yellow), SoundReplacer will let you use the red and blue Trigger Threshold sliders to set Amplitude Zones 2 and 3—without having to load the same sample again.*

Using the Audio Files Folder for Frequently Used SoundReplacer Files

If you often use the same settings and replacement sounds in different sessions, SoundReplacer provides a convenient way to keep the replacement audio files and settings linked together.

When you choose a preset from the Plug-In Librarian menu, SoundReplacer looks for the replacement audio files associated with that preset. SoundReplacer first looks in the audio file's original hard disk location (at the time you saved the setting).

If it is not there, SoundReplacer looks in a folder named Audio Files within SoundReplacer's Root Plug-In Settings folder (Plug-In Settings/SoundReplacer/Audio Files).

If SoundReplacer finds the replacement audio file there, the Settings file will load with the associated audio.

By always putting replacement audio files in this special folder, you can freely exchange SoundReplacer settings—and the audio files associated with them—with other users.

 *Do not create subfolders within SoundReplacer's Audio Files folder. Files located within subfolders are not recognized.*

Chapter 61: Time Compression/Expansion

Time Compression/Expansion is an AudioSuite-only time-processing plug-in. The Time Compression/Expansion plug-in adjusts the duration of selected clips, increasing or decreasing their length without changing pitch.

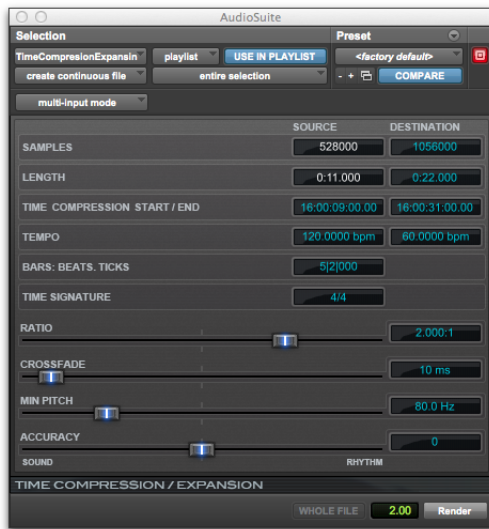

Time Compression/Expansion plug-in

It is especially useful in audio post production for adjusting audio to specific time or SMPTE durations for synchronization purposes. Time Compression/Expansion is nondestructive.

💡 *Normalizing a selection before using Time Compressing/Expansion may produce better results.*

Time Compression/Expansion Controls

The Time Compression/Expansion plug-in provides the following controls:

Source and Destination The Source fields display the length of the current selection before processing in each of the listed formats. All fields are always active; a change made to one value is immediately reflected in the others.

The Destination fields both display and control the final length of the selection after processing. Enter the length of the Destination file by double-clicking the appropriate field in the Destination column.

Use the Ratio, Crossfade, Min Pitch, and Accuracy controls to fine-tune the Time Compression/Expansion process.

Ratio Sets the destination length in relation to the source length. Moving the slider to the right increases the length of the destination file, while moving the slider to the left decreases its length.

Crossfade Adjusts the crossfade length in milliseconds, optimizing performance of the Time Compression/Expansion according to the type of audio material being processed. (This plug-in achieves length modification by replicating or subtracting very small portions of audio material and very quickly crossfading between these alterations in the waveform of the audio material.)

Crossfade length affects the amount of smoothing performed on audio material. This prevents audio artifacts such as clicks from occurring. Long crossfade times may over-smooth a signal and its transients. This may not be desirable on drums and other material with sharp transients.

Use the Crossfade slider to manually adjust and optimize crossfade times if necessary. For audio material with sharper attack transients, use smaller crossfade times. For audio material with softer attack transients, use longer crossfade times.

Min Pitch Sets the minimum, or lowest, pitch that will be used in the plug-in's calculations during the Time Compression/Expansion process. The control has a range of 40 Hz to 1000 Hz.

This control should be set lower when processing bass guitar or audio material with a low frequency range. Set this control higher when processing higher frequency range audio material.

Accuracy Prioritizes the processing resources allocated to audio quality (Sound) or timing (Rhythm). Moving the slider towards "Sound" generally results in better sonic quality and fewer audio artifacts. Moving the slider towards "Rhythm" puts the emphasis on keeping the tempo consistent.

When you are working with audio loops, listen carefully and adjust the Accuracy slider until you find a setting that keeps timing solid within the clip. If you don't, start and end times may be precise, but the beats in rhythmic material may appear to be shuffled if too little priority is given to Rhythm.

Chapter 62: Trim

Trim is a mono (or multi-mono) plug-in that is available in DSP and Native formats.

Trim supports 44.1 kHz, 48 kHz, 88.2 kHz, 96 kHz, 176.4 kHz and 192 kHz sample rates.

Use Trim to attenuate an audio signal from $-\infty$ (Infinity) dB to +6 dB or $-\infty$ (Infinity) dB to +12 dB. For example, using a multi-mono Trim plug-in on a multi-channel track provides simple, DSP-efficient muting control over the individual channels of the track.

This capability is useful, since Track Mute buttons mute *all* channels of a multi-channel track and do not allow muting of individual channels within the track.



Trim

 *Alt-click (Windows) or Option-click (Mac) the Trim selector to open a plug-in window for each channel of a multi-channel track.*

Trim Controls

The Trim plug-in provides the following controls:

Phase Invert Inverts the phase (polarity) of the input signal to change the frequency response characteristics between multi-miked sources or to correct for miswired microphone cables.

Gain Provides $-\infty$ dB to +6 dB or +12 dB of gain adjustment, depending whether the Gain toggle is set to +6 or +12.

+6/+12 Gain Toggle Switches the maximum level of attenuation between $-\infty$ dB to +6 dB and $-\infty$ dB to +12 dB.

 *Automation data adjusts to reflect the current Gain setting. When working with automation data from an older version of the Trim plug-in, ensure the Gain setting is set at +6 dB.*

Output Meter Indicates the output level, including any gain compensation added using the Gain control.

Mute Mutes the signal output.

Chapter 63: Other AudioSuite Plug-In Utilities

The following AudioSuite-only utility plug-ins are installed when you install Pro Tools:

- DC Offset Removal
- Duplicate
- Gain
- Invert
- Normalize
- Reverse

DC Offset Removal

The DC Offset Removal plug-in removes DC offset from audio files. DC offset is a type of audio artifact (typically caused by miscalibrated analog-to-digital converters) that can cause pops and clicks in edited material.

To check for DC offset, find a silent section in the audio material. If DC offset is present, a near-vertical fade-in with a constant or steady-state offset from zero will appear in the waveform. Use the DC Offset Removal plug-in to remove it.



DC Offset Removal

To remove DC offset from an audio clip:

- 1 Select the clip with DC offset.
- 2 Choose AudioSuite > Other > DC Offset Removal.
- 3 Ensure that Use In Playlist is enabled.
- 4 Click Render.

Duplicate

The Duplicate plug-in duplicates the selected audio in place. Depending on how its controls are configured, the new clip will appear in either the Clip List or playlist. You can use this to flatten or consolidate an entire track consisting of multiple clips into one continuous audio file that resides in the same place as the original individual clips.



Duplicate

The audio is unaffected by Pro Tools volume or pan automation, or by any real-time plug-ins that may be in use on the track as inserts. The original audio file clips are merely rewritten in place to a single duplicate file.

The Duplicate plug-in works nondestructively. You cannot choose to overwrite files.

To duplicate an audio selection:

- 1 Select the audio you want to duplicate.
- 2 Choose AudioSuite > Other > Duplicate.
- 3 Ensure that Use In Playlist is enabled.
- 4 Click Render.

Gain

The Gain plug-in boosts or lowers a selected clip's amplitude by a specific amount. Use it to smooth out undesired peaks and other dynamic inconsistencies in audio material.



Gain

Gain Specifies the gain amount. Set this value by manually adjusting the Gain slider, by entering a numeric decibel value, or by entering a percentage.

Analyze When clicked, displays the peak amplitude value of the current selection.

RMS/Peak Toggle Switches the calibration of gain adjustment between Peak or RMS modes. Peak mode adjusts the gain of the input signal to the maximum possible level without clipping. RMS mode adjusts the input signal to a level consistent with the RMS (Root-Mean-Square) value, or the effective average level of the selected clip.

To change the gain of an audio clip:

- 1 Select the clip whose gain you want to change.
- 2 Choose AudioSuite > Other > Gain.
- 3 Adjust the Gain slider.
- 4 Click Preview to audition your changes.
- 5 Ensure that Use In Playlist is enabled.
- 6 Click Render.

Invert

The Invert plug-in reverses the polarity of selected audio. Positive sample amplitude values are made negative, and all negative amplitudes are made positive.

This process is useful for altering the phase or *polarity* relationship of tracks. The Invert plug-in is useful during mixing for modifying frequency response between source tracks recorded with multiple microphones. You can also use it to correct audio recorded out of phase with an incorrectly wired cable.



Invert

To invert the phase an audio clip (or selection):

- 1 Select the clip whose phase you want to invert.
- 2 Choose AudioSuite > Other > Invert.
- 3 Ensure that Use In Playlist is enabled.
- 4 Click Render.

Normalize

The Normalize plug-in optimizes the volume level of an audio selection. Use it on material recorded with too little amplitude, or on material whose volume levels are inconsistent (as in a poorly recorded narration).

Unlike compression and limiting, which modify the dynamics of audio material, normalization preserves dynamics by uniformly increasing (or decreasing) amplitude.



To prevent clipping during sample rate conversion, Normalize in Peak mode to no greater than the range between -2 dB to -0.5 dB. Optimum settings will vary with your program material and your Conversion Quality setting (in the Editing tab of the Preferences dialog). Observe caution when normalizing in RMS mode, as that mode of analysis does not account for instantaneous peaks.



Normalize

Level

Specifies how close to maximum level (clipping threshold) the peak level of a selection is boosted. Set this value by adjusting the Max Peak At slider, by entering a numeric decibel value below the clipping threshold, or by entering a percentage of the clipping threshold.

Channel Mode

When processing a selection that spans across multiple channels or tracks, the Normalize plug-in has two modes of operation:

Mono Normalizes each channel independently.

Multi-Input Normalizes program material across all selected channels together, so that the channels are processed relative to each other.

Peak/RMS Toggle

Switches the calibration of normalizing between Peak or RMS modes:

Peak Normalizes the input signal at the maximum possible level without clipping.

RMS Normalizes the input signal at a level consistent with the RMS (Root-Mean-Square) value, or the effective average level of the selected clip.

Normalizing Multiple Clips

When multiple clips are selected, the Normalize plug-in can search for peaks in two different modes:

Clip by Clip Searches for the peak level on a clip-by-clip basis.

Entire Selection Searches for the peak level of all clips in the selection.

To normalize an audio clip (or selection):

- 1 Select the audio you want to normalize.
- 2 Choose AudioSuite > Other > Normalize.
- 3 Adjust the Level slider.
- 4 Ensure that Use In Playlist is enabled.
- 5 Click Render.”

Reverse

The Reverse plug-in replaces the audio with a reversed version of the selection. This is useful for creating reverse envelope effects for foley, special effects, or musical effects.



Reverse

To reverse an audio clip (or selection):

- 1 Select the clip you want to reverse.
- 2 Choose AudioSuite > Other > Reverse.
- 3 Ensure that Use In Playlist is enabled.
- 4 Click Render.

Index

Numerics

- 1-2 Band EQ (Focusrite D2) 26
- 1-Band EQ (EQ III) 12
- 4-Band EQ (Focusrite D2) 26
- 660 (Fairchild Limiter) 75
- 670 (Fairchild Limiter) 77
- 6-Band EQ (Focusrite D2) 26
- 7-Band EQ (EQ III) 13

A

AAX (Avid Audio Extension) plug-ins 2

AudioSuite

- Input Mode selector 153
- Preview 153
- processing preferences 153

AudioSuite plug-ins

- DC Offset Removal 368
- Duplicate 369
- Gain 369
- Invert 370
- Normalize 370
- Reverse 371
- SoundReplacer 357
- Time Compression/Expansion 365

Aural Exciter plug-in 252

- Ax switch 257
- Bypass switch 257
- Density switch 256
- Drive meter 254
- Drive switch 256
- gain structure 258
- Harmonics control 255
- Level control 254
- Link switch 257
- LR (Left/Right) switches 258
- Mix control 256
- Null Fill control 255
- optimizing 258
- Out meter 254
- Peaking control 254

- Solo switch 257
- SPR switch 257, 259
- Timbre control 256
- Tune control 254
- Tune fader 259

AutoPan plug-in

- Angle slider 320
- Attack slider 324
- Beat Clock trigger 323
- Duration selector 323
- ENV 321
- Envelope section 324
- Envelope trigger 323
- LFO 321, 322
- LFO triggers 322
- Link To Tempo option 323
- Manual slider 320
- Manual trigger 323
- Output meters 319
- Output slider 320
- Panner section 320
- Panning display 321
- panning examples 324
- Panning Field indicator 321
- Path selectors 321
- Place slider 320
- Rate slider 322
- Release slider 324
- Side-Chain Input option 325
- Side-Chain Input selector 324
- Single trigger 322
- Sound Location indicator 321
- Spread slider 321
- surround panning 325
- synchronizing tempo 324
- Tempo controls 323
- Tempo display 324
- Threshold slider 324
- Waveform selector 322
- Width slider 320

B

- BF-2A plug-in 37
 - side-chain processing 38
- BF-3A plug-in 40
 - side-chain processing 41
- BF76 plug-in 42
 - side-chain processing 43
- Big Bottom Pro plug-in 261
 - AutoTrace switch 264
 - Compression meter 262
 - Drive control 263
 - Drive meter 262
 - gain structure 265
 - In/Out switch 263
 - Level control 263
 - Link switch 264
 - Mix control 263
 - optimizing 265
 - Out meter 262
 - Phase switch 264
 - Solo switch 264
 - Tune control 263
- block diagram 253, 262

C

- Channel Strip plug-in 44
 - bypassing effects modules 49
 - Compressor/Limiter 51, 52
 - Dynamics Graph display 50
 - Dynamics section 49
 - enabling (or disabling) effects 46
 - Expander/Gate 51
 - FX Chain 49
 - Gain Reduction meters 47
 - Input meters 47
 - Input Trim 47
 - Listen button 46
 - Phase Invert 47
 - Side Chain
 - Detection options 54
 - Filter Frequency control 54
 - Filter Type options 54
 - Side Chain Processing Graph display 54
 - Source selector 53
- Click plug-in 329
- Compressor/Limiter (Dynamics III) 62

D

- D2 27
- D3 78
- DC Offset Removal plug-in 368
- Dither plug-in 314, 316
 - bit resolution 314
 - Noise Shaping 315
- Down Mixer plug-in 326
- Duplicate plug-in 369
 - flattening a track 369
- D-Verb plug-in 166
 - Algorithm control 167
 - Church algorithm 167
 - clipping indicator 166
 - Diffusion control 168
 - Hall algorithm 167
 - Hi Frequency Cut control 168
 - input level meters 166
 - Low-Pass Filter control 168
 - output level meters 166
 - Size control 167
- dynamics
 - BF-2A 37
 - BF-3A 40
 - BF76 42
 - Channel Strip 44
 - Dynamics III 59
 - Fairchild 660 75
 - Fairchild 670 77
 - Focusrite D3 78
 - Impact 85
 - JOEMEEK SC2 Compressor 89
 - Maxim 91
 - Pro Compressor 97
 - Pro Expander 107
 - Pro Limiter 117
 - Pro Multiband Dynamics 125
 - Purple Audio MC77 136
 - Smack! 137
- Dynamics III plug-ins 59
 - common controls 59
 - Compressor/Limiter 62
 - De-Esser III 68
 - Expander/Gate 65
 - side-chain processing 70

E

- Eleven Free plug-in 266
- Eleven plug-in 266
 - advanced applications 289
 - Amp Bypass 277
 - Amp Type 276
 - navigating 273
 - amps 279
 - controls 277
 - list of 276
 - AudioSuite 290
 - Axis (On/Off) 281
 - beat clock (see Tempo Sync) 278
 - blending
 - amps and cabinets 285
 - and cab resonance 286
 - and phase 288
 - buffer 270
 - bypass
 - amp only 277
 - cabinet and mic 280
 - Cab Type 279
 - navigating 273
 - Cabinet bypass 280
 - cabinets 279
 - Category 272
 - close mic 281
 - comb filtering 288
 - combining 285
 - combo amps 279
 - condenser 280
 - cone breakup 280
 - control surfaces and unused controls 273
 - controls 273
 - CPU Usage 280
 - Depth 278
 - DSP 290
 - dynamic 280
 - flip phase 288
 - format (mono or multi-mono) 272
 - Gain 1 277
 - Gain 2 277
 - gate 276
 - Hardware Buffer for Input Calibration 270
 - Harmonic 272
 - humbucker 271
 - impedance 269
 - input
 - about guitar amps and levels 268
 - Input (Trim) 275
 - input calibration 271
 - HW Buffer 270
 - Input LED 275
 - inserting Eleven 272
 - intensity (Tremolo) 278
 - lamp (bypass) 277
 - LED colors for input calibration 271
 - load 286
 - Manufacturer 272
 - Master 278
 - Master section 275
 - mic placement 281
 - Mic Type 280
 - navigating 273
 - mics (microphones) 281
 - on- and off-axis 281
 - MIDI 273
 - Learn 274
 - tempo sync 278
 - mono / multi-mono 272
 - multichannel 272
 - multiple cabinets 285
 - noise gate 276
 - Output 275
 - phase 288, 289
 - polarity (see phase) 288
 - Presence 278
 - presets 274
 - Previous/Next arrows 273
 - pure excess 285
 - recording 282
 - dry 281
 - dry and Eleven simultaneously 283
 - processing pre-recorded tracks 284
 - Release 275
 - resonance 286
 - resources 290
 - ribbon 280
 - sample rates 272
 - Settings Files 274
 - signal flow 291
 - signal routing and track setups 281
 - single coil 271
 - Speaker Breakup 280
 - Speed 278
 - stacking 285
 - standby 277
 - stereo 272
 - tap 290
 - Tempo Sync 278

- Threshold 275
- tips 289
- tracks processed through Eleven 282
- Tremolo 278

EQ

- Channel Strip 44
- EQ III 12
- Focusrite D2 26
- JOEMEEK VC5 Meequalizer 32
- Pultec EQH-2 34
- Pultec EQP-1A 33
- Pultec MEQ-5 34

EQ III plug-in 12

- 1-Band EQ 12
- 7-Band EQ 13
- Frequency Graph display 13, 56
- gain (inverting) 13

Expander/Gate (Dynamics III) 65

external side-chain processing 84

F

Fairchild plug-ins

- 660 75

- 670 77

Focusrite D2 plug-in 26

- bypassing 28
- configurations 26
- curves 28
- disabling 28
- enabling 28
- filter controls 28
- High-Mid Peak Filter 29
- High-Pass Filter 29
- High-Shelf Filter 30
- Input Level parameter 27
- Left Channel button 31
- Link button 31
- Low-Mid Peak Filter 29
- Low-Pass Filter 30
- Low-Shelf Filter 29
- meters 27
- Output Level parameter 27
- Right Channel button 31

Focusrite D3 plug-in 78

- Attack 82
- Auto Release button 82
- brick wall limiter 79
- Compressor 78
- Compressor/Limiter 78
- Compressor+Limiter 78

- controls 80, 83
- External Key control 80, 84
- Gain Reduction meter 81
- in/out icon 81, 83
- Limit LED 83
- Limiter 79
- meters 81
- Ratio control 82
- RMS detector 79
- side-chain processing 84
- Threshold parameter 82

G

Gain plug-in 369

guitar amp simulators 266, 311

I

Impact plug-in 85

- Attack 85
- clip indicator 87
- compression ratio 87
- External On/Off 86
- gain (make-up) 86
- Gain Reduction meter 86
- Input/Output Meter 87
- Key Listen On/Off 86
- Make-Up 86
- meters 86
- Ratio 85
- Release 86
- side-chain processing 87
- Threshold 85

impulse response (IR) 198

installing plug-ins 8

internal side-chain processing 84

InTune plug-in 341

- Automatic mode 342
- Chromatic mode 344
- creating presets 344
- Display Flat Semitones option 345
- factory presets 344
- information display 344
- Meter selector 343
- Needle meter 343
- note entry fields 345
- Note Selection buttons 343
- Octave range 343
- reference frequency 343
- Single Octave mode 344

- Strobe display 343
- test tones 342
- Tone Volume slider 344
- tuner 341
- Tuner Programming screen 342, 344

Invert plug-in 370

J

JOEMEEK SC2 Compressor plug-in

- compound release circuit 90
- deadness (avoiding) 90
- overshoot 90

K

Key Listen parameter 80, 84
Key On/Off parameter 84

L

limiter

- Dynamics III Compressor/Limiter 62
- Fairchild 660 75
- Fairchild 670 77
- Focusrite D3 78

Lo-Fi plug-in 292

- adaptive quantization 293
- aliasing artifacts 293
- Anti-Alias Filter control 293
- Distortion/Saturation controls 293
- down-processing audio 292
- Linear Quantization control 293
- Noise Generator 293
- Output Meter 293
- Quantization control 293
- Sample Rate control 292
- Sample Size control 293

M

MasterMeter plug-in 347

- Clear button 353
- Clip field 354
- Export button 353
- historical metering 351
- Offset field 354
- Oversampled Clip Events browser 352
- Oversampled Level meter 353
- real-time metering 351
- Signal Clip Events browser 352
- Signal Level meter 353

View Time menu 353

Maxim plug-in 91

- Attenuation control 94
- Ceiling control 94
- controls 93
- Dither control 95
- drum limiting 92
- dynamic range of a mix 92
- dynamic range of individual instruments 92
- Histogram 91, 93
- Input Level control 93
- Limiting 92
- Link button 95, 96
- Mix control 95
- Noise Shaping control 95
- Online Help 91
- Output control 94
- peak levels 91
- Peak limiting 91, 92
- quantization noise 95
- Release control 94
- signal delay 93
- signal peaks 92
- Threshold control 94, 96
- X axis of histogram 93
- Y axis of histogram 93

Mod Delay III plug-in 215

- Delay Time 216
- Feedback setting 216
- Groove control 217
- Input meters 215
- Link button 216
- Low Pass Filter 216
- Meter setting 216
- Mix control 217
- Output Gain control 217
- Output meters 217
- Phase Invert 215
- Sync option 216
- Tempo control 216

Moogerfooger 12-Stage Phaser plug-in 233

- allpass 233
- analog filters 233
- modulation 233
- resonant filters 233
- tremolo 233
- whooshing 233

Moogerfooger Analog Delay plug-in 218

- Bucket Brigade Analog Delay Chips 218
- echo (analog delay) 218

- lo-fi 219
- sound generator 219
- Moogerfooger Lowpass Filter plug-in 230
 - auto wah 232
 - envelope follower 231
 - filters 231
 - resonance filter 230
 - whistling 231
- Moogerfooger plug-ins
 - Analog Delay 218
 - Moogerfooger 12-Stage Phaser 233
 - Moogerfooger Lowpass Filter 230
 - Moogerfooger Ring Modulator 236
- Moogerfooger Ring Modulator plug-in 236
 - Carrier Oscillator 237
 - LFO 236
 - metallic 237
 - oscillator 236
 - sinusoidal 236
 - sum and difference frequencies 236
 - tremolo 236
 - vibrato 236
- Multiband Splitter plug-in 135

N

- Normalize plug-in 370

P

- phase 288
- Pitch II
 - Input Polarity 145
- Pitch II plug-in 144
 - Effects controls
 - Delay 147
 - Feedback 147
 - Low Pass Filter 147
 - Mix 147
 - Input and Transient controls
 - Clip indicator 145
 - Follow 146
 - Input 145
 - Level indicator 146
 - Range 145
 - Threshold 146
 - Window 146
 - Pitch Shift controls
 - Coarse 146
 - Fine 146
 - keyboard 146

- Link 146
 - Ratio 146
- Pitch transposition 145
- POW-r Dither plug-in 316
 - bit resolution for Dither plug-in 316
 - Noise Shaping 316
- Pro Compressor plug-in 97
 - Attack control 103
 - Attenuation meters 99
 - Depth control 104
 - Dry Mix control 104
 - Dynamics Graph display 100
 - Input Level 98
 - Input meters 98
 - Knee control 103
 - Makeup control 104
 - Ratio control 102
 - Release control 103
 - Side Chain
 - Detection options 101
 - Filter Type options 106
 - Side Chain Processing Graph display 106
 - Source selector 104
 - Threshold control 102
- Pro Expander plug-in 107
 - Attack control 113
 - Attenuation meters 109
 - Depth control 113
 - Dry Mix control 113
 - Dynamics Graph display 109
 - Hold control 113
 - Hysteresis control 113
 - Input Level 108
 - Input meters 108
 - Knee control 112
 - Ratio control 112
 - Release control 113
 - Side Chain
 - Detection options 111
 - Filter Type options 116
 - Side Chain Processing Graph display 116
 - Source selector 114
 - Threshold control 112
- Pro Limiter plug-in 117
 - Ceiling control 120
 - Character control 121
 - Input Level 118
 - Input meters 119
 - Release control 121
 - Threshold control 120

Pro Multiband Dynamics plug-in 125

- Attack control 133
- Automatic Gain control 131
- band controls 130
- band meters 131
- bypassing bands 131
- Crossover Frequency controls 127
- Depth control 132
- detection options 133
- disabling bands 130
- FFT display 126
- FFT display options 128
- Flip mode 131
- Gain controls 128, 132
- linking bands 130
- meters 129
- Release control 133
- Side Chain 134
- Slope control 133
- soloing bands 130
- source linking 128
- Threshold control 132

Pro Subharmonic plug-in 294

- Drive control 300
- filters 297
- frequency display 296
- frequency range controls 298
- Gain controls 299
- input level 295
- input meters 295
- MIDI control 304
- Mix controls 301
- output level 296
- output meters 296
- Surround Send controls 302

Pultec EQH-2 plug-in 34

Pultec EQP-1A plug-in 33

- phase (EQ filters) 35
- program equalization 33
- smooth EQ 33

Pultec MEQ-5 plug-in 34

pumping 76

Purple Audio MC77 plug-in 136

R

Recti-Fi plug-in 305

- Alternating Rectification 306
- Alt-Max Rectification 306
- Mix control 307
- negative excursion period of waveform 306
- Negative Rectification 306
- Output Meter 307
- Positive Excursion 306
- Positive Rectification 306
- Post-Filter 307
- Pre-Filter 305
- Rectification 306
- Subharmonic synthesis 307
- zero crossing 306

Reel Tape Delay plug-in 220

- Bass control 222
- Feedback control 221
- Mix control 222
- Noise parameter 222
- presets 223
- Speed control 221
- synchronizing to session tempo 223
- Treble control 222
- Wow Speed parameter 222
- Wow/Flutter control 222

Reel Tape Flanger plug-in 238

- Feedback control 240
- Invert parameter 240
- LFO Depth control 240
- LFO Rate control 240
- Mix control 240
- Noise parameter 241
- presets 242
- Range control 239
- synchronizing to session tempo 241
- Wow/Flutter control 240

Reel Tape plug-ins 238

- Drive control 221, 239, 308
- Output control 221, 239, 308
- Tape Formula control 221, 239, 309
- Tape Machine control 221, 239, 308

Reel Tape Saturation plug-in 308

- Bias control 309
- Cal Adjust control 309
- Noise control 309
- presets 310

- removing plug-ins 8
- reverb
 - D-Verb 166
 - Reverb One 169
 - ReVibe II 178
 - Space 192
- reverb (about) 194, 195
- Reverb One plug-in 169
 - 100% Wet control 171
- acoustic environments 170
- anechoic chamber 170
- Attack control 172
- Band Breakpoints 175
- Chorus controls 172
- clipping indicator 177
- Crossover sliders 176
- Decay Ratio control 172
- Delay Master control 174
- Depth control 172
- Diffusion control 173
- Dynamics controls 171
- early reflections 170
 - Early Reflect On 174
 - Early Reflection control 173
 - ER (early reflection) button 176
 - ER Settings control 174
 - presets 174
 - simulating 173
- Frequency control 175
- HF Cut control 175
- HF Damp control 176
- input level meters 177
- late reverberation 170
- Level control 172, 174
- Master Mix controls 171
- meters
 - clipping indicator 177
 - input 177
 - output 177
- Output Level meters 177
- Pre-delay 170
 - presets 173
- Rate control 172
- RC (reverb contour) button 176
- reverb character 170
- reverb graphs
 - editing 175
 - Reverb Color 176
 - Reverb Contour 176
 - Reverb EQ 175
- simulating early reflections 173
- Size control 173
- Spread control 173, 174
- Stereo Width control 171
- Threshold control 172
- Time control 172
- tool tips 177
- Wet/Dry control 171
- Reverse plug-in 371
- ReVibe II plug-in 178
 - 100% Dry Mix button 185
 - 100% Wet Mix button 185
 - Attack Shape control 182
 - Attack Time control 182
 - bipolar controls 9
 - Center control 184
 - Chorus On button 185
 - Chorus section 185
 - clip indicator 180
 - Color graph display 186
 - Coloration control 183
 - Contour display 187
 - Depth control 185
 - Diffusion control 182
 - Early Reflection Level control 183
 - Early Reflection Pre-Delay control 183
 - Early Reflection section 182
 - Early Reflection Spread control 183
 - Early Reflections button 187
 - Early Reflections On button 183
 - EQ graph display 186
 - Front button 188
 - Front control 184
 - High Frequency Color control 184
 - High Frequency control 186
 - High Frequency Crossover 187
 - High Frequency Ratio 187
 - High Frequency Rear Cut control 186
 - High Gain control 186
 - Input control 184
 - Input/Output meter 180
 - Level control 181
 - Levels section 184
 - Low Frequency Color control 184
 - Low Frequency control 186
 - Low Frequency Crossover 187
 - Low Frequency Ratio 187
 - Low Gain control 186
 - Mix section 185
 - Next and Previous Room Type buttons 181

- Pre-Delay control (reverb tail) 182
- Pre-Delay Link button 183
- Rate control 185
- Rear button 188
- Rear ER control 184
- Rear Level Link button 184
- Rear Reverb control 184
- Rear Shape control 182
- Reverb Contour button 187
- Reverb section 181
- reverb tail controls 181
- Reverb tail type 181
- Reverb Type 180
- Reverb Type menu 181
- Room Coloration section 183
- Room Type 180
- Room Type Category menu 181
- Room Type Name menu 181
- Size control 181
- Spread control 182
- Stereo Width control 185
- supported channel formats 178
- Time control 181
- Wet/Dry control 185
- ReWire plug-in
 - and voices 334
 - automating input switching 339
 - client applications 332
 - looping playback 339
 - meter changes 338
 - MIDI automation 336
 - MIDI continuous controller (CC) data 336, 338
 - MIDI Output selector 336
 - quitting client applications 338
 - recording MIDI over 337
 - requirements 334
 - signal flow for audio and MIDI 333
 - software synthesizer 332
 - tempo sync 338
 - track count 334
 - using with Pro Tools 335

S

- SansAmp PSA-1 plug-in 311
 - amp simulation 311
 - buzz 312
 - cabinet simulation 311
 - crunch 312
 - distortion 312
 - equalization 311
 - harmonic generation 311
 - lo-fi textures 311
 - punch 312
 - tube sounds 311
 - unity 312
 - wah 312
- Sci-Fi plug-in 243
 - Effect Amount control 244
 - Effect Frequency control 244
 - Envelope Follower 244
 - Freak Mod 244
 - Input Level 243
 - LFO (Low Frequency Oscillator) 244
 - Mod Amount/Mod Rate control 245
 - Mod Slewing control 244
 - Modulation Type control 244
 - Output Meter 245
 - Resonator– 244
 - Resonator+ 244
 - Ring Mod control 243
 - ring modulation 243
 - Sample+Hold control 244
 - Slewing 244
 - triangle wave 244
 - Trigger and Hold 245
- side-chain processing 41, 43, 53, 70, 84, 87, 104, 114
- Signal Generator plug-in 355
 - Frequency control 355
 - Level control 355
 - pink noise 355
 - Signal control 355
 - white noise 355

- Smack! plug-in 137
 - adjusting input 138
 - Attack control 139
 - band emphasis 140
 - clip indicator 141, 142
 - compression modes 138
 - Distortion control 141
 - hard limiting ratio setting 139
 - high-pass detector 140
 - high-pass filter 141
 - Input meter 142
 - key input 142
 - level 137
 - limiting 139
 - Meter Mode button 141
 - Norm mode 138
 - Opto mode 138
 - output gain 139
 - Output meter 142
 - Ratio control 139
 - reducing waveform distortion 138
 - Release control 139
 - Side-Chain EQ control 140
 - side-chain frequency filters 140
 - side-chain processing 142
 - threshold and ratio 139
 - unity gain 138
 - VU meter 141
- SoundReplacer plug-in 357
 - Crossfade control 360
 - Dynamics controls 361
 - Load/Unload Sound icons 359
 - MIDI-triggered samplers 358
 - Mix control 360
 - Online Help 361
 - Peak Align control 360
 - Trigger envelope 358
 - Trigger markers 358
 - Trigger Threshold 359
 - waveform display 358
 - Zoomer 358, 360
- Space plug-in 192
 - clip indicator 205
 - Control group selector 209
 - convolution reverb 195
 - Decay controls 212
 - Delay controls 209
 - Early Reflection controls 210
 - EQ controls 211
 - impulse computer 196

- impulse response (IR) 198
- installing IR packages 207
- IR browser 206, 207
- IR channel compatibility 200
- IR channel formats 199
- IR filename conventions 199
- IR formats 198
- IR library 213
- IR Name 203
- Level controls 209
- Meters display 205
- Online IR Library 207
- Picture Preview mode 204
- Preferences mode 205
- presets 201, 212
- primary controls 208
- Quick browser 203
- Snapshot menu 203
- Snapshot mode 204
- snapshots 201, 212
- system design 196
- Waveform mode 203

T

- TCE Trim tool 153
- Tel-Ray Variable Delay plug-in 224
 - Electronic Memory Unit 224
 - tuna can 224
- Time Compression/Expansion plug-in 365
 - Accuracy control 366
 - Crossfade control 365
 - destination fields 365
 - Minimum Pitch control 366
 - Ratio control 365
 - Source and Destination controls 365
- Time Shift plug-in 148
 - Audio Gain control 149
 - Audio Mode pop-up menu 149
 - Audio Range pop-up menu 149
 - Audio section 149
 - changing pitch 154
 - changing time 154
 - changing time and pitch 154
 - Clip indicator 149
 - Decay Rate 152
 - displays and controls 148
 - Follow button 151
 - Formant section 151
 - Input modes 153
 - Level indicator 150

- Monophonic mode 149
- Original time 150
- Pitch section 152
- Pitch Shift 152
- Polyphonic mode 149
- post production workflow 155
- Processed time 150
- pull up/pull down TCE percentages 155
- Rhythmic mode 149
- Speed 150
- Tempo displays 150
- Threshold control 152
- Time section 150
- timebase 150
- Transient section 151
- Transpose 152
- Unit pop-up menu 150
- Varispeed mode 149
- Window 152
- TimeAdjuster plug-in 226
 - DSP delay compensation 227, 228
 - phase cancellation 227
 - Phase Invert button 226
- Trim plug-in 367

V

- variable-mu 75
- Vari-Fi plug-in 156
 - Fades controls 157
 - Selection controls 156
 - Slow Down control 156
 - Speed Up control 156
- vinyl mastering 77
- Voce plug-ins
 - Voce Chorus/Vibrato 246, 247
 - Voce Spin 247
 - Rotor Balance 248

X

- X-Form plug-in 158
 - 2x, 4x, and 8x Range buttons 160
 - Audio section 158
 - Audio Type pop-up menu 159
 - AudioSuite Input 162
 - AudioSuite Preview 162
 - AudioSuite processing preferences 162
 - Clip indicator 159
 - Formant Shift control 161
 - Gain control 159
 - Level indicator 159
 - Monophonic mode 159
 - Original time 159
 - Pitch section 158, 161
 - Pitch Shift control 161
 - pitch shifting a selection 163
 - Poly (Faster) mode 159
 - Polyphonic mode 159
 - post-production workflow 164
 - Processed time 159
 - processing audio 163
 - pull up/pull down TCE percentages 164
 - Sensitivity control 160
 - TCE Trim tool 162
 - Tempo (original and processed) 159
 - Time section 158, 159
 - Time Shift control 160
 - time shifting a selection 163
 - Transient section 158, 160
 - Transpose control 161
 - Unit timebase selector 159
 - Window control 161

Z

- z (Eleven input impedance) 269



Avid
280 N Bernardo Avenue
Mountain View, CA 94043 USA

Technical Support (USA)
Visit the Online Support Center at
www.avid.com/support

Product Information
For company and product information,
visit us on the web at www.avid.com