

# Avocet

With REMOTE II



## OPERATOR'S MANUAL

Version (8.0)  
20140630



2117 East 5th Street  
Superior, WI 54880 USA  
tel: 715-398-3627  
fax: 715-398-3279  
[www.cranesong.com](http://www.cranesong.com)

© 2004, 2005, 2006, 2009, 2014 Crane Song, LTD. Subject to change without notice.  
the U.S.A.

Printed in

First time power up	6
Main Functions	8
Talk back	9,12
Gain Trims	10
Shift Mode	11
Headphone controls	13
Output 3 mode select	14
Surround mode	17
Reboot	22
Internal configuration jumpers	24
Back panel	30
Surround interconnect	31
Remote control size	33
Accessory connector	34
Revision History	35
5.1 interconnect cable pin out	36
Subwoofer alignment alignment by Bob Katz	39
Headphones setup - external amplifier	47
External audio output	51
Avocet alignment	53
Signal flow diagram	55
Digital Metering cable pin out	56

## IMPORTANT SAFETY INSTRUCTIONS

1. Read these instructions
2. Keep these instructions
3. Heed all warnings
4. Follow all instructions
5. Do not use this apparatus near water
6. Clean only with dry cloth
7. Install in accordance with the manufacturer's instructions
8. Do not install near any heat sources such as radiators, heat registers, stoves, or other apparatus (including amplifiers) that produce heat
9. Protect the power cord from being walked on or pinched particularly at plugs and the point where they exit from the apparatus
10. Only use attachments/accessories specified by the manufacturer
11. Unplug this apparatus during lightning storms or when unused for long periods of time
12. Refer all servicing to qualified service personnel. Servicing is required when the apparatus has been damaged in any way, such as power-supply cord or plug is damaged, liquid has been spilled or objects have fallen into the apparatus, the apparatus has been exposed to rain or moisture, does not operate normally, or has been dropped
13. CAUTION: To disconnect the unit completely from the MAINS, unplug the unit. Turning the power switch off does not disconnect the unit completely from the MAINS.

“Avocet” is designed to solve the problems of accurate monitoring and volume control as required by workstation users, studios and mastering rooms alike. Avocet is a stereo controller with three digital inputs, three analog inputs and a headphone system. All digital signals are up-sampled and jitter reduced to ensure highest accuracy during D/A conversion. Options are available to change the D/A mode, all though the default mode has been chosen as more accurate.

Avocet’s many features including; dim, mute, phase, mono, and 16 bit truncation functions, plus a speaker select switch that sends line level balanced audio to one of three outputs. The six input sources have on the fly gain trim capability.

An accessory connector has extra functions for the technically minded. They are; buffered stereo output, mono output, talk back mic output, headphone bus output, and several input control functions such as; talk back enable, mute and input selection control that could be used for a pre-listen or solo command. This connector is also used to tie audio boxes together for surround operation.

The internal headphone amplifier can be fed from the program source or an external input. Provisions for a talk back function are included.

The three headphone sources are;

- The analog AUX input
- Main, meaning the audio source selected by the input button
- Program, meaning the audio source selected by the input button.  
However the level control, mono and phase buttons also apply to the program source.

All three phone sources have individual gain settings controlled by the green knob.

The talkback mic (not supplied and there is no phantom power) is hooked into the xlr connector on the remote. The talk back mic signal is mixed into the headphone amplifier along with the selected headphone source. By sending a cue mix to the Aux input you can use the headphone system for doing overdubs in the studio and have communication to the artist. At the same time the main audio path can operate independently of the headphone system

## SURROUND

By using 3 two channel audio boxes Avocet will function as a 5.1 system, and 4 audio boxes makes a 7.1 system. See the speaker setup information. This function allows intergrating, both surround and stereo speaker systems. A metering system is under discussion. A specially made accessory cable connects the audio boxes when working surround.

Systems that ship surround from the factory have lables on them as to how the audio boxes are configured.

Notes:

When configuring the units for Surround, if the system was not purchased as Surround please consult the factory

This manual applies to Avocet version 1.5 with remote II, the older manual is available on the web site

# FIRST TIME POWER UP

The first time that Avocet is powered up, it should be initialized. This is done by pushing all three output select buttons at the same time. This sets up the remote for proper operation. It also resets the user settings:

All gains, main and phones are set to zero  
Output 1 is the selected output  
DAW is the input selected  
Phones are set to the Aux input  
Stereo speaker selection is selected  
All offsets are cleared

**The remote cable must be attached and screwed down before power up.**

Take the time to look at the following pages and see how the buttons work. After that, you should be good to go.

Almost all user selections and gains are remembered by Avocet and restored on power up. The headphone button and the talk button positions are not remembered

Configuration information for surround or stereo only systems are in the back pages of this manual.

## AUDIO PATH

The main audio path is discrete class A electronics with a stepped attenuator for gain control. All switching and gain control functions in the main audio path is done with relays. Yes they make acoustic clicks when operating.

The headphone audio path is done with high quality integrated circuits. The D/A converter uses the latest technology integrated circuits.

## POWERED MONITORS, POWER AMPS WITH NO GAIN CONTROL

Most powered monitors do not have a level control that is meaningful. This results in the need to trim Avocet's output gain. In order to do this and not add any amplifier stages an output pad is supplied. This pad is to be placed at the input of the power amp. Not at Avocet's connector. The pad has a range of 6 to 20 db of loss and is preset to a 10 db loss.

## BUTTON FEEDBACK

When holding down a button for gain trim; or speaker setup, the led now provides feedback that the button was held for the required time. The led will wink out for 1/2 second and then come back on. In the previous version there was no feedback to the user on mode change. This applies to the 6 input select buttons, the mono button, and the speaker buttons for selecting the mono output channel.

# MAIN FUNCTIONS

Truncates the digital input to 16 bits. For checking what 16 bits sounds like

Channel Selection to 7.1 surround

SHIFT MODE to reach the setup functions (they have the smaller text on the panel)

Selects which speaker output 1 of 3

Changes the phase of one channel, disabled in surround mode

Monos the stereo source

Talk back button sends the talk mic into the head-phone output. It is push-on push-off, however holding it for 2 seconds allows quick release - non latching

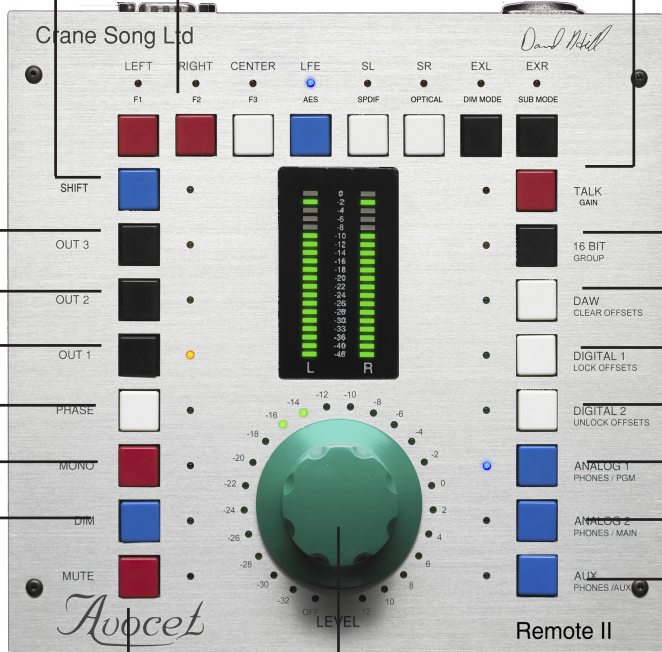

Dims the main audio path. The dim level is set by turning the level while dim mode is active. Selection of phones is over ridden by selecting dim.

Input selection  
The DAW input will be S/PDIF, AES or Optical selected in Shift mode. Digi- 1, 2 are AES, the analog inputs are Balanced

Input level when Phones or Dim modes are not selected  
1 DB steps through most of the range

Mute kills the main output. On power up Avocet is muted



# Talkback Operation

Talk mic is on when the LED is on. It has push-on, push-off operation or latching. However if the talk button is held for one half second, talk back releases when the button is released, non latching

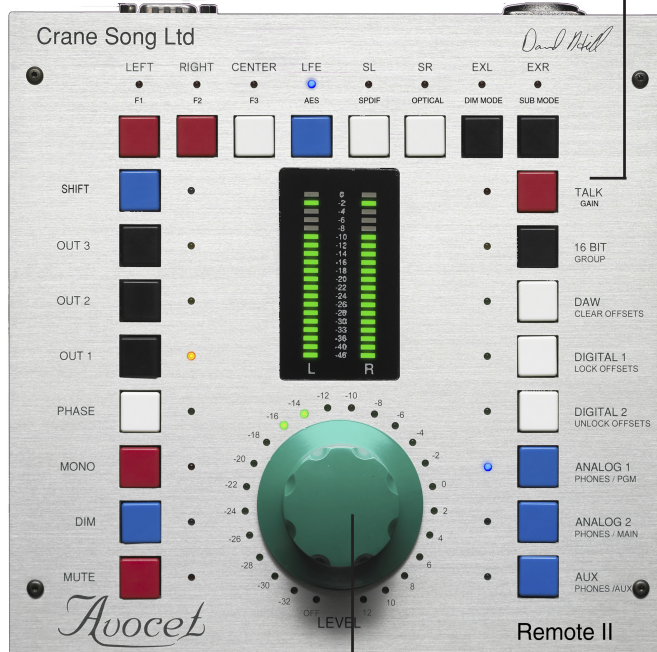

The monitor level can be set when the talkback button is pushed. The monitors can be dimmed to off or a level that is below feedback. This will allow comminution in both directions while in talk mode.

When in talkback all other buttons are locked until talkback is released

# Gain Trim

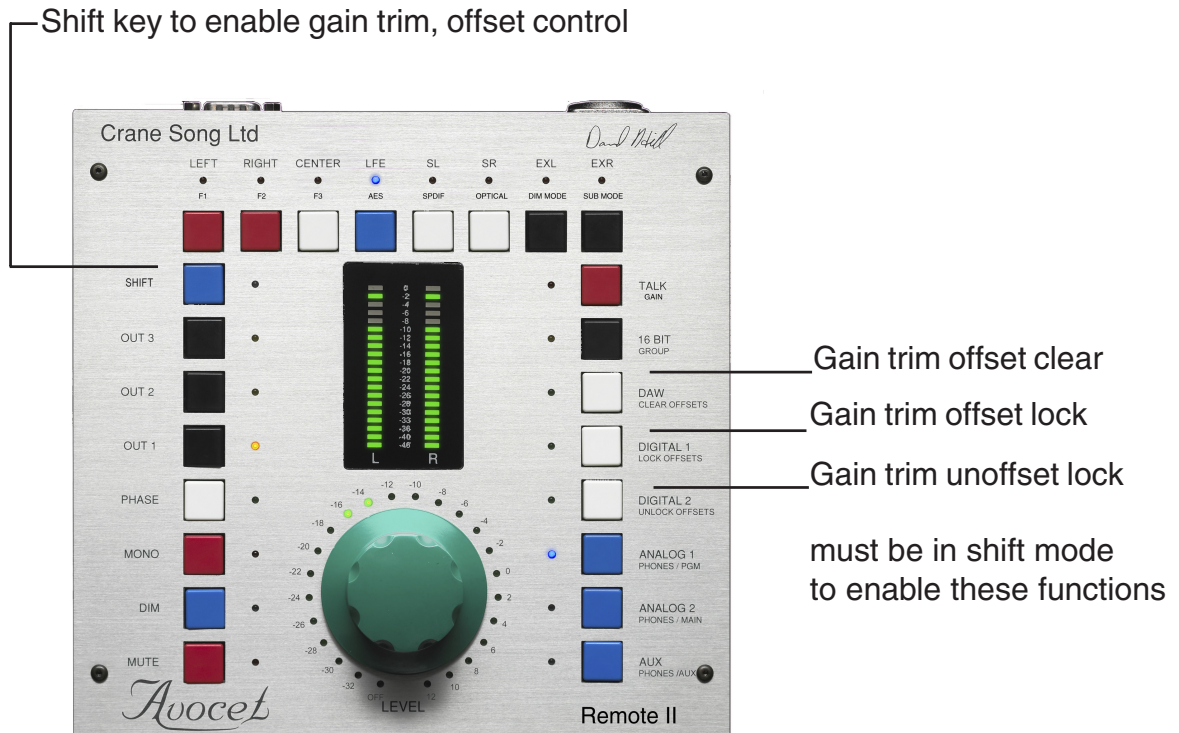

If one presses and holds the input select button a second time it will enable the input gain trim mode. It requires about one half second of hold time to enter the trim mode. Trim mode allows changing the input level on the selected input relative to all other inputs. Gain trim has an offset range of plus or minus 10 db in 1 db steps. By pressing the input button a third time, the input will return to normal operation while remembering the gain trim. Selecting any other input will also exit the trim adjust mode.

Gain trim can be cleared, locked or enabled by using the Shift key to reach the desired selection.

The mono function also has a gain trim for level matching in surround. After selecting mono, if one presses and holds (for one half second) the mono select button it will enter the input gain trim mode. To leave the gain trim mode press and hold the button for one half second. Pressing the button for less time will cause the gain trim to be remembered and the mono mode to be exit.

In normal operation all input gains will track. At the end of the stepped attenuator range the offset gains could reach a limit where they will not change. As an example if you trim an input up by 10 db and then move the main gain to max that input will be max +10 which is not possible. Bringing the main gain back down, the 10db offset will still exist. The same thing will happen on the bottom end of the control range.

# SHIFT MODE SETUP FUNCTIONS

Changes DIM  
from relative LEVEL  
to absolute LEVEL

In the Shift Mode Select the source  
for the DAW input between  
AES, SPDIF, OPTICAL

Changes output 3  
to work in parallel  
with outputs 1 and 2  
for use as a sub woofer  
output

Functions F1, F2, F3  
for future features

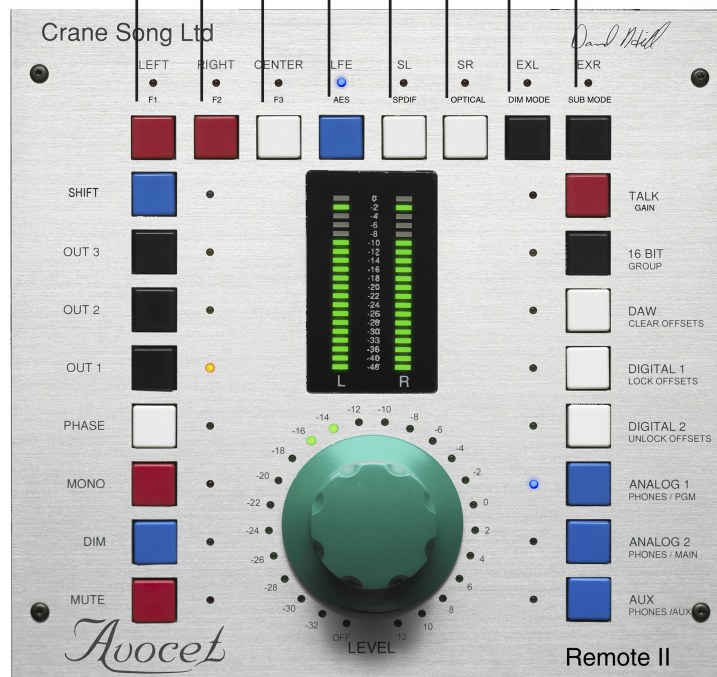

# SHIFT MODE SETUP FUNCTIONS

## TALK BACK MIC GAIN

TALK BACK MIC GAIN is changed by selecting the TALK button when in the SHIFT MODE. Turning the gain knob changes the mic gain. The gain steps are 3 db steps to 72 db of gain



GAIN

# SHIFT MODE Headphone Setup

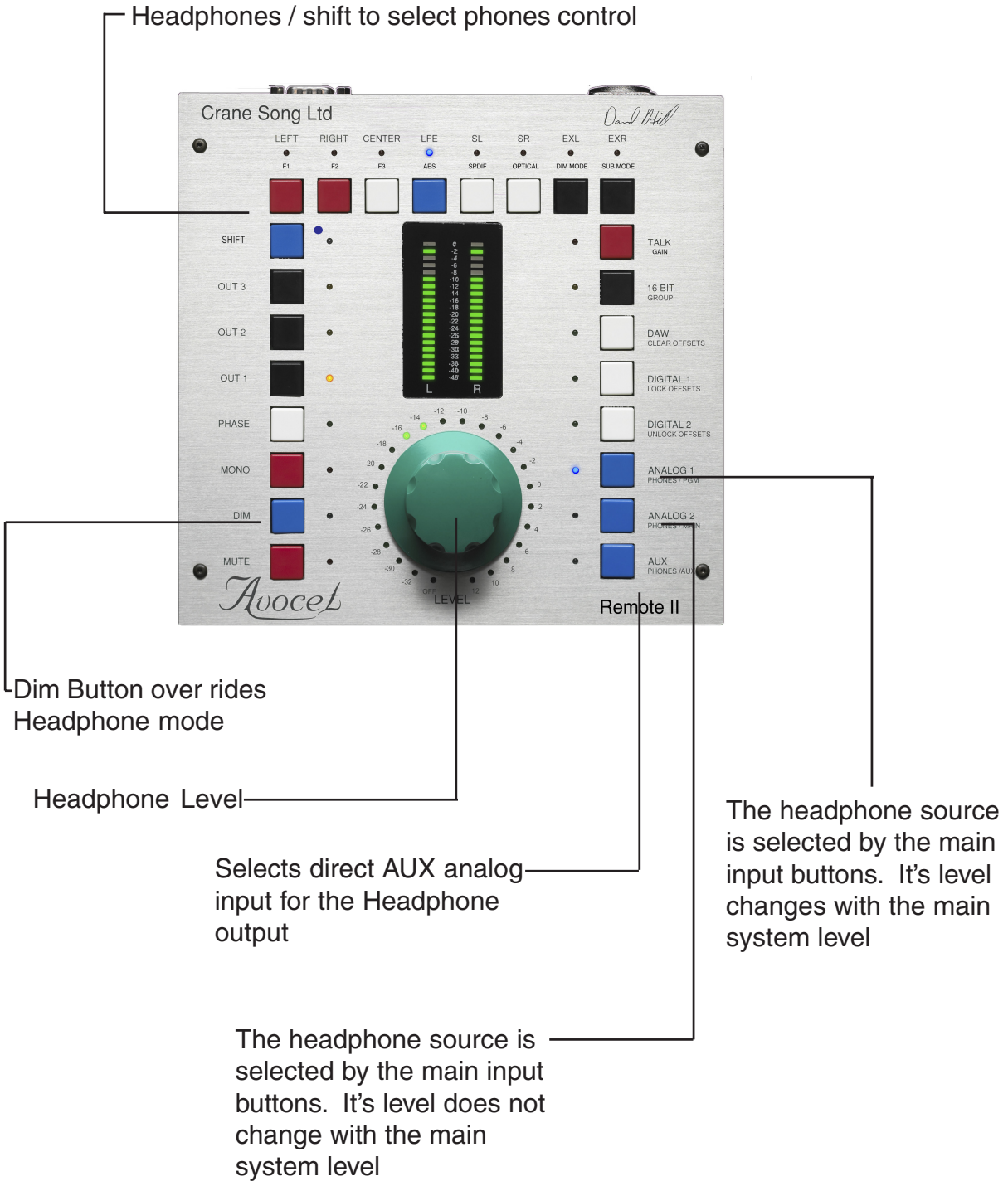

# Shift Mode Output 3 Mode

*as sub woofer on-off*

With this button selected in the shift mode. OUT 3 is converted to work as a Sub Woofer output. It is full range unfiltered audio that can be turned ON or OFF with OUT 3. Thus allowing outputs 1 and 3, or 2 and 3 to be on at the same time. If this is not selected, OUT 3 works as a normal third speaker system output

Shift to select control



Output 3 does not provide any filtering or mono summing. Using this as an output to turn a sub woofer on or off assumes that either there is external summing and filters for the sub woofer or that there is stereo sub woofers with filtering which is a better method.

In normal operation one should set the power amp gain, so that your normal listening level is with the gain knob at 1 o'clock. There is a supplied adjustable pad for powered monitors and power amps that have no gain control.

## Speaker selects - Mute and Solo



Channel or speaker control is determined by the top row of buttons. The channel is on when the led is on. This applies to all modes of operation. The channels are Left, Right, Center, LFE, Surround Left, Surround Right, Extra Left, Extra Right.

If one holds down a channel select button for one half second or more the selected channel will be soloed. The led on the soloed channel will flash indicating that this is the soloed channel. Other channels can be turned on and off in the solo mode. By holding down the flashing / soloed channel a second time ( for one half second) the system will return to the pre-soloed speaker selection. If one holds down a different channel select for the one half second time period un-soloing returns to the selected channels prior to having selected a new soloed channel.

Speaker select buttons now allow multiple selection at a time

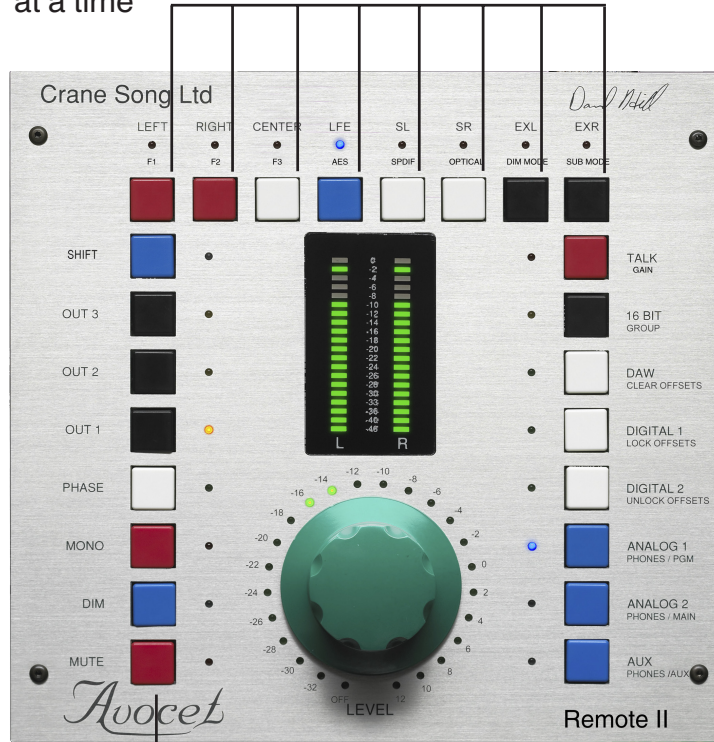

Mute will over ride all functions including Talk Back



# Changing the speaker setup from Stereo to Surround Default mode

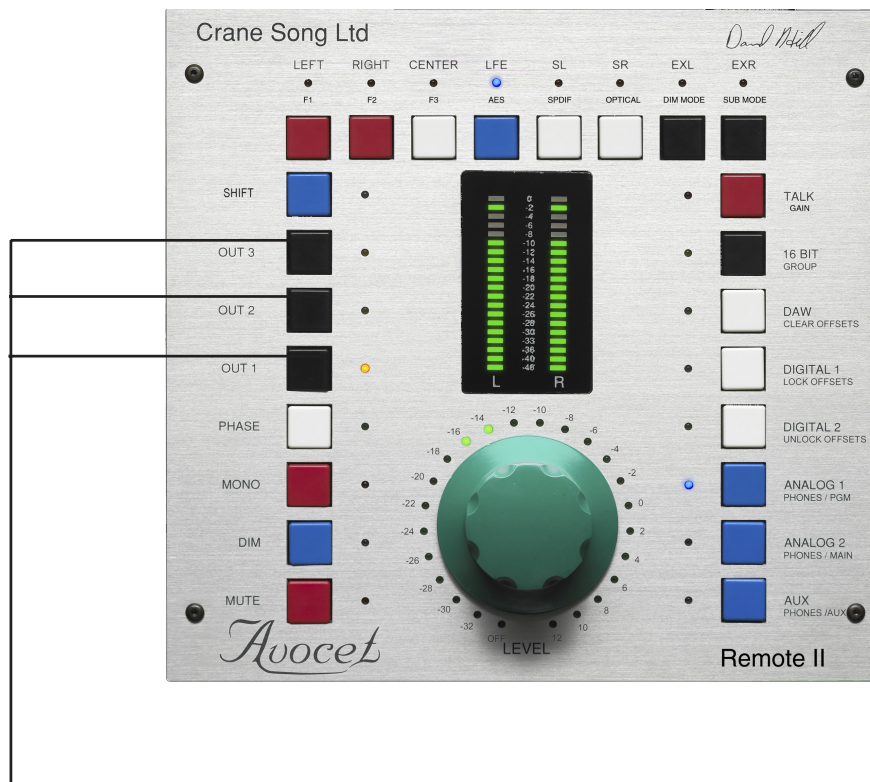

By pressing any one of the speaker select buttons and holding it for about 0.5 seconds will put Avocet into the speaker set up mode. If SHIFT is selected the speaker setup is disallowed.

Selecting the center channel button will cause the center channel be the mono speaker when selecting mono. This is the surround mode of operation

Selecting the left, right, or both, (left and right) will disable the surround channels. This selects which speaker is the mono speaker, when the mono function is selected. This is the stereo mode of operation

To exit the setup mode touch the output select button a second time During Speaker setup the Sub Woofer mode is disabled.

Once set up, switching between the speaker systems is user transparent.

# Speaker Setup

## Transparent Surround Mode

In OUT 1 SETUP SELECT turning this button on will cause the unit to be in surround mode at all times (Transparent Surround Mode) the mono speaker select function determines the active speakers when mono is selected

**MONO SPEAKER SELECT**  
Selects which speaker is the mono output when mono is selected

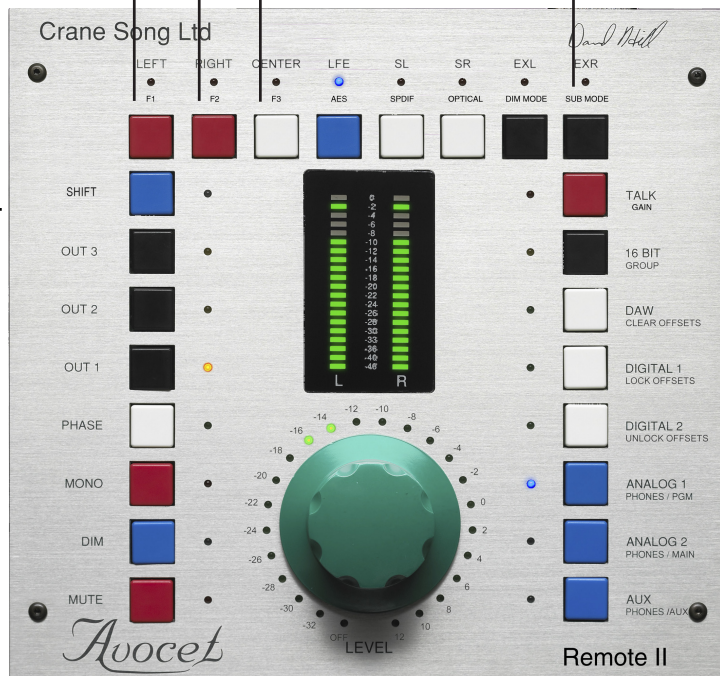

# Group Function

This shows the key grouping

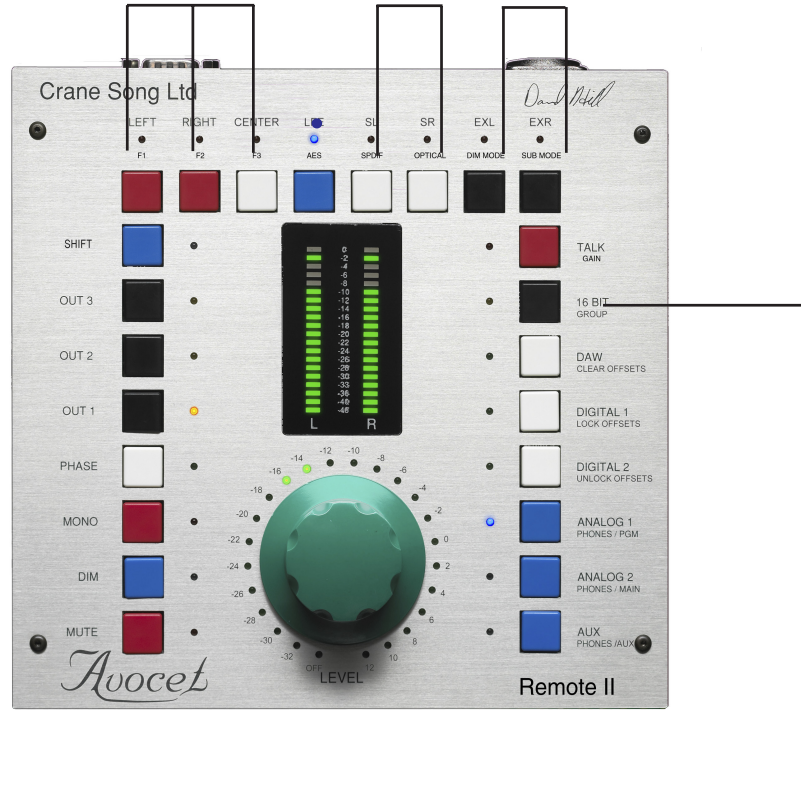

The group function is reached by the phones / shift button and then selecting the group button. What it does, is in surround mode, it groups together Left, Right, Center to function as one button, Surround Left and Surround Right as one button, and Extra Left and Extra Right as one button

# Changing the speaker setup from Stereo to Surround

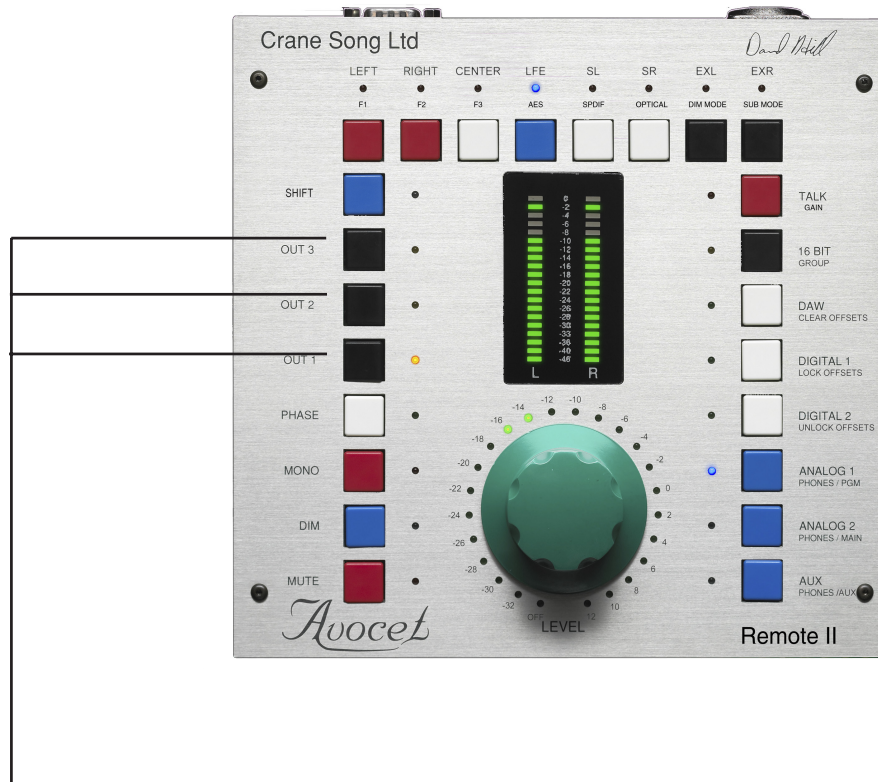

By pressing any one of the speaker select buttons and holding it for 5 seconds will put Avocet into the speaker set up mode.

Pressing the center channel button will make the center channel be the mono speaker when the mono function is selected. This is the surround mode of operation

Selecting the left, right, or both, left and right will disable the surround channels and select which channel is the mono speaker, or speakers, when the mono function is selected. This is the stereo mode of operation

To exit the setup mode touch the output select a second time

Once set up, switching between the speaker systems will be transparent.

There is no channel summing when going from surround down to stereo.

# Functions that can change

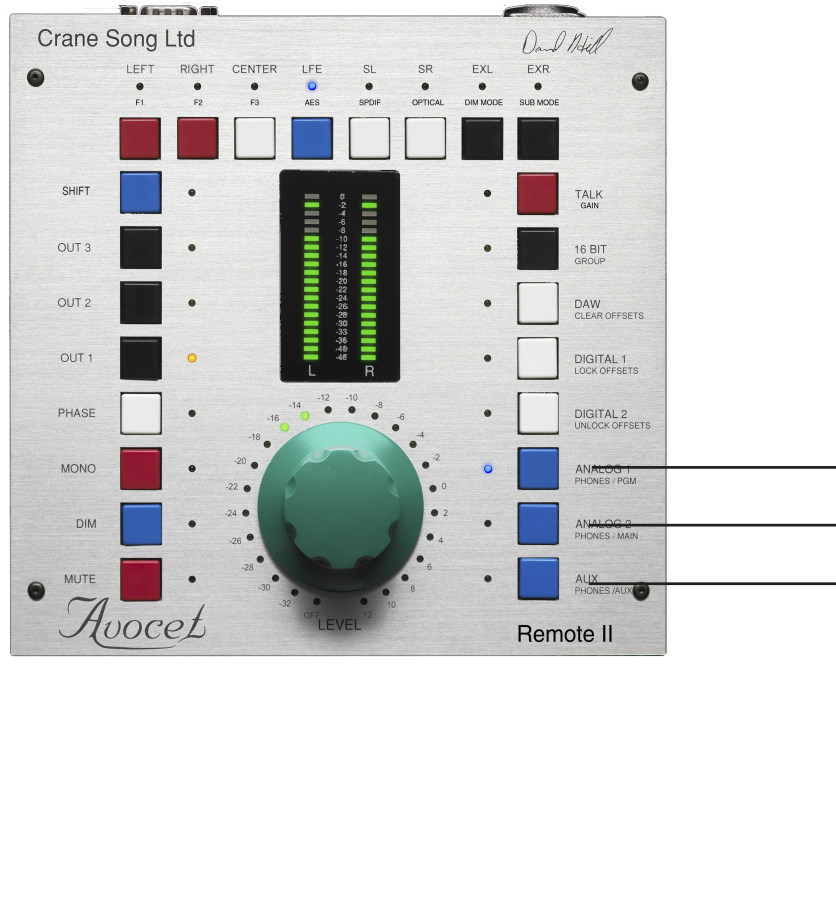

There are trim pots on the back of the main unit for the analog gain trim. These have a range of 8 db

There is a high gain mode selected by an internal jumper. This will add 14 db of gain to the Analog 2 input. There is a small pop that can be heard when the gain changes by 14 db. This is a result of the switch contacts and happens only when high gain is selected

# Clearing the internal settings - System Reset

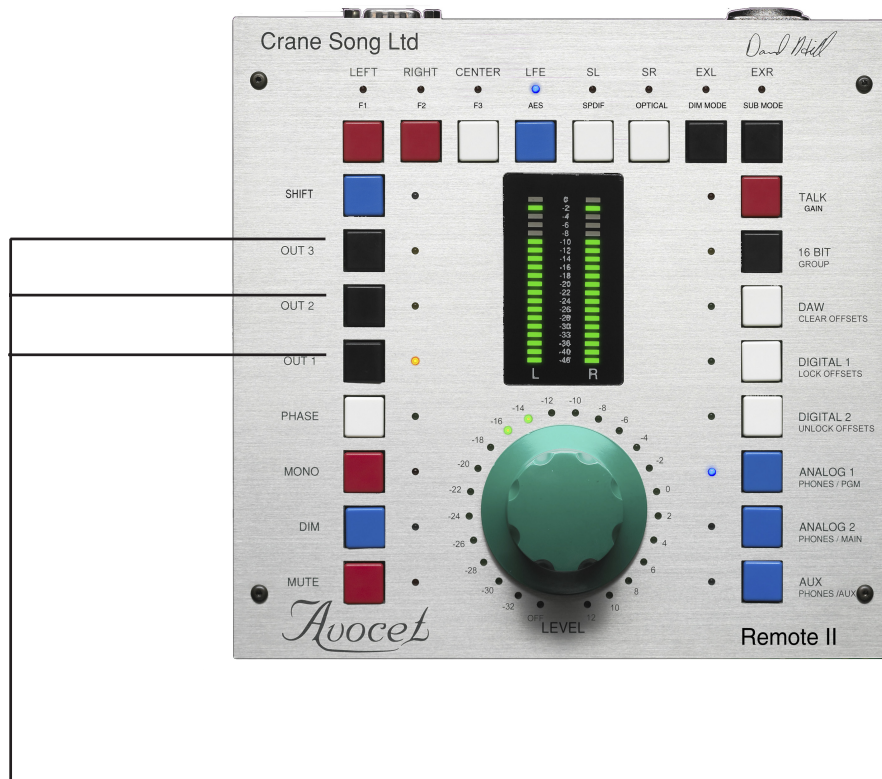

By pressing all three output selection buttons at the same time Avocet will reset all of it's internal settings. This is the same as rebooting the remote.

- All gains, main and phones are set to zero
- Output 1 is the selected output
- DAW is the input selected
- Phones are set to the Aux input
- Stereo speaker selection is selected
- All offsets are cleared

## Rev 8 D/A jumpers and Trims

### Main Audio Path Digital level trims

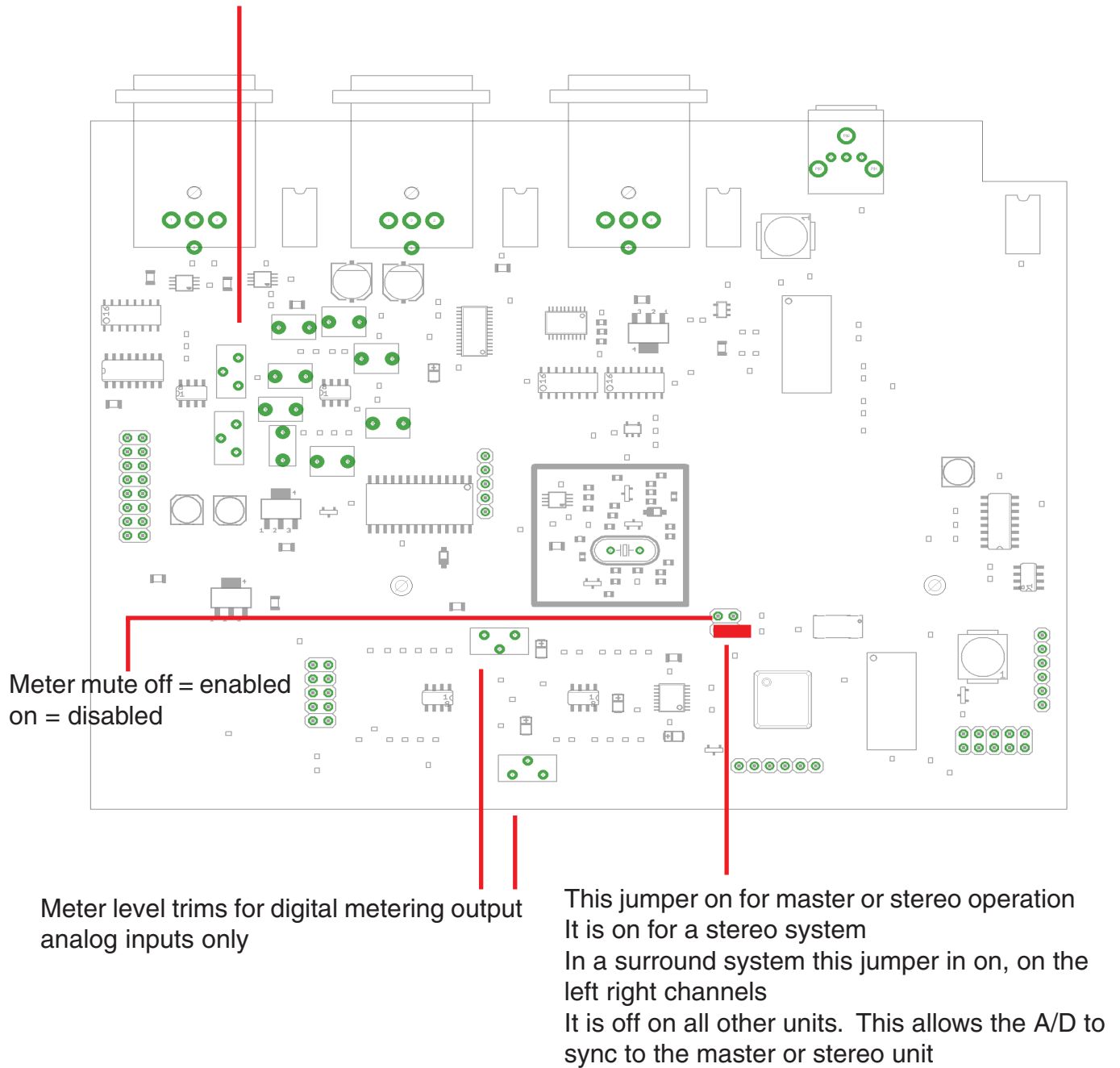

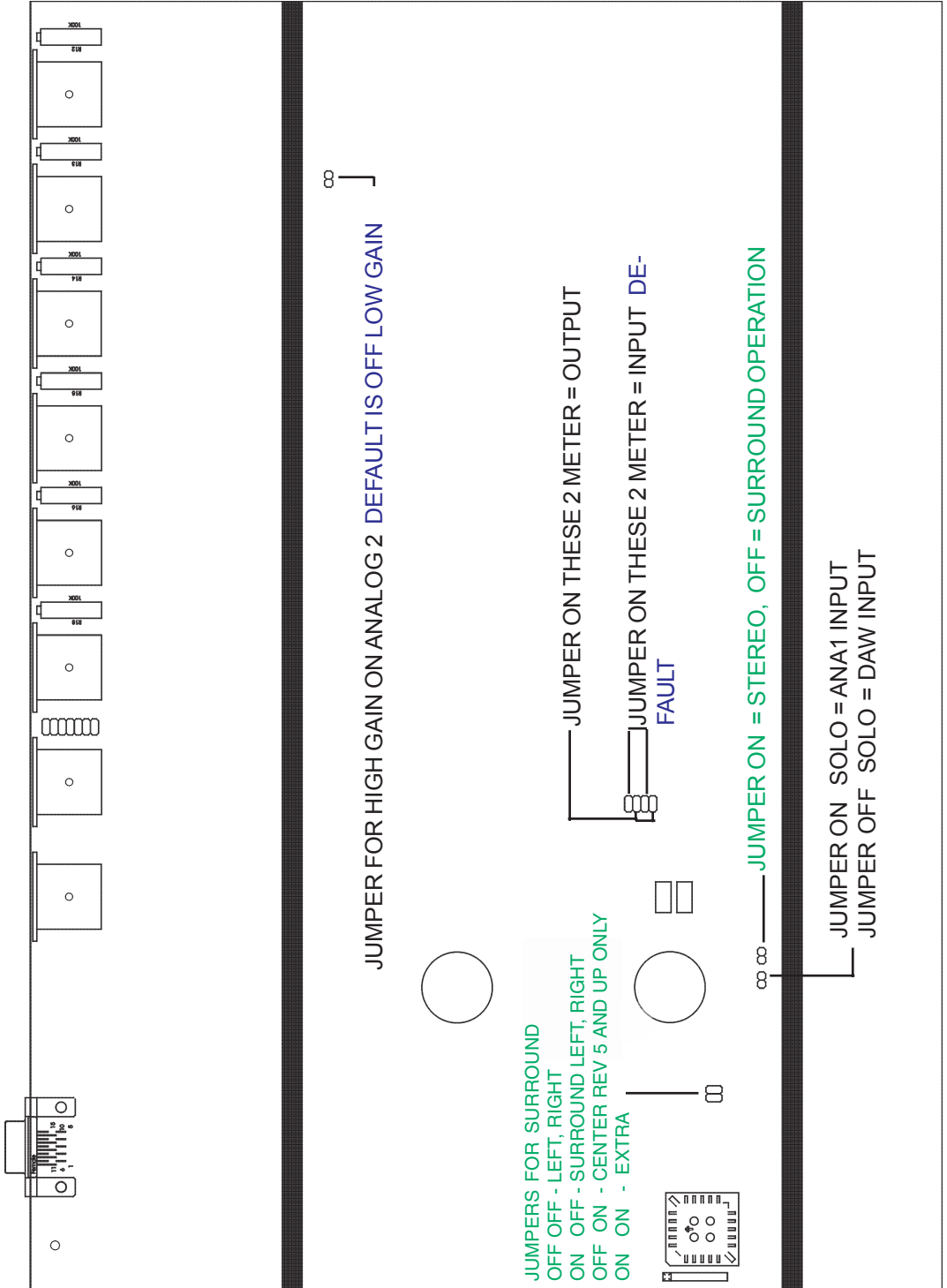

REV 4 pcb

Do not change jumpers or adjust the trim pots unless you are sure of what you are doing



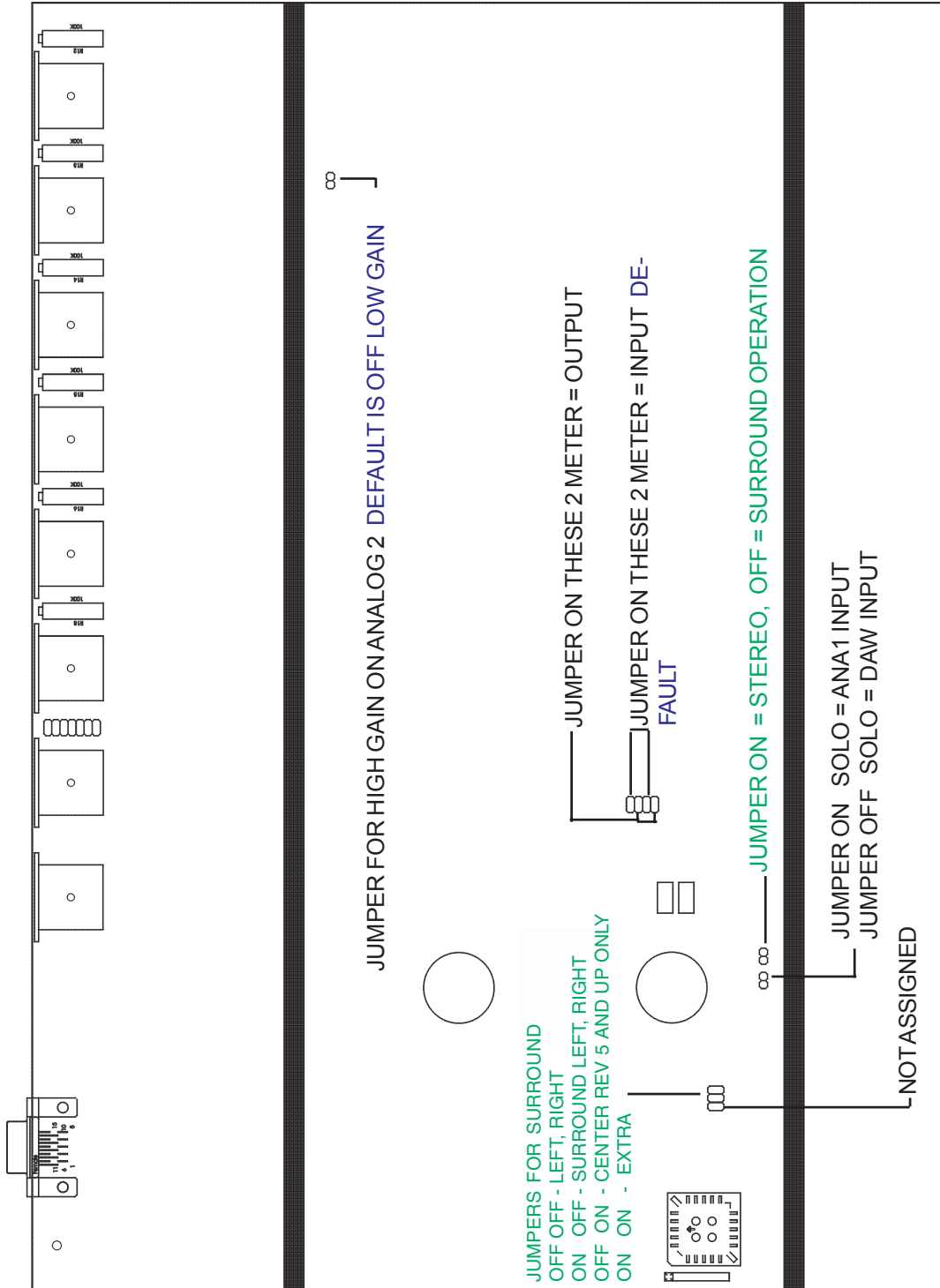

REV 5 pcb

Do not change jumpers or adjust the trim pots unless you are sure of what you are doing

## REV 5 pcb Center Channel Jumpers

Do not change jumpers or adjust the trim pots unless you are sure of what you are doing. This controls what happens with the center channel and LFE channel when in the mono mode. The settings below is for stereo operation, and in surround mode, the front and surround channels.

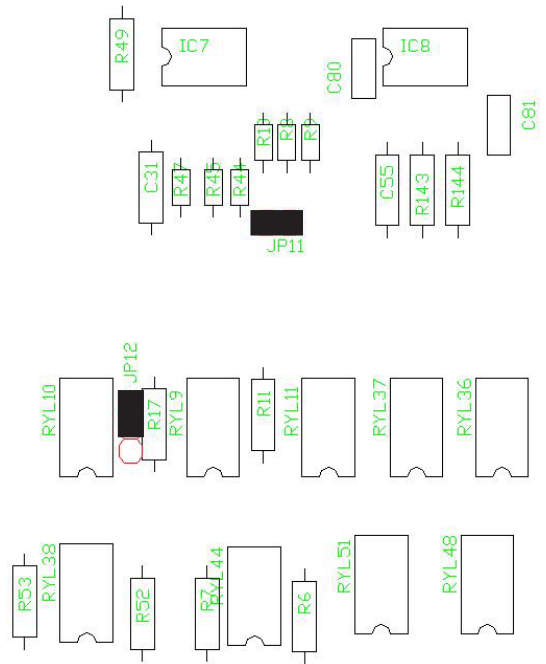

## Center Channel Surround

The settings below is for LFE and center channel operation.

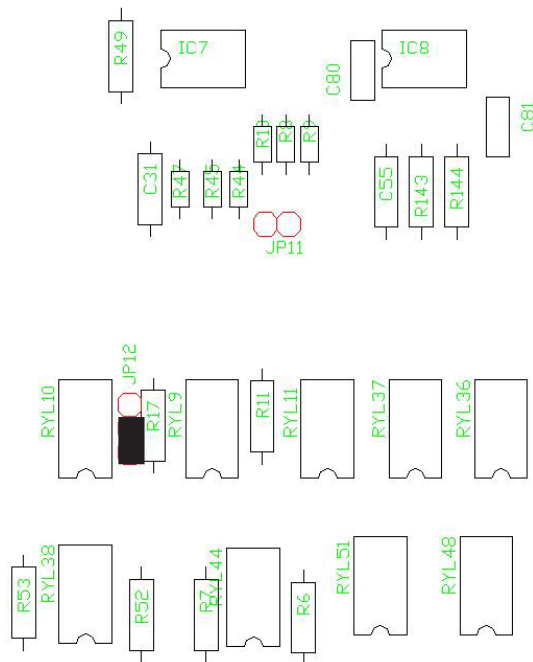

# JUMPERS POSITIONS FOR STEREO OPERATION

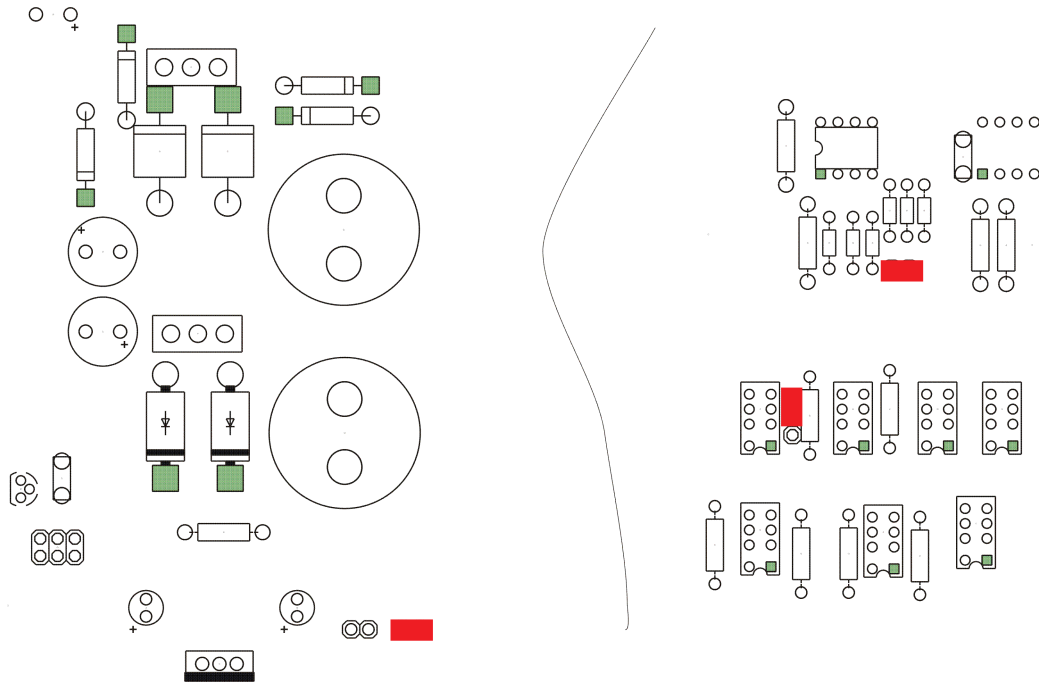

# JUMPERS POSITIONS FOR SURROUND LEFT - RIGHT FRONT

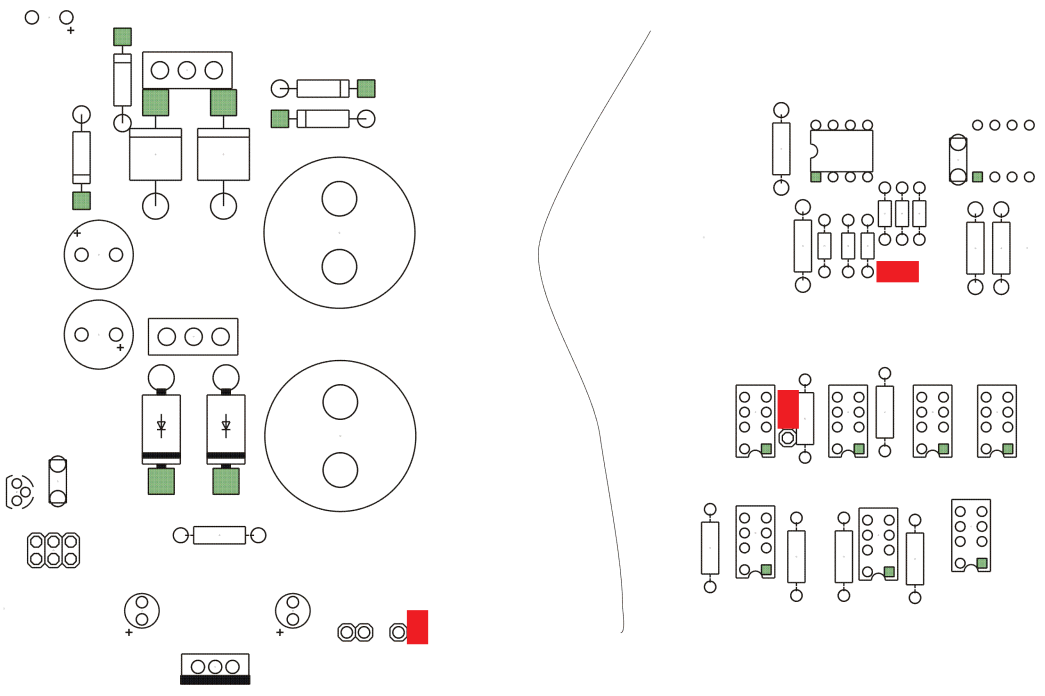

## JUMPERS POSITIONS FOR SURROUND CENTER - LFE

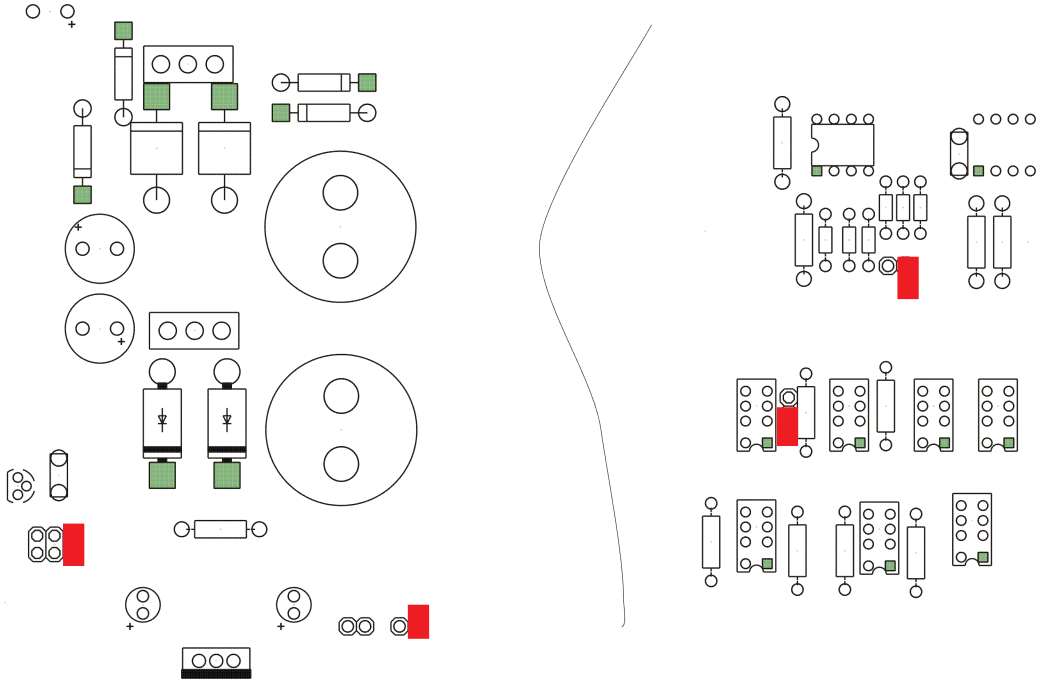

## JUMPERS POSITIONS FOR SURROUND LEFT - RIGHT SURROUNDS

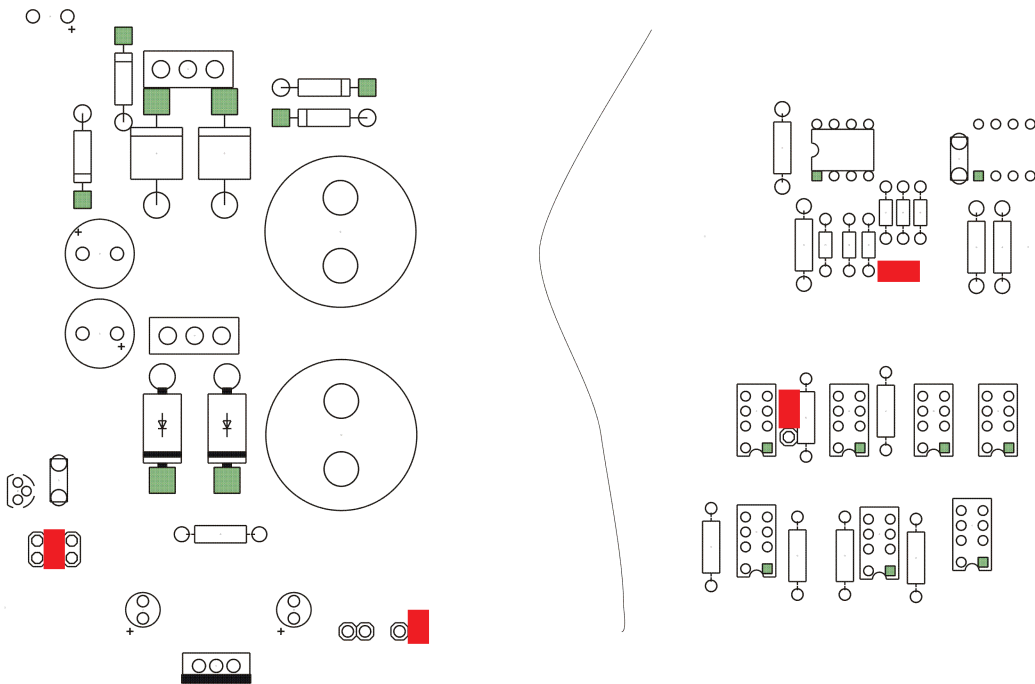

# JUMPERS POSITIONS FOR SURROUND EXTRA CHANNELS

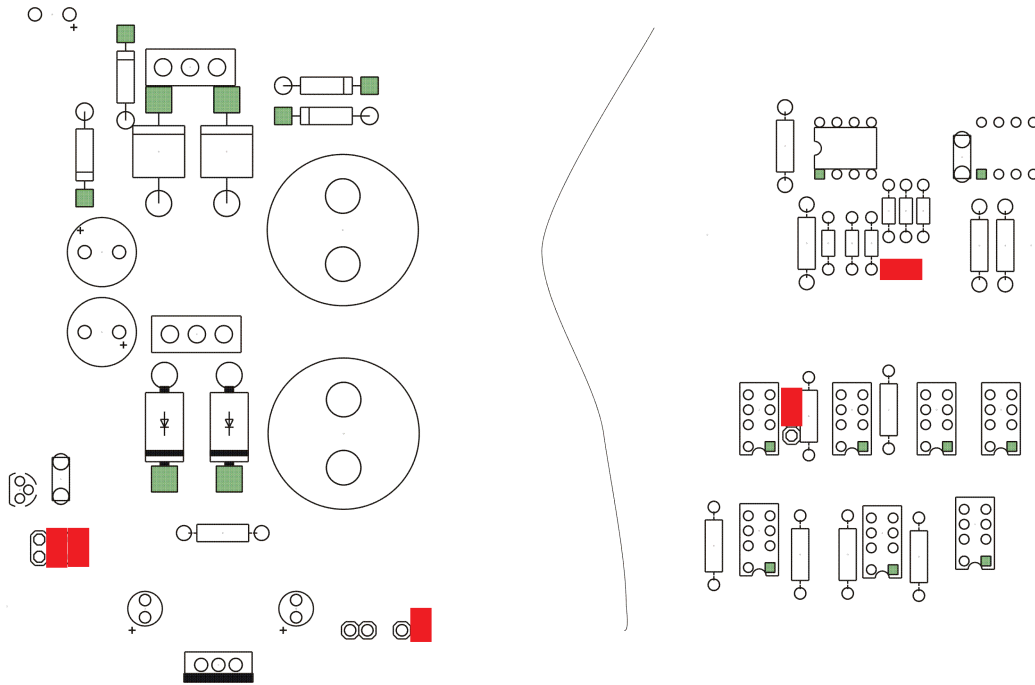

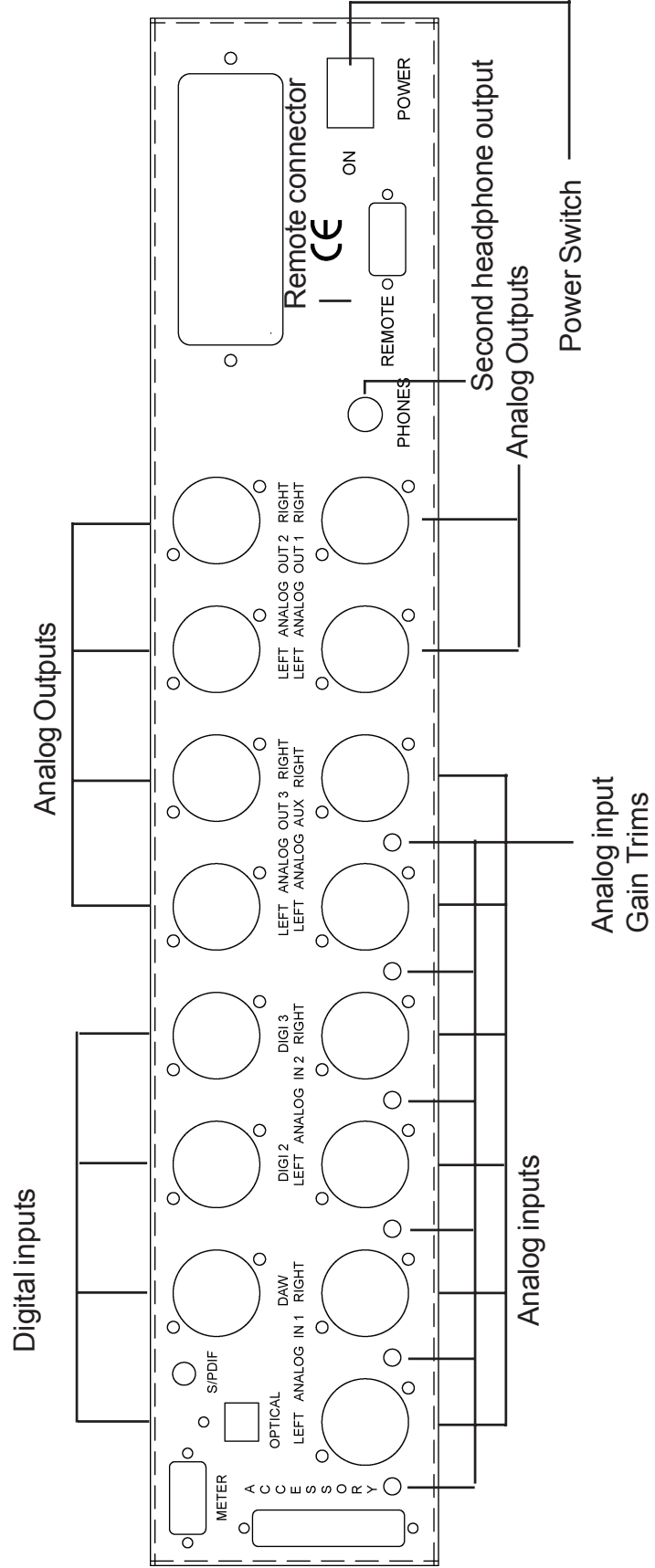

# 5.1 INTERCONNECT

link cable

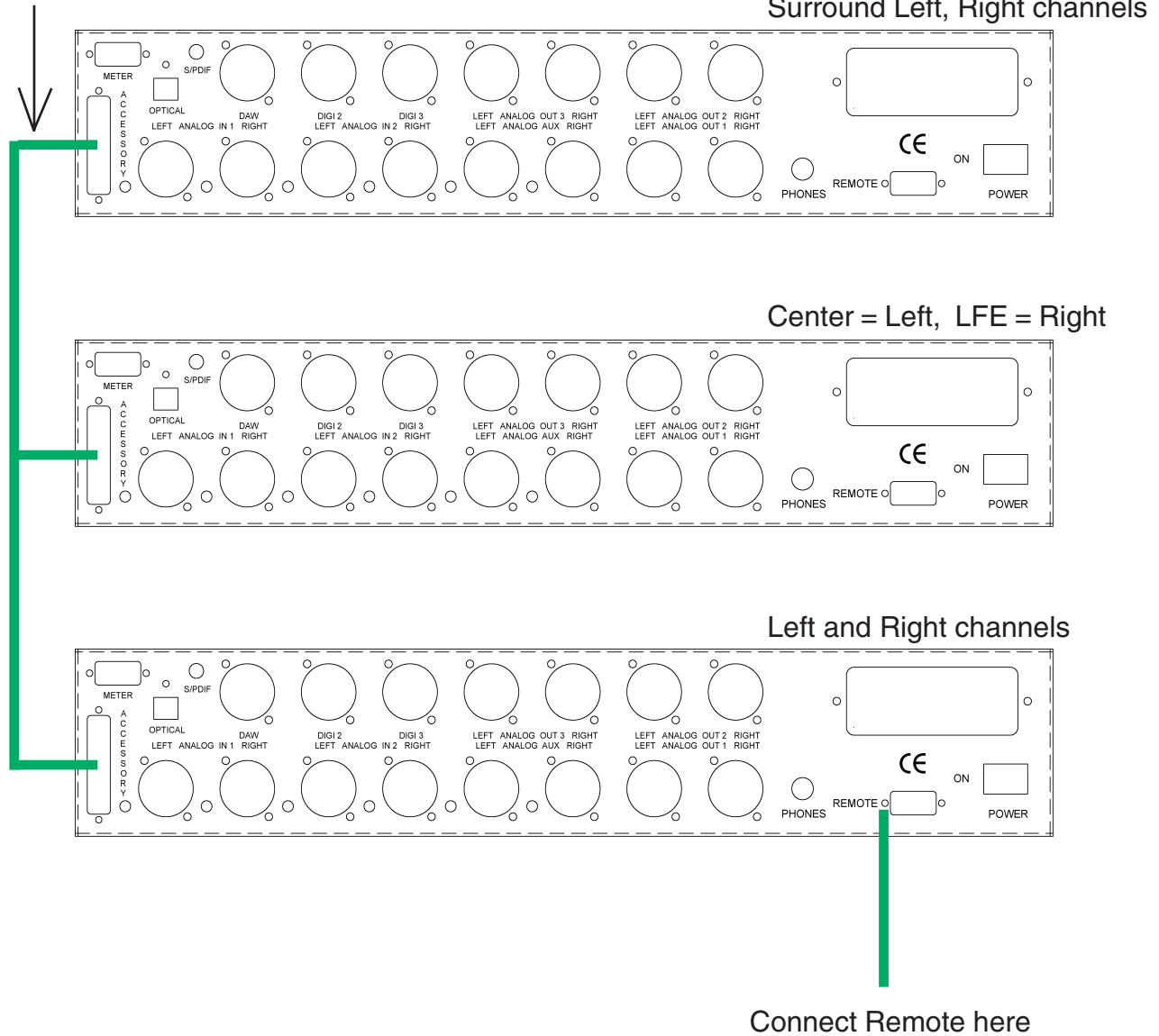

When powering the system up. If they are not all powered at the same time, the audio box with the remote connected to it must be powered on last. If any of the units are not powered the remote will not work correctly.

The internal jumpers must be set correctly. See the page with the jumper settings

# STEREO INTERCONNECT

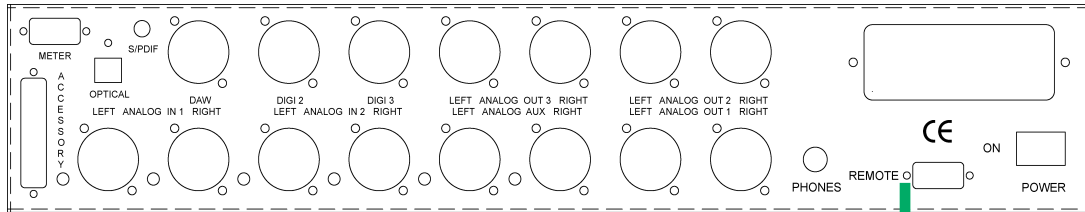

Connect Remote here

The internal jumpers must be set correctly. See the page with the jumper settings



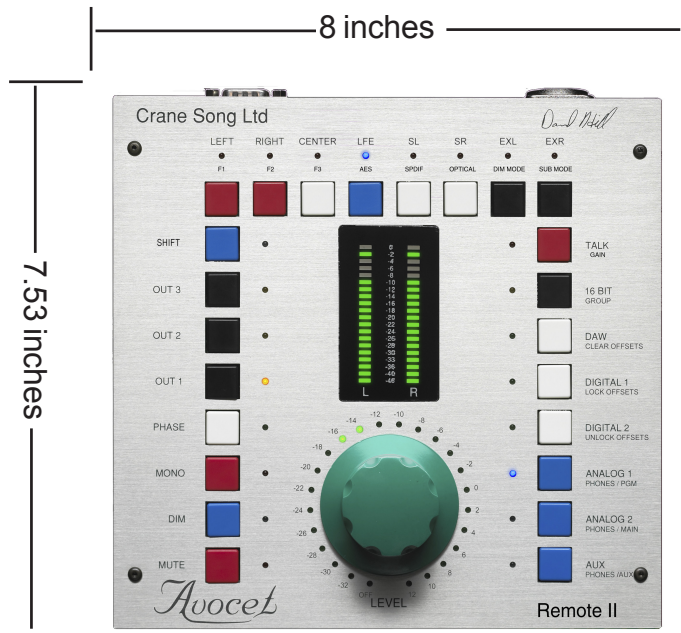

Depth not counting the knob is 1.62 inches

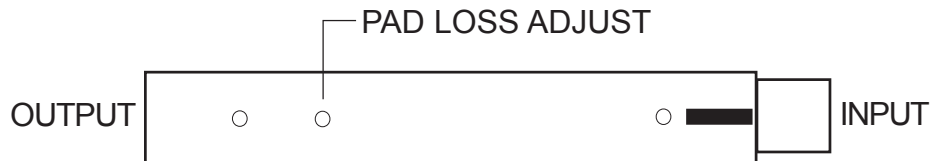

### XLR OUTPUT PAD

This is an adjustable pad for use with amplifiers or powered monitors that have no gain control. The pad has a range of 6 to 20 db of loss. It is preset to 10 db

## ACCESSORY CONNECTOR

1	Right Channel Source Output
2	gnd
3	gnd
4	talk mic output - When talk button is pushed (Mic Output)
5	Right phones out (Line level phone bus)
6	Left phones out (Line level phone bus)
7	gnd / ground
8	data I/O do not connect
9	gnd
10	gnd
11	gnd
12	Surround mono input 6
13	Surround mono input 5
14	Left Channel Source Output
15	mono out
16	talk command in - enable by tying to gnd
17	mute+
18	mute-, solo-
19	solo+
20	used in surround wiring from left-right to center channel
21	gnd
22	Surround mono input 1
23	Surround mono input 2
24	Surround mono input 3
25	Surround mono input 4

To use the external mute or solo inputs 5 to 15 volts needs to be applied to the control input lines. Polarity must be followed. These inputs are optical isolated.

The mute control is push on - push off, the talk input is also push on - push off or latching. The solo switching remains in the soloed state as long as the control voltage is applied. A jumper is provided on the main pcb that selects either the solo is the DAW or ANA1 input as the solo input.

All audio signals are unbalanced

Starting with the rev5 pcb the low connection for mute and solo has changed

See the section on headphone setup and the external wiring connections.

## Revision History

### Rev3 main pcb

### Non Surround Remote

This version will not upgrade to surround operation. New everything is required. This version has a db15 connector accessory on it's back all others have a db 25 pin connector  
This is units with serial numbers to A682840

### Rev4 main pcb

### Non Surround Remote

The Rev 4 main boards will work for front or surround channels only. This version should have 2 relays changed, it also requires a circuit modification to allow operation of the surround channel select buttons and the firmware updated for surround operation. The D/A converter will need to be upgraded to the Rev 6 D/A or later. In surround operation all the D/A's must be the same. Surround operation is then enables by installing the proper jumpers to configure the system

### Rev4 main pcb

### Surround Remote

The Rev 4 main boards will work for front or surround channels only. This version should have 2 relays changed and the firmware updated for surround operation. The D/A converter should also be checked for the Rev 6 D/A or later. In surround operation all the D/A's must be the same. Surround operation is then enables by installing the proper jumpers to configure the system  
This is units with serial numbers starting with A682881

### Rev5 main pcb

### Surround Remote

This version is required for center channel and LFE operation. The Rev 4 main boards will work for front or surround channels only. This version is shipping with the latest firmware and the latest D/A converter, Rev 6 D/A or later and is ready for surround operation by selection the proper jumpers to configure the system. The Accessory connector has a small pin out change from the rev 4 pcb. This is units starting with serial numbers A682941.

## Firmware

As of December 5, 2005 the firmware revesion that is being shipped has a blue dot on the remote and on the main unit. This firmware will not work correctlly with non blue dot firmware. There will be a firmware update in early 2006 for the non surround remotes that will allow some additional operations. Starting with the rev 4 main unit and with either the surround remote on the rev 4 pcb of the non surround remote, an upgrade in firmware will allow the remote inputs on the accessory connector to change the display on the remote when activated.

## D/A Converter

Starting with Sn A682890 we switched to a new SRC in the D/A converter. This D/A is a big improvement in sound quality. This is an upgradable item. In units with serial numbers of A682840 and less it will require some soldering skills. The later units it is plugin.

## Upgrades

Upgrades are factory direct only in the US and in the rest of the world by the local Crane Song distribution company.

### **REV7 FIRMWARE, REV7 D/A**

Starting with the rev 7 D/A board rev 7 firm ware is installed in both the main unit and the remote. **both units must contain the same rev.**

If a rev4 or later system has this firmware installed it should be fine.

In other words rev4 and later main boards with the surround remote will run rev7 firmware

The remote must be a surround version

In order to upgrade to the rev7 D/A

the wrap need to change, the digital out requires an extra hole.

This D/A is in units starting with Sn. A683041. The rev7 D/A has the same time delay as as the rev6 and later D/A so they can be mixed in a surround system.

However only rev7 and later has the metering digital output.

## THE CHANGES

1. Output #3 can work in parallel with outputs 1 or 2. This is for those who need only 2 outputs and have the desire to turn a sub woofer on or off, the OUT 3 button can be programmed to allow this type of operation. Note that when setting up the type of speaker system, stereo or surround, the system switches to non sub woofer mode. You will then need to reset this mode if you desire it. At this time, there is not any writing on the front panel for this function

2. The remote talk input is now non latching. This is available on the db 25 connector. The talk button on the remote will latch if pushed for less than 0.5 seconds, If it is held for more than 0.5 seconds it will be non latching. The remote input and the button on the remote can over ride each other.

3. A digital meter output has been added. This is an AES output on a DB-9 connector which also allows of meter sync in surround mode. It requires a specially made cable

# This page is being updated

Sn for REMOTE II starts with AR684189

Sn for the main unit with the new D/A start with AM684259

## 5.1 interface cable wiring diagram

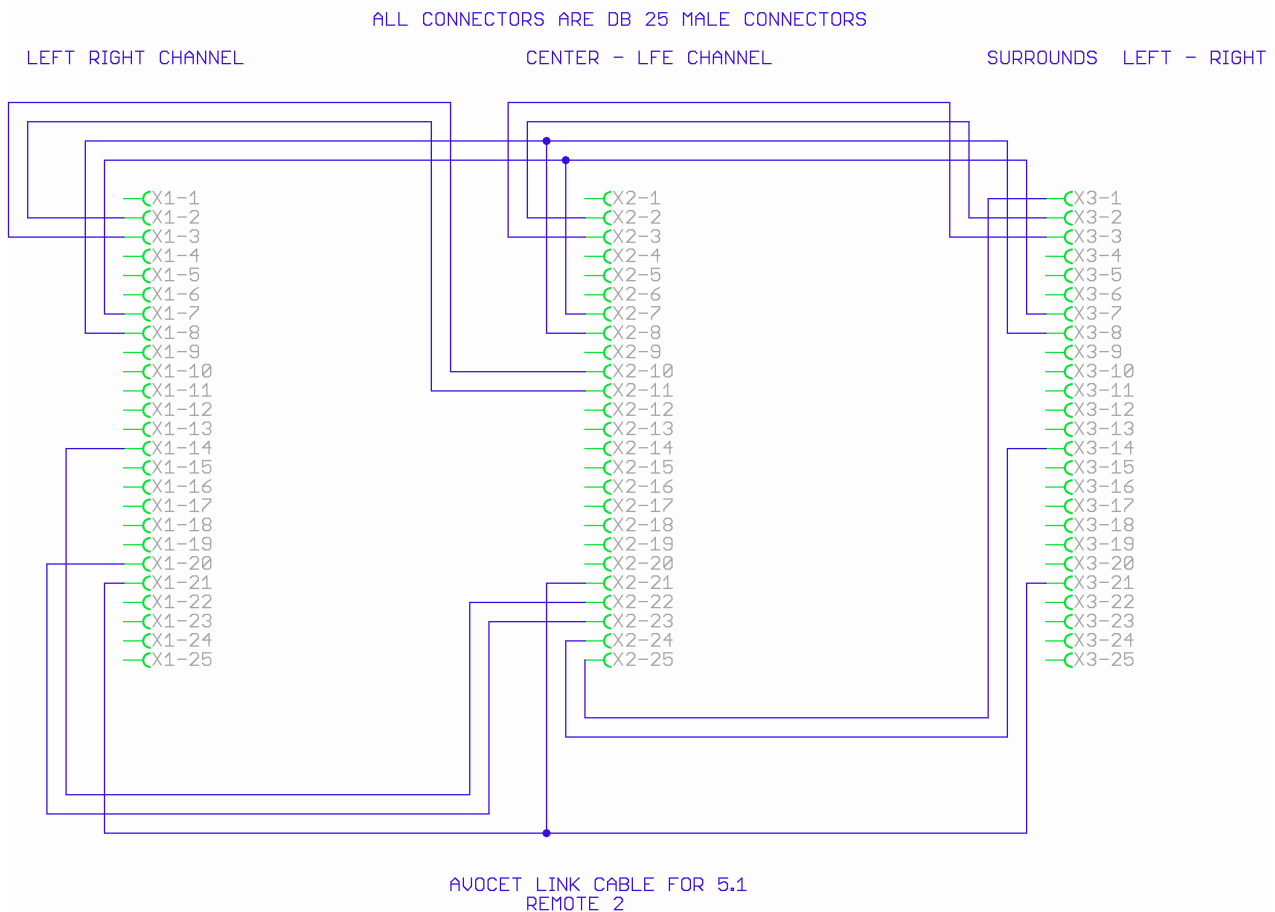

If you wish to use any the other accessory connector connections such as the talk back command input, they should be connected to the left, right audio box connector.

This is a very good starting place for setting up sub woofers. One could go farther and use a RTA and experiment and find the best place in the room for subwoofer placement.

This was written by Bob Katz, [www.digido.com](http://www.digido.com) and is used with permission

## **Accurately Set Up a Subwoofer With (Almost) No Test Instruments**

Bass frequencies are extremely important to sound reproduction. Everyone is interested in getting their bass right, but most people haven't a clue how to proceed. This article will help to settle the process of integrating an active subwoofer with an existing "satellite" system. If your room and loudspeakers are good, you'll only need two test CDs and your ears to adjust your subwoofer. If your room is not so good, or you want to refine the sound even further, then we'll discuss the best way to integrate test equipment measurements with your hearing. The simple listening test will also reveal if your room has problems and if it's time to hire an acoustician.

Let's review the basic requirements for smooth, extended bass response.

### **Conquering the Room**

Many people are proud of the "ideal dimensions" of their listening room. In general, the larger the room, the fewer audible problems with low frequency standing waves (nodes and antinodes). To get smooth and even bass requires ceilings taller than 10 feet, width greater than 12 feet, and length greater than 25 feet (30 or more for deep bass). Dimensions (including diagonals) should not be multiples of identical wavelengths, to avoid buildup at octave resonances. Of course, larger rooms may need absorption to keep the reverberation time down, but standing waves don't tend to build up awkwardly in larger rooms. It's also important to use absorption so that the decay time at low frequencies is roughly similar to that at mid and high frequencies. This is called a "neutral room."

Lightweight, flexible walls act as *diaphragmatic absorbers*, where some bass frequencies will escape out the walls, never to return. In my opinion, the ideal is a solid concrete (block) wall, but proper construction with plaster lathe, wood, and/or double sheet rock can accomplish similar results. But solid walls create problems of their own; a world-class room usually requires some absorption and/or diffusion to deal with resonances and echos. Watch out for cavities within the walls, which can cause resonances. Creating a large room with good bass response, interior acoustics, and outside isolation, is the role of a professional acoustician. This article will share some secrets in the fine tweaking of systems in good rooms; don't dream of building a room from scratch without hiring an acoustician.

### **Speaker Mounting - Spikes or Isolators?**

Soffit-mounting involves recessing loudspeakers into a cavity in the wall, with the edge of the loudspeaker flush to the wall. Soffit-mounting requires the expertise of an experienced acoustician, and is beyond the scope of this article. The main loudspeakers must be decoupled from the floor. Heavy, rigid stands should have a top no larger than the bottom of the loudspeaker to avoid diffraction (a form of comb filtering). I've had great success spiking speaker stands (using spikes, or "tiptoes") through holes in the carpet. Some authorities recommend a damping pad underneath a heavy, full

range speaker instead of spikes. Whichever mounting method, the goal is to reduce sympathetic vibrations or traveling waves in cabinets, floor and walls. The resonant frequency of the box and stand should be extremely low. Hit the box with your fist and confirm it does not have a resonant character; sweep a sine wave through the system and listen for vibrations. I've had great success with a very [thin isolator](#) between the speaker and the stand which compresses almost completely under the speaker's weight.

### **Listener position**

If you're sitting in an antinode, there's always going to be a dip at that frequency, and no amount of equalization will correct the acoustic problem.

### **Speaker position**

Ironically, solid walls aggravate the interaction of loudspeaker position and frequency response. The closer the loudspeaker to walls and especially corners, the greater the bass level. You may have the "smoothest," most accurate satellite (main) speakers in the world, but they must be positioned to avoid side wall reflections and must be far enough from all walls to reduce resonances.

### **Near Field Monitoring?**

I wouldn't master with near-field monitors, but I will mix with them. Near-field monitoring was devised to reduce the effects of adverse room acoustics, but if your room acoustics are good, then "Mid-field" or "Far-field" will provide a more accurate depth and spatial picture. There must be an obstruction-free path between the monitors and the listener. **What is the biggest impediment to good sound reproduction in a recording studio? The console.** No matter how you position the monitors, the console's surface reflects sound back to your ears, which causes *comb filtering*, the same tunnel effect you get if you put your hand in front of your face and talk into it. Or if you wear a wide-brimmed hat, which produces an irregular dip around 2 kHz. It amazes me that some engineers aren't aware of the deterioration caused by a simple hat brim! Similarly, I shudder when I see a professional loudspeaker sitting on a shelf inches back from the edge, which compromises the reproduction. The acoustic compromise of the console can only be minimized, not eliminated, by positioning the loudspeakers and console to increase the ratio of the direct to reflected path. Lou Burroughs' 3 to 1 rule can be applied to acoustic reflections as well as microphones, meaning that the reflected path to the ear should ideally be at least 3 times the distance of the direct path.

### **What about measurements?**

Can't we just measure, adjust the crossovers and speaker position for flattest response, then sit down and enjoy? Well, since no room or loudspeaker is perfect, measurements are open to interpretation, and frequency response measurements will always be full of peaks and dips, some of which are more important to the ear than others. Which of those many peaks and dips in the display are important and which ones should we ignore?

I've found the ear to be the best judge of what's important, especially in the bass region. The ear will detect there's a bass problem faster than any measurement instrument. The measurement instrument will help to pinpoint the specific problem frequencies, whether they're peaks or dips, and by supplying numbers, aid in making changes. The whole process is very frustrating, and it's inspired my search for setup and test methods that use the ear. A perfect setup still requires a multistep process: listen, measure, adjust, listen again, and repeat until satisfied, but it's possible to streamline that process. Here's a listening test for adjusting subwoofer crossovers that uses simple, readily obtainable and cheap test materials, and that's generally as precise as most more formal measurement techniques! If you're setting up a permanent system, dedicate a day to the process; even the easy doesn't come easy. Some brands of subwoofer amplifiers have all the controls or connectors you need; you may have to adapt the process described below to your particular woofer system.



## Polarity is not Phase

This is still a confusing topic, perhaps because people are too timid to say *polarity* when they mean it. The *polarity* of a loudspeaker refers to whether the driver moves outward or inward with positive-going signal, and can be corrected by a simple wire reversal. Remember that *phase* means *relative time*; phase shift is actually a time delay. The so-called *phase* switches on consoles are actually *polarity* switches, they have no effect on the time of the signal! Sometimes this is referred to as *absolute phase*, but I recommend avoiding the use of the term *phase* when you really mean *polarity*. If two loudspeakers are working together, their polarity must be the same. If they are separated by space, or if a crossover is involved, there may be a *phase* difference between them, measured in time or degrees (at a specific frequency). I have a pair of *Genesis* subwoofers with separate servo amplifiers. There are three controls on the crossover/amplifier: volume (gain), phase (from 0 to 180 degrees), and low pass crossover frequency (from 35 Hz to over 200 Hz). Notice there is no high pass adjustment. The *natural* approach to subwoofer nirvana assumes that your (small) *satellite* loudspeakers have clean, smooth response down to some bass frequency, and gradually roll off below that. It's logical to use the natural bass rolloff of the satellites as the high pass portion of the system and to avoid adding additional electronics that will affect the delicate midrange frequencies. So we use a combination of lowpass crossover adjustment and subwoofer positioning to fine-tune the system.

A good subwoofer crossover/amplifier usually provides more than one method of interconnection with the satellite system. The best is the one which has the least effect on the sound of the critical main system. I prefer not to interfere with the line level connections to the (main) power amp feeding the satellites. If your preamplifier does not have a spare pair of buffered outputs, I recommend using the speaker-level outputs of the main power amp. The *Genesis* provides high-impedance transformer-coupled balanced inputs on banana connectors designed to accept speaker-level signals. Connect the main power amp's output to the sub amp's input with simple zip cord with bananas on each end. No real current is being drawn, so wire gauge does not have to be heavy. Double-bananas make it easy to reverse the polarity of the subwoofer, a critical part of the test procedure. Some subwoofers use a 12 dB/octave crossover, others 18 or more. Interestingly, for reasons we will not discuss here, a 12 dB crossover slope requires woofers that are wired out of polarity with the main system. My subs use a 12 dB slope, but to make it easy on the mindless, the internal connections are reversed, and you're supposed to connect "hot to hot" between the main power amplifier and woofer amplifier. Leave nothing to doubt—we must confirm the correct polarity.

You have to sit in the "sweet spot" for the listening evaluation. If your subwoofers have an integrated amplifier, you'll need a cooperative friend to make adjustments. Since the *Genesis* amplifier is physically separate, I was able to move the subwoofer amplifiers to the floor in front of the sweet spot, and make my own adjustments. Here are the two test CDs:

1. The Mix Reference Disc, Deluxe Edition, MRD2A, available from [Music Books Plus](#), or any source of 1/3 octave filtered pink noise. Track 71 contains full bandwidth pink noise, and tracks 11 through 41 use multi frequencies in 1/3 octave bands.
2. Rebecca Pidgeon, *The Raven*, Chesky JD115, available at record stores, high-end stereo stores, or from [Chesky Records](#).

I recorded Rebecca's disc in 1994. Track 12 is *Spanish Harlem*, which has a slow, deliberate acoustic bass part that makes it easy to identify notes that "stick out" too far and covers the major portion of the bass spectrum. This record has never failed to reveal the anomalies of different rooms and loudspeakers in several years of use as a musical reference. The ear is better with instant comparisons than absolute judgments, and this test relies on our ear's ability to make comparisons.

All musical instruments and transducers produce harmonics as well as fundamentals. To the best of our ability to discriminate, we will be concentrating on the fundamental tones in this piece of music. If your loudspeakers have significant harmonic distortion, they can complicate or confuse the test. Many studio loudspeakers are designed for high power handling at the expense of tonal accuracy or distortion. This test is not for them. If you want accurate bass, it's time to replace the loudspeakers and probably hire an acoustician with a distortion analyzer.

Start by evaluating the satellite system with the subs turned off. Listen to the bass at a moderate level equal to or slightly louder than the natural level of an acoustic bass. Listen for harmonic distortion: if it doesn't sound like a "transparent" acoustic bass, fix the problem with the satellites, first. Listen for uneven notes. If the lower note(s) of the scale are successively softer in level than the higher notes, then you have a perfect candidate for a subwoofer. If intermediate bass notes are weak or strong (uneven bass), the satellite loudspeakers may be too close to the corners, in a node or antinode, the listening position may be in a standing wave, or the satellites themselves poorly designed. It may be time to bring in an acoustician. But if the satellite bass is even, you can move on to the next step, adjusting the subwoofers.

*Spanish Harlem*, in the key of G, uses the classic 1, 4, 5 progression. Here are the frequencies of the fundamental notes of the bass. If your loudspeaker has sufficiently low harmonic distortion, it will not affect your judgment of the power of the bass notes, which are already affected by the natural harmonics of the instrument.

49 62 73 65 82 98 73 93 110

As you can see, this covers most of the critical bass range. If the lowest note(s) is weaker than the rest, then you are a candidate for a subwoofer. My satellites behave in the classic manner, with the lowest note (G, 49Hz) slightly low in level, but the rest fall in a balanced line. I've been in small rooms where one or more of the intermediate notes are emphasized or weak, which suggests standing wave problems. Repositioning the satellites may help. Avoid equalization, which is a nasty band aid...proper acoustic room treatment is the cure. You could conceivably add a subwoofer out of phase at the frequencies in question, but that's a technique that should remain confidential between you and your analyst. Fix the acoustic problems first and you'll be happier.

If your satellite system passed the initial examination, next step is to decide on a starting (approximate) subwoofer location. A satellite-subwoofer system has tremendous flexibility, offering in theory the best of two worlds. The satellites can be placed on rigid stands at ear level, far from corners and side walls, reducing floor and wall reflections and comb-filtering in the midband. And the subs can be placed on the floor, in the position that gives the most satisfactory bass response, integrated with the satellites. If you only have one (mono) subwoofer, start by placing it in the middle between the stereo speakers. Contrary to popular belief, stereo subwoofers are important, they can improve the sense of "envelopment", the concert hall realism that bass waves are passing by you. Authorities are split on the issue whether a mono or stereo subwoofer setup is more forgiving of room modes. I prefer the sound of stereo subwoofers. A complete discussion of how to place the satellites would require another article, but let's start by saying that you may have to deal with reflections from the side walls by placing absorbers in critical locations. Consider consulting a competent acoustician.

Assuming your satellite system passes the listening test, it's time to find the right crossover frequency, phase and woofer amplitude that will just supplement the lower notes of the scale. Start by placing the subwoofers next to and slightly in front of the satellites. First we must determine the proper polarity for the subwoofers. If your system uses XLR input connectors, build a polarity reversing adapter for this part of the test. This is easier with only one channel playing. Put on the **MRCDD** with full bandwidth pink noise, at a moderate level (70-80 dB SPL). Adjust the crossover to its highest frequency, the phase to 0, and turn up the subwoofer gain until you're sure you can hear the woofer's

contribution. Reverse the polarity of the sub. The polarity which produces the loudest bass is the *correct polarity*. Mark it on the plugs, and don't forget it!

Next comes an iterative process ("lather, rinse, repeat until clean"). Here's a summary of the four-steps: (1, 2, & 3) Using filtered pink noise, we'll determine the precise phase, amplitude and crossover dial position for *any one crossover frequency*. (4) Then we'll put Rebecca back on and see if all the bass notes now sound equally loud. If not equally loud, then we'll go back to the filtered pink noise and try a different crossover frequency. We keep repeating this test sequence until the bottom note(s) has been made "even" without affecting the others. With practice you can do this in less than half an hour. Adjust each subwoofer individually, playing one channel at a time.

And now in detail:

### **1) Crossover frequency (lowpass)**

Play filtered pink noise (or the Mix CD's multifrequencies) at your best guess of crossover frequency, say 63 or 80 Hz. Notice that the signal has a *pitch center, or dominant pitch quality*. If the subwoofer is misadjusted, adding the sub to the satellites will slide the pitch center of the satellite's signal. Reverse the sub's polarity (set it to *incorrect polarity*). With the sub gain at a medium level, start at the lowest frequency, and raise the frequency until you hear the dominant pitch begin to rise (literally, the center "note" of the pink noise appears to go sharp, to use musical terms). Back it off slightly (to a point just below where the pitch is affected), and you have correctly set the crossover to this frequency.

Recheck your setting. That's it.

### **2) Phase**

The sub should always be on a line with or slightly in front of the satellite. With the woofer a moderate amount in front of the satellites, the phase will generally need to be set something greater than 0 degrees. Return the sub(s) to *the correct polarity*. Play the same frequency of filtered noise and increase the amount of "phase" until you hear the dominant pitch rise. Back it off slightly, recheck your setting, and that's it

### **3) Amplitude**

The subwoofer's settings are exactly correct when its amplitude is identical to the satellite's at the crossover frequency. The subwoofer gain is the easiest to get right because there will be a clear center point, just like focusing a camera. Play the filtered noise, and discover that the pitch is only correct at a certain gain, above which the pitch goes up (sharp), and slightly below which it goes down (flat). "Focus" the gain for the center pitch, which will match the pitch of the satellites without the sub. Recheck your work by disconnecting and reconnecting the sub. The pitch should not change when you reconnect the sub, otherwise the gain is wrong. To be extremely precise, increase the gain in tiny increments until you find the point where the pitch rises when the sub is connected, then back the gain off by the last increment. This process is extremely sensitive.

### **4) Rebecca**

Play *Spanish Harlem* again. If all the levels of the bass notes are even, you're finished with steps 1-4. If you hear a rise in level below some low note, then the crossover frequency is too high and vice versa. Do not attempt to fix the problem with the subwoofer gain, because that has been calibrated by this procedure, which leaves nothing in doubt except the choice of crossover frequency. Go back to step one and try again. Once all the notes are even, your crossover is perfectly adjusted. Write that frequency down. Then, for complete confidence, check the nearest frequency above and below (go back through steps 1-4), proving you made the right choice. This piece of test music is sufficiently useful that there will be a clear difference between each 1/3 octave frequency choice and it will be comparatively easy to determine the winner. The trick is not to rely on our faulty acoustic memory, but on the ear's ability to make relative comparisons.

## More Refinement

### Fine tuning the stereo separation (space between the woofers)

If you have stereo subwoofers, their left-right separation must be adjusted. Play *Spanish Harlem*. Listen to the sound of the bass with the subs off. It should be perfectly centered as a phantom image and its apparent distance from the listener should subtend a line between the satellites. If it is not perfectly centered or its image is vague, the satellites are too far apart. Now add the subwoofers. The bass should not move forward or backward, and its image should not get wider or vaguer. Adjust the physical separation of the subwoofers until the bass image width is not disturbed when they are turned on. This “integrates” the system. Go back to step one, recheck the amplitude and phase settings for the new woofer position. Everything is now spot on.

Congratulations, you’ve just aligned a world-class reproduction system! A subwoofer should not call attention to itself, either by location or amplitude. When you play music, the combination of the sub and mains will sound like a single, seamless source.

Now, after logging your settings, sit back, listen and enjoy. You’ve earned the time off. Don’t let anyone touch those hard-earned adjustments, for you can be confident that they are about as good as they’re going to get. Play several of your favorite recordings, and listen to the bass. The bass on the best recordings will be acceptable on your reference system; the worst recordings will have too much or too little bass. Now you can be reasonably sure the problem is in the recording, not your room or woofers. What a nice feeling!

### How The Pitch Detection Method Works

The 1/3 octave pink noise signal (or the multitone test signal) contains a narrow band of frequencies, whose dominant level is at the center of the band. Thus, you perceive a “pitch” to the signal. When you add a second loudspeaker driver (the subwoofer) driven by the same signal, if the woofer’s output does not exactly match the level and distribution of frequencies produced by the main loudspeaker, there will be a shift in the dominance of the multifrequencies, either towards the high end of the band or the low end, perceived as a pitch shift. When the two signals are well-matched in level, frequency distribution and phase, you will hear a delicate increase in level, but no change in pitch. By simple comparative listening, taking the woofer in and out of the circuit, you have confirmed that your drivers are matched at the crossover frequency, and that the wavefronts of your main speakers and subs are aligned at the critical crossover frequency.

Of course, we’re making certain assumptions...that:

- your satellite system is well designed, linear and rolls off below some defined frequency.
- your subwoofer system is linear and rolls off above some defined frequency.
- the slopes of the two rolloffs are compatible and will integrate.

Your degree of success depends on how closely the two systems meet those requirements.

## What To Do When the Results are Less Than Perfect

When interpreting *Spanish Harlem*, don't get too hung up on little "dips" in level. Dips are less objectionable to the ear than peaks. First, attack problems with resonant notes and then look at the dips. Everything may not be rosy the first time around. Supposing that the subwoofer helped the bottom note(s), which means the crossover is at the right frequency, but some upper note in the progression has been affected. This means the subwoofer position is not optimized, or the subwoofer has some frequency response anomaly. As the sub is moved towards the room corners, the low bass response goes up, previous dips become peaks. There's cancellation/reinforcement between the subs and the satellites, which changes complexly as the sub is moved. Thus, adjusting the subwoofer position is a powerful method to even out the bass, but this type of trial and error is too complicated without test equipment. You could slide the woofer slightly, adjust the crossover as above, listen, move it again, readjust, and listen, but our acoustic memory is too short to tell when we've hit the perfect spot.

## Advanced Techniques

### Integrating the Instruments with the Ears

Here's where it gets complicated. If you are having problems with uneven bass, we can no longer rely strictly on our ears. If you're comfortable with measurement instruments, then let's proceed. First, listen to Rebecca and mark down the problem frequency or frequencies, either peaks or dips. You'll use that knowledge when you bring in the big guns, the 1/3 octave analyser. The good thing is that Rebecca has already told you where the problems are, so you'll know how to separate the forest from the trees in the 1/3 octave display. I used *Spectrafoo* (an excellent analysis program for the Mac) in transfer function mode with wide band pink noise into both satellites and subs (one channel at a time). *Spectrafoo* time aligns the stimulus and response, which helps to separate direct from reflected sound, more accurately representing what the ear hears. *Spectrafoo* revealed a rising response in my room below 40 Hz, and more important, a little dip in the combined response circa 63 Hz which corresponded with my perception that note was perhaps a little weak. By moving the sub around very slightly and watching the display, I was able to exchange the weakness against the surplus without aggravating any other peaks.

The strength of this method is we're continuously integrating our powerful (almost objective) listening judgments with the "over-powerful" analysis tool. We're using the analyser for general trends, not absolute amplitudes; that's what I mean by separating the forest from the trees. The position of the test microphone should be in the exact listening position. Wear earplugs to keep your ears fresh when you're not required to listen. After moving the woofer, don't forget to readjust the crossover gain and phase with our listening technique.

If all goes well, *Spanish Harlem* will be even better adjusted and we can rest assured that our system is **really really tweaked**. Now sit back and enjoy. Oops, your work is never done. Now that you've adjusted your system, I'll let you in on one more secret: Servo amplifiers have internal adjustments that affect woofer damping, make the bass "tighter" or "looser." but that's another story.

## **Acknowledgments:**

Jon Marovskis of Janis Subwoofers introduced me to the concept of a pitch detection technique many years ago. This article refines and expands on his original idea.

Many thanks to Dave Moulton for insightful technical and editorial comments.

Also, thanks for manuscript review and suggestions by Johnson Knowles of the Russ Berger Design Group, Eric Bamberg, Greg Simmons and Steven W. Desper.

---

Acoustician Johnson Knowles suggests a viscoelastic polymer pad material like EAR Isodamp C1002 or C1000. The internal damping characteristics of the viscoelastics are exceptionally effective as a speaker to stand interface material.

U.S. Consultant Steve Desper recommends STIK-TAK by Devcon Corporation, available at your local hardware store. It's a cheap solution and works well. Australian Greg Simmons has found a similar product—marketed as *Blue Tak*: “Use enough of it relative to the weight of your speakers. For a small monitor weighing just over 20kg, I used four balls about 15mm in diameter (one under each corner). With 20kg on top of them, these balls squashed down to about 4mm or 5mm thickness, and held the monitor very firmly.”

These HTML documents are Copyright 1999-2003 Digital Domain, Inc. All rights reserved. The following are trademarks of Digital Domain, Inc.: Digital Domain, Digi-nary. These documents may not be reproduced in any manner without the permission of the copyright owner. We invite the audio and music community to link to this web site, which will be periodically revised. Last revised December 2003.

## HEADPHONE SYSTEM

### Method 1 Seperate cue mix

A external cue mix may be feed into the AUX analog input, the internal headphone amp system can be used

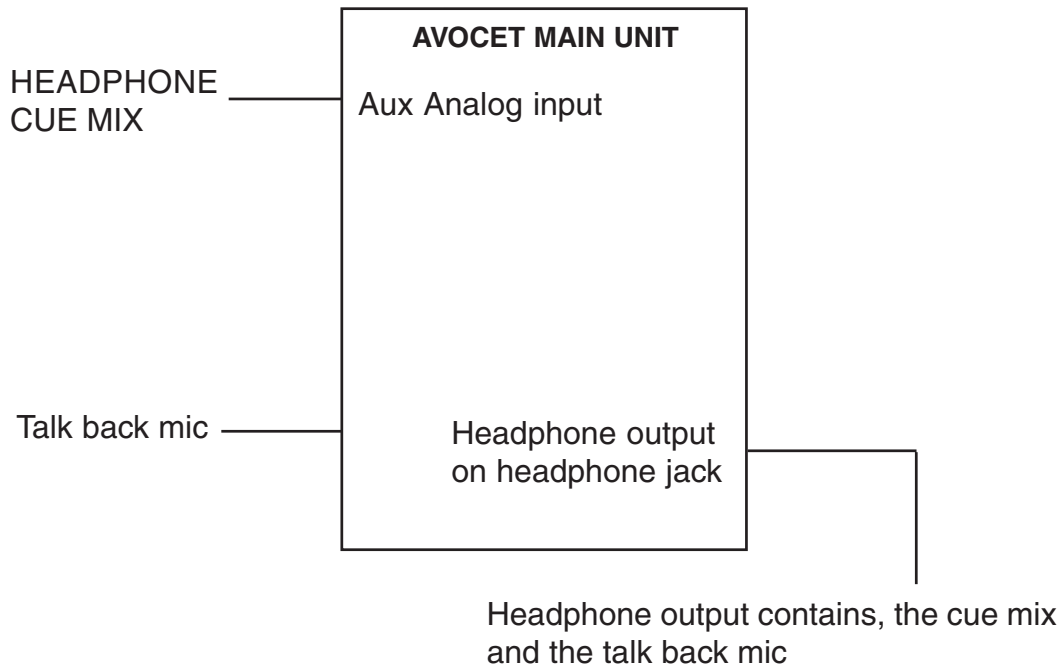

To set this up select the PHONES / SHIFT button. When in this mode select the "phones / aux" button (this is the phones source), then adjust the phones level with the big knob. After setting the level leave the PHONES / SHIFT mode by touching its button a second time. The phones level will not be effected by the main level.

The internal headphone amp is capable of driving multiple headphones and in many cases an external headphone amplifier is not needed.

Method 2 Seperate cue mix The phones are not effected by the main level

The main audio source is feed to the internal headphone amp.

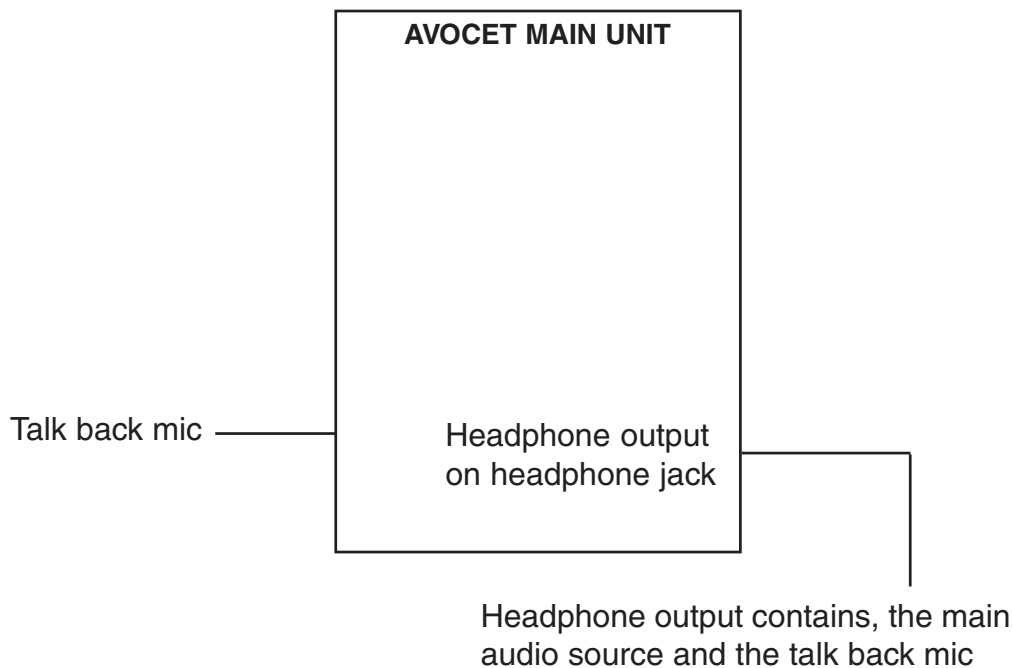

To set this up select the PHONES / SHIFT button. When in this mode select the "phones / main" (this is the phones source), then adjust the phones level with the big knob. After setting the level leave the PHONES / SHIFT mode by touching its button a second time.

In ths mode the headphones audio will always be what the main audio is. Every one will hear the same mix. The headphone level will not change when the main level knob is changed and the headphones will not be effected by the phase, dim, mono or mute buttons.



Method 3 Separate cue mix The phones are effected by the main level

The main audio source is feed to the internal headphone amp.

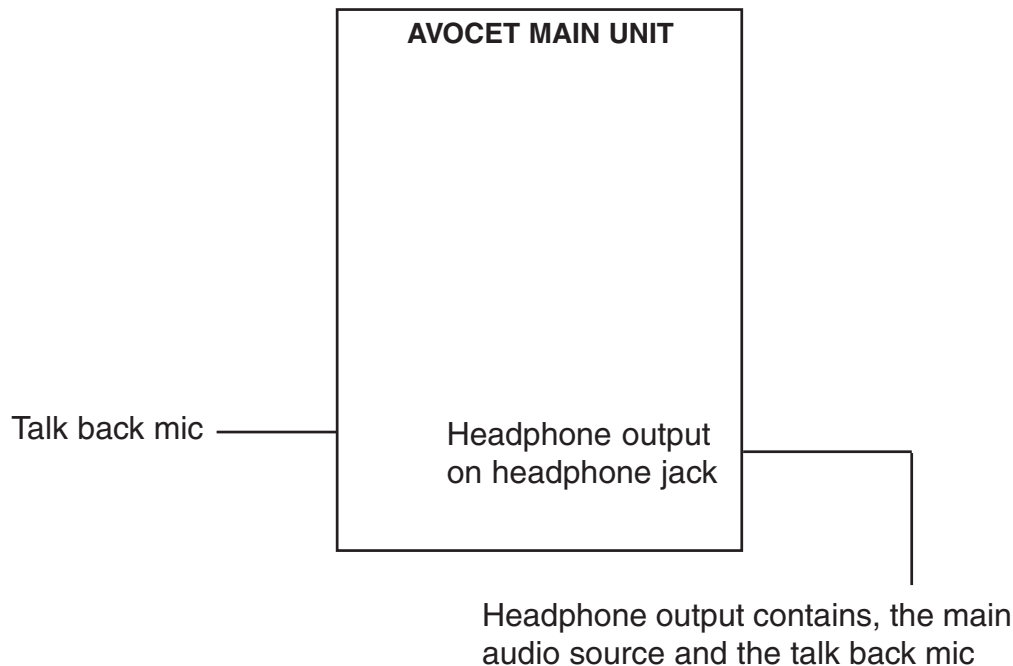

To set this up select the PHONES / SHIFT button. When in this mode select the "phones / pgm" (this is the phones source), then adjust the phones level with the big knob. After setting the level leave the PHONES / SHIFT mode by touching its button a second time.

In ths mode the headphones audio will always be what the main audio is. Every one will hear the same mix. The headphone level will change when the main level knob is changed and the headphones will be effected by the phase, dim, mono buttons. The mute button will not effect the phones. Mute is a speaker function.

## USING AN EXTERNAL HEADPHONE AMPLIFIER

The audio source will be what ever has been defined during setup, see the pervious three pages.

The headphone jack will still operate

The external amplifier and the headphone jack will have the same audio and talk back mic singals.

The external output level is also changed when changing the internal phones level.

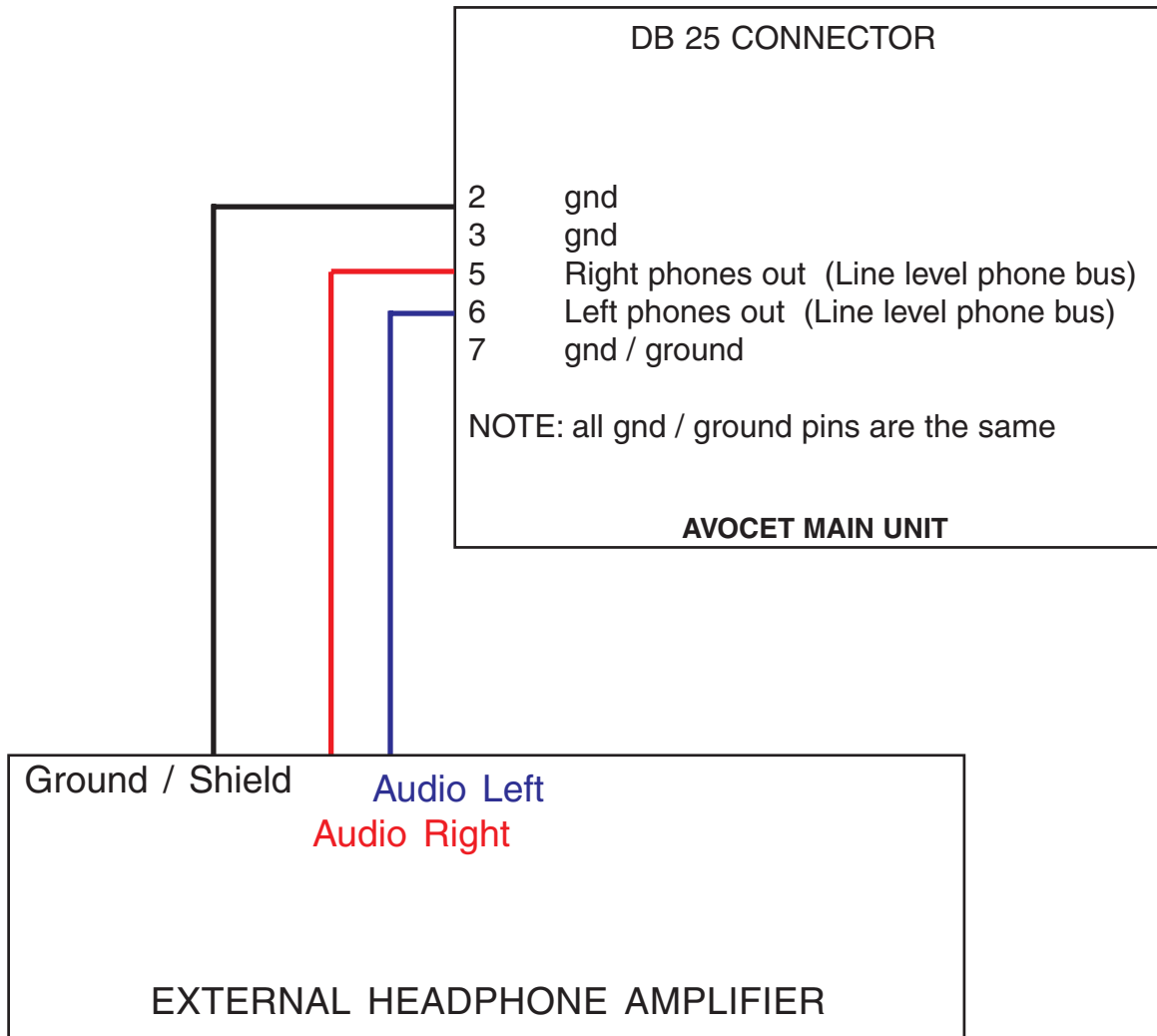

## EXTERNAL AUDIO OUTPUT

The audio source will be the selected input  
It is not effected by the gain control or other functions

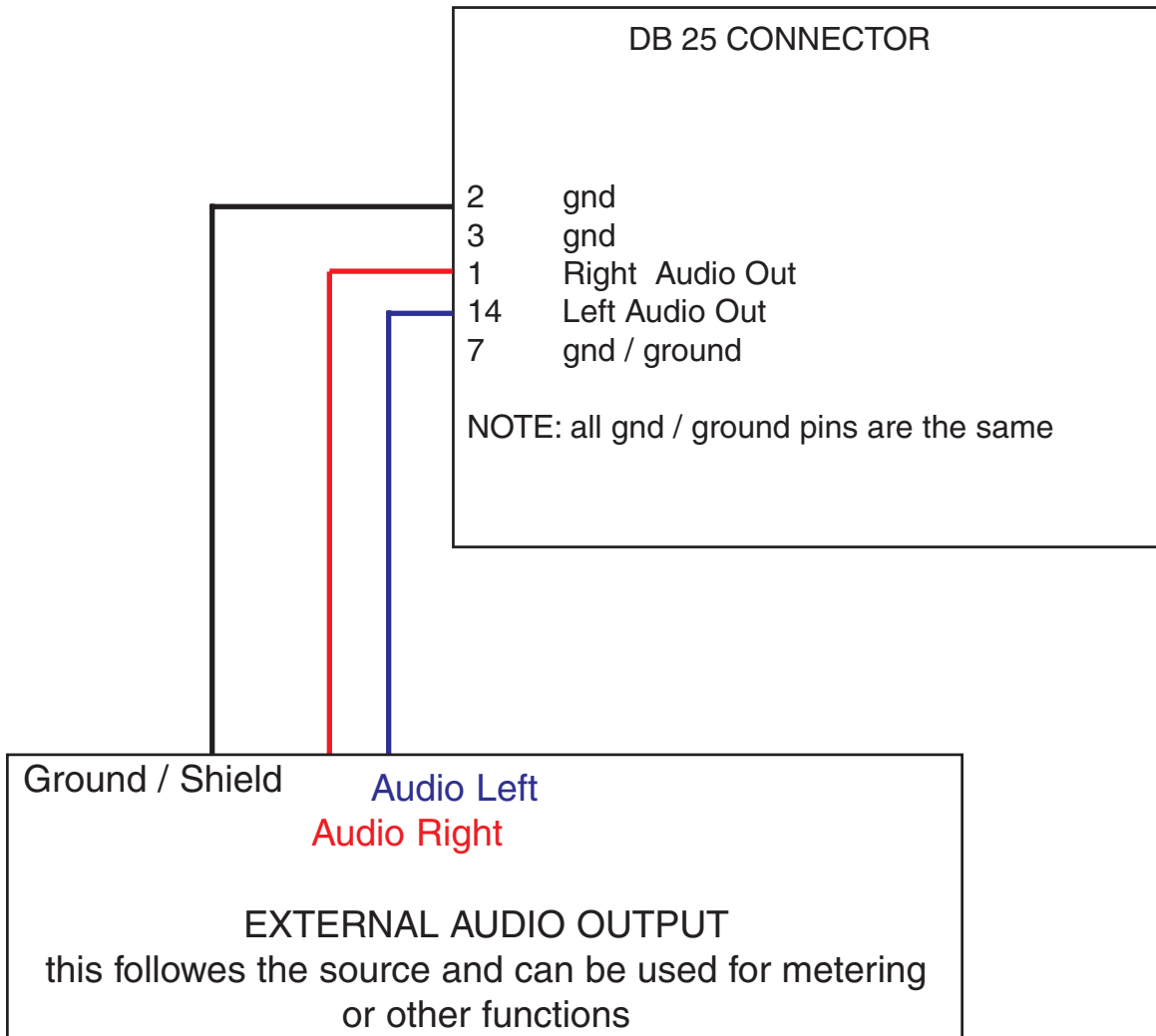

## SENDING THE TALK MIC SIGNAL TO AN EXTERNAL HEADPHONE SYSTEM

The talk mic signal can be sent to an external headphone system as shown. The mic signal will be present only when the talk mic button is on.

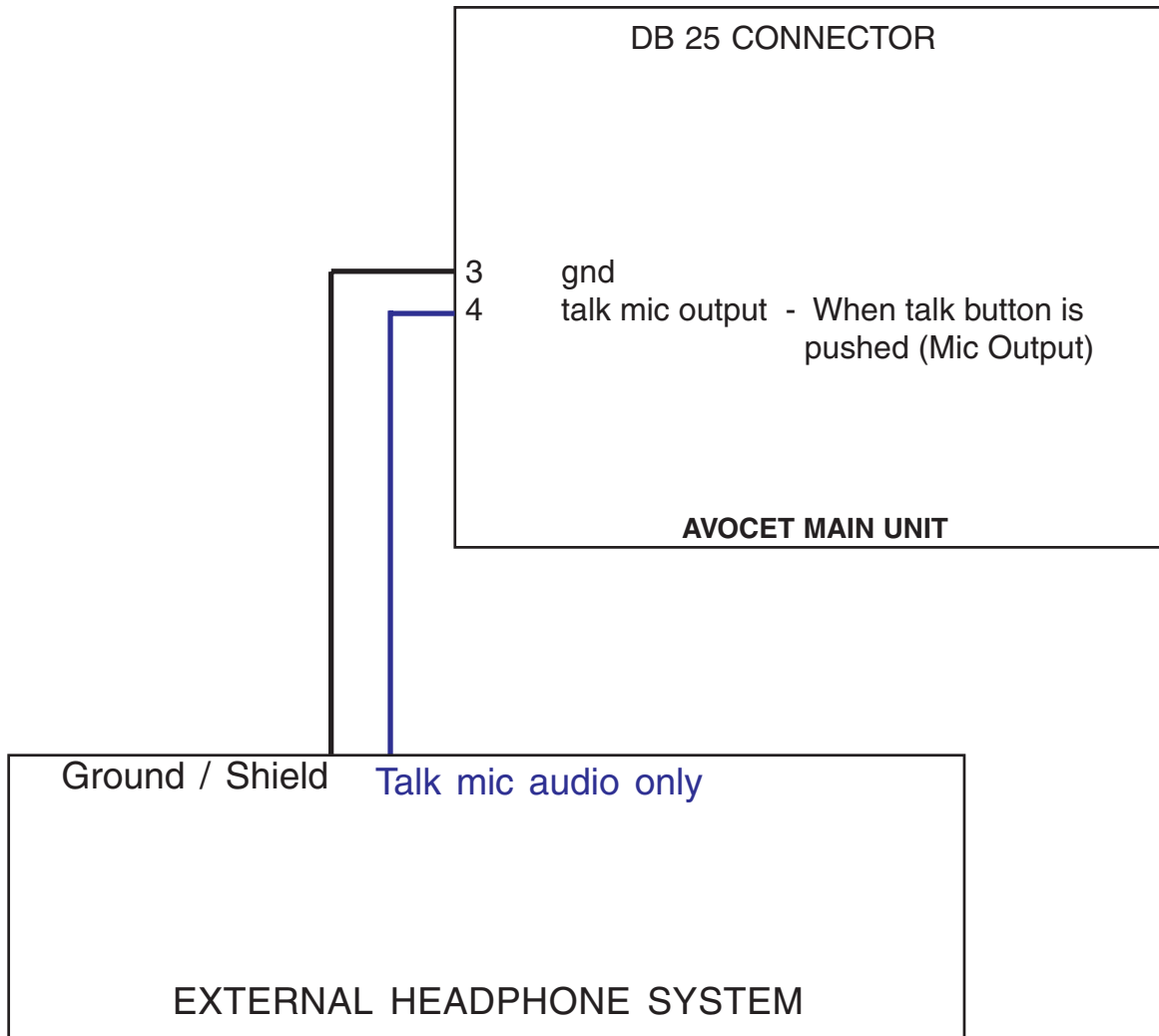

## Avocet alignment

The alignment should not be changed unless you are 100 % positive that you know how to do this and have very good equipment. If not you could mess up the alignment, and the left - right channel balance. The gain trims will provide a plus or minus 3 db range, which can allow for different configurations. Do not attempt to adjust this as a way to reduce the output level. If you do you will mess it up. If you need to reduce the output level use the provided pads. There is 5 db of analog headroom above the zero or red led on the remote's meter.

If the rom has surround firmware set it to stereo operation before power up

Jumper JP1 must be installed on power up

This jumper should not be changed with out power down and power up

With Att at max level, 1khz sine wave

Put the signal into analog 1 and mono the unit

adjust the generator for 1.000V at the (MONO TEST POINT IC7 PIN 1)  
ch1 and ch2 should be equal

R166, R167 are the gain trims (CHANNEL GAIN MATCHING)

adjust the output for 1.783 volts in both channels  
use 5.1k ohm load on the output, measure the output balanced  
turn mono off

**ANALOG INPUT TRIMS** 1.000v in = 1.000v out

adjust the trims for ANA1, ANA2, and AUX inputs they can be reached by small holes next to the xlr connectors on the back

53

**DIGITAL INPUT TRIMS**

select DAW feed a 1khz sine wave at digital full scale  
gain Att. still at max  
adjust for 7.70 volts output this is 20db above 0dbm

Jumpers to select input level metering should be installed

REMOTE METER ADJUST with max digital input adjust the meter trims for meter full scale  
(R165, R166)

**DIGITAL METER OUTPUT WITH ANALOG INPUT**

Apply an 1KHz analog input and adjust it for 7.70 volts out with the att. at max  
(this is the same level as digital zero on the digital input)

With a digital meter connected to the metering output adjust the meter level trims for digital zero

CK the stepped attenuator  
analog input 1 apply a square wave 5V p-p, 1KHz  
look at the output starting at max output  
check for level change in proper sequence and correct wave shape  
If there is a problem at the max setting the other adjustments  
may have to be redone

With 1 volt on ANA1 check, both inputs, the phones, main and mono outputs on the aux connector  
With PHONES MAIN selected and the phones gain at max

mono = 1.5Vp-p on the scope  
If you hit the mute button the mono output should cancel to 0

Phones = 2Vp-p  
Phones = jack 3.1 Vp-p  
L,R channel output = 1.5Vp-p

.005V rms on the talk mic input should result in 15Vp-p at the phones output on the accessory  
connector. Adjust talk mic gain

Test direct control inputs  
talk  
mute  
solo

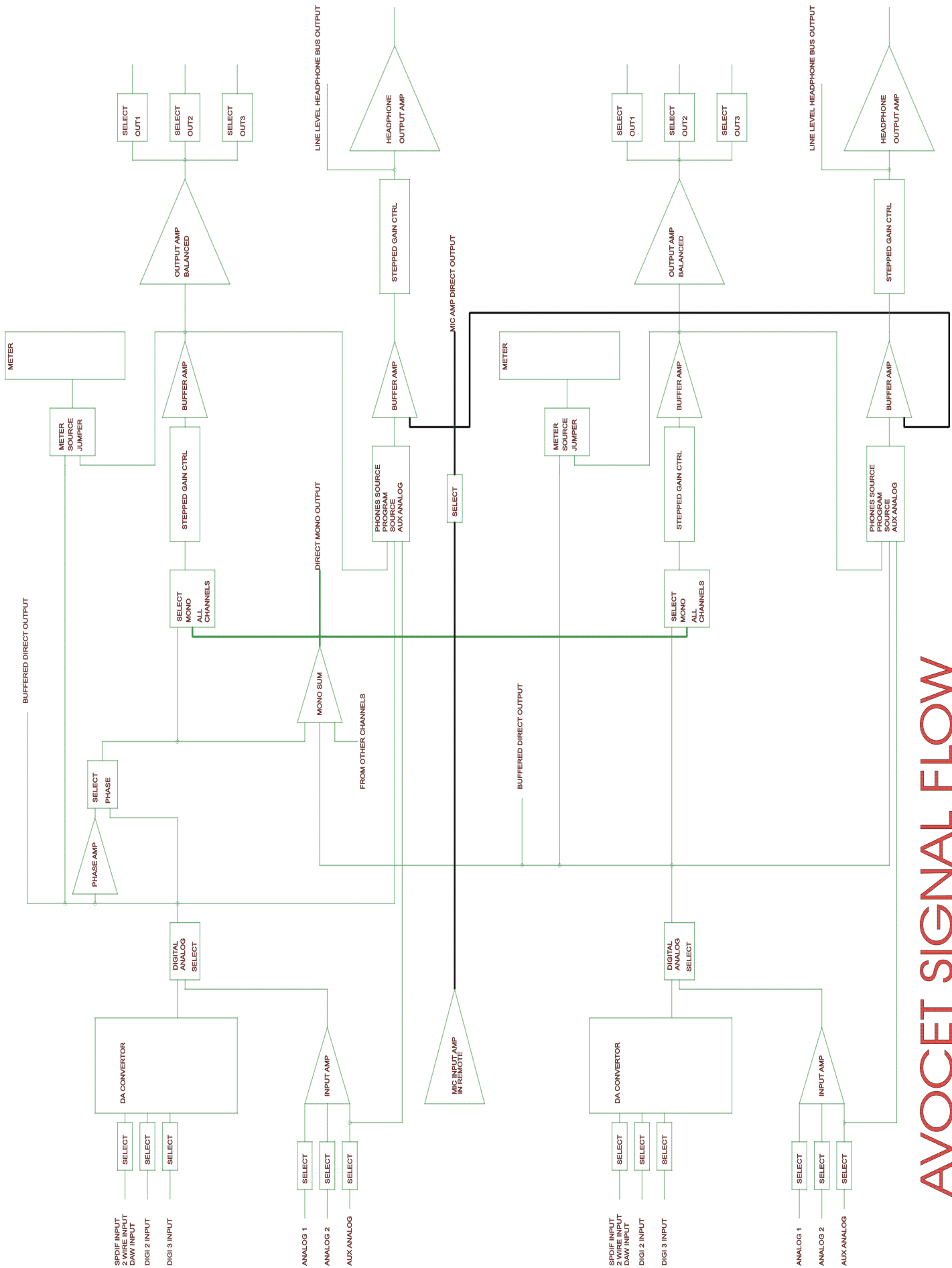

# AVOCET SIGNAL FLOW

PIN #

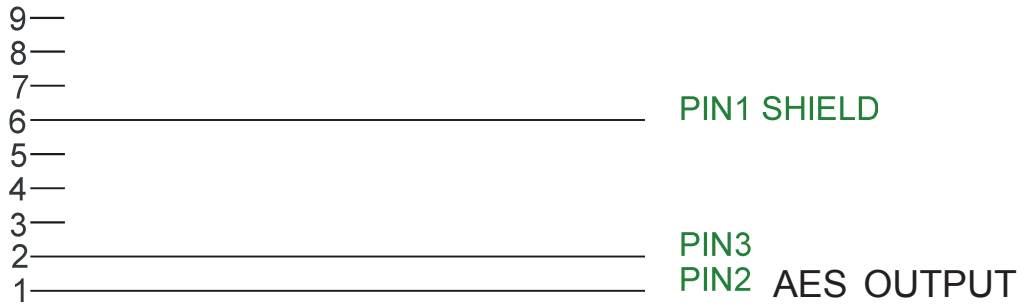

### STEREO DIGITAL METER CABLE

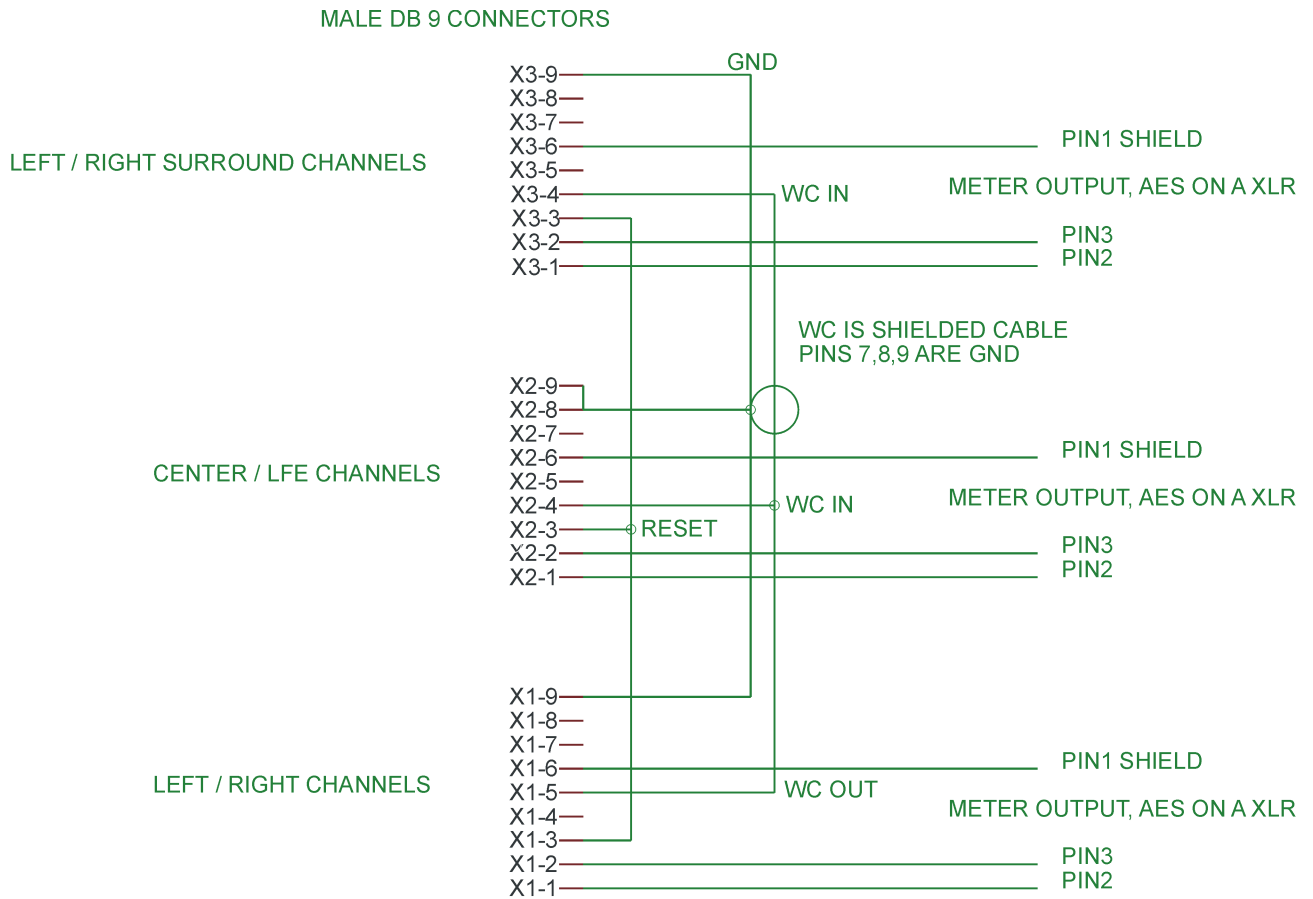

### 5.1 DIGITAL METER CABLE