

The Dangerous Music D-Box user's operating guide



Thank you for choosing products from the exciting line of Dangerous Music recording equipment. Many years of dependable and trouble-free service can be expected from our gear. This has been made possible by careful design, construction, and top-of-the-line component choices by recording industry veterans. The Dangerous D-Box combines the fidelity of the world-renowned 2-Bus with a stereo monitor control system complete with a D/A converter, headphone amplifiers and talkback system.

There are many functions packed into the small space of D-Box. While the D-Box is easy enough to use right out of the shipping package, reading this booklet will help the engineer to realize the full benefits of this system's functions and use.

1.....	introduction
2.....	safety review
3.....	overview
4.....	D-Box front panel
5.....	operation
6.....	D-Box rear panel connections
7.....	connector pin outs
8.....	usage examples
10.....	specifications and contact

Safety Review



The exclamation point within an equilateral triangle is intended to alert the user to the presence of important operating and maintenance (servicing) instructions in the literature accompanying this product.

Certain precautions should be taken when using electrical products. Please observe the safety hints by reading the manual and obtaining qualified help if necessary to adhere to the precautions.



1. Always use a properly grounded power supply cord with this product. Please do not defeat the ground pin on the mains plug. This connection provides earth to the chassis and signal grounds inside the device for clean and quiet operation.



2. Avoid high temperature operation in equipment racks by providing air circulation. The number one killer of electronic gear is HEAT. Vented rack panels may look like wasted space to an interior decorator, but they look like *beauty* to a technician or equipment designer! If the front panel is hot, it is roasting inside the box. This applies to all electronics!



3. Avoid areas of high magnetic fields. The steel chassis of **D-Box** is designed to shield the circuits from EMI and RFI (magnetic and radio interference). When installing equipment in racks, it is prudent to put power amplifiers and large power supplies at least several rack spaces, if not in a different rack, away from equipment that deals with low level signals. Separation of high level and low level equipment can pre-empt trouble caused by heat and EMI.



4. Care should be taken to avoid liquid spills around equipment. If a spill occurs, please shut off the gear and disconnect the mains. A qualified technician should investigate accidents to prevent further equipment damage or personnel hazards caused by spills.



5. The headphone amplifiers are very powerful. Please use caution in setting monitoring and talkback levels to avoid hearing damage. Always start with the level controls at a moderate level (9 o'clock) to avoid damaging equipment or users.



6. If adjustments or jumper changes are required, please disconnect the mains plug before opening the top. Dropped screws or tools on a live circuit board can manifest themselves as burn marks and smoked components. While we feel your pain, (been there) subsequent damage is not covered by the warranty.

Dangerous Music Incorporated reserves the right to change the specifications or modify the designs of its equipment. Sending in the registration card is our way of keeping in touch with users of our equipment should this become necessary. Registration information is always kept confidential and never disclosed to third parties for any reason. Company contact information is on the last page of this manual.



The CE sign on this product signifies the fact that D-Box has been tested and verified to conform to the applicable standards of 89/336/EEC. EN55103-1 (emissions) EN61000-2 (immunity) and EN60065:2002 (safety requirements)



This product uses components of the types and quantities that comply with the EC RoHS standard 2002/95/EC. A list of suppliers and materials is available from DMI. We tightly control production to use top quality materials.

Overview

The Dangerous Music D-Box incorporates elements of several Dangerous Music products into one convenient package. Eight channels of world-class summing technology combine with a monitor speaker controller, headphone amplifiers, talkback system and a high quality D/A converter to give this device unprecedented sound quality and ergonomics in a one RU box. The D-Box is the perfect companion to the smaller studio setup or portable recording system.

The block diagram below gives an overview to the signal flow in D-Box. The summing section has the first six inputs configured as three stereo pairs. Inputs seven and eight have panning controls to allow audio to be placed anywhere in the stereo mix.

The Analog Input is set for professional +4dBu sources but can be programmed to add gain to accommodate low-level consumer devices like an iPod or computer headphone output.

There are two AES digital inputs to monitor stereo digital sources and two stereo headphone amplifiers with independent level controls and talkback for cueing purposes.

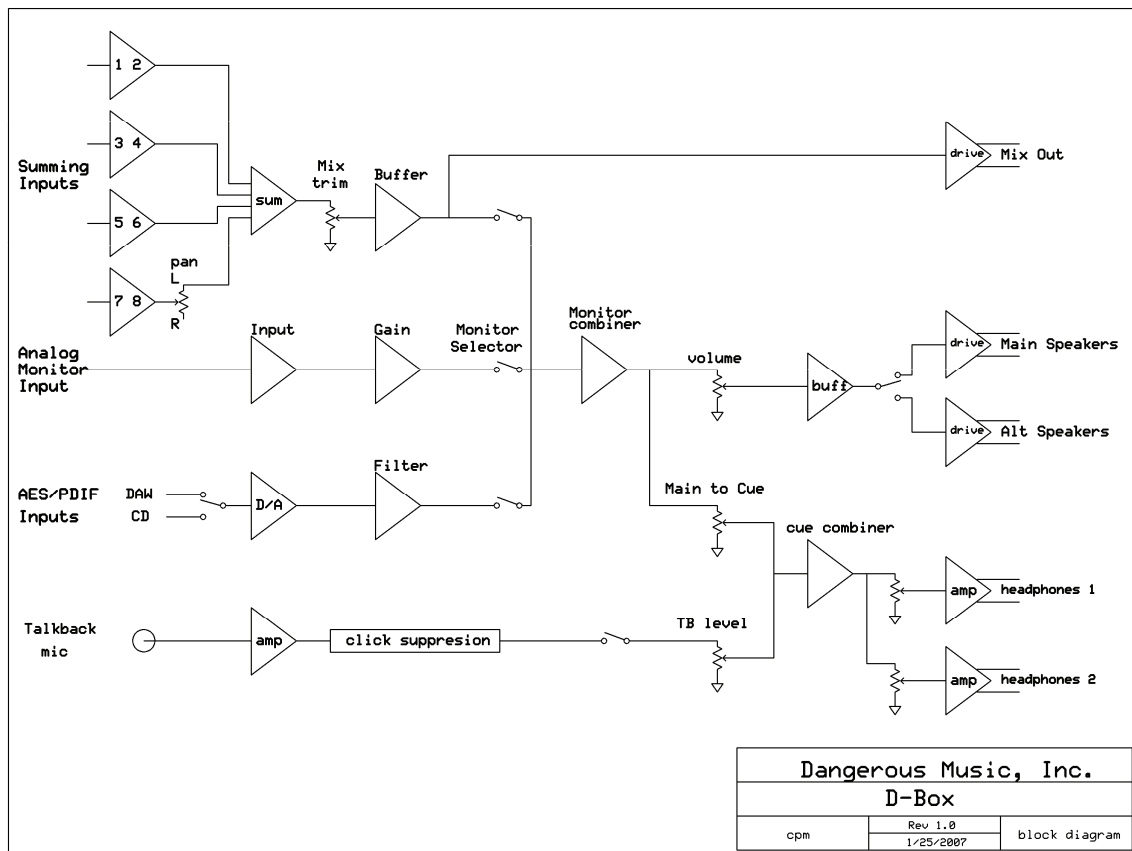

D-Box front panel

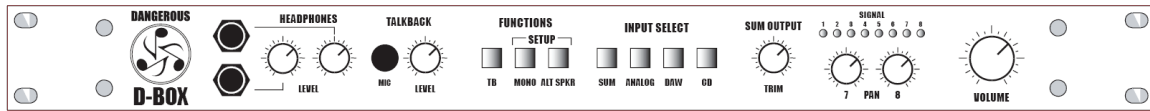

The **Headphones** jacks are fed from the Input Select buttons via their **Level** controls. Please start with the level control down low as the amplifiers are very powerful.

The **Talkback** section has a microphone and **Level** control to adjust the amount of talkback into the cue amplifiers.



The headphone amplifiers are very powerful. Please use caution in setting monitoring and talkback levels to avoid hearing damage.

The **Functions** group controls the talkback, speaker selection, and logic setup.

- TB** The **TB** switch injects the microphone into the Headphones (cue) system.
- Mono** The **Mono** switch combines the left and right channels to the speakers.
- Alt Spkr** The **Alt Spkr** switch lets the engineer switch between two sets of speakers.

These switches feature “momentogglе”, explained on the next page, along with the mode **Setup** functions.

The **Input Select** section has two analog and two digital sources to choose from. The selected input is sent to both the speakers and headphone amplifiers.

- Sum** This switch selects the stereo summing mix output.
- Analog** This switch selects an analog input source.
- DAW**
- CD** There are 2 digital inputs that feed the D/A converter. The converter will recognize and lock to either AES or SPDIF sources. Only one digital source may be monitored at a time.

Pushing a lit Input Select switch will mute that input.

The **Sum Output Trim** knob adjusts the summing mix gain from unity when fully clockwise, to approximately -12dB when fully counter-clockwise. It should normally be near the 12:00 position and is used to adjust the mix for optimum level into the mixdown A/D converter.

Signal LEDs light to indicate the presence of audio at the summing section inputs. The first six channels of the summing section are fed to the stereo bus in pairs, but **7 & 8** have **Pan** pots to place their signals anywhere in the mix.

The **Volume** control adjusts the level of the monitor speakers.

The **Functions** switches, and **Setup** options

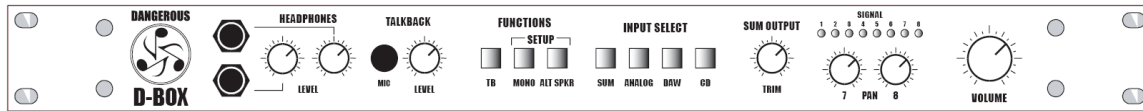

The function switches feature “momentoggle”. If the buttons are pressed and released quickly, they will latch on. If pressed and held for more than a second, the function holds until the button is released. Momentoggle works both ways. The selected function can be latched on or off with the switches.

Be *careful* with the talkback switch to make sure that it is not latched on when you are finished addressing the artist! (“*Great Take!*” *God, I wish that guy could sing in tune, click*). A talkback remote switch plugged into the jack on the rear panel does not latch in any mode to keep the producer out of trouble.

Setup options

Pressing the **Mono** and **Alt Spkr** buttons simultaneously enters **Setup** mode. These two switches flash alternately and the computer is waiting to set the Input Selection mode and the Analog Monitor gain.

Normally, the **Input Select** buttons will let the user monitor one input at a time. Pressing the **Sum** switch while in **Setup** mode lights the Sum switch and lets the user listen to any combination of inputs mixed together after exiting Setup. Pressing the lit **Sum** switch extinguishes the light and returns the D-Box back to normal monitoring mode.

The **Analog** monitor input is normally set for +4dBu sources. Pressing the **Analog** switch in **Setup** mode lights the switch and adds 11.7dB of gain to accommodate consumer – 10dBV and other low-level devices. Pressing the lit **Analog** switch while in Setup extinguishes the light and returns the gain to unity.

Exit **Setup** mode by pressing one of the flashing switches. The D-Box is reset and the mode changes are saved.

D-Box rear panel

This page reviews the connections to D-Box. All XLRs are balanced with pin 2 hot.

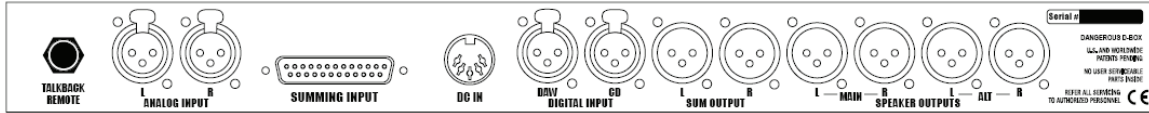

Talkback Remote Use a tip/ring/sleeve (balanced 1/4”) plug for this jack. Closing the ring to the tip activates the Talkback function of D-Box.

Analog Input This input lets the engineer monitor +4dBu or -10dBV analog devices as programmed in Setup mode.

Summing Input This 25 way ‘D’ connector uses the Tascam Standard for 8 channels of balanced analog input.

DC IN The universal power supply plugs into this jack.



Plug the power supply into the D-Box before connecting to the AC Mains. Hot plugging the supply will arc the contacts.

Digital Input The stereo D/A converter can play AES or SPDIF sources through the D-Box monitor section. Please note that only one digital source can be monitored at a time.

Sum Output The eight channels of analog audio fed into the Summing Input are mixed to a stereo pair for recording through a mixdown A/D converter either directly or via one’s favorite analog signal processors.

Speaker Outputs The D-Box can feed two sets of speakers, a Main or Alternate pair.

Connector pin outs are on the next page.

Connector pin-outs

External talkback key

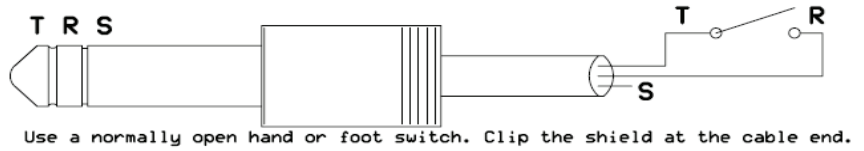

'D' connector pin out

<i>pin #</i>	<i>Channel</i>	<i>signal</i>
1	8	high
14	8	low
2	8	shield
15	7	high
3	7	low
16	7	shield
4	6	high
17	6	low
5	6	shield
18	5	high
6	5	low
19	5	shield
7	4	high
20	4	low
8	4	shield
21	3	high
9	3	low
22	3	shield
10	2	high
23	2	low
11	2	shield
24	1	high
12	1	low
25	1	shield
13	not used	

Power Supply connector

<i>pin #</i>	<i>signal</i>
1	Common
2	Gnd
3	+5v
4	-15v
5	+15v

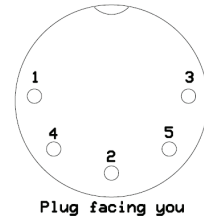

Suggested set ups

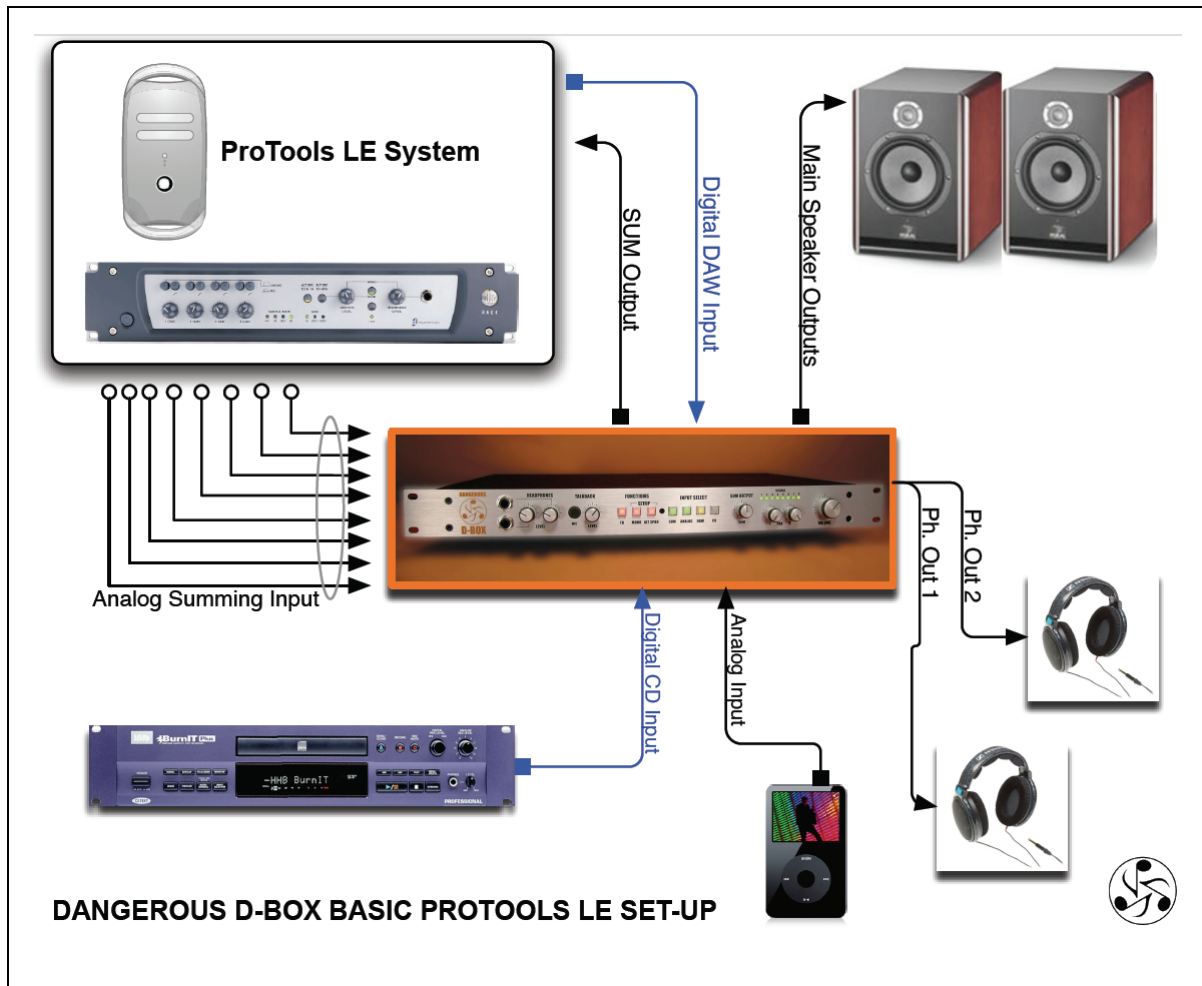

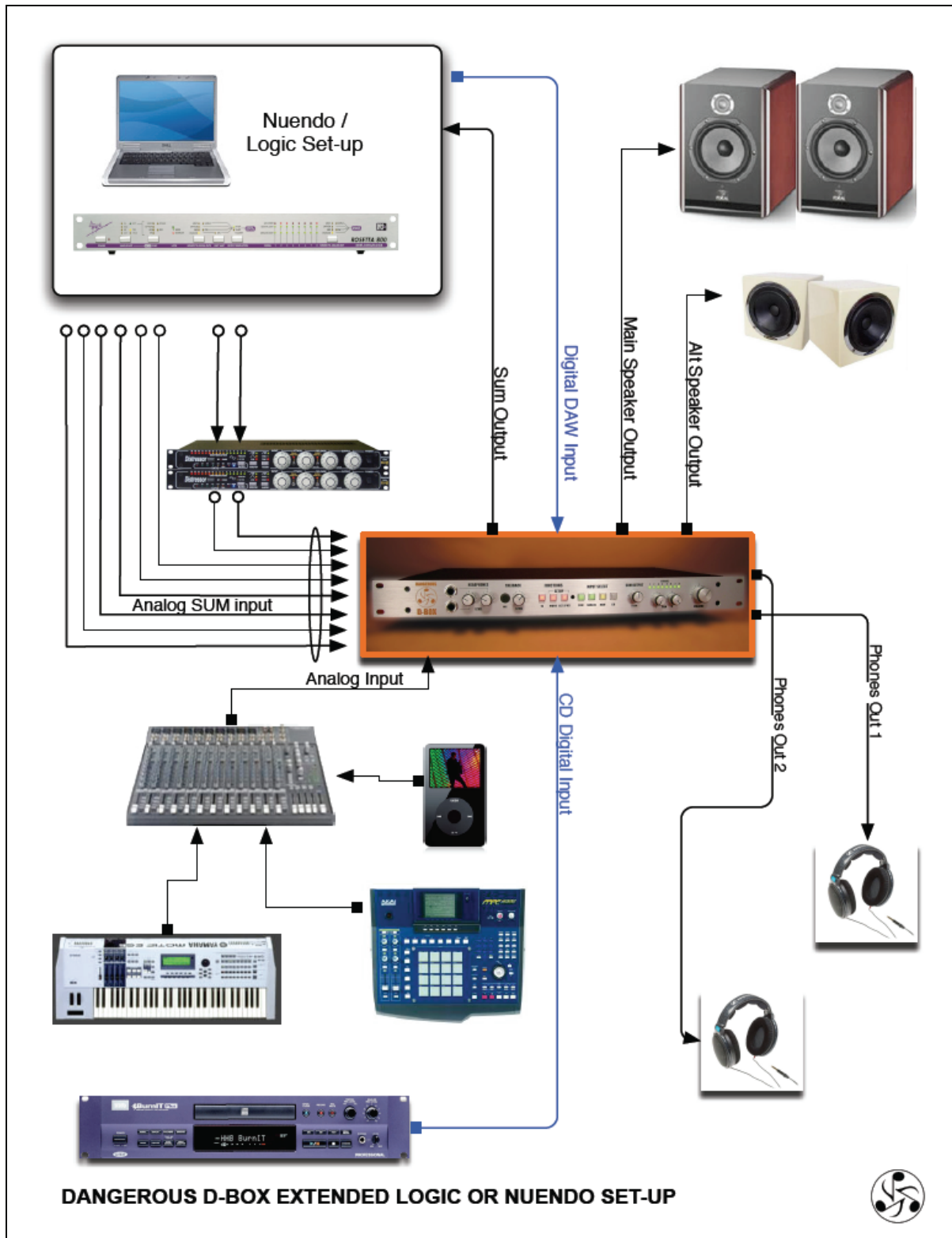

This more involved setup uses a console to provide extended cue and mixing options. It is easy to configure the D-Box to listen to multiple sources while composing, practicing, and recording.

Specifications

Summing Section

Frequency Response	1Hz-100kHz within 0.1dB
THD+N	< 0.003%
IMD	< 0.0035%
Crosstalk	< -97dB
Noise	< -89dBu total energy in audio band
Maximum Input	+27dBu

Monitor Section

Frequency Response	1Hz-100kHz within 0.1dB
THD+N	< 0.002%
IMD	< 0.003%
Crosstalk	< -101dB
Noise	< -92dBu total energy in audio band
Maximum Input	+26dBu

D/A Converter

Lock Range	Fs=30kHz-100kHz
Crosstalk	< -101dB
Noise	-92dBu
THD+N	0.005%

Warranty

One year parts and labor for defects in unit production. Damage caused by accident, abuse, or shipping, as determined by factory examination, may result in repair fees payable before unit is returned. Shipping charges to the factory are the responsibility of the customer. Warranty repairs are shipped back free of charge to the customer. Please retain packing box and foams for storage and shipping purposes.

USA

Dangerous Music, Inc.
231 Stevens Road
Edmeston, NY 13335

Phone: 607 965-8011
Fax: 607-965-8012
Email: info@dangerousmusic.com

Europe

Dangerous Music, Inc.
Stieleichenweg 55
50999 Köln

Tel: +49.0.2236.393731

E-mail: info@dangerousmusic.de

Dangerous Music, Inc. reserves the right to alter the software and design of their equipment. If after reading the manual more information for an application is needed, please contact us by email for the quickest response. Factory contact must also happen before shipping a unit to us for service. Please keep the original cartons in case storage or transportation of units is necessary and always insure shipment as mechanical damage is not covered by the warranty.