

# Pro Tools Reference Guide

**Version 6.4 for HD or LE Systems on Windows or Macintosh**

## **Digidesign**

2001 Junipero Serra Boulevard  
Daly City, CA 94014-3886 USA  
tel: 650-731-6300  
fax: 650-731-6399

### **Technical Support (USA)**

tel: 650-731-6100  
fax: 650-731-6384

### **Product Information (USA)**

tel: 650-731-6102  
tel: 800-333-2137

### **International Offices**

Visit the Digidesign Web site  
for contact information

### **Web Site**

[www.digidesign.com](http://www.digidesign.com)



**digidesign**

**Copyright**

This guide is copyrighted ©2004 by Digidesign, a division of Avid Technology, Inc. (hereafter "Digidesign"), with all rights reserved. Under copyright laws, this guide may not be duplicated in whole or in part without the written consent of Digidesign.

DIGIDESIGN, AVID and PRO TOOLS are trademarks or registered trademarks of Digidesign and/or Avid Technology, Inc. All other trademarks are the property of their respective owners.

Product features, specifications, system requirements, and availability are subject to change without notice.

PN 910613117-00 REV A 04/04

# Contents

---

## Part I Introduction

<b>Chapter 1. Welcome to Pro Tools</b> . . . . .	3
The Pro Tools Guides . . . . .	3
Digidesign Registration . . . . .	4
Compatibility Information . . . . .	4
About <a href="http://www.digidesign.com">www.digidesign.com</a> . . . . .	4
<b>Chapter 2. Pro Tools System Configurations</b> . . . . .	5
Pro Tools TDM Systems . . . . .	5
Pro Tools LE Systems . . . . .	9
<b>Chapter 3. Pro Tools Concepts</b> . . . . .	11
Hard Disk Audio Recording . . . . .	11
The Digidesign Audio Engine . . . . .	11
Pro Tools Sessions . . . . .	12
System Resources . . . . .	16
MIDI Concepts . . . . .	19
<b>Chapter 4. Pro Tools Windows</b> . . . . .	21
The Mix Window . . . . .	21
The Edit Window . . . . .	21
The Transport Window . . . . .	25
<b>Chapter 5. Keyboard Shortcuts</b> . . . . .	29
Global Key Commands . . . . .	29
Keyboard Focus . . . . .	30
Numeric Keypad Modes . . . . .	31

---

## Part II                      Sessions & Tracks

<b>Chapter 6. Sessions</b> . . . . .	37
Starting Up or Shutting Down Your System . . . . .	37
Configuring Pro Tools System Settings (in the Playback System Engine) . . . . .	37
Configuring Pro Tools Hardware Settings . . . . .	41
Creating a New Session . . . . .	45
Opening a Session . . . . .	47
Saving a Session . . . . .	48
Creating Custom Session Templates . . . . .	51
Closing a Session . . . . .	53
Quitting Pro Tools . . . . .	53
Sharing Sessions Between Pro Tools TDM Systems and Pro Tools LE Systems . . . . .	53
Preferences . . . . .	54
<b>Chapter 7. I/O Setup</b> . . . . .	67
The I/O Setup Dialog . . . . .	70
Routing Hardware I/O to Pro Tools I/O . . . . .	71
Creating and Editing Paths . . . . .	73
I/O Settings Files . . . . .	80
I/O Setup Options . . . . .	82
H/W Insert Delay Compensation . . . . .	84
<b>Chapter 8. Tracks</b> . . . . .	85
Track Types . . . . .	85
Track Controls . . . . .	88
Creating Tracks . . . . .	91
Hiding Tracks . . . . .	93
Assigning Inputs and Outputs to Tracks . . . . .	95
Track Priority and Voice Assignment . . . . .	96
Setting MIDI Input and Output . . . . .	99
Soloing and Muting Tracks . . . . .	100
Making Tracks Inactive . . . . .	102
Adjusting Track Width . . . . .	102
Color Coding Tracks . . . . .	103
Grouping Tracks . . . . .	103
<b>Chapter 9. Importing and Exporting Session Data</b> . . . . .	109
Importing Audio . . . . .	109
Conversion Quality . . . . .	111
Importing Audio Files and Regions . . . . .	111
Importing Audio Files with Drag & Drop from a DigiBase Browser . . . . .	113
Importing Audio from an Audio CD . . . . .	114
Importing Tracks and Track Attributes . . . . .	114



Exporting Audio . . . . .	121
Exporting Pro Tools Tracks as OMFI or AAF Files . . . . .	123
Exporting Sessions as Text . . . . .	123
Importing MIDI Files . . . . .	125
Exporting MIDI Files . . . . .	126
<b>Chapter 10. File Management and Compatibility . . . . .</b>	<b>129</b>
Audio File Management . . . . .	129
WAV File Compatibility . . . . .	131
Creating Macintosh and PC Compatible Sessions . . . . .	131
Moving Sessions Between Platforms with MacOpener (Using HFS/HFS+ Drives) . . . . .	133

---

## Part III                      Recording

<b>Chapter 11. Record Setup . . . . .</b>	<b>137</b>
Input Connections and Audio Levels . . . . .	137
Record Enabling Tracks . . . . .	138
Record Monitoring Modes . . . . .	140
TrackInput Monitoring . . . . .	141
Monitoring Latency . . . . .	142
Low Latency Monitoring During Recording . . . . .	144
Default Track Names . . . . .	144
Disk Allocation . . . . .	145
Allocating Hard Drive Space for Recording . . . . .	147
Record Modes . . . . .	148
Recording with a Click . . . . .	151
Setting the Default Meter and Tempo . . . . .	153
<b>Chapter 12. Basic Audio Recording . . . . .</b>	<b>157</b>
Recording an Audio Track . . . . .	157
Record Shortcuts . . . . .	161
Record Pause Mode . . . . .	161
Recording Additional Takes . . . . .	161
Punch Recording Audio . . . . .	163
Loop Recording Audio . . . . .	165
Auditioning Record Takes . . . . .	166
Setting Punch/Loop Points . . . . .	168
Recording from a Digital Source . . . . .	172
Half-Speed Recording and Playback . . . . .	174

<b>Chapter 13. MIDI Recording</b> . . . . .	175
Recording from MIDI Devices . . . . .	175
Enabling Input Devices . . . . .	176
MIDI Thru . . . . .	177
MIDI Input Filter . . . . .	178
Input Quantize . . . . .	178
Wait for Note . . . . .	179
MIDI Merge/Replace. . . . .	179
Configuring MIDI Tracks for Recording . . . . .	180
Recording to MIDI Tracks . . . . .	182
Punch Recording MIDI . . . . .	183
Loop Recording MIDI . . . . .	185
Recording System Exclusive Data. . . . .	188
<b>Chapter 14. Advanced Recording</b> . . . . .	191
QuickPunch Audio Recording. . . . .	191
TrackPunch Audio Recording. . . . .	194

---

**Part IV           Editing**

<b>Chapter 15. Editing Basics</b> . . . . .	207
Pro Tools Editing . . . . .	207
Track Material . . . . .	208
Displaying Region Names and Times . . . . .	212
Audio Regions and Waveforms . . . . .	212
MIDI Regions and MIDI Data . . . . .	214
Playlists. . . . .	217
Multiple Undo . . . . .	219
The Audio and MIDI Regions Lists . . . . .	220
Edit Modes . . . . .	224
Zooming . . . . .	226
The Universe Window . . . . .	231
Timebase Rulers . . . . .	232
Main Time Scale . . . . .	233
Tick-Based Timing . . . . .	235
<b>Chapter 16. Playing and Selecting Track Material</b> . . . . .	237
Playing Tracks . . . . .	237
Auto-Scrolling Tracks in the Edit and Mix Windows . . . . .	240
Scrolling Options . . . . .	241
The Scrubber . . . . .	242
Linking or Unlinking Edit and Timeline Selections . . . . .	245
Selecting Track Material . . . . .	246

Playing Selections . . . . .	255
Timeline Selections . . . . .	257
Playing Edit and Timeline Selections with the Playhead . . . . .	258
<b>Chapter 17. Working with Regions and Selections . . . . .</b>	<b>261</b>
Creating New Regions . . . . .	261
Healing a Separation . . . . .	264
Placing Regions in Tracks . . . . .	264
The Trimmer Tool . . . . .	267
Sliding Regions . . . . .	271
Nudging . . . . .	276
Shift Command . . . . .	278
Quantizing Regions . . . . .	279
Locking Regions . . . . .	279
Muting/Unmuting Regions . . . . .	280
Edit Commands . . . . .	280
Duplicate Command . . . . .	283
Repeat Command . . . . .	284
Merge Paste Command . . . . .	285
Editing Stereo and Multichannel Tracks . . . . .	285
Processing Audio with AudioSuite Plug-Ins . . . . .	286
Waveform Repair with the Pencil Tool . . . . .	287
The Smart Tool . . . . .	288
<b>Chapter 18. Advanced Editing (TDM Systems Only) . . . . .</b>	<b>291</b>
Replacing Audio Regions . . . . .	291
Repeat Paste To Fill Selection . . . . .	293
Compress/Expand Edit To Play . . . . .	293
<b>Chapter 19. Fades and Crossfades . . . . .</b>	<b>295</b>
Using Crossfades . . . . .	295
Creating a Crossfade . . . . .	302
Creating Fades at the Beginnings and Ends of Regions . . . . .	303
Using AutoFades . . . . .	305
Creating Fades and Crossfades in Batches . . . . .	305
<b>Chapter 20. Managing Regions . . . . .</b>	<b>307</b>
Stripping Silence from Regions . . . . .	307
Inserting Silence . . . . .	309
Consolidate Selection Command . . . . .	310
Compacting an Audio File . . . . .	310
Naming and Displaying Regions . . . . .	311

<b>Chapter 21. Conductor Tracks and Memory Locations</b> . . . . .	315
Tempo Events . . . . .	315
Default Tempo . . . . .	318
Identify Beat Command . . . . .	318
Meter Events . . . . .	321
Renumbering Bars . . . . .	323
Memory Locations and Markers . . . . .	324
Memory Locations Window . . . . .	330
<b>Chapter 22. Beat Detective</b> . . . . .	333
Beat Detective Requirements . . . . .	334
The Beat Detective Window . . . . .	335
Beat Detective Modes . . . . .	335
Defining a Beat Detective Selection . . . . .	336
Calculating Tempo with Beat Detective . . . . .	337
Generating Beat Triggers . . . . .	338
Generating Bar Beat Markers with Beat Detective . . . . .	341
DigiGroove Templates . . . . .	342
Separating Regions with Beat Detective . . . . .	344
Conforming Regions with Beat Detective . . . . .	346
Edit Smoothing . . . . .	348
Detection (Normal) and Collection Mode . . . . .	349

---

**Part V           MIDI Editing**

<b>Chapter 23. MIDI Editing</b> . . . . .	355
The Pencil Tool . . . . .	355
Custom Note Duration . . . . .	356
Setting the Grid Value . . . . .	357
Inserting MIDI Notes . . . . .	357
Manually Editing MIDI Notes . . . . .	359
Continuous Controller Events . . . . .	364
Patch Select (Program and Bank Changes) . . . . .	366
System Exclusive Events . . . . .	369
Note and Controller Chasing . . . . .	370
Offsetting MIDI Tracks . . . . .	371
Stuck Notes . . . . .	372
<b>Chapter 24. MIDI Operations</b> . . . . .	373
MIDI Operations Window . . . . .	373
Select Notes . . . . .	374
Change Velocity . . . . .	376
Change Duration . . . . .	378

Transpose . . . . .	379
Quantize . . . . .	380
Input Quantize . . . . .	385
Groove Quantize . . . . .	385
Restore Performance . . . . .	390
Flatten Performance . . . . .	391
<b>Chapter 25. MIDI Event List . . . . .</b>	<b>393</b>
The MIDI Event List . . . . .	393
Inserting Events in the MIDI Event List . . . . .	396
Editing in the MIDI Event List . . . . .	398
MIDI Event List Options . . . . .	400

---

**Part VI            Mixing**

<b>Chapter 26. Basic Mixing . . . . .</b>	<b>403</b>
Mixing Concepts . . . . .	403
Metering and Calibration . . . . .	403
Audio Signal Flow . . . . .	404
Inserts . . . . .	408
Views in the Mix and Edit Windows . . . . .	408
Track Input . . . . .	410
Track Output . . . . .	411
Sends . . . . .	414
Output Windows for Tracks and Sends . . . . .	418
Submixing for Signal Routing and Effects Processing . . . . .	423
Delay Compensation . . . . .	428
Dither . . . . .	430
Using a Control Surface with Pro Tools . . . . .	432
<b>Chapter 27. Plug-In and Hardware Inserts . . . . .</b>	<b>433</b>
Inserting Plug-Ins on Tracks . . . . .	437
Moving and Duplicating Plug-In and Hardware Inserts . . . . .	439
The Plug-In Window . . . . .	440
Editing Plug-In Controls . . . . .	444
Using Hardware Inserts . . . . .	446
Connecting and Integrating External Devices . . . . .	447

<b>Chapter 28. Automation</b> . . . . .	451
Automation Quick Start . . . . .	451
Automation Playlists . . . . .	452
Automation Modes . . . . .	453
Automation Preferences . . . . .	456
Viewing Automation . . . . .	458
Writing Automation . . . . .	459
Enabling and Suspending Automation . . . . .	463
Deleting Automation . . . . .	464
Thinning Automation . . . . .	465
Drawing Automation . . . . .	465
Editing Automation . . . . .	467
Writing Automation to the Start, End or All of a Selection . . . . .	473
Trimming Automation . . . . .	475
Creating Snapshot Automation . . . . .	475
 <b>Chapter 29. Mixdown</b> . . . . .	 479
Recording to Tracks . . . . .	481
Bounce to Disk . . . . .	482
Bounce Options . . . . .	483
Recording a Submix (with Bounce To Disk) . . . . .	491
Final Mixdown . . . . .	492
Mastering . . . . .	493

---

**Part VII           Surround**

<b>Chapter 30. Surround Concepts</b> . . . . .	497
Mixing Formats and Surround Formats . . . . .	497
Pro Tools Mixing Formats . . . . .	498
Speaker Layouts . . . . .	498
Surround Monitoring . . . . .	500
Formats and Terminology . . . . .	501
Surround Mixing Concepts . . . . .	504
 <b>Chapter 31. Pro Tools Setup for Surround</b> . . . . .	 507
Pro Tools Audio Connections for 5.1 Mixing . . . . .	507
Configuring Pro Tools for Multichannel Sessions . . . . .	508
Default I/O Selectors in I/O Setup . . . . .	512
5.1 Track Layouts, Routing, and Metering . . . . .	512

<b>Chapter 32. Multichannel Tracks and Signal Routing</b> . . . . .	513
Multichannel Quick Start . . . . .	513
Multichannel Audio Tracks . . . . .	514
Multichannel Signal Routing . . . . .	516
Paths in Surround Mixes . . . . .	519
Example Paths and Signal Routing for a Surround Mix . . . . .	521
<b>Chapter 33. Surround Panning and Mixing</b> . . . . .	525
Introduction to Pro Tools Surround Panning . . . . .	525
Output Window . . . . .	526
Standard Controls . . . . .	527
Surround Panner Controls . . . . .	528
Panning Modes . . . . .	530
LFE Faders in Multichannel Panners . . . . .	533
Divergence and Center Percentage . . . . .	533
SurroundScope Metering Plug-In . . . . .	536

---

**Part VIII                    Synchronization**

<b>Chapter 34. Synchronization Concepts</b> . . . . .	539
Synchronization Requirements . . . . .	539
Aspects of Synchronization . . . . .	539
Synchronizing Pro Tools . . . . .	540
SMPTE Frame Formats . . . . .	543
Working with Film-Originated Material . . . . .	544
<b>Chapter 35. Working with Synchronization</b> . . . . .	549
Pro Tools Synchronization Options . . . . .	549
Session Setup Window . . . . .	551
Preparing to Work with SMPTE . . . . .	556
Configuring Pro Tools for SMPTE . . . . .	556
Pull Up and Pull Down . . . . .	558
Putting Pro Tools Online . . . . .	562
Generating Time Code . . . . .	563
Using MIDI Machine Control . . . . .	564
Synchronizing a Sequencer to Pro Tools on Macintosh . . . . .	566
Setting Minimum Sync Delay . . . . .	566
Remote Track Arming . . . . .	566
MIDI Beat Clock . . . . .	567
Spotting Regions to SMPTE Frame Locations . . . . .	567
Time Stamping . . . . .	570
Identifying a Synchronization Point . . . . .	572
Troubleshooting Synchronization . . . . .	573

<b>Chapter 36. Working with QuickTime Movies</b> . . . . .	575
About QuickTime . . . . .	575
QuickTime Requirements . . . . .	577
Movie Playback Quality Options . . . . .	577
Importing a QuickTime Movie . . . . .	578
Firewire Playback of QuickTime DV Movies . . . . .	579
About the Movie Window . . . . .	581
Setting the Movie Start Time (Movie Offset) . . . . .	582
Spotting Audio to a QuickTime Movie . . . . .	583
Importing QuickTime Audio (and Other Compressed Video Files) . . . . .	584
Bouncing to a New Movie . . . . .	586
<b>Appendix A. DSP-Induced Delays in Mixing (TDM Only)</b> . . . . .	589
Introduction to DSP-Induced Delay . . . . .	589
Delay Compensation . . . . .	590
Manually Compensating for Delays . . . . .	591
Delay Factors . . . . .	592
<b>Appendix B. TDM Mixing and DSP Usage</b> . . . . .	595
Benefits of TDM II . . . . .	595
DSP Allocation . . . . .	597
DSP Usage with TDM Mixers . . . . .	600
DSP Usage with TDM Plug-Ins . . . . .	608
DSP Usage and I/O Allocation . . . . .	609
<b>Appendix C. Troubleshooting</b> . . . . .	611
Backing Up Your Work . . . . .	611
Common Issues . . . . .	611
Using DigiTest as a Diagnostic Tool . . . . .	612
Performance Factors . . . . .	613
Before You Call Digidesign Technical Support . . . . .	613
<b>Glossary</b> . . . . .	615
<b>Index</b> . . . . .	625



# Part I: Introduction



# Chapter 1: Welcome to Pro Tools

Welcome to Pro Tools®. Pro Tools integrates powerful multitrack digital audio and MIDI sequencing features, giving you everything you need to record, arrange, edit, mix, and master quality audio for music, video, film, and multimedia.

---

## The Pro Tools Guides

Pro Tools systems include the following guides:

**Getting Started Guide** Instructions for installing your Pro Tools system and connecting your studio.

**Basics Guide (Mbox Systems Only)** Designed for new users, this guide provides specific methods for accomplishing common tasks (such as getting sound in and out of your Mbox, connecting a mic or instrument, and recording a session).

**Pro Tools Reference Guide** Full details on all Pro Tools functionality and operations. (Pro Tools LE systems only include an electronic PDF version of the *Reference Guide*.)

**Pro Tools Menus Guide** Electronic PDF guide to the Pro Tools on-screen menus.

**DigiRack Plug-Ins Guide** Instructions for using the DigiRack plug-ins (included with Pro Tools) for both real-time and file-based audio processing in Pro Tools. (Pro Tools LE systems only include an electronic PDF version of this guide.)

**Digidesign Plug-Ins Guide** Electronic PDF guide with instructions for using optional Digidesign plug-ins for both real-time and file-based audio processing in Pro Tools.

**DigiBase Guide** Full details on using Pro Tools DigiBase databasing and browsers for data and media management. (Pro Tools LE systems only include an electronic PDF version of this guide.)

**Expanded Systems Guide (TDM Systems Only)** Instructions for expanding a Pro Tools TDM system with optional Digidesign cards, or an expansion chassis.

**MachineControl Guide (TDM Systems Only)** Electronic PDF guide for MachineControl option (available separately). This guide includes installation and operation instructions for using the MachineControl option for Pro Tools to enable serial communication with remote audio and video machines.

**Pro Tools Keyboard Shortcuts** Separate electronic PDFs for Windows and Macintosh that list keyboard shortcuts not shown in Pro Tools menus.

 *Digidesign also provides guides with audio interfaces, optional dedicated consoles (such as D-Control) and controllers (such as Command|8), and other Digidesign options (such as MIDI I/O, PRE, and SYNC I/O). Refer to the separate guide provided with each Digidesign product.*

## Conventions Used in These Guides

The Pro Tools guides use the following conventions to indicate menu choices and key commands:

Convention	Action
File > Save Session	Choose Save Session from the File menu
Control+N	Hold down the Control key and press the <i>N</i> key
Control-click	Hold down the Control key and click the mouse button
Right-click (Windows)	Click with the right mouse button

The following symbols are used to highlight important information:

 *User Tips are helpful hints for getting the most from your Pro Tools system.*

 *Important Notices include information that could affect your Pro Tools session data or the performance of your Pro Tools system.*

 *Shortcuts show you useful keyboard or mouse shortcuts.*

 *Cross References point to related sections in Digidesign guides.*

---

## Digidesign Registration

Be sure to complete and return the registration card included with your Pro Tools system. Registered users will receive periodic software update and upgrade notices. Refer to the registration card for technical support and warranty information.

---

## Compatibility Information

Digidesign can only assure compatibility and provide support for hardware and software it has tested and approved. For a list of Digidesign-qualified computers, operating systems, and third-party devices, refer to the latest compatibility information on the Digidesign Web site ([www.digidesign.com/compato](http://www.digidesign.com/compato)).

---

## About [www.digidesign.com](http://www.digidesign.com)

The Digidesign Web site ([www.digidesign.com](http://www.digidesign.com)) is your best source for information to help you get the most out of your Pro Tools system. The following are just a few of the services and features available.

**Support** Contact Digidesign Technical Support or Customer Service; download software updates and the latest online manuals; browse the Compatibility documents for system requirements; search the online Answerbase or join the worldwide Pro Tools community on the Digidesign User Conference.

**Training and Education** Study on your own using courses available online or find out how you can learn in a classroom setting at a certified Pro Tools training center.

**Products and Developers** Learn about Digidesign products; download demo software or learn about our Development Partners and their plugins, applications, and hardware.

**News and Events** Get the latest news from Digidesign or sign up for a Pro Tools demo.

To learn more about these and other resources available from Digidesign, visit our Web site ([www.digidesign.com](http://www.digidesign.com)).

# Chapter 2: Pro Tools System Configurations

There are two types of Pro Tools systems: TDM and LE. These refer to both the Pro Tools software and its associated hardware, as follows:

- TDM = Pro Tools TDM software for Pro Tools|HD-series and Pro Tools|24 MIX-series hardware.
- LE = Pro Tools LE software for Digi 002, Digi 002 Rack, Digi 001, or Mbox hardware.

---

## Pro Tools TDM Systems

Pro Tools TDM systems are available in the configurations shown below. Each system requires at least one Digidesign audio interface (sold separately). TDM systems can be expanded by adding Digidesign cards to increase track count, add to the amount of possible plug-in and mixer processing, and connect additional audio interfaces.

**A** *Pro Tools system performance depends on factors such as computer processor speed, amount of system memory, and hard drive performance. Contact your Digidesign dealer or visit Digidesign's Web site for the latest system requirements and compatibility information.*

## HD-Series Systems

### Pro Tools|HD 1

Includes:

- HD Core card
- Pro Tools TDM software

### Pro Tools|HD 2 Accel

Includes:

- HD Core card
- HD Accel card
- Pro Tools TDM software

### Pro Tools|HD 3 Accel

Includes:

- HD Core card
- Two HD Accel cards
- Pro Tools TDM software

### Pro Tools|HD 2

Includes:

- HD Core card
- HD Process card
- Pro Tools TDM software

## Pro Tools|HD 3

Includes:

- HD Core card
- Two HD Process cards
- Pro Tools TDM software

## MIX-Series Systems

### Pro Tools|24 MIX

Includes:

- MIX Core card
- Pro Tools TDM software

### Pro Tools|24 MIXplus

Includes:

- MIX Core card
- MIX Farm card
- Pro Tools TDM software

### Pro Tools|24 MIX<sup>3</sup>

Includes:

- MIX Core card
- Two MIX Farm cards
- Pro Tools TDM software

## Supported Audio Interfaces

### HD-Series Only

The following audio interfaces are compatible with Pro Tools|HD-series systems:

- 192 I/O
- 192 Digital I/O
- 96 I/O
- 96i I/O

**▲** *Pro Tools|HD-series systems require the use of at least one 192 I/O, 192 Digital I/O, 96 I/O, or 96i I/O.*

### HD-Series and MIX-Series

The following Digidesign audio interfaces are supported with Pro Tools|HD-series and Pro Tools|24 MIX-series systems:

- 888|24 I/O and 882|20 I/O
- 1622 I/O
- 24-bit ADAT Bridge I/O or original ADAT Bridge I/O

**▲** *Audio interfaces that work with HD-series systems require the use of at least one 192 I/O, 192 digital I/O, 96 I/O, or 96i I/O.*

The original 888 I/O and 882 I/O audio interfaces work with Pro Tools|24 MIX-series systems.

## TDM System Playback, Recording and Voice Limits

The following table lists the audio playback, recording, and voiceable track limits of each type of Pro Tools TDM system. Playback and recording voices refer to the number of unique simultaneous playback and record tracks on your system. Total voiceable tracks refers to the maximum number of audio tracks that can share the available voices on your system. (Mono tracks take up one voice. Stereo and multichannel tracks take up one voice per channel.) Voice limits are dependent on the session sample rate and the number of DSP chips dedicated to the system's Playback Engine. Pro Tools HD-series systems can open sessions with up to 256 audio tracks (and Pro Tools|24 MIX-series can open sessions with up to 128 audio tracks), but any audio tracks beyond that system's voiceable track limit will be automatically set to *Voice Off*.

Pro Tools|HD-series systems provide up to 128 Auxiliary tracks (Auxiliary Inputs); Pro Tools|24 MIX-series systems provide up to 64 Auxiliary Inputs. All TDM-equipped Pro Tools systems also provide a total of 64 internal mix busses, and up to 5 inserts and 5 sends per track (depending on the DSP capacity of your system). In addition, Pro Tools TDM systems support up to 256 MIDI tracks.

**Table 3. Pro Tools TDM system audio playback, recording and voice limits**

Core System Type	Sample Rate (kHz)	Voices (Mono Tracks of Simultaneous Playback)	Mono Tracks of Simultaneous Recording	Total Voiceable Tracks
Pro Tools HD 1	44.1/48	96	96	112
	88.2/96	48	48	48
	176.4/192	12	12	12
Pro Tools HD Accel 2, Pro Tools HD Accel 3	44.1/48	192	192	224
	88.2/96	96	96	80
	176.4/192	36	36	24
Expanded Pro Tools HD 1, Pro Tools HD 2, Pro Tools HD 3	44.1/48	128	128	224
	88.2/96	64	64	80
	176.4/192	24	24	24
Pro Tools 24 MIX, Expanded Pro Tools 24 MIX, Pro Tools 24 MIXplus, Pro Tools 24 MIX <sup>3</sup>	44.1/48	64	64	86

## Audio Interfaces for TDM Systems

Table 4 lists the input and output capabilities of the various audio interfaces for Pro Tools TDM systems. In expanded Pro Tools|HD systems, audio interfaces can be combined for up to 96 audio inputs and outputs (for example, with one HD Core card, two HD Accel or HD Process cards, and six I/Os). In expanded Pro Tools|24 MIX systems, audio interfaces can be combined for up to 72 audio inputs and outputs (for example, with one MIX Core card, five MIX Farm cards, and six ADAT Bridge I/Os).

*Table 4. Pro Tools TDM system audio interface channel capabilities*

Interface Type	Number of I/O Channels	Sample Rates (kHz)	A/D Conversion	D/A Conversion	Digital I/O
192 I/O	16 in/16 out	44.1, 48, 88.2, 96, 176.4, 192	24-bit	24-bit	24-bit
192 Digital I/O	16 in/16 out	44.1, 48, 88.2, 96, 176.4, 192	None	None	24-bit
96 I/O	16 in/16 out	44.1, 48, 88.2, 96	24-bit	24-bit	24-bit
96i I/O	16 in/2 out	44.1, 48, 88.2, 96	24-bit	24-bit	24-bit
888 24 I/O	8 in/8 out	44.1, 48	24-bit	24-bit (or 20-bit, on older I/O)	24-bit
882 20 I/O	8 in/8 out	44.1, 48	20-bit	20-bit	24-bit
1622 I/O	16 in/2 out	44.1, 48	20-bit	24-bit	24-bit
24-bit ADAT Bridge I/O	16 in/16 out	44.1, 48	None	24-bit	24-bit
Original ADAT Bridge I/O	16 in/16 out	44.1, 48	None	20-bit	24-bit (AES or S/PDIF), or 20-bit (Optical)
888 I/O	8 in/8 out	44.1, 48	18-bit (or 16-bit, on older I/O)	18-bit	24-bit
882 I/O	8 in/8 out	44.1, 48	16-bit	16-bit	24-bit



---

## Pro Tools LE Systems

Pro Tools LE-based systems are available in the following configurations:

### Digi 002

A Digi 002 system includes:

- Digi 002 combined audio interface and controller
- Pro Tools LE software

### Digi 002 Rack

A Digi 002 Rack system includes:

- Digi 002 audio interface
- Pro Tools LE software

### Digi 001

A Digi 001 system includes:

- Digi 001 PCI card
- Digi 001 I/O interface
- Pro Tools LE software

## Mbox

An Mbox system includes:

- Mbox audio interface
- Pro Tools LE software

**⚠** *The total processing capacity of a Pro Tools LE-based system depends on the processing power of your computer. Contact your Digidesign dealer or visit Digidesign's Web site for the latest system requirements and compatibility information.*

## Pro Tools LE System Capabilities

Table 5 lists the playback, recording, and input and output capabilities of each Pro Tools LE system. All Pro Tools LE systems support up to 32 or 24 audio tracks, as noted in Table 5. (Mono tracks take up a single audio track, while stereo tracks take up two tracks.) If you open a Pro Tools session created on a TDM system containing more than the number of tracks supported on the LE-based system, audio tracks beyond the LE system’s voiceable track limit will be automatically set to inactive (Pro Tools 6.x), or will not open (Pro Tools 5.3.3 or lower). Additionally, with 5.3.3 or lower, if you save the session, the tracks beyond the voiceable track limit will be deleted from the session data.

All Pro Tools LE series systems provide up to 128 Auxiliary tracks (Auxiliary Inputs), a total of 16 internal mix busses, and up to 5 inserts and 5 sends per track (depending on your computer’s processing capacity). In addition, Pro Tools LE systems support up to 256 MIDI tracks (Pro Tools 6.x).

**Table 5. Pro Tools LE system audio playback, recording, and channel capabilities**

System Type	Mono Tracks of Simultaneous Playback	Number of I/O Channels	A/D Conversion	D/A Conversion	Digital I/O
Digi 002 Digi 002 Rack	32	up to 18 in/18 out (48 kHz or lower)  up to 10 in/10 out (88.2 or 96 kHz)	24-bit	24-bit	24-bit
Digi 001	32 (Pro Tools 6.x cross-platform, and Pro Tools 5.3.1 to 6.x on Windows)  24 (Pro Tools 5.2 or lower)	up to 18 in/18 out	24-bit	24-bit	24-bit
Mbox	32 (Pro Tools 6.x cross-platform, and Pro Tools 5.3.3 to 6.x on Windows)  24 (Pro Tools 5.2)	up to 2 in/2 out	24-bit	24-bit	24-bit

For details on transferring session material between Pro Tools TDM and Pro Tools LE systems, see “Sharing Sessions Between Pro Tools TDM Systems and Pro Tools LE Systems” on page 53.

# Chapter 3: Pro Tools Concepts

This chapter explains the principles and concepts that form the foundation of Pro Tools operation and functionality.

---

## Hard Disk Audio Recording

Tape-based recording is a *linear* medium—you need to rewind or fast forward a tape to hear a particular spot in a recording. To rearrange or repeat material in a linear system, you need to re-record it.

Hard disk recording is a *nonlinear* (or random access) medium—you can go immediately to any spot in a recording without having to rewind or fast forward.

Nonlinear systems have several advantages. You can easily rearrange or repeat parts of a recording by making the hard disk read parts of the recording in a different order and/or multiple times. In addition, this re-arrangement is *non-destructive*, meaning that the original recorded material is not altered.

Pro Tools is a nonlinear recording system that lets you rearrange and mix recorded material nondestructively.

---

## The Digidesign Audio Engine

DAE (or Digidesign Audio Engine) is Digidesign's real-time operating system for digital recording systems. When you install Pro Tools, DAE is automatically installed on your system.

In the same way that a computer's operating system provides the foundation for programs that run on the computer, DAE provides the foundation for much of the hard disk recording, digital signal processing, mix automation, and MIDI functionality required by Pro Tools and other products from Digidesign and its Development Partners.

The DAE Playback Buffer Size determines the amount of memory allocated within DAE to manage disk buffers, which affects system performance. For more information, see "DAE Playback Buffer Size" on page 40. The DAE Playback Buffer Size can be changed in the Playback Engine dialog, discussed below.

## Playback Engine Dialog

Pro Tools takes advantage of your computer's host processor for certain tasks and optional host-based DSP processing.

Pro Tools LE uses host (CPU) processing to provide audio track recording, playback, mixing, and effects processing. Pro Tools TDM can also use host processing to run RTAS plug-ins for effects processing. Performance is determined by your system and its Playback Engine settings.

The Playback Engine dialog lets you set a hardware buffer size and allocate a percentage of CPU resources for these tasks. For more information, see “Configuring Pro Tools System Settings (in the Playback System Engine)” on page 37.

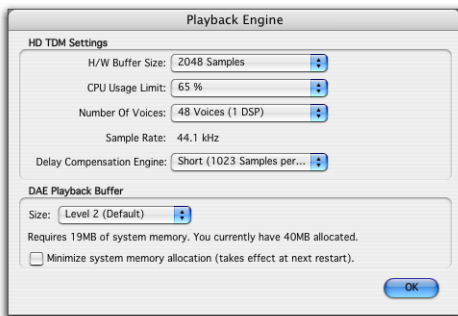

*Playback Engine dialog for Pro Tools TDM system*

From the Playback Engine dialog, you can also select the number of voices and voiceable tracks for your system and its sessions. Voice count choices in the dialog are based on how much DSP processing you want to allocate for voicing. For more information, see “Configuring Pro Tools System Settings (in the Playback System Engine)” on page 37.

 See also “System Resources” on page 16.

The Playback Engine dialog is also where you dedicate DSP resources for Delay Compensation.

---

## Pro Tools Sessions

When you start a project in Pro Tools, you create a *session*. Some basic elements of sessions are explained in this section.

### Session File



*Pro Tools session file icon, Pro Tools 6.x*

A *session file* is the document that Pro Tools creates when you start a new project. The session file contains maps of all elements associated with a project, including audio files, MIDI data, and all your edit and mix information. You can make changes to a session and save those changes in a new session file. This lets you create multiple versions of a project or back up your editing and mixing work.

### Audio File

When you record audio into a Pro Tools session, audio files are created.



*drmloop.wav*

*Audio file icon, Pro Tools 6.x*

Audio files for each session are stored in a folder named “Audio Files.” Audio files are listed in Pro Tools’ Audio Regions List and can appear in a track. A section of an audio file can be defined as a region. See “Regions (or Loops)” on page 13.

## Tracks

Pro Tools tracks are where audio, MIDI, and automation data are recorded and edited.

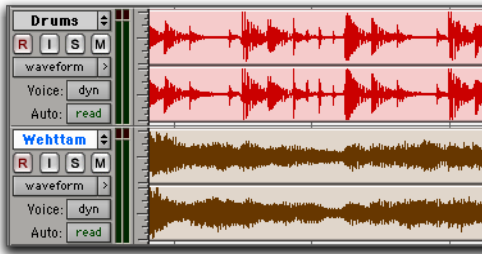

Audio tracks in the Edit window

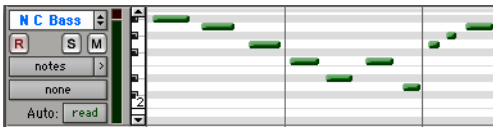

MIDI track in the Edit window

Audio and MIDI tracks can be edited into regions or repeated in different locations, to create loops, re-arrange sections or entire songs, or to assemble tracks using material from multiple takes.

Audio tracks can be mono, stereo, or any supported multichannel format (depending on your type of Pro Tools system). When creating a new audio track, you can choose from a list of formats supported by your system.

## Regions (or Loops)



Audio region

A *region* (or loop) is a piece of audio or MIDI data that may have associated automation data. A region could be a loop, a guitar riff, a verse of a song, a sound effect, a piece of dialog, or an entire sound file. In Pro Tools, regions are created from audio or MIDI files, and can be arranged in audio and MIDI track playlists.

## Playlist

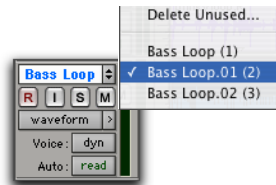

Playlist Selector pop-up menu

A *playlist* is a group of regions arranged on an audio or MIDI track. Tracks have *edit playlists* and *automation playlists*.

On audio tracks, an edit playlist tells the hard disk which audio files to read in what order. For example, you can use the same audio region to access the same piece of audio multiple times at different locations and not use additional disk space. Different versions of the same original audio can be used in different places and have different effects applied.

A playlist can be made up of a single region or many separate regions. It can be made up of similar elements, such as regions from several different takes of a solo, or dissimilar elements, such as several sound effects. You can create any number of edit playlists for a track. This lets you assemble different versions of performances or edits on a single audio or MIDI track and choose between them with a pop-up menu on the track.

Each track has a single set of automation playlists, for volume, pan, mute and each automation-enabled control for the insert and send assignments on that track.

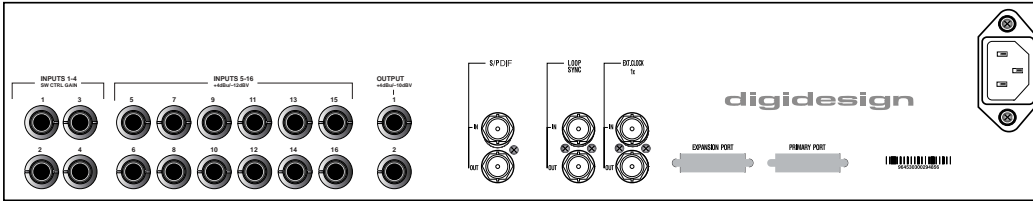

Figure 1. Back view of 96 I/O, with eight analog inputs, eight analog outputs, and eight digital input/output channels (using a lightpipe)

## Channel

The term *channel* is used to describe several related components of a Pro Tools system. The first example of channel refers to a physical input or output of your Pro Tools system.

For example, a 96 I/O audio interface (Figure 1) provides up to 16 channels of input and output to a Pro Tools|HD system. An 888|24 I/O audio interface provides eight channels of analog input and output to a Pro Tools TDM system.

The second use of the term *channel* refers to a mixer strip in the Pro Tools Mix window. The term *channel strip* refers to the mixer strip of any track (audio or MIDI track, Auxiliary Input, or Master Fader) in a session.

Audio and MIDI channel strips have similar controls, but those controls have slightly different effects. For example, audio and Auxiliary Input channel strip faders control the output gain to the mix bus for that channel, while MIDI channel strip faders send MIDI volume data (MIDI controller 7) to the MIDI instrument.



Figure 2. Channel strip in the Mix window

 The term *channel* also describes a separate aspect of MIDI operation. See “MIDI Concepts” on page 19.



**Auxiliary Inputs and Master Faders** Auxiliary Inputs are tracks that can be used as returns, sub-mixers and bus masters. Master Faders are used as bus and output master level controls. Both Auxiliary Inputs and Master Faders can have plug-in and/or hardware inserts.

**Sends** Sends route audio to internal busses to send to other tracks in Pro Tools, or to hardware outputs. Master Faders do not have sends.

**Plug-In and Hardware Inserts** Software plug-ins and hardware inserts process the audio on their associated track. Plug-in processing occurs completely within the Pro Tools system. Hardware inserts utilize audio interface inputs and outputs, for traditional insert routing to (and from) external effects and other devices.

**Paths** Pro Tools lets you define any internal or external input, output, bus, or insert with a single name and format (mono, stereo, or multichannel). Paths comprise the lists of available routing choices in track I/O Selectors and other menus. Paths are auto-named by default, but can be customized in the I/O Setup window. See Chapter 7, “I/O Setup” for more information.

**Mixing Formats** Sessions can include combinations of mono, stereo, and multichannel format tracks, busses, inputs, outputs, and inserts. (Multichannel formats are supported on Pro Tools HD-series and MIX-series systems only.)

---

## System Resources

Track count, plug-in processing, signal path and routing options, and voice availability are ultimately limited by the combined resources available from the host computer, and from your Pro Tools hardware.

Pro Tools provides several ways to manage and conserve resources to maximize the performance of your system. As you begin working with Pro Tools sessions and tracks, you can take advantage of the following features to extend the effectiveness of your available DSP and other resources:

- ◆ Pro Tools lets you adjust the performance of your system by changing system settings (such as H/W Buffer Size and CPU Usage) that affect its capacity for processing, playback, and recording. See “Configuring Pro Tools System Settings (in the Playback System Engine)” on page 37.
- ◆ Pro Tools allows for session items (such as tracks and inserts) to be manually made inactive, to free up DSP resources. Inactive elements are viewable, editable, and retained within the session. See “Active and Inactive Items” on page 17.
- ◆ All Pro Tools TDM systems, as well as LE systems (Pro Tools 6.x only), provide flexible voice options for audio tracks, to help maximize use of available voices in your system. For more information on voice management and options, see “Voiceable Tracks and Track Priority” on page 98.



## Active and Inactive Items

Pro Tools lets you set certain items (such as tracks and inserts) as *inactive*, in order to free up DSP resources and mixer connections.

Items in Pro Tools that can be made inactive (or active) include the following:

- Audio tracks, Auxiliary Inputs, and Master Faders
- Track Inputs and Outputs
- Sends
- Side-chain inputs
- Plug-ins
- Hardware inserts
- Paths (session-wide)



*MIDI tracks cannot be made inactive.*

In addition to manually setting Active and Inactive modes, Pro Tools will automatically make items inactive if there are insufficient or unavailable resources.

When *active*, items are fully engaged and operational.

When *inactive*, items are silent and off, although most associated controls can still be adjusted. Different inactive items affect available system resources in specific ways, as follows:

**Plug-Ins** When a plug-in is inactive on a track, its DSP is made available for other plug-ins and processing. Plug-in assignments can be made inactive manually, or automatically (see “Automatic and Manual Inactive Mode” on page 18).

**Paths and Path Assignments** When a path or path assignment is inactive, its mixer resources are made available for other signal routing purposes in the session. Paths and assignments can be made inactive manually, or automatically (see “Automatic and Manual Inactive Mode” on page 18).

**Tracks** For TDM systems (Pro Tools 5.1 and higher) and LE systems (Pro Tools 6.x), when a track is made inactive, its voices become available for another track. Mono inactive tracks free up one voice, and stereo and multichannel tracks free up one voice per channel. Additionally, when an audio track, Auxiliary Input, or Master Fader is made inactive, its plug-ins, inserts, sends, and I/O assignments become inactive, and the associated DSP used is freed up for use elsewhere in the session.

## Display of Inactive Items

When items are inactive, their names appear in *italics*, and their background becomes dark grey. When a track is inactive, the entire channel strip is grayed out.

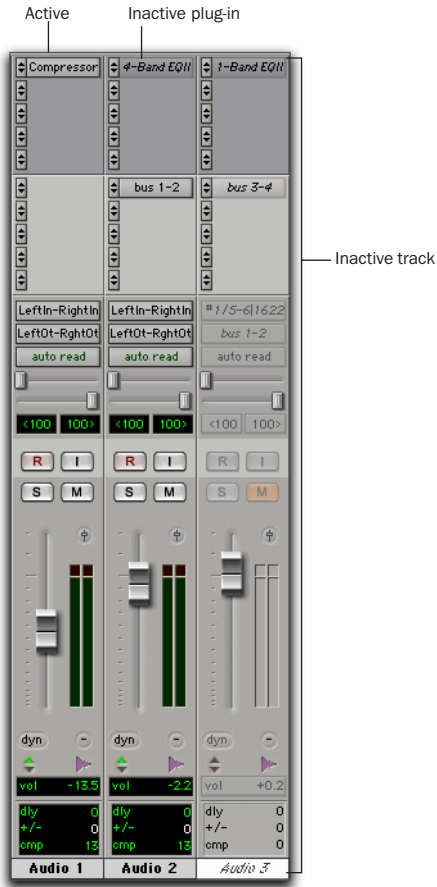

Active and inactive items and tracks

## Automatic and Manual Inactive Mode

Active and Inactive modes are powerful options for session transfer, and system resource management. Pro Tools provides automatic and manual Inactive mode switching. You can manually make items inactive (or active) to selectively manage system resources while editing and mixing.

### Automatically Inactive Items

When opening a session, it is possible that not all signal paths, plug-ins, or audio interfaces used in the session will be available as defined on the current system. When opening a session, sufficient voices may also be unavailable if the session was created on a different Pro Tools system type (for example, creating a session on a Pro Tools|24 MIX-series system, then opening it in on a Pro Tools|HD-series system).

Whenever this occurs, the session will open as it was last saved. All items that are unavailable, or cannot be loaded due to insufficient resources, are made inactive.

### Manual Inactive Switching

You can manually apply Active or Inactive modes to manage system resources. By making an item inactive, its associated resources are made available elsewhere in the session.

The following are basic instructions for manually making items inactive. Throughout the *Pro Tools Reference Guide*, instructions are provided whenever an item can be made inactive.

#### To toggle an item active or inactive:

- Control-Start-click (Windows) or Command-Control-click (Macintosh) the item.

You can apply Active or Inactive modes to all or all selected tracks using standard Pro Tools modifiers (Alt and Alt+Shift in Windows, Option and Option+Shift on the Macintosh). Side-chain inputs support direct active and inactive switching, but do not follow switching all or all selected side-chain inputs.

---

## MIDI Concepts

MIDI (Musical Instrument Digital Interface) is a communication protocol for musical instruments. This industry standard enables connections between a variety of devices from different manufacturers. Examples of MIDI-compatible equipment include synthesizers, sound modules, drum machines, patch bays, effects processors, MIDI interfaces, and sequencers.

MIDI devices are equipped with 5-pin DIN connectors, labeled as either IN, OUT, or THRU.

The MIDI OUT port transmits messages; the MIDI IN port receives messages; and, MIDI THRU echoes whatever is received from the IN port. MIDI devices are connected with MIDI cables that are available at most music stores.

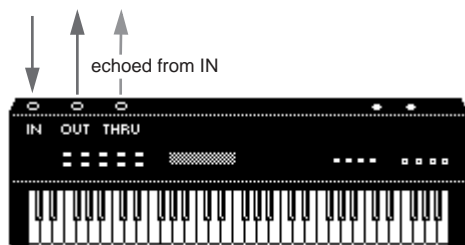

MIDI signal flow

⚠ *Not all devices will have all three MIDI ports (IN, OUT and THRU).*

A single MIDI cable can transmit a separate set of messages for each of the 16 channels. These 16 channels correspond to separate MIDI devices or to multiple channels within a single device (if the device is *multi-timbral*). Each channel represents a discreet instrument sound; for instance, bass on channel 1, piano on channel 2, and drums on channel 10. Similar to a multi-track tape recorder, a MIDI sequencer can record complex arrangements—even using a single multi-timbral keyboard.

## MIDI Terms

The following are some basic MIDI terms:

**MIDI Interface** Hardware that lets computers connect to and communicate with MIDI devices.

**MIDI Device** Any keyboard, sound module, effects device or other equipment that can send or receive MIDI information.

**MIDI Controller** Any MIDI device that transmits MIDI performance data. These include keyboards, MIDI guitar controllers, MIDI wind instruments, and others. Controllers transmit MIDI from their MIDI OUT ports.

**MIDI Control Surface** Any device (such as the Digidesign Command|8), which uses a MIDI connection to send control messages to a software program, but is not generally used to record MIDI information.

**MIDI Sound Source** Any MIDI instrument capable of playing back MIDI-triggered sound. Sound sources receive MIDI from their MIDI IN ports.

**Multi-Timbral** The capability of playing several different instrument sounds (such as piano, bass, and drums) simultaneously on separate channels. This makes it possible for a single MIDI sound source to play back entire arrangements.

**MIDI Channel** Up to 16 channels of MIDI performance data can be transmitted on a single MIDI cable. The channel number separates the different messages so your sound sources can receive the right ones.

**Program Change Event** A MIDI command that tells a sound source which of its sounds (or sound patches) to use. The MIDI protocol lets you choose from a range of 128 patches.

**Bank Select Message** Many devices have more than 128 patches, which are arranged in banks. The Bank Select Message is a MIDI command that specifies the bank of patches from which to choose.

**Local Control** A controller setting found on most MIDI keyboards that lets them play their own sound source. Disabling “local control” ensures that a device’s internal sound source is only played by external MIDI messages.

When using Pro Tools, “local control” should usually be disabled. When “local control” is off, your keyboard still transmits data to its MIDI OUT port.

**Continuous Controller Events** MIDI instructions that allow real-time changes to notes that are currently sounding. These include pitch bend, modulation, volume, pan, and many others.

**System Exclusive Data** MIDI data commonly used for sending and retrieving patch parameter information for storage purposes.

## Common Misconceptions about MIDI

MIDI is not audio. The messages that travel down a MIDI cable translate to specific instructions. For instance, when you strike a key on your MIDI keyboard it sends a message to its MIDI OUT port telling another device (if connected and set to the same MIDI channel) to play that particular note.

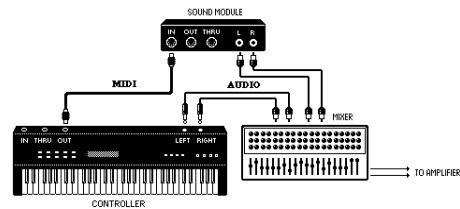

### Signal paths for MIDI instruments

However, to actually hear that second device (sound source) you’ll need to connect its audio outputs to a sound system. Your MIDI instruments have two signal paths, one for audio and another for MIDI.

MIDI does not allow you to use your devices beyond their capabilities. Particular instruments have their own sound generation, polyphony, and multi-timbral limitations.

# Chapter 4: Pro Tools Windows

Pro Tools provides two complementary ways of viewing a session: the Mix window and the Edit window. Pro Tools also lets you control the transport and transport-related functions from the Transport window.

For information on the main elements of the Mix window and Edit window, see the page references provided in Figure 3 on page 22, and Figure 4 on page 23.

---

## The Mix Window

In the Mix window, tracks appear as mixer strips (or channel strips), with controls for inserts, sends, input and output assignments, volume, panning, record enable, automation mode, and solo/mute. The following section explains each of these track controls.

To display the Pro Tools comments, inserts, sends, and Automatic Delay Compensation, select **Display > Mix Window Shows > All**. You can choose to display all of these items, or some of them.

 *To toggle between the Mix and Edit windows: On Windows, press **Control+Equals** (=); On Macintosh, press **Command+Equals** (=).*

---

## The Edit Window

The Edit window provides a timeline display of audio, as well as MIDI data and mixer automation for recording, editing and arranging tracks. As in the Mix window, each track has controls for record enable, solo, mute and automation mode.

Systems with Pro Tools AVOption|V10 installed also provide a timeline display of the movie track.

To display the input/output controls, inserts, sends, and comments in the Edit window, select **Display > Edit Window Shows > All**. You can choose to display all of these items, or some of them.

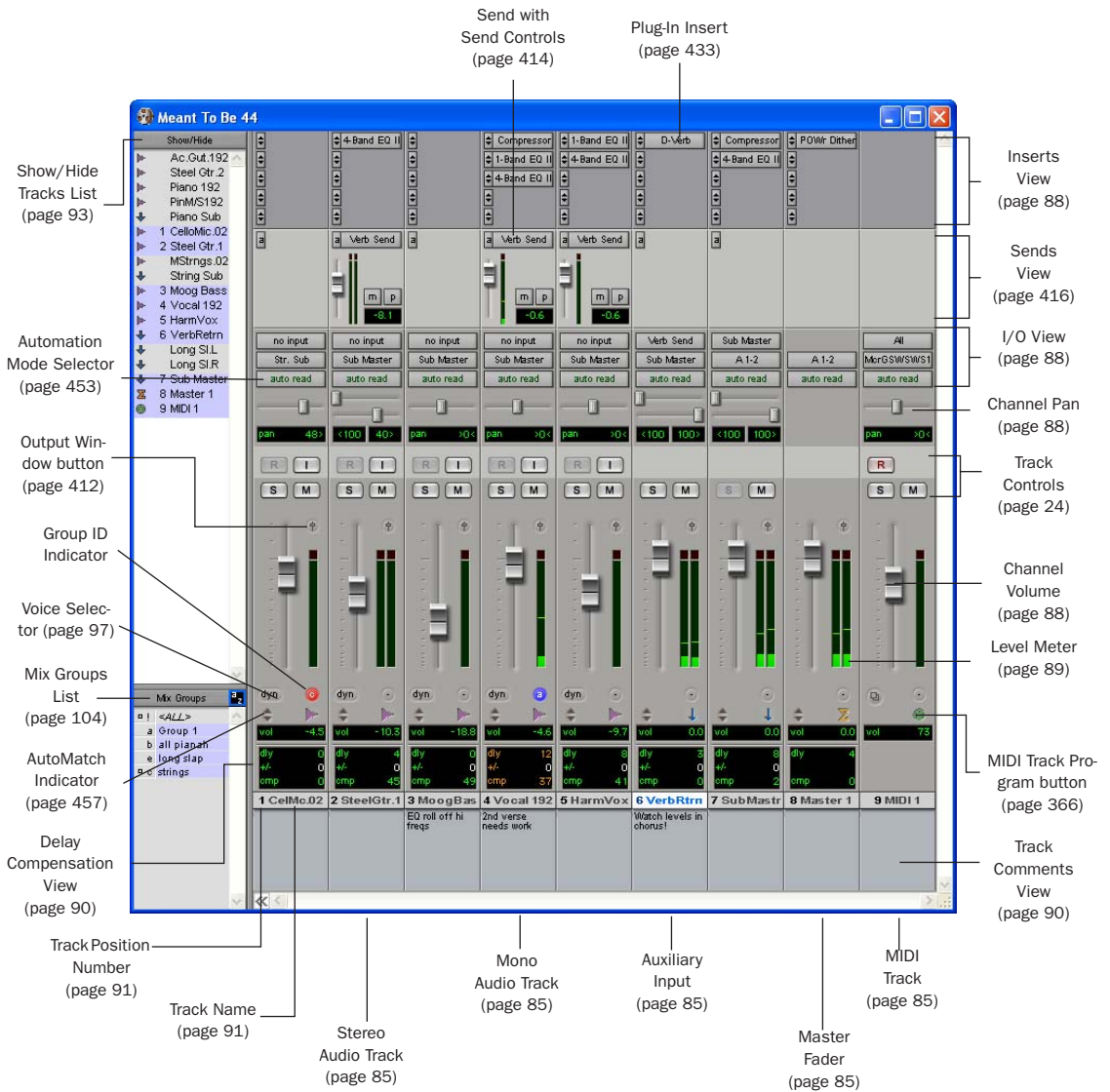

Figure 3. Pro Tools Mix window (Pro Tools 6.4)

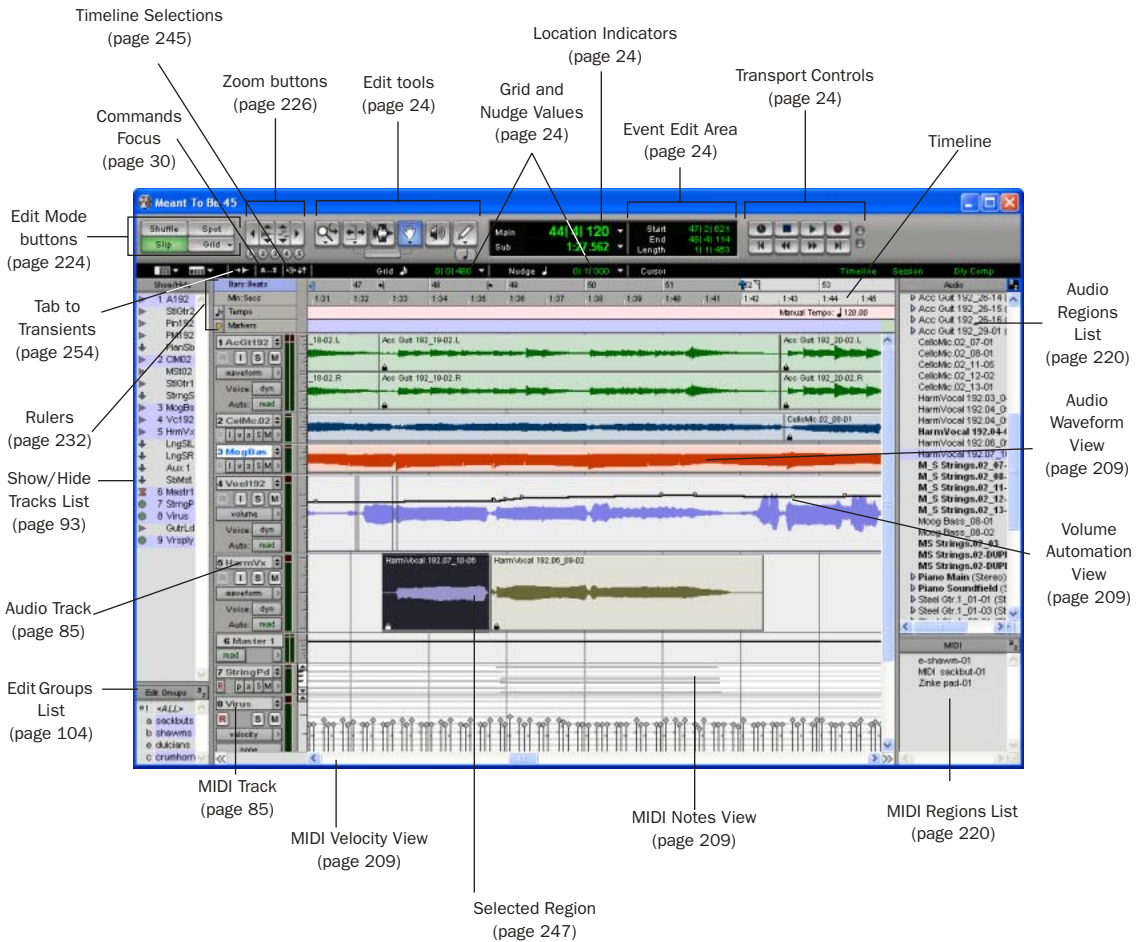
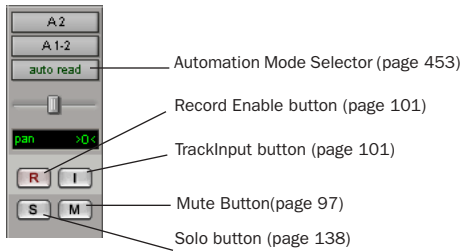
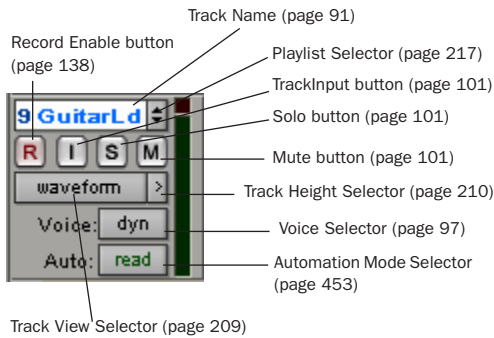

Figure 4. Pro Tools Edit window (Pro Tools 6.4)

## Track Controls



Mix window controls for audio and MIDI tracks, wide view (Pro Tools 6.4)



Edit window track controls, medium track height (Pro Tools 6.4)

## Edit Tools

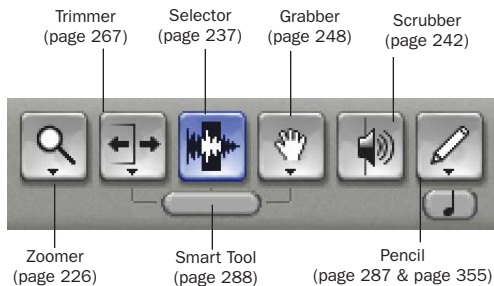

Edit tools in Edit window

## Event Edit Area

The Event Edit Area provides time, pitch, and other information for the currently selected audio or MIDI data. It also lets you define selections using a key entry.

The Start, End, and Length display can be set for a different Time Scale format (such as Samples, Bars:Beats, or Minutes:Seconds). For more information, see “Main Time Scale” on page 233.

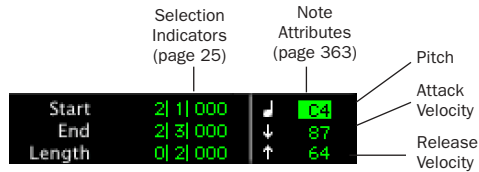

Event Edit Area showing MIDI track information

## Location Indicators, Grid/Nudge Values, Current Cursor Display

The Location Indicators, Grid and Nudge values, and timeline Cursor Location display provide navigation and editing options.

The Main and Sub display can be set for a different Time Scale format (such as Samples, Bars:Beats, or Minutes:Seconds). For more information, see “Main Time Scale” on page 233.

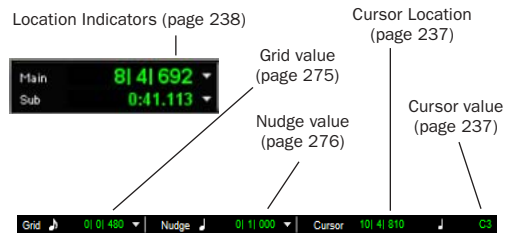

Edit window display showing MIDI track information



## The Transport Window

The Transport window can be set to show basic transport controls, counters, and MIDI controls. The counters in the Transport window mirror the Location Indicators at the top of the Edit window.

### Basic Transport Controls and Counters

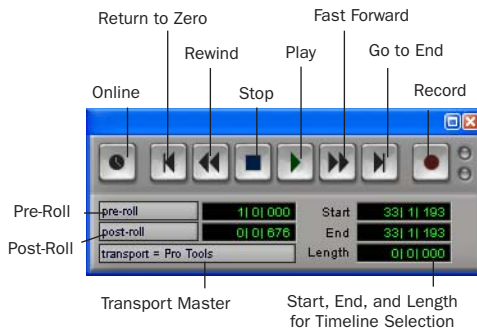

*Transport window showing basic transport controls and counters (Pro Tools 6.4)*

**Online** Puts Pro Tools online so that playback and recording is triggered by an external time code source.

**Return to Zero** Locates to the beginning of the session.

**Rewind** Rewinds from the current play location. You can also click repeatedly to rewind incrementally, by an amount based on the Main Time Scale, as follows:

#### Rewind Increments

Main Time Scale Format	Increment Amount
Min:Sec	1 second
Time code (Pro Tools TDM or DV Toolkit for Pro Tools LE)	1 frame
Bars:Beats	1 bar
Feet+Frame (Pro Tools TDM or DV Toolkit for Pro Tools LE)	1 foot
Sample	1 second

 *With the Numeric Keypad Mode set to Transport, you can rewind by pressing 1.*

**Stop** Stops playback or recording.

You can also stop the Transport with the following shortcuts:

- Press the Spacebar.
- With the Numeric Keypad Mode set to Transport, press 0.

**Play** Starts playback or (if the Record button was clicked first) recording from the Timeline insertion point.

With the Transport stopped, Right-click Play (Windows) or Control-click Play (Macintosh) to toggle Loop Playback mode. When enabled, a loop symbol appears in the Play button.

You can also initiate playback with the following shortcuts:

- Press the Spacebar.
- With the Numeric Keypad Mode set to Transport, press 0.

You can play at half-speed with the following shortcuts:

- Press Shift+Spacebar.
- Shift-click (Macintosh) the Play button.

**Fast Forward** Fast forwards from the Timeline insertion point. You can also click repeatedly to fast forward incrementally (by an amount based on the Main Time Scale).

#### Fast Forward Increments

Main Time Scale Format	Increment Amount
Min:Sec	1 second
Time code (Pro Tools TDM or DV Toolkit for Pro Tools LE)	1 frame
Bars:Beats	1 bar
Feet+Frame (Pro Tools TDM or DV Toolkit for Pro Tools LE)	1 foot
Sample	1 second

 *With the Numeric Keypad Mode set to Transport, you can fast forward by pressing 2.*

**Go to End** Locates to the end of the session.

 *You can press Control+Enter on the alpha keyboard (Windows) or Option+Return (Macintosh) to locate to the end of the session.*

**Record** Arms Pro Tools for recording (the button flashes). Clicking Play then initiates recording.

With the Transport stopped, Right-click Record (Windows) or Control-click Record (Macintosh) to cycle through the four record modes. The Record button changes to indicate the currently selected mode: blank for Nondestructive, “D” for Destructive, a loop symbol for Loop Record, and “P” for QuickPunch.

You can also begin recording with the following shortcuts:

- Press F12.
- Control+Spacebar (Windows) or press Command+Spacebar (Macintosh).
- With the Numeric Keypad Mode set to Transport, press 3.

 *To initiate recording at half-speed, press Control+Shift+Spacebar (Windows) or Command+Shift+Spacebar (Macintosh).*

**Pre-Roll** During playback or record, specifies the amount that plays before the play (timeline) cursor location or beginning of the timeline selection. Pre-roll is particularly useful with punch recording since it provides you with time to “catch the beat” before reaching the punch-in point. To set the pre-roll amount, enter a new value in this field, or drag the Pre-Roll flag in the Main Timebase Ruler.

To enable pre-roll, click the Pre-Roll button to the left of the pre-roll field so it becomes highlighted.

**Post-Roll** During playback or record, specifies the amount that plays after the end of a timeline selection. Post-roll is useful in punch recording since playback continues after the punch-out point so you can check for a smooth transition

to previously recorded material. To set the post-roll amount, enter a new value in this field, or drag the Post-Roll flag in the Main Timebase Ruler.

To enable post-roll, click the Post-Roll button to the left of the post-roll field so it becomes highlighted.

**Start** Specifies the beginning of the play or record range. You can set the start point by entering a location in this field, or by dragging the corresponding Playback Marker in the Main Timebase Ruler. For more information, see “Playback Markers” on page 168.

**End** Specifies the end of the play or record range. You can set the end point by entering a location in this field, or by dragging the corresponding Playback Marker in the Main Timebase Ruler. For more information, see “Playback Markers” on page 168.

**Length** Specifies the length for the play or record range. You can set the length by entering a location in this field, or by selecting a range in any Timebase Ruler.

 *When the Edit and Timeline selections are linked, you can drag in a track’s playlist to set the play and record range. See “Linking or Unlinking Edit and Timeline Selections” on page 245*

**Transport Master** Specifies the “master” for transport functions. Click this button and choose from the pop-up menu to select the Transport Master, which can be set to Pro Tools, Machine, MMC, or Remote. For information, see Chapter 35, “Working with Synchronization.”

## MIDI Controls

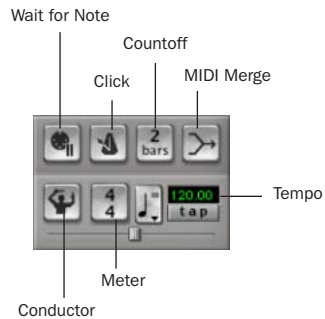

**Transport window showing MIDI controls**

**Wait for Note** When selected, recording does not begin until a MIDI event is received. This ensures that you begin recording when you’re ready to play, and that the first note, or other MIDI data, is recorded precisely at the beginning of the record range.

 *You can press F11 to turn on Wait for Note, unless the Operation Preference for “Disable F11 for Wait for Note” is selected.*

**Click** When selected, a metronome sounds during playback and recording (as specified by the settings in the Click/Countoff Options dialog).

Double-click the Click button to open the Click/Countoff Options dialog.

 *With the Numeric Keypad Mode set to Transport, you can press 7 to enable the Click.*

**Countoff** When selected, Pro Tools counts off a specified number of measures (indicated in the button) before playback or recording begins.

Double-click the Countoff button, to open the Click/Countoff Options dialog.



*With the Numeric Keypad Mode set to Transport, you can press 8 to enable the Countoff.*

**MIDI Merge** When selected (Merge mode), recorded MIDI data is merged with existing track material. When deselected (Replace mode), recorded MIDI data replaces existing track material.



*With the Numeric Keypad Mode set to Transport, you can press 9 to enable MIDI Merge.*

**Conductor** When selected, Pro Tools uses the tempo map defined in the Tempo Ruler. When deselected, Pro Tools switches to Manual Tempo mode and ignores the Tempo Track.

In Manual Tempo mode, you can enter a BPM value in the tempo field, or tap in the tempo by clicking the Tap button.

**Meter** Displays the session's current meter based on the play location. Double-click the Meter button to open the Change Meter window.

**Tempo** Displays the session's current tempo based on the play location. In Manual Tempo mode, you can enter a BPM value into this field. In addition, when the tempo field is selected, you can tap in a tempo from a MIDI controller.

# Chapter 5: Keyboard Shortcuts

## Global Key Commands

This section shows keyboard shortcuts that apply to many functions in Pro Tools.

### Track Functions

- Changing Automation mode
- Enabling playlists
- Adding plug-ins
- Record enabling, soloing, and muting tracks
- Record safing and solo safing tracks
- Assigning inputs, outputs, and sends
- Toggling volume/peak/delay display
- Clearing meters
- Changing track heights

Command	Windows	Macintosh
Apply action to all channel strips/tracks	Alt+ action	Option+ action
Apply action to selected channel strips/tracks	Alt+ Shift+ action	Option+ Shift+ action

### List and Parameter Selection

- Selection of tracks in Show/Hide List
- Enabling of groups in Groups List
- Automation Enable window parameters
- Setting memory location parameters

Command	Windows	Macintosh
Toggle item and set all others to same new state	Alt-click item	Option-click item
Toggle item and set all others to opposite state	Control-click item	Command-click item

### Controls and Editing Tools

- ◆ Use to move plug-in controls, faders and sliders, the Scrubber, and automation data

Command	Windows	Macintosh
Fine adjustment of sliders, knobs, and breakpoints	Control-click item	Command-click item

## Keyboard Focus

The Keyboard Focus in Pro Tools determines how the alpha keys function. Depending on which Keyboard Focus is enabled, you can use the keys on your alpha keyboard to select regions in the Audio or MIDI Regions List, enable or disable groups, or perform an edit or play command.

You can only enable one Keyboard Focus at a time. Enabling a Keyboard Focus will disable the one previously enabled.

There are four types of Keyboard Focus:

**Commands Focus (All TDM Systems and Pro Tools LE 6.1 or Higher Only)** When selected, this provides a wide range of single key shortcuts from the alpha keyboard for editing and playing.

With Commands Focus disabled, you can still access any of its key shortcuts by pressing the Start key (Windows) or Control (Macintosh) along with the key.

**Audio Regions List Focus** When selected, audio regions can be located and selected in the Audio Regions List by typing the first few letters of the region's name.

**MIDI Regions List Focus** When selected, MIDI regions can be located and selected in the MIDI Regions List by typing the first few letters of the region's name.

**Groups List Focus** When selected, Edit and Mix Groups can be enabled or disabled by typing the Group ID letter.

 *An electronic PDF listing of keyboard shortcuts is available in Pro Tools. Choose Help > Keyboard Shortcuts.*

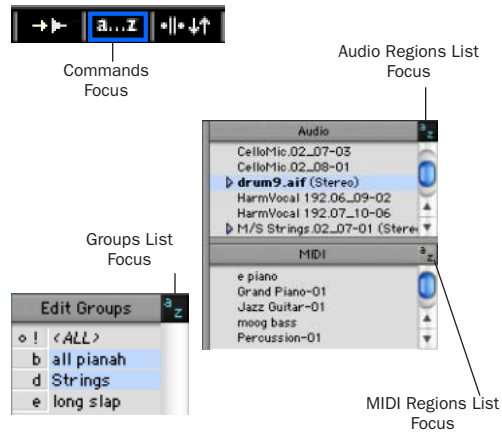

### Keyboard Focus buttons

#### To set the Keyboard Focus:

- Click the a-z button for the focus you want to enable.
  - or –
- While pressing Control+Alt (Windows) or Command+Option (Macintosh), press one of the following keys: 1 (Commands), 2 (Audio Regions List), 3 (MIDI Regions List), or 4 (Groups List).

---

## Numeric Keypad Modes

The Operation preference for Numeric Keypad Mode determines how the numeric keypad functions for Transport.

There are two Shuttle Lock modes (Classic and Transport), and one Shuttle mode.

No matter which Numeric Keypad Mode is selected, you can always use the numeric keypad to select and enter values in the Event Edit Area, Location Indicators, and Transport fields.

### To set the Numeric Keypad Mode:

- 1 Choose Setups > Preferences and click Operation.
- 2 Under the option for Numeric Keypad Mode, select a keypad mode (Classic, Transport, or Shuttle), then click Done.

## Shuttle Lock Modes

With either Shuttle Lock mode (Classic or Transport) you can use the numeric keypad to shuttle forward or backwards at specific speeds: 5 is normal speed, 6–9 provide increasingly faster fast-forward speeds, and 1–4 provide progressively faster rewind speeds (4 is the slowest rewind Shuttle Lock speed, 1 is the fastest).

### Custom Shuttle Lock Speed

The highest fast-forward Shuttle Lock speed (key 9) can be customized (Pro Tool 6.2 and higher on Pro Tools|HD systems and DV Toolkit for Pro Tools LE only). See “Custom Shuttle Lock Speed” on page 244.

## Classic Mode

This mode emulates the way Pro Tools worked in versions lower than 5.0. With the Numeric Keypad Mode set to Classic, you can:

- Play up to two tracks of audio in Shuttle Lock mode. Press the Start key (Windows) or Control (Macintosh), followed by 0–9 for different play speeds. Press Plus or Minus to reverse direction.

Playback Speeds	Key
1x Forward	6
1x Rewind	4
4x Forward	9
4x Rewind	7
1/4x Forward	3
1/4x Rewind	1
1/2x Forward	5+6
1/2x Rewind	5+4
2x Forward	8+9
2x Rewind	8+7
1/16x Forward	2+3
1/16x Rewind	2+1
Loop Selection (1x)	0

- Recall Memory Locations by typing the Memory Location, followed by a period.

## Transport Mode

This mode allows you to set a number of record and play functions, and also operate the Transport from the numeric keypad.

Function	Key
Click on/off	7
Countoff on/off	8
MIDI Merge/Replace mode	9
Loop Playback mode on/off	4
Loop Record mode on/off	5
QuickPunch mode on/off	6
Rewind	1
Fast Forward	2
Record	3
Play/Stop	0

With the Numeric Keypad Mode set to Transport, you can also:

- Play up to two tracks of audio in Shuttle Lock mode. Press the Start key (Windows) or Control (Macintosh), followed by 0–9 for different play speeds. Press Plus or Minus to reverse direction.

Playback Speeds	Key
1x Forward	6
1x Rewind	4
4x Forward	9
4x Rewind	7
1/4x Forward	3
1/4x Rewind	1
1/2x Forward	5+6
1/2x Rewind	5+4
2x Forward	8+9
2x Rewind	8+7
1/16x Forward	2+3
1/16x Rewind	2+1
Loop Selection (1x)	0

- Recall Memory Locations by typing period, the Memory Location number, and period again.



## Shuttle Mode

### (TDM Systems Only)

Pro Tools offers another form of shuttling, different from that of the two Shuttle Lock modes. With the Numeric Keypad Mode set to Shuttle, playback of the current Edit selection is triggered by pressing and holding the keys on the numeric keypad—playback stops once the keys are released. Various playback speeds are available in both forward and reverse. In this mode, pre- and post-roll are ignored.

Playback Speeds	Key
1x Forward	6
1x Rewind	4
4x Forward	9
4x Rewind	7
1/4x Forward	3
1/4x Rewind	1
1/2x Forward	5+6
1/2x Rewind	5+4
2x Forward	8+9
2x Rewind	8+7
1/16x Forward	2+3
1/16x Rewind	2+1
Loop Selection (1x)	0

With the Numeric Keypad Mode set to Shuttle, you can also:

- Recall Memory Locations by typing period, the Memory Location number, and period again.

**⚠** *Shuttle Lock modes are not available when the Numeric Keypad Mode is set to Shuttle.*



# **Part II: Sessions & Tracks**



# Chapter 6: Sessions

This chapter covers the basics of starting a project in Pro Tools, including how to set up and save a Pro Tools session.

---

## Starting Up or Shutting Down Your System

To ensure that the components of your Pro Tools system communicate properly with each other, you need to start them in a particular order.

### Start up your Pro Tools system in this order:

- 1 For TDM systems with an expansion chassis, turn on the chassis.
- 2 Turn on any external hard drives. Wait approximately ten seconds for them to spin up to speed.
- 3 Turn on any MIDI interfaces, MIDI devices, or synchronization peripherals.
- 4 Lower the volume of all output devices in your system.
- 5 For TDM systems, turn on your Pro Tools audio interfaces. Wait at least fifteen seconds for your system hardware to initialize.
- 6 Turn on your computer.
- 7 Launch Pro Tools or any third-party audio or MIDI applications.

### Shut down your Pro Tools system in this order:

- 1 Quit Pro Tools and any other running applications.
- 2 Turn off or lower the volume of all output devices in your system.
- 3 Turn off your computer.
- 4 For TDM systems, turn off audio interfaces.
- 5 For TDM systems with an expansion chassis, turn off the chassis.
- 6 Turn off any MIDI interfaces, MIDI devices, or synchronization peripherals.
- 7 Turn off any external hard drives.

---

## Configuring Pro Tools System Settings (in the Playback System Engine)

Pro Tools allows you to adjust the performance of your system by changing *system settings* that affect its capacity for processing, playback, and recording.

These system settings are changed in the Playback Engine Dialog (Setups > Playback Engine).

In most cases, the default settings for your system provide optimum performance, but you may want to adjust them to accommodate large or processing-intensive Pro Tools sessions.

## Hardware Buffer Size

The Hardware Buffer Size (H/W Buffer Size) controls the size of the hardware cache used to handle host-based tasks such as Real-Time Audio Suite (RTAS) plug-in processing.

- ◆ Lower Hardware Buffer Size settings reduce monitoring latency, and are useful when you are recording live input.
- ◆ Higher Hardware Buffer Size settings allow for more audio processing and effects, and are useful when you are mixing and using more RTAS plug-ins.

**⚠** *In addition to causing slower screen response and monitoring latency, higher Hardware Buffer Size settings can affect the accuracy of plug-in automation, mute data, and timing for MIDI tracks.*

### To change the Hardware Buffer Size:

- 1 Choose Setups > Playback Engine.
- 2 From the H/W Buffer Size pop-up menu, select the audio buffer size, in samples.
- 3 Click OK.

## CPU Usage Limit

The CPU Usage Limit controls the percentage of CPU resources allocated to Pro Tools host processing tasks.

- ◆ Lower CPU Usage Limit settings limit the effect of Pro Tools processing on other CPU-intensive tasks, such as screen redraws, and are useful when you are experiencing slow system response, or when running other applications at the same time as Pro Tools.
- ◆ Higher CPU Usage Limit settings allocate more processing power to Pro Tools, and are useful for playing back large sessions or using more real-time plug-ins.

With Pro Tools 6.x, the maximum CPU Usage Limit is 85 percent for single-processor computers (except for Digi 002, which has a limit of 99 percent), and 99 percent for multi-processor computers. (The 99 percent setting dedicates one entire processor to Pro Tools.)

**⚠** *Increasing the CPU Usage Limit may slow down screen responses on slower computers.*

### To change the CPU Usage Limit:

- 1 Choose Setups > Playback Engine.
- 2 From the CPU Usage Limit pop-up menu, select the percentage of CPU processing you want to allocate to Pro Tools.
- 3 Click OK.

## Number of Voices

### (TDM Systems Only)

On TDM systems, the Number of Voices setting lets you control the number of available voices and how those voices are allocated to DSPs in your system. For example, the default number of voices on a Pro Tools|HD 1 system is 48 voices, using one DSP (at sample rates of 44.1 kHz or 48 kHz).

**⚠** *Changing the number of voices affects DSP usage, the total number of voiceable tracks, and overall system performance.*

Depending on the current sample rate and the number of TDM cards in your system, you will have different choices for voice count. For voice limits on different Pro Tools|HD systems, see “TDM System Playback, Recording and Voice Limits” on page 7.

**To change the number of voices and DSP to allocate for voicing:**

- 1 Choose Setups > Playback Engine.

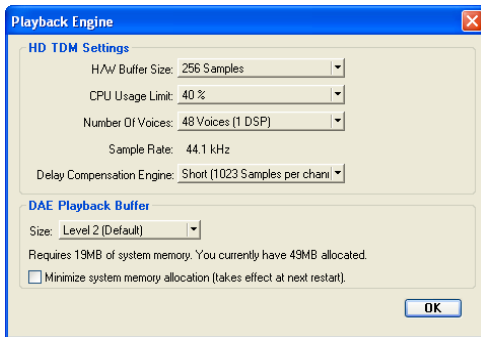

*Playback Engine dialog (Pro Tools 6.4)*

- 2 Select the number of voices and DSPs to allocate for voicing by selecting a value from the Number of Voices pop-up menu.

- Select higher voice numbers when your Digidesign cards are the only PCI cards in your computer, or when you are using an expansion chassis to run higher track counts.
- Select medium voice numbers when your Digidesign cards are in an expansion chassis, or when you are using other PCI cards along with Digidesign cards.
- Select minimum voice numbers if you are using high-bandwidth PCI cards (such as video capture cards) along with your Digidesign cards. In addition, to free up DSP for plug-ins and processing, select the minimum number of voices and DSPs needed to play back the current session.

- 3 Click OK.

## Default Sample Rate

The Sample Rate setting appears as the default sample rate when you create a new session. (This setting is available only when there is no session open.)

**⚠** *The Sample Rate setting can affect the number of available voices on TDM systems.*

### To change the default Sample Rate:

- 1 Choose Setups > Playback Engine.
- 2 Select the sample rate from the Sample Rate pop-up menu.
- 3 Click OK.

**📖** *You can change the sample rate when creating a new Pro Tools session by selecting a different sample rate in the New Session dialog. (See “Creating a New Session” on page 45.)*

## Delay Compensation Engine

(Pro Tools 6.4 for Pro Tools|HD Systems Only)

The Delay Compensation Engine lets you enable Delay Compensation for managing DSP delays in the Pro Tools mixer. For more information, see “Delay Compensation” on page 428.

There are three settings in the Playback Engine dialog for dedicating DSP resources for Delay Compensation:

**None** Allocates no DSP resources for automatic delay compensation.

**Short** Allocates minimal DSP resources for delay compensation for each channel. This is the most efficient setting for Pro Tools|HD Accel systems.

**Long** Allocates maximum DSP resources for delay compensation for each mixer channel. Long delay compensation uses the same DSP resources used by high DSP overhead plug-ins.

### To configure the Delay Compensation Engine:

- 1 Choose Setups > Playback Engine.
- 2 From the Delay Compensation Engine pop-up menu, select a Delay compensation setting.
- 3 Click OK.

The delay compensation setting is saved as a session and system preference.

## DAE Playback Buffer Size

The DAE Playback Buffer Size determines the amount of memory DAE uses to manage disk buffers, which affects system performance.

◆ Lower DAE Playback Buffer Size settings can improve playback and recording initiation speed. However, a lower setting can make it difficult for slower hard drives to play or record tracks reliably.

◆ Higher DAE Playback Buffer Size settings can allow for a higher density of edits in a session. However, a higher setting can cause a time lag to occur before playback or recording begins. It can also cause a time lag to occur when you are editing during playback.

### To change the DAE Playback Buffer Size:

- 1 Choose Setups > Playback Engine.

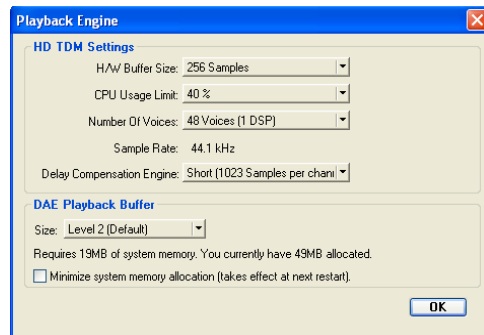

### Playback Engine dialog (Pro Tools 6.x)

2 From the DAE Playback Buffer pop-up menu, select a buffer size. Memory requirements for each setting are shown at the bottom of the Playback Engine dialog.

- 3 Click OK.

4 If Pro Tools needs more system memory for the DAE Playback Buffer, it will prompt you to restart your computer.



## System Memory Allocation

(Pro Tools 6.x for TDM Systems Only)

When you start your computer, Pro Tools automatically reserves a portion of system memory for the DAE Playback Buffer. This reserved memory is unavailable to other applications, even if Pro Tools is not running.

You can set Pro Tools to reserve only the minimum amount of required memory, so that system memory is available to other applications.

**To minimize system memory allocation:**

- 1 Choose Setups > Playback Engine.
- 2 Select the “Minimize System Memory Allocation” option.
- 3 Click OK.
- 4 On Windows systems, restart your computer.  
– or –

On Mac OS X systems, enter your password when prompted, then restart your computer.

---

## Configuring Pro Tools Hardware Settings

Pro Tools allows you to configure the signal routing, digital I/O format, default sample rate, clock source, and other hardware-based settings depending on your system configuration.

The following section outlines the configuration of a Pro Tools|HD system with one or more HD interfaces (with one or more MIX-series interfaces attached).

 *To configure a Pro Tools MIX-series, Pro Tools|24, or Pro Tools LE system, refer to the Getting Started Guide that came with that system.*

## Configuring Pro Tools|HD Hardware

On TDM systems, you configure Hardware settings for each audio interface connected to your system. For example, Pro Tools|HD-series systems can have 192 I/O, 192 Digital I/O, 96 I/O, or 96i I/O audio interfaces connected to HD Core and HD Accel or HD Process cards in the system. The 192 I/O, 192 Digital I/O, and 96 I/O can have additional interfaces attached (including older Digidesign audio interfaces, or *Legacy I/Os*, such as the 888|24 I/O, 882|20 I/O or 1622 I/O). For more information, see Chapter 2, “Pro Tools System Configurations.”

### Configuring Hardware Setup

The Main page of the Hardware Setup dialog is where you define which physical inputs and outputs on your audio interface are routed to available inputs and outputs in Pro Tools.

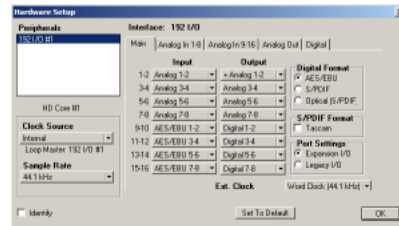

*Hardware Setup dialog for 192 I/O (Main page)*

Additional pages are available to configure other controls for each audio interface (such as setting operating levels). For details, refer to the *Getting Started Guide* for your system, or to the guide for your audio interface.

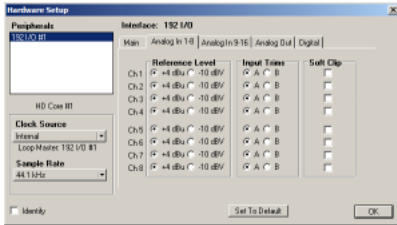

Hardware Setup dialog for 192 I/O (Analog In page)

 You can identify audio interface connections at any time by selecting the interface name in the Peripherals list, then clicking Identify. All the LEDs on the interface front panel will illuminate.

### To configure audio interfaces on a Pro Tools|HD system:

- 1 Choose Setups > Hardware Setup.
- 2 From the Peripherals list, select the Digidesign audio interface connected to the first card in your system. This will be the interface at the top of the list.
- 3 Click the Main tab.
- 4 From the Clock Source pop-up menu, select the appropriate clock source for the system. In most cases, you will use Internal. The other choices are for resolving Pro Tools to external clock sources. Depending on your audio interface, Clock Source options can include: AES/EBU [Encl], S/PDIF, Optical [Encl], AES/EBU 1–8, TDIIF, ADAT, and Word Clock (optional Word Clock rates are available when operating at higher sample rates).

5 From the Ext. Clock Output pop-up menu, select the appropriate clock output to send to devices attached to your audio interface.

6 Select which digital I/O port on your audio interface enclosure is active under Digital Format. Choices include: AES/EBU, S/PDIF, and Optical (S/PDIF). Selecting Optical (S/PDIF) resets the Optical I/O port (which is, by default, eight channels of ADAT I/O) to two channels of S/PDIF Optical I/O.

7 For S/PDIF compatibility with Tascam DA-30 DAT recorders select the Tascam option under S/PDIF Format.

8 For the 96 I/O, click the Meters pop-up menu and select whether to meter the input or output signal.

9 From the Input and Output pop-up menus, select the physical ports (such as Analog 1–2 or Optical 1–2), that will be routed to the corresponding Pro Tools input and output channels (such as Ch 1–2 or Ch 3–4), listed on the left side of the Main page.

Inputs and outputs of similar format are differentiated in the input and output channel pop-up menus. For example, the AES/EBU inputs and outputs in the 192 I/O enclosure are listed as AES/EBU [Encl], while the AES/EBU inputs and outputs on the factory-installed Digital I/O card are listed (in pairs) as AES/EBU 1–2, AES/EBU 3–4, AES/EBU 5–6, and AES/EBU 7–8. For 192 I/Os equipped with the optional Digital I/O Card, the additional AES/EBU I/O ports on the optional card are listed as AES/EBU 9–10, AES/EBU 11–12, AES/EBU 13–14, and AES/EBU 15–16.

10 Click other tabs (such as Analog In and Analog Out) for additional configuration options specific to the audio interface. These include:

- On the 96 I/O, configuring the operating levels of analog inputs and outputs (+4 dBu or –10 dBV).
- On the 96i I/O, configuring the operating levels of analog inputs and outputs (+4 dBu or –10 dBV).
- On the 192 I/O analog input, setting the input connector and Soft Limit
- On the 192 I/O, configuring the two sets of trims for analog inputs and outputs.
- On the 192 I/O and 192 Digital I/O, configuring real-time Sample Rate Conversion for digital inputs.
- On the 192 I/O and 192 I/O Digital, configuring inputs and outputs on any optional A/D card, D/A card, or Digital I/O cards installed in the unit.

 *For more information on Hardware Setup controls for each HD audio interface, refer to the Getting Started with HD Guide or the guide for that audio interface.*

**11** Repeat the above steps for each additional HD-series audio interface.

 *Use the Up and Down Arrow keys to scroll through peripherals in the Peripherals list.*

**12** Repeat the above steps for any Legacy I/Os connected to the HD-series audio interfaces in your system. Before you can configure a Legacy I/O, it must first be initialized in Hardware Setup (See “Initializing MIX-Series Peripherals (on a Pro Tools|HD System)” on page 43.)

**13** Click OK.

## Initializing MIX-Series Peripherals (on a Pro Tools|HD System)

Before you can configure a Legacy I/O, it must first be initialized in Hardware Setup.

### To initialize a Legacy I/O on a Pro Tools|HD system:

**1** Start up your Pro Tools system. See “Starting Up or Shutting Down Your System” on page 37.

**2** Make sure to lower the volume of your output devices. Very loud digital noise may be emitted before the Legacy I/O is initialized.

**3** Turn on your Legacy I/O.

**4** From the Peripherals list, choose the primary audio interface (the interface to which your Legacy I/O is connected).

**5** In the Main page of the Hardware Setup dialog, select the Legacy I/O option under Port Settings.

**6** In the Peripherals list, “No Interface” is listed twice, directly below the primary audio interface. Click the first “No Interface.” An Interface pop-up menu appears in the Hardware Setup dialog, listing supported I/O choices.

**7** From the Interface pop-up menu, select the type of Legacy I/O you connected.

**8** Set the External Clock Output on the HD interface to 256x, which is the required clock speed for Legacy I/Os.

After you select an audio interface, the Main page updates with controls that can be configured. Refer to the guide for your audio interface for details on each control.

9 Repeat the above steps for each additional Legacy I/O.

 For more information on Hardware Setup controls for each Legacy audio interface, refer to the guide that came with the interface.

## Configuring I/O Setup

The I/O Setup dialog provides a graphical representation of the signal routing for each connected audio interface, with controls to route physical ports on the audio interface to Pro Tools inputs and outputs. These controls mirror the routing controls found in the Hardware Setup dialog—changes made to physical routing in one dialog are always reflected in the other. The I/O Setup dialog lets you label and map Pro Tools input, output, insert, and bus *signal paths*. For more information on paths, path labeling, and path mapping, see Chapter 7, “I/O Setup.”

The I/O Setup dialog also provides important audition, meter, and surround settings. For more information, see Chapter 7, “I/O Setup.”

## Routing a Pro Tools Output Pair to Multiple Destinations

Pro Tools channel pairs can be routed to multiple outputs on an audio interface through the Hardware Setup dialog. For example, if you assign both Analog 1–2 and Analog 3–4 interface outputs to Pro Tools Output pair 1–2, when you send a signal to Pro Tools Outputs 1–2, that signal will be routed simultaneously to both pairs of output ports on your audio interface.

This lets you send the same signal (such as a stereo pair, a stem mix, or a multichannel mix) to multiple destinations (such as multiple mastering devices).

## To select multiple output ports for a Pro Tools output channel pair:

- 1 Choose Setups > Hardware Setup.
- 2 From the Peripherals list, select an interface.
- 3 Click the Main tab.
- 4 Select an output port pair from an Output pop-up menu.
- 5 Start-click (Windows) or Control-click (Macintosh) the same pop-up menu a second time to choose an additional output port pair.

The output name updates with a plus sign (“+”) before it to indicate that multiple output ports are selected. In the pop-up menu, each physical port pair assigned to that Pro Tools output pair is indicated by a check mark.

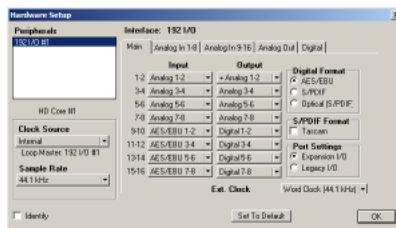

Hardware Setup dialog for 192 I/O (Main page)

- 6 Repeat the above steps to select additional output destinations. The only limit to output choices is the number of outputs available in your system.

Pro Tools output pairs can also be routed to multiple audio interface outputs in the I/O Setup dialog. For more information, see “Routing Hardware I/O to Pro Tools I/O” on page 71.

## Creating a New Session

The first step in beginning a Pro Tools project is creating a new session. When you do this, Pro Tools automatically creates a new folder named for your session. Within this folder is the session file and two subfolders (an Audio Files folder, and a Fade Files folder).

The Audio Files folder contains all audio recorded or converted during the session. The Fade Files folder contains any crossfaded audio data generated by the session.

When you record a new audio track, the track is saved as a new audio file to the Audio Files folder. You can also import other audio files into the session, and work with them as well.

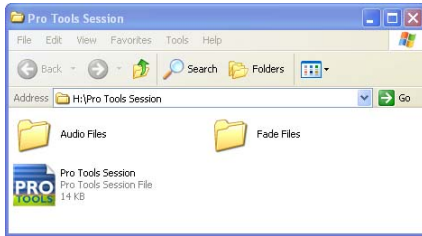

**Typical session folder**

For details on allocating audio tracks to different hard drive locations, including shared media volumes, see “Disk Allocation” on page 145.

### To create a new session:

- 1 Choose File > New Session.

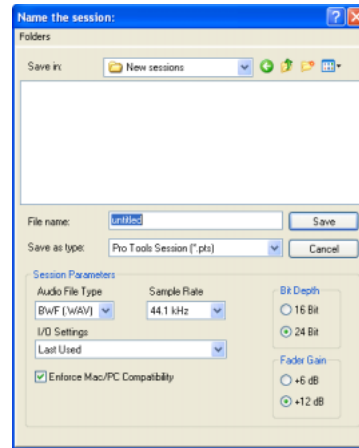

**New Session dialog**

- 2 Choose the drive where you want to save the session. The session should be saved on a dedicated audio drive.

- 3 Select “Enforce Mac/PC Compatibility” if you want to create session and audio files that can be used in either Windows or Macintosh versions of Pro Tools. See “Creating Macintosh and PC Compatible Sessions” on page 131 for more information.



*To use Japanese or non-ASCII characters in track and region names, or track comments, deselect the option for “Enforce Mac/PC Compatibility” when creating a new session.*

*If you save a session copy with the “Enforce Mac/PC Compatibility” option selected, all Japanese and non-ASCII characters will be lost.*

4 Select the audio file format for the session.

For optimum compatibility between Windows and Macintosh sessions, set the file type to BWF (.WAV).

Sound Designer II (SD II) files are not supported on Windows systems (or at sample rates above 48 kHz), and Pro Tools prevents you from choosing SD II as the file type if Enforce Mac/PC Compatibility is selected (or the session is on a PC).

5 Select the bit depth (16 bit or 24 bit) and the sample rate.

6 Select the Fader Gain (+12 dB or +6 dB).

7 Select the I/O Settings to use for the session. Several pre-configured I/O Settings are included with your system, or you can select a custom I/O Setting that you have created. See Chapter 7, “I/O Setup” for more information.

8 Name the Session.

9 Click Save.

## Selecting Bit Depth and Sample Rate

When selecting a bit depth or sample rate for your session, consider the disk space your selection will require. 24-bit audio files occupy about 50 percent more disk space than 16-bit audio files. 192 kHz audio files occupy about four times the space as 44.1 kHz audio files.

Bit depth and sample rate also have an effect on the amount of mixing power available in a session. Fewer mixer channels are available with 24-bit sessions and with sessions at higher sample rates. (For more information with TDM systems, see Appendix B, “TDM Mixing and DSP Usage.”)

It is not possible to combine different bit depths within a single Pro Tools session; files of different bit depths must be converted and imported into the session.

## Selecting a Fader Gain

### (Pro Tools 6.4)

Sessions in Pro Tools 6.4 can be created with a maximum fader gain of either +6 dB or +12 dB. The fader gain setting is saved with the session, and is set as the default.

Sessions created and saved with a +12 dB fader gain level can be opened in previous versions of Pro Tools, but breakpoints for volume automation above +6 dB will be lowered to +6 dB.



*The +12 dB Fader Gain setting only affects the position of the fader (both in Pro Tools and on control surfaces) above the 0 dB mark. Fader positions below 0 dB are unaffected.*

---

## Opening a Session

When you open a session, Pro Tools looks in the session folder for audio and fade files linked to the session.

### To open an existing session:

- 1 Choose File > Open Session.
- 2 Locate the session you want to open and click Open.

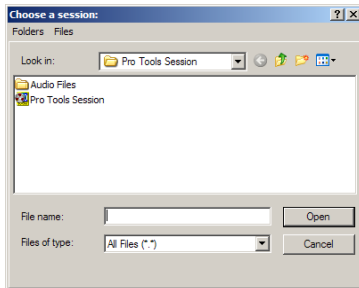

*Open Session dialog*

## Opening a Session that Contains Unavailable Files

### (Pro Tools 6.x Only)

With Pro Tools 6.x, the DigiBase feature will prompt you if files are located but reside on Transfer volumes (such as CD-ROMs), or if any required files cannot be found. See “Locating Audio Files” on page 129 for more details.

## Opening a Session that Contains Unavailable Resources

Pro Tools prompts you when opening a session that contains unavailable voices, I/O paths, DSP resources, or plug-ins. This is common when transferring sessions to systems with different Digidesign hardware.

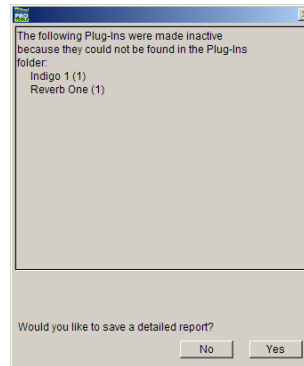

### Opening a session with unavailable resources

The dialog contains a summary of the missing session components. To save a text file containing a more detailed report, along with the resulting action, click Yes.

The following will occur when opening a session with unavailable items:

### With all Pro Tools Systems:

- ◆ Inserts assigned to unavailable plug-ins are made inactive.
- ◆ Inputs, outputs, and sends that are assigned to unavailable paths are made inactive.

### With Pro Tools TDM systems only:

- ◆ Any tracks beyond the maximum number of available voices on the current system are made inactive.

### With Pro Tools LE 6.x only:

◆ Any tracks beyond the maximum number of available voices on the current system are set to *voice off*.

## Selecting Fader Gain when Opening a Previously Recorded Session

When opening a session created in a previous version of Pro Tools, you are given the choice of staying at +6 dB or updating to +12 dB.

When opening a session created in the current version of Pro Tools, the session is opened with your previously saved fader gain settings.

**Opening a +12 dB session in a previous version of Pro Tools** Sessions created and saved with a +12 dB fader gain level can be opened in previous versions of Pro Tools. Breakpoints for volume automation above +6 dB will be lowered to +6 dB.

---

## Saving a Session

You should save regularly while working on your session to ensure that your work is preserved on your hard drive.

## Saving the Session File

The Save Session command saves the changes you have made to your session and writes them over the previously saved version of the session file. The Save Session command cannot be undone.

### To save a session:

- Choose File > Save Session.

## Revert to Saved Command

If you have made changes to a session since you last saved it, you can discard the changes and revert to its previously saved state.

### To revert to the last saved version of a session:

- Choose File > Revert to Saved.

## Saving the Session File with a New Name

To save a copy of the current session with a new name or to a different hard drive location, you can use the Save Session As command. Because the Save Session As command closes the current session and lets you keep working on the renamed copy, it is useful if you are experimenting and want to save successive versions of the session.

By working this way, you can quickly retrace your steps if you want to go back to an earlier version of your session. The Save Session As command saves a new version of the *session file* only—not duplicate versions of the audio or fade files.

### To save a session with a new name:

- 1 Choose File > Save Session As.
- 2 Enter a new name for your session.
- 3 Click Save.

The renamed session file is saved in the session folder along with the original session. Any new audio files that you record in your renamed session will be placed into the same Audio Files folder that was created for your original session.



## Saving a Copy of the Session

To save a copy of the current session along with its audio files and fade files, you can use the Save Session Copy In command. In addition, you can specify a session file format, audio file format, bit depth, and sample rate for the session copy.

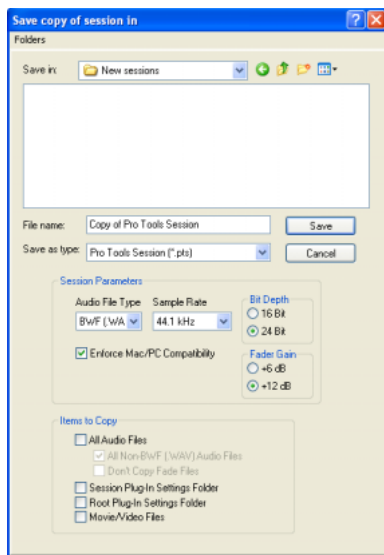

Save Session Copy In dialog

Unlike the Save Session As command, Save Session Copy In does not close the original session, so subsequent edits are made to the original session. Session copies can be used to archive important sessions, or as a means to prepare sessions for transfer to another Pro Tools system.

Save Session Copy In saves only the audio being used in the session. Any audio that was recorded or imported and then later removed from the session will not be included in the new session copy.

Using the Save Session Copy In command is the only way to change the sample rate of a session.

💡 When you Save Session Copy In with a lower bit rate, Dither (and Noise Shaping) may be applied. See the following table:

Dither and Noise Shaping with Save Session Copy In

Bit Rate	Dither	Noise Shaping
24-bit to 24-bit	No	No
16-bit to 24-bit	No	No
24-bit to 16-bit	Yes	Yes
16-bit to 16-bit	No	No

## Session Format

You can save the session copy in the following formats, depending on your platform:

Windows:

- Pro Tools Session (\*.pts); supports Pro Tools 5.1 and higher
- Pro Tools 5.0 Session (\*.pt5)
- Pro Tools 4 24-Bit Session (\*.p24)
- Pro Tools 4 16-Bit Session (\*.pt4)

Macintosh:

- Latest; supports Pro Tools 5.1 and higher
- Pro Tools 5.0 Session
- Pro Tools 4 24-Bit Session
- Pro Tools 4 16-Bit Session
- Pro Tools 3.2 Session

When saving sessions to versions lower than 5.1, multichannel tracks (including stereo) and multi-mono plug-ins are lost. In this case, make sure to first separate the tracks and plug-ins to individual mono tracks.

## Session Parameters

### Audio File Type

You can save the session to reference BWF (.WAV) or AIFF audio files. On the Macintosh, you can also save the session to reference SD II audio files (at sample rates up to 48 kHz).

**⚠** *SD II sessions are not supported with Pro Tools for Windows, or with sample rates higher than 48 kHz. You cannot set the session audio file type to SD II on the Macintosh if Enforce Mac/PC Compatibility is selected, or if the sample rate of the destination session is greater than 48 kHz.*

### Using Mixed File Types

A session can use mixed audio file types. If your original session has mixed file types, they are not converted to a different file type unless you specify that they be converted. However, when using mixed file types, audio performance will be reduced (due to additional file handling required for some file formats).

### Bit Depth

You can save the new session at 16-bit or 24-bit depth. If your session is in a different bit depth, audio files are converted to the new session bit depth, and copied to the location you specify.

### Sample Rate

You can save the new session at sample rates of 44.1 kHz or 48 kHz (on Mbox, Digi 001 and MIX-series systems) and at sample rates up to 96 kHz (on Digi 002, Digi 002 Rack and HD-series systems with a 96 I/O or 96i I/O) or up to 192 kHz (on HD-series systems with a 192 I/O or 192 Digital I/O). If your session is at a different sample rate, audio files are converted to the new session sample rate, and copied to the location you specify.

The higher the quality of sample rate conversion you choose, the longer Pro Tools will take to process the audio file.

### Fader Gain

You can save the new session with a +6 dB or a +12 dB maximum fader gain. When saving a +12 dB session as a +6 dB session, Pro Tools alerts you that any automation breakpoints over +6 dB will be lowered to +6 dB.

### Enforce Mac/PC Compatibility

This setting forces Windows or Macintosh versions of Pro Tools to create sessions and audio files that are usable on both platforms. For more information, see “Creating Macintosh and PC Compatible Sessions” on page 131.

## Items to Copy

### All Audio Files

When this option is selected, all audio files are copied to the new location.

This setting is automatically selected if you are changing the bit depth or sample rate of the session.

### All (Non-Native) Audio Files

The name of this option varies depending on the audio file type you select. If you are changing the audio file type of the session, this option ensures that all files in the copied session are converted to the selected file type. Use this option to avoid the reduced performance of a session with mixed file types.

This option is automatically selected if you are changing bit depth or sample rate, or copying a session on the Macintosh from SD II format to AIFF or BWF (.WAV) format with Enforce Mac/PC Compatibility selected.

### Don't Copy Fade Files

When this option is selected, Fade Files are not copied to the new session Fade Files folder. When the session is launched, the Find Files dialog will prompt you to locate Fade Files. You can either locate the existing fades using the find file dialog, or Skip All to let Pro Tools recreate the fades from the session document.

### Session Plug-In Settings Folder

When this option is selected, the session's Plug-In Settings folder is copied to the new location. The references to these plug-in settings in the session are redirected to point to the copied settings files.

### Root Plug-In Settings Folder

When this option is selected, the contents of the root-level Plug-In Settings Folder are copied into a folder named *Place in Root Settings Folder*, indicating that these files will need to be moved to the root level plug-in settings folder on the destination system before you can use them. The references to these settings files in the session are *not* redirected to point to the copied files.

### Movie/Video Files

When this option is selected, session movie files (such as Avid or QuickTime video files) are copied to the new location, and session references are updated to point to the copied movie files.

#### To save a session copy in a new location:

- 1 Choose File > Save Session Copy In.
- 2 In the Save Session Copy dialog, choose a destination and enter a name for the new session file.

- 3 Set the Audio File Type to BWF (.WAV) or AIFF, or SD II. If the audio files need to be compatible with either Windows or Macintosh, select or BWF (.WAV) or AIFF.

- 4 Set the Sample Rate and Bit Depth for the session.

- 5 Select "Enforce Mac/PC Compatibility" if you want to create session and audio files that can be used in either Windows or Macintosh versions of Pro Tools. See "Creating Macintosh and PC Compatible Sessions" on page 131 for more information.

- 6 Select the Items to Copy to the new session.

- 7 Click Save.

---

## Creating Custom Session Templates

You can create custom session documents that are pre-configured to the track setups, mixer setups, window arrangements, and zoom level memory locations that you use most frequently. Doing this will save you the trouble of having to create your studio setup from scratch every time you start a new session.

### Creating Windows Templates

In Windows, you can create a session template by making a session file a Read Only document.

#### To create a custom session template in Windows:

- 1 Create a session and arrange its elements as you want them to appear in the template. You can also define elements such as signal routings, insert and send configurations, track views, Ruler settings, and Preference settings.
- 2 Choose File > Save Session As.
- 3 Name the session and click Save.

- 4 Close the session.
- 5 Locate the session file that you just saved.
- 6 Right-click the file and choose Properties.
- 7 Under Attributes, deselect Archive and select Read Only.

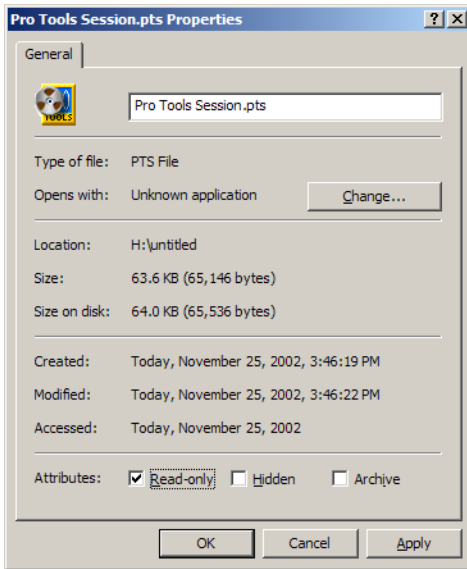

#### Making a session a Read Only file (Windows)

- 8 Click OK.

To use this template, double-click it or open it with the Open Session command. When you first save the session, Pro Tools will ask you to give the session a new name. Your original session template will remain unchanged.

To modify the session template, you will need to reopen its Properties, deselect the Read Only option and select the Archive option, make your modifications, then change it back to a Read Only file.

## Creating Macintosh Templates

On the Macintosh, you can create a session template by saving a session file as a *Stationery Pad* document. Once a session is saved as a Stationery Pad, it acts as a template that you can open and then resave as a normal session.

#### To create a custom session template on the Macintosh:

- 1 Create a session and arrange its elements as you want them to appear in the template. In addition to track setup, you can also define elements such as signal routings, insert and send configurations, Mix and Edit window views, Ruler settings, and Preference settings.
- 2 Choose File > Save Session As.
- 3 Name the session and click Save.
- 4 Close the session.
- 5 Locate the session file that you just saved.
- 6 Click once on the file to select it.
- 7 Choose File > Get Info > General Information.



#### Saving a session as a Stationery Pad (Macintosh)

- 8 Select the Stationery Pad option to save the file as a template, then close the information window.

To use this template, double-click it or open it with the Open Session command if you are already running Pro Tools. You can create several custom templates for studio setups that you frequently use.

When you open a session saved as a Stationery Pad, Pro Tools gives you the option of editing the template or starting a new session using the template settings. If you choose New Session, Pro Tools will create a new folder containing a copy of your session template and Audio and Fades folders.

---

## Closing a Session

Because Pro Tools allows you to work on just one session at a time, you must close the current session if you want to work on another. The Close Session command closes your current Pro Tools session but leaves the Pro Tools application open. You can save your work using the Save Session or Save Session As command before closing the current session.

### To close a session:

- Choose File > Close Session.

---

## Quitting Pro Tools

Although Pro Tools will warn you before allowing you to quit without saving changes, you should generally save your work before quitting.

### To exit Pro Tools in Windows:

- Choose File > Exit.

### To quit Pro Tools on the Macintosh:

- Choose Pro Tools > Quit Pro Tools (Pro Tools 6.x) or File > Quit (Pro Tools 5.3.x and lower).

---

## Sharing Sessions Between Pro Tools TDM Systems and Pro Tools LE Systems

Pro Tools makes it easy to share sessions between Pro Tools LE and TDM-equipped systems. There are some important differences between the two types of systems that can affect how session material is transferred.

### Differences between TDM and LE systems

Feature	TDM Systems	LE Systems
Number of Audio Tracks	up to 256 (HD-series)  up to 128 (MIX-series)	up to 32 (Pro Tools 6.x on all systems)
Number of Mix Busses	64 busses	16 busses
Inserts per Track	up to 5 inserts	up to 5 inserts
Sends per Track	up to 5 sends	up to 5 sends

 For details on transferring sessions between Windows and Macintosh systems, see “Moving Sessions Between Platforms with MacOpener (Using HFS/HFS+ Drives)” on page 133.

## Opening a TDM Session in Pro Tools LE

When opening a TDM session in Pro Tools LE, the following rules apply:

- With Pro Tools LE 6.x (all systems) or Pro Tools 5.3.1 and higher (Windows):
  - Any tracks beyond the first 32, as well any inactive tracks, are set to *voice off*.
  - Multichannel surround tracks are removed from the session.
  - Any assignments to busses beyond 16 are made inactive.
  - Unavailable input and output paths are made inactive.
  - TDM plug-ins with RTAS equivalents are retained; those without equivalents are made inactive.
- With Pro Tools LE 5.3.x and lower (Macintosh) or Pro Tools LE 5.1.x and lower (Windows):
  - Any tracks beyond the first 24, as well any inactive tracks, are removed from the session.
  - Multichannel surround tracks are removed from the session.
  - Any assignments to busses beyond 16 are made inactive.
  - Unavailable input and output paths are made inactive.
  - TDM plug-ins with RTAS equivalents are retained; those without equivalents are made inactive.

## Preferences

The Preferences dialog has several tabbed pages in which you can specify your preferred settings for various session parameters. Each new session will use these preferences.

### Display Preferences

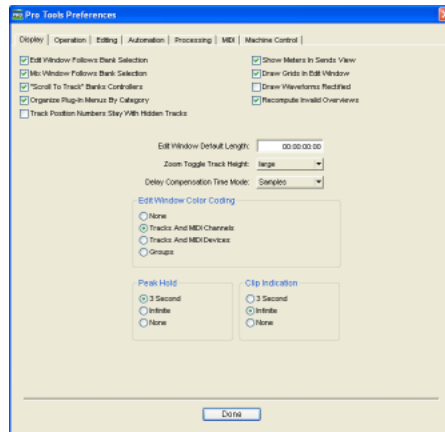

**Edit Window Follows Bank Selection** If you are using a supported control surface with Pro Tools, this option scrolls the Edit window to display the selected bank of tracks when you switch banks on the control surface, ensuring that the current bank is viewable on-screen.

**Mix Window Follows Bank Selection** If you are using a supported control surface with Pro Tools, this option scrolls the Mix window to display the selected bank of tracks when you switch banks on the control surface, ensuring that the current bank is viewable on-screen.

**“Scroll to Tracks” Banks Controllers (Pro Tools 6.4)** When using a control surface (such as D-Control or Pro Control) you can select this option to bank control surface faders to a numbered track when invoking the “Scroll to Track Number” command.

**Organize Plug-Ins Menus by Category (Pro Tools 6.4)** When enabled, plug-ins are automatically organized by category (effect type). Plug-ins that do not fit into a standard category (such as the DigiRack Signal Generator), or third-party plug-ins that have not been defined by their developers, appear in the Other category. Plug-ins can appear in more than one category.

**Track Numbers Stay With Hidden Tracks (Pro Tools 6.4)** When enabled, tracks keep their track numbers even when hidden. By default, numbers are only assigned to tracks that are shown. Active tracks are then numbered sequentially, and hidden tracks are un-numbered.

**Show Meters in Sends View** When the Sends View is displaying individual send controls, you can select this option to show send level meters. Deselecting this option can help speed up screen redraws and processing.

**Draw Grids in Edit Window** Adds grid lines to the Edit window. Grid line resolution is based on the zoom level of the Edit window.

**Draw Waveforms Rectified** Displays audio waveform data in rectified view. In this view, audio waveforms are displayed so that their positive and negative waveform excursions (the portions that fall above and below the center line) are summed together and viewed as a single positive-value signal. This view allows more waveform detail to be seen in either normal or reduced track height views. It can be particularly useful when editing volume automation data, since it depicts waveform levels as starting at the bottom of the track.

**Recompute Invalid Overviews** Prompts Pro Tools to look for missing or corrupted overview data (the data used to create waveform displays) when it opens sessions. If Pro Tools finds that overview data is missing or corrupted, it will recreate one or more overviews for the session. This may take some time if there are many tracks in the session. If you suspect that overview data for a session has become corrupted, or if you import audio files which have no overview data into a session, make sure this preference is enabled for the session, save and close the session, then reopen it. Pro Tools will recreate any overviews for the session when it opens.

**Edit Window Default Length** This option allows you to set a default length for the Edit window in hours, minutes, seconds, and frames. This is useful if you want to assemble a session of a particular length or leave extra room to expand the Edit window's work area in your session. There is a 13 hour maximum limit for the length of a Pro Tools session.

**Zoom Toggle Track Height** Sets the default track height when the Zoom Toggle function is used to zoom in on a selection.

**Delay Compensation Mode (Pro Tools 6.4)** This option lets you choose whether information in the Delay Manager is displayed in milliseconds or samples.

## Edit Window Color Coding

Edit Window Color Coding determines how colors are assigned to the waveform display in the Edit window.

**None** Turns off color assignment to the waveform display of tracks in the Edit window.

**Tracks and MIDI Channels** Assigns a color to the waveform display of each track in the Edit window according to its voice number and MIDI channel assignment.

**Tracks and MIDI Devices** Assigns a color to the waveform display of each track in the Edit window according to its voice number and MIDI device type.

**Groups** Assigns a color to the waveform display of each track in the Edit window according to its group ID. If groups are suspended using the Suspend Groups command, all waveforms will be displayed in black.

## Peak Hold Options

These options determine how long the peak indicators on track meters stay lit after a peak is detected.

**3 Second Peak Hold** When this option is selected, track meters display the last peak level for three seconds.

**Infinite Peak Hold** When this option is selected, track meters display the last peak level until you click them to clear them.

**No Peak Hold** When this option is selected, track meters do not hold the peak level.

## Clip Indication Options (Pro Tools 6.4)

These options determine how long the clip indicators on plug-in, send, and track meters stay lit after a clip is detected.

**3 Second Peak Hold** When this option is selected, meters display the last clip indication for three seconds.

**Infinite Peak Hold** When this option is selected, meters display the last clip indications until you click them to clear them.

**No Peak Hold** When this option is selected, meters do not hold the clip indication.

## Operation Preferences

In Pro Tools 6.3 and lower, the Operation Preferences page included Machine Control and Remote Control options. With Pro Tools 6.4, these are located in the Machine Control Preferences page. For information on these controls, see “Machine Control Preferences” on page 65.

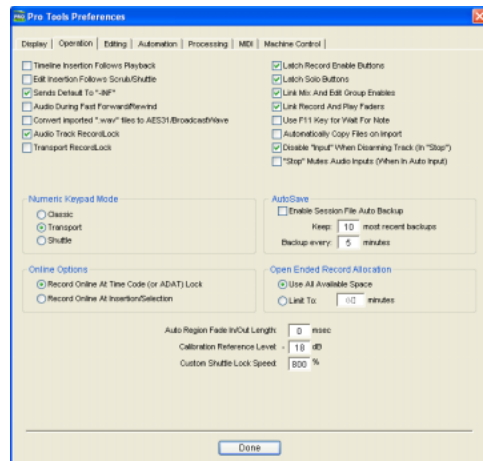

**Timeline Insertion Follows Playback** This option causes the screen's play cursor to update its location to the point where playback stops.

**Edit Insertion Follows Scrub/Shuttle** When selected, the edit cursor automatically locates to the point where scrubbing stops.



### **Support Background Record Applications**

**(Pro Tools 6.0.x and Lower Only)** Allows other audio recording applications to run in the background concurrently with Pro Tools. Files recorded in the background can be imported into Pro Tools, and then trimmed and viewed while recording continues. (In Pro Tools 6.1, audio recording in the background is always supported.)

**Sends Default to -INF** When selected, the initial fader level of newly-created sends is set to  $-\infty$  (no audible signal level). When not selected, the initial fader level of newly-created sends is set to 0 dB.

**Audio During Fast Forward/Rewind** When selected, audio is audible during fast-forward or rewind.

**Convert Imported “WAV” Files To AES31/BroadcastWave** When selected, this option applies to all newly imported WAV files, making them compliant with the AES31/EBU Broadcast standard. In Pro Tools 6.0 and lower, this option was located in the Compatibility page (see “Compatibility Preferences” on page 64).

**Audio Track RecordLock (Pro Tools 6.4)** This setting lets Pro Tools tracks be configured to either emulate a digital dubber, or to maintain legacy behavior for track record status.

- When the Audio RecordLock preference is enabled, the record-enabled audio tracks remain armed when playback or recording stops.
- When the Audio RecordLock preference is not enabled, record-enabled audio tracks are taken out of record enable when Pro Tools is stopped. This prevents tracks from remaining armed from pass to pass, emulating track record behavior of a digital dubber.

**Transport RecordLock (Pro Tools 6.4)** This setting lets the Transport Record be configured to either emulate a digital dubber, or to maintain legacy behavior for the Transport master Record.

- When not enabled, the Transport Record disarms when Pro Tools is manually stopped or stops due to a loss of time code. This replicates legacy Pro Tools recording behavior.
- When enabled, the Transport Record remains armed when playback or recording stops. This saves having to re-arm the Transport between takes, emulating digital dubber behavior.

 *The Transport RecordLock preference is automatically disabled and greyed out when Destructive record mode is enabled.*

### **Limit Pull Ups to NTSC/PAL Film Standards**

**(Pro Tools 6.3 and below)** This option, which is selected by default, filters the list of available Pull Up rates that appears in the Session Setup window.

**Latch Record Enable Buttons** When this option is deselected, it prevents multiple audio tracks from being record-enabled. Record-enabling an audio track takes any other audio track out of record-enabled mode.

**Latch Solo Buttons** When this option is deselected, it prevents multiple tracks from being soloed. Soloing a track will un-solo any other track that is soloed.

**Link Mix and Edit Group Enables** When this option is selected, it links enabling and disabling of Mix and Edit groups. For example, enabling Group A in the Edit Window automatically enables Group A in the Mix window.

**Use F11 Key for Wait for Note** When this option is selected, pressing the F11 Function key puts MIDI recording in Wait for Note mode.

**Automatically Copy Files on Import** When this option is selected, Pro Tools copies all imported audio files to the current session's Audio Files folder, regardless of whether they need to be converted to the current session's file type, bit depth or sample rate.

**Disable “Input” When Disarming Track (In “Stop”) (Pro Tools 6.4)**

For flexibility, TrackInput can be customized to remain selected regardless of track record status, or to automatically switch to Auto Input monitoring after a recording pass. This lets you optimize monitoring for a typical dubbing workflow (in which you might want tracks to remain in Input Only mode until explicitly switched to Auto Input monitoring) or a typical music tracking workflow (in which leaving a track in Input Only monitoring mode after recording can result in accidental double-monitoring).

- When enabled, taking an audio track out of record enable (any mode) takes it out of Input Only mode, regardless of the global monitor mode, and switches it to monitor audio from disk only.
- When not enabled, audio tracks will remain in Input Only monitoring mode until explicitly switched to Auto Input monitoring.

**“Stop” Mutes Audio Inputs (When In Auto Input) (Pro Tools 6.4)**

- When enabled, Pro Tools mutes tracks that are record-enabled when the Transport is stopped. Input can still be monitored while stopped using the TrackInput button.
- When not enabled, Pro Tools monitors audio input on tracks that are record-enabled.

## Numeric Keypad Mode

Numeric Keypad Mode determines how the numeric keypad functions. You can always use the numeric keypad to select and enter values in the Event Edit Area, Location Indicators, and Transport fields.

**Classic** Shuttle Lock mode that emulates the way Pro Tools worked in versions lower than 5.0. With the Numeric Keypad Mode set to Classic, you can play up to two tracks of audio in Shuttle Lock mode. Press the Start key (Windows) or Control (Macintosh), followed by 0–9 for different play speeds. Press Plus (+) or Minus (–) to reverse direction. Recall Memory Locations by typing the Memory Location number, followed by period (.). To customize the highest fast-forward Shuttle Lock speed (Pro Tools 6.2 and higher on Pro Tools|HD systems only), see “Custom Shuttle Lock Speed” on page 244.

**Transport** Shuttle Lock mode that lets you set a number of record and play functions, and also operate the Transport from the numeric keypad. With the Numeric Keypad Mode set to Transport, you can play up to two tracks of audio in Shuttle Lock mode. Press the Start key (Windows) or Control (Macintosh), followed by 0–9 for different play speeds. Press Plus (+) or Minus (–) to reverse direction. Recall Memory Locations by typing period (.), the Memory Location number, and period (.) again. To customize the highest fast-forward Shuttle Lock speed (Pro Tools 6.2 and higher on Pro Tools|HD systems only), see “Custom Shuttle Lock Speed” on page 244.

**Shuttle (TDM Only)** Selects a type of shuttling different from that of Shuttle Lock mode. With the Numeric Keypad Mode set to Shuttle, playback is triggered by pressing and holding the keys on the numeric keypad—playback stops once the keys are released. Various playback

speeds are available in both forward and reverse. You can also recall Memory Locations by typing period (.), the Memory Location number, and period (.) again.

### **AutoSave**

This preference determines how the AutoSave feature functions.

**Enable Session File Auto Backup** When this option is selected, Pro Tools automatically saves backups of your Pro Tools session file while you work. Use the Keep and Backup Every fields to specify the total number of incremental backups that are kept and how often the session is saved.

### **Online Options**

#### **Record Online at Time Code (or ADAT)**

**Lock** When this option is selected, online recording begins as soon as Pro Tools receives and locks to time code or ADAT sync.

**Record Online at Insertion/Selection** When this option is selected, online recording begins at the Edit cursor location. Recording continues until Pro Tools stops receiving time code. If you make a selection, Pro Tools records online for the length of the selection.

#### **Open Ended Record Allocation**

This preference determines how much of your available hard drive space is allocated for recording.

**Use All Available Space** When selected, the drive's entire available space is allocated. This can sometimes slow down the recording process for hard drives that use certain file systems, including HFS+ and NTFS.

**Limit To** Sets the maximum allowable recording duration. This can help reduce the time it takes to begin recording by allocating only a portion of your hard drive. The number of minutes specified is allocated for each record-enabled track. You may want to experiment with this number to achieve the recording performance you want.

**Auto Regions Fade In/Out Length** Sets a default length for fade-ins and fade-outs automatically applied to region boundaries. Using automatic fade-ins and fade-outs saves you the trouble of editing to zero-crossings or creating numerous rendered fades in order to eliminate clicks or pops in playback. Autofades are not written to disk. Value range is from 0–10 ms for the Auto Region Fade In/Out Length. A value of zero (the default) means that no auto-fading will occur. The Auto Fade value is saved with the session, and is automatically applied to all free-standing region boundaries until you change it.

**Calibration Reference Level** Sets a default calibration reference level in dB when Pro Tools is in Calibration mode.

**Custom Shuttle Lock Speed (Pro Tools 6.2 and Higher on Pro Tools|HD Systems)** This option sets the highest fast-forward Shuttle Lock speed (key 9) for Shuttle Lock modes (Classic or Transport). The range for this setting is 50–800%. For more information, see “Custom Shuttle Lock Speed” on page 244.

## Editing Preferences

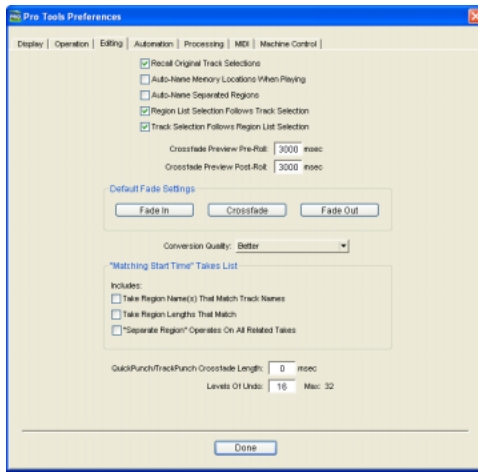

**Recall Original Track Selections** When this option is selected, Memory Locations that recall a selection also recall the track in which the selection was made.

**Auto-Name Memory Locations When Playing** When this option is selected, Pro Tools gives new memory locations default names based on their time location in the session. The time units currently chosen in the Display menu determine the units for the names.

**Auto-Name Separated Regions** When this option is selected, Pro Tools automatically names newly separated regions by appending a number to the region's name.

**Region List Selection Follows Track Selection** When this option is selected, selecting a region in a track also selects it in the Regions List.

**Track Selection Follows Regions List Selection** When this option is selected, selecting a region in the Regions List causes Pro Tools to highlight that region's occurrence in a track.

**Crossfade Preview Pre-Roll** This option specifies the amount of pre-roll to be added when you are auditioning crossfades in the Fades dialog.

**Crossfade Preview Post-Roll** This option specifies the amount of post-roll to be added when you are auditioning crossfades in the Fades dialog.

### Default Fade Settings

**Fade In** Selects the default envelope shape for fade-ins.

**Crossfade** Selects the default envelope shape for crossfades.

**Fade Out** Selects the default envelope shape for fade-outs.

**Conversion Quality** Selects the sample rate conversion quality. Sample rate conversion is used in a variety of Pro Tools processes including converting and importing audio files of different formats into a session, and bouncing and saving tracks to a different sample rate or bit depth. The higher the quality of sample rate conversion you choose, the longer Pro Tools will take to process the audio file.

### “Matching Start Time” Takes List

When you Control-click (Windows) or Command-click (Macintosh) a region in a track, Pro Tools displays a list of regions whose time stamp matches the current cursor location. The following preferences determine which regions, or *takes*, appear in this list:

**Take Region Names That Match Track Names** When this option is selected, only regions that share the same root name with the track and playlist appear in the Takes List pop-up menu.

**Take Region Lengths That Match** When this option is selected, only regions that match the length of the current selection appear in the Takes List pop-up menu.

**“Separate Region” Operates On All Related Takes** When this option is selected, editing a region with the Separate Region command also affects all other related takes (recording passes) with the same User Time Stamp. This option helps you compare different sections from a group of related takes.

**QuickPunch/TrackPunch Crossfade Length** Specifies a default length for crossfades created by QuickPunch or TrackPunch recordings. Crossfades occur before the punch in and after the punch out.

**Levels Of Undo** Sets the maximum number of actions that can be undone with the multiple undo feature. Setting this to a lower number can speed up the performance of slower computers. Pro Tools 6.1 supports up to 32 Levels of Undo. Pro Tools 6.0 and lower support up to 16 Levels of Undo.

## Automation Preferences

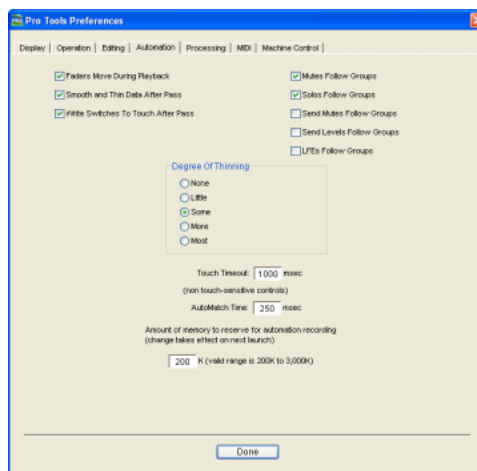

**Faders Move During Playback** When this option is selected, on-screen faders move if automation has been written for them. When this option is deselected, on-screen faders do not move, but automation still functions. Deselecting this option can help speed up screen redraws and processing.

**Smooth and Thin Data After Pass** When this option is selected, Pro Tools automatically smooths and then applies the specified amount of thinning to the automation data created in an automation pass. (See “Thinning Automation” on page 465.)

**Write Switches To Touch After Pass** (TDM Systems Only) When this option is selected, after an automation pass in Auto Write mode, Pro Tools automatically switches to Auto Touch mode. On TDM systems, you can choose to stay in Auto Write mode by deselecting this option.

**⚠** *Write Switches to Touch After Pass does not affect Trim mode. In Trim mode, tracks do not automatically change from Trim/Auto Write to Trim/Auto Touch after an automation pass.*

**Mutes Follow Groups** When this option is selected, muting a track that belongs to a Mix group mutes all members of the group. When this option is deselected, tracks are muted individually. You can also mute individual group members by Right-clicking (Windows) or Control-clicking (Macintosh) their Mute buttons.

**Solos Follow Groups** When this option is selected, soloing a track that belongs to a Mix group solos all members of the group. When this option is deselected, tracks are soloed individually. You can also solo individual group members by Right-clicking (Windows) or Control-clicking (Macintosh) their Solo buttons.

**Send Mutes Follow Groups** When this option is selected, muting a Send on a track that belongs to a Mix group mutes the corresponding Send (A–E) on all members of the group. When this option is deselected, Sends are muted individually. You can also mute individual group members by Right-clicking (Windows) or Control-clicking (Macintosh) their Solo buttons.

**Send Levels Follow Groups** When this option is selected, adjusting the level of a Send on a track that belongs to a Mix group adjusts the level of the corresponding Send (A–E) on all members of the group. When this option is deselected, Send levels are adjusted individually. You can also adjust individual group members by Start-dragging (Windows) or Control-dragging (Macintosh) their Send level faders.

**LFEs Follow Groups** When this option is selected, adjusting an LFE (Low Frequency Effects) control of a track or send that belongs to a Mix group adjusts the LFE controls of all members of the group. When this option is deselected, LFE controls are adjusted individually. You can also adjust individual group members by Start-dragging (Windows) or Control-dragging (Macintosh) their LFE controls. With send-based LFEs, grouping affects only that Send (A–E) on other tracks.

**Degree of Thinning** Specifies the amount of thinning performed on automation data when you use the Thin Automation command, or if you have selected the Smooth and Thin Data After Pass option. (See “Thinning” on page 456.)

**Touch Timeout** If you are writing automation in Auto Touch mode and you stop moving a non-touch sensitive control, Pro Tools continues to write automation for the Touch Timeout value.

After the Touch Timeout period, writing of automation stops and the automation data returns to its previous automation value at the rate specified in the *AutoMatch Time* setting.

**AutoMatch Time** If you are writing automation in Auto Touch mode, when you release a fader or control, writing of automation stops and the automation data returns to its previous automation value. The rate of return to the previous value is the AutoMatch Time. See “AutoMatch” on page 456.

**Amount of memory to reserve for automation recording** Allocates memory for automation. See “Setting the Automation Buffer Size” on page 457 for details.

## Processing Preferences

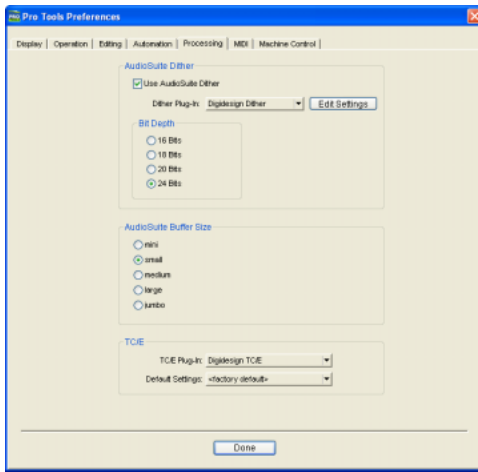

### AudioSuite Dither

**Use AudioSuite Dither** When selected, applies dither to specific AudioSuite processing tasks, such as Gain and Normalize.

**Dither Plug-In** Specifies the plug-in used for dither processing when the Use AudioSuite Dither option is selected.

**Edit Settings** When a Digidesign dither plug-in is used, lets you apply either normal or noise-shaping dither.

### Bit Depth

**16-, 18-, 20-, and 24-Bit** Lets you select a bit depth for the dithered audio.

### AudioSuite Buffer Size

Audio Suite Buffer Size sets the size of the memory buffer used for audio processing and previewing with AudioSuite plug-ins. If AudioSuite preview stutters, set the buffer to Mini or Small. Processing is generally faster when the buffer is set to Larger or Jumbo.

### TC/E

**TC/E Plug-In** Allows you to choose the plug-in used for Time Compression and Expansion when you edit audio with the Time Trimmer tool. The Time Trimmer works by using Time Compression/Expansion to match an audio region to the length of another region, a tempo grid, a video scene, or other reference point.

**Default Settings** Specifies the default settings used by the chosen Time Compression/Expansion plug-in.

## Compatibility Preferences (Pro Tools 6.0.x and Lower Only)

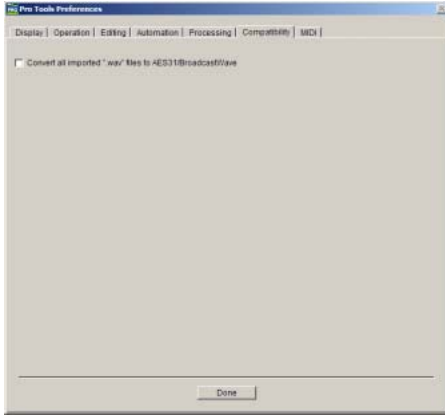

**Convert Imported “WAV” Files To AES31/BroadcastWave** When selected, this option applies to all newly imported WAV files, making them compliant with the AES31/EBU Broadcast standard.

## MIDI Preferences

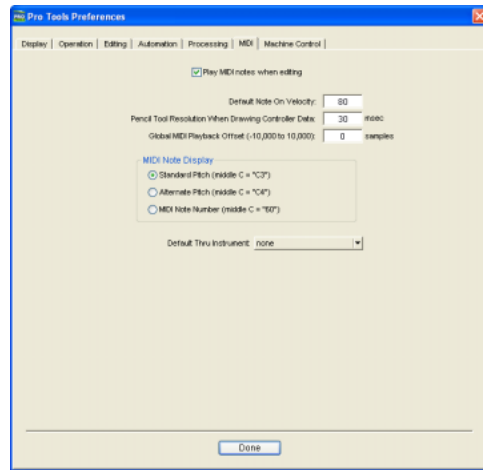

**Play MIDI Notes When Editing** When selected, causes MIDI notes to sound when you insert them with the Pencil or drag them with the Grabber.

**Default Note On Velocity** Sets the default Note On velocity for MIDI notes inserted in the Edit window and the MIDI Event List.

**Pencil Tool Resolution** Sets the default resolution for MIDI controller data created with the Pencil. Setting this to a lower resolution helps avoid creating controller data that is unnecessarily dense. The value range is from 1 to 100 milliseconds.

**Global MIDI Playback Offset** Sets an offset in samples to compensate for MIDI latency. Entering a value here has the same effect as setting an offset with the MIDI Track Offset command (Windows > MIDI Track Offset). Offset values can be positive (later) or negative (earlier).

**MIDI Note Display** Sets the reference for middle C as C3, C4, or MIDI note number 60.



**Default Thru Instrument** Sets the default MIDI Thru instrument from your available MIDI instruments.

## Machine Control Preferences

### (Pro Tools 6.4)

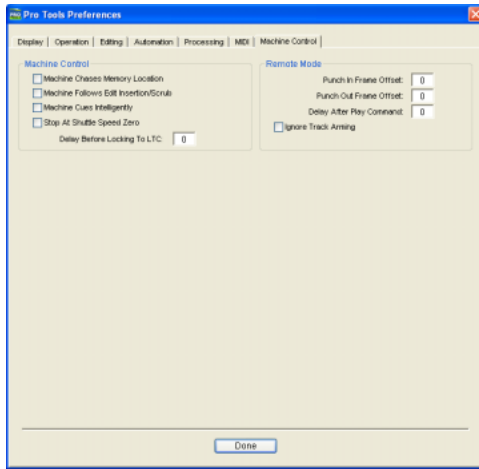

These preferences determine how a connected transport responds to Pro Tools.

With Pro Tools 6.4, Machine Control has its own tabbed page, and includes both Machine Control and Remote Control options. In Pro Tools 6.3 and lower, Machine Control and Remote Control options were on the Operations Preferences page.

### Machine Control

**Machine Chases Memory Location** When selected, navigating to a specific location in a session with a Memory Location causes a connected transport to chase to that location.

**Machine Follows Edit Insertion/Scrub** When selected, navigating to a specific location in a session by moving the selection point or by scrubbing a track will cause a connected transport to chase to that location.

**Machine Cues Intelligently** When selected, if you navigate to a cue point that is more than 10 seconds from the current location, Pro Tools will command a connected transport to fast wind to the new location at full speed to within 10 seconds of the cue point. Cueing will then slow to normal speed until the point is reached. This can significantly speed up tape cueing with certain video transports.

**Stop at Shuttle Speed Zero** Causes Pro Tools to send a Stop command whenever you stop shuttling. This is useful if you have a machine that requires an explicit stop command to park correctly.

### Remote Mode (9-pin Deck Emulation)

#### (TDM Systems Only)

**Punch In Frame Offset** Sets an offset (in frames) to compensate for punch in timing advances or delays.

**Punch Out Frame Offset** Sets an offset (in frames) to compensate for punch out timing advances or delays.

**Delay After Play Command** Sets an offset (in frames) to compensate for lockup time of external machines.

**Ignore Track Arming** Sets Pro Tools to ignore incoming track arming (record enable) commands. This is useful if you are using a master controller to arm tracks on other machines, but you don't want to arm tracks in Pro Tools.



# Chapter 7: I/O Setup

The I/O Setup dialog provides tools to label, format, and map Pro Tools input, output, insert, or bus *signal paths* for each session.

A signal path is a logical grouping of multiple inputs, outputs or busses that has a single name and (channel) format. In Pro Tools, paths are similar to *stems*, known to the film and video industries (see “Stems and Stem Mixes” on page 69). The I/O Setup dialog lets you define and name paths according to the needs of each project.

On HD-series systems, the I/O Setup Dialog provides a graphical representation of the signal routing for each connected audio interface, with controls to route physical ports to Pro Tools inputs and outputs. These controls mirror the routing controls found in the Hardware Setup dialog—changes made to physical routing in one dialog are always reflected in the other.

Each Pro Tools system can have a different I/O Setup configuration, determined by:

- Whether it is a Pro Tools LE system or a Pro Tools TDM system
- On TDM systems, whether it is an HD-series, MIX-series, or Pro Tools|24 system
- On TDM systems, the number and types of audio interfaces
- On TDM systems, the mixer plug-in currently installed

Each Pro Tools session retains its path configurations as I/O Settings. The I/O Settings saved with the session are loaded automatically when the session is opened. Unavailable items (including hardware, paths, or required resources) remain in the session as inactive items (see “Active and Inactive Paths” on page 78).

When you create a new session, you can specify a default I/O Setup configuration, including presets for stereo or multichannel mixing formats (multichannel mixing requires an HD-series or MIX-series system).

The I/O Setup dialog also lets you save and import I/O Settings files.

## Paths in Sessions

In sessions, audio is routed using the track Input, Output, Insert, Plug-in, and Send Selectors. These selectors let you assign tracks to hardware inputs and outputs, internal busses, and other Pro Tools signal paths.

Paths comprise the lists of available signal routing choices in track input, output, insert and send selectors.

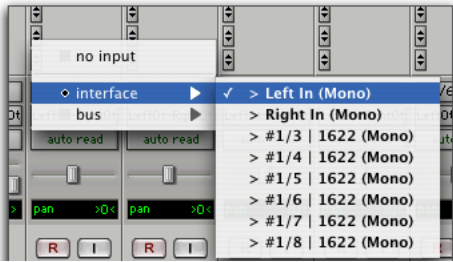

Track Input Selectors

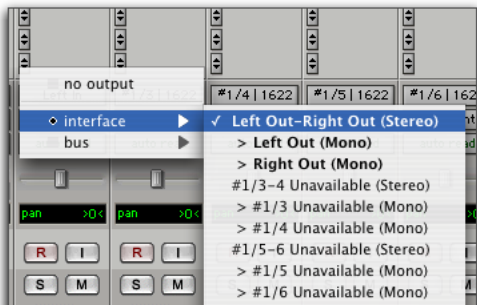

Track Output Selectors

## Paths and I/O Setup

The signal routing choices available in a session are defined in the I/O Setup dialog.

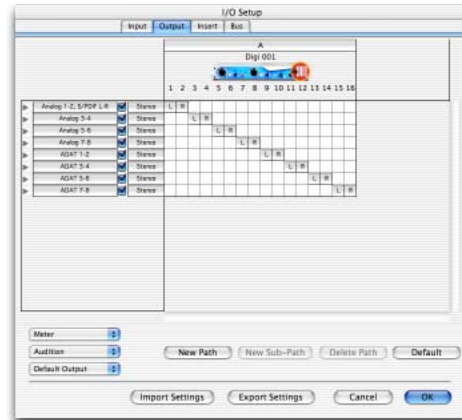

I/O Setup dialog Output paths on a Digi 001 system (Pro Tools 6.2)

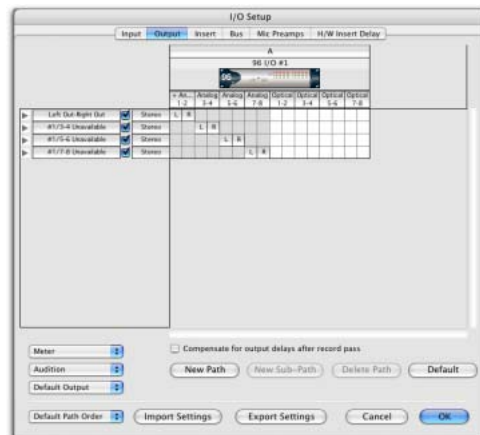

I/O Setup dialog Output paths on an HD system (Pro Tools 6.4)

## Main Paths and Sub-Paths

Paths in the I/O Setup dialog include *main paths* and *sub-paths*.

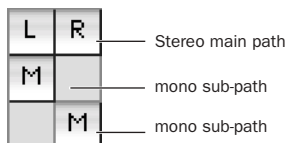

*Main and sub-paths in the I/O Setup Channel Grid*

### Main Paths

*Main paths* are logical groupings of inputs, inserts, busses, or outputs. For example, a master stereo output path could be named Main Out. Path names in a stereo path are often appended with “.L” and “.R” for left and right.

### Sub-Paths

A *sub-path* represents a signal path within a main path. For example, a default stereo output path consists of two mono sub-paths, left and right. Mono tracks and sends can be routed to either mono sub-path of the stereo output path.

 *It is especially useful to define and name sub-paths for complex mixing setups, such as a 5.1 Surround mix.*

### Default I/O Settings

A default I/O Settings file is installed automatically by Pro Tools, so you have a set of default paths that will get you started, without the need to configure the I/O Setup dialog. You can then customize your I/O Setup configuration at any time, according to the needs of each project (see “The I/O Setup Dialog” on page 70).

## Default Settings Files

The default Stereo settings file is available on all Pro Tools systems, and provides stereo main paths, each with its own mono sub-paths.

Multichannel settings files are available for Pro Tools HD-series and MIX-series systems. These settings provide specialized path definitions for surround mixing. See “Configuring Pro Tools for Multichannel Sessions” on page 508.

### Default Path Names

Default names for input, output, and insert paths are based on the type of system (LE systems) or type and number of interfaces (TDM systems) you are using.

## Stems and Stem Mixes

The use of stems and stem mixes originated in the post production industry as a method to organize and manage elements of a mix by type or content.

For example, a film mix often requires a stem mix for Foley, a stem mix for sound effects, a stem mix for dialog, and another for music. In this scenario, the dialog stem would contain all the dialog elements mixed relative to each other. The dialog stem can then be mixed with the other stems during the final mix of the scene or reel. The final mix is simplified by the ability to control the level of each stem, rather than the multitude of individual tracks that comprise a typical film mix.

In Pro Tools, you can work with main and sub-paths as you would stem mixes. These can be assigned as needed, including the ability to assign multiple outputs to individual tracks and sends. For more information, see “Multiple Output Assignments” on page 412.

## The I/O Setup Dialog

The I/O Setup dialog defines Pro Tools input, output, insert, and bus paths. Routing I/O ports to Pro Tools inputs and outputs can also be done here.

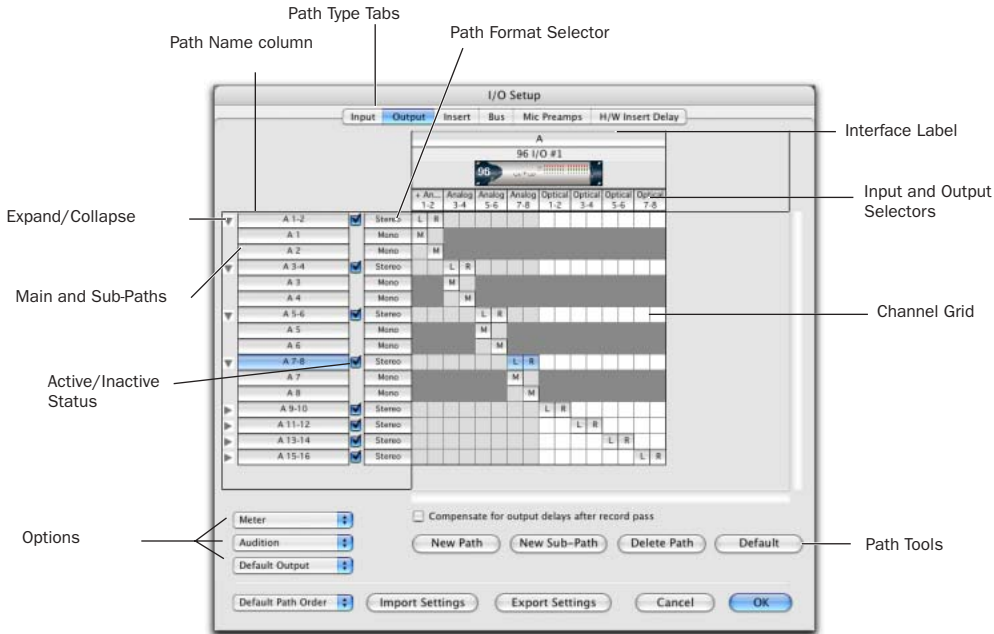

Figure 5. I/O Setup dialog on a Pro Tools|HD system with a 96 I/O

### To open the I/O Setup dialog:

- 1 Make sure your audio interfaces are enabled and configured properly in the Hardware Setup. See “Configuring Pro Tools Hardware Settings” on page 41.
- 2 Choose **Setup > I/O Setup**.

### To open the Input, Output, Insert, Bus, Mic Preamps, or H/W Insert Delay page in the I/O Setup dialog:

- Click the corresponding tab at the top of the I/O Setup dialog.

### Closing the I/O Setup Dialog

You can click **Cancel** at any time to close the I/O Setup dialog. When you click **OK**, Pro Tools checks several settings for routing validity (to prevent feedback loops). If there are any overlapping or invalid settings, you will be required to correct them before the I/O Setup dialog will close. For more information, see “Initializing I/O Setup” on page 77.

## I/O Setup Dialog Controls

This section provides an overview of the controls in the I/O Setup dialog.

**Path Type Tabs** Select the type of I/O to configure. Choices are Inputs, Outputs, Inserts, or Buses.

**Input and Output Selectors** Select the physical ports on your audio interface to route to Pro Tools inputs and outputs. Ports are selectable in channel pairs. Available ports for each displayed interface are based on Hardware Setup settings; for example, if the AES/EBU inputs and outputs of an interface are enabled in Hardware Setup, they are available for routing in I/O Setup. The functionality provided with the Input and Output Selector is the same as that provided on the Main page of the Hardware Setup dialog.

**Path Name Column** Shows paths that are available for selection, including the name of each defined path.

**Expand/Collapse** Shows or hides the sub-paths associated with a main path.

**Active/Inactive Status** Shows and changes the active/inactive status of each path.

**Path Format Selector** Shows and selects the type/format (such as Mono, Stereo, Quad, or 5.1) of each defined path.

**Channel Grid** Maps paths to specific interfaces and channels.

**Compensation for Input and Output Delays** Allows automatic compensation for input and output delays caused by Digidesign analog-to-digital and digital-to-analog hardware.

**Path Tools** Customize the I/O Setup configuration. Buttons include: New Path, New Sub-Path, Delete Path, and Default.

**Show Original Setup** Appears in the I/O Setup dialog in certain session transfer situations. For details on this feature, see “Show Original Setup and Show Current Setup” on page 80.

**Options** Provide pop-up menus to set paths or orders for Meter, Audition (Regions List previewing), Default Output (for new tracks), and Default Path Order. See “I/O Setup Options” on page 82.

## Routing Hardware I/O to Pro Tools I/O

The I/O Setup dialog lets you define which physical ports on your I/O peripheral are routed to available inputs and outputs in Pro Tools. Use the Input and Output Selectors in the I/O Setup dialog to serve as a patchbay to route any of the physical inputs or outputs to your Pro Tools mixer.

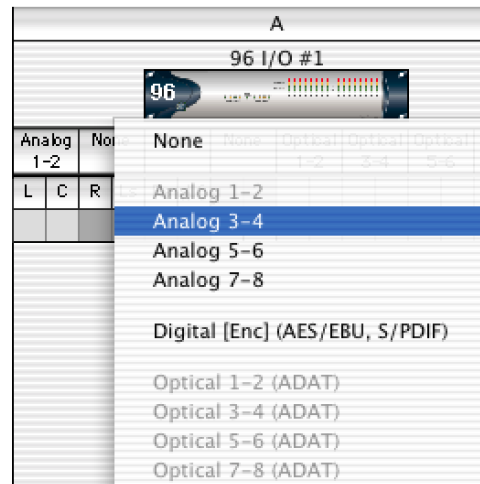

*I/O Channel Selector pop-up menu*

### **To configure I/O routing in I/O Setup:**

- 1 Choose Setups > I/O Setup.
- 2 Click the Input or Output tab to display the corresponding path type.
- 3 Click the Input or Output Selector for the first interface channel pair, located below the first audio interface icon.
- 4 From the pop-up menu, select a physical port pair (such as Analog 1–2), to route to a Pro Tools channel pair (such as A 1–2) in the Path Name column on the left.
- 5 Repeat the above step for additional channel pairs.
- 6 Click OK.

### **Routing a Pro Tools Output Pair to Multiple Destinations**

Pro Tools channel pairs can be routed to multiple outputs on an audio interface through the I/O Setup dialog. For example, if you assign both Analog 1–2 and Analog 3–4 interface outputs to Pro Tools Output pair 1–2, when you send a signal to Pro Tools Outputs 1–2, that signal will be routed simultaneously to both pairs of output ports on your audio interface.

This lets you send the same signal (such as a stereo pair, a stem mix, or a multichannel mix) to multiple destinations (such as multiple mastering devices).

The only limit to output choices is the number of outputs available in your system.

 *Output path assignments cannot overlap. See “Valid Paths and Requirements” on page 77 for details.*

Pro Tools outputs pairs can also be routed to multiple audio interface outputs in the Hardware Setup dialog. For more information, see “Routing a Pro Tools Output Pair to Multiple Destinations” on page 44.

### **To route a Pro Tools output channel pair to multiple audio interface output ports:**

- 1 Choose Setups > I/O Setup.
- 2 Click the Output tab.
- 3 Click the Output Selector for an interface channel pair, just below an audio interface icon.
- 4 From the pop-up menu, select a physical port pair (such as Analog 1–2) to route to the corresponding Pro Tools channel pair (such as A 1–2) in the Path Name column on the left.
- 5 Start-click (Windows) or Control-click (Macintosh) the same Output Selector and select an additional output pair from the same pop-up menu.

The output name updates with a plus sign (“+”) before it to indicate that multiple output ports are selected. In the pop-up menu, each physical port pair assigned to that Pro Tools output pair is indicated by a check mark.

- 6 Repeat the above steps to select additional output destinations.
- 7 Click OK.



## Creating and Editing Paths

The I/O Setup dialog lets you create and customize signal path definitions.

Paths can be:

- Renamed, for easier identification after changing or renaming audio interfaces
- Remapped, to or from different sources or destinations
- Deactivated (or reactivated) to manage unavailable or unnecessary I/O resources
- Deleted

In addition, you can import and export your I/O Setup configurations as I/O Settings files, as well as set default path parameters.

The following table lists the available path attributes for each path type.

### Path Options by Type

Path Type	Path Options (Attributes)
Input	Names, formats, and source channel (analog or digital audio interface, or CPU input)
Output	Names, formats, and destination (audio interface output channel or internal send bus)
Insert	Names, formats and destination (audio interface channels)
Bus	Names and formats

### Creating a Default Main or Sub-Path

You can set an I/O Setup path type to its default path configuration at any time.

#### To restore default paths and pathnames:

- 1 Choose Setups > I/O Setup.

- 2 Click the Input, Output, Insert, or Bus tab to display the corresponding path type.

- 3 Click Default.

Pro Tools creates all possible stereo main paths. Mono sub-paths are also auto-created for every stereo main path. These default path names appear in a session's track Input and Output Selectors.

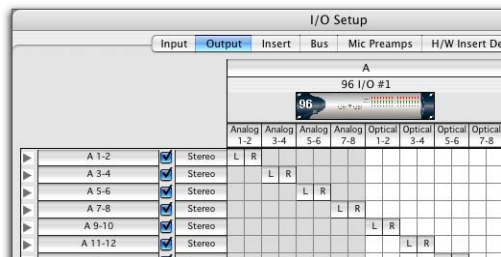

Default stereo output paths

 To optimize Pro Tools DSP resources, it is best to create mono sub-paths for Outputs and Busses, rather than mono main paths.

## Creating New Paths

You can create new main path and sub-paths with custom names, format, and mapping. Custom path names appear in a session's track Input, Output, Insert, and Bus Selectors.

#### To create a new path:

- 1 Choose Setups > I/O Setup.
- 2 Click the Input, Output, Insert, or Bus tab to display the corresponding path type.
- 3 Click New Path, or press Control+N (Windows) or Command+N (Macintosh).

– OR –

Select a main path and click New Sub-Path.

- 4 Double-click in the Name field and enter a name for the path.
- 5 Press Tab to set the new path name and move to the next path's Name Field, or press Enter (Windows) or Return (Macintosh) to set the new path name.
- 6 Choose a format from the Path Format Selector (mono, stereo, or multichannel).

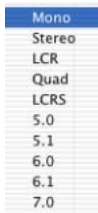

#### Path Format Selector

- 7 Repeat the previous steps to configure other path types (Input, Output, Insert, or Bus).
- 8 Click OK to close the I/O Setup dialog. If there are any overlapping or identically named paths, you will be instructed to correct them before the I/O Setup dialog will close. For more information, see “Initializing I/O Setup” on page 77.

 *Multichannel paths and mixing are explained in Chapter 31, “Pro Tools Setup for Surround.”*

## Selecting and Arranging Paths

Individual and multiple paths can be selected in the I/O Setup dialog Path Name column. Selected paths and sub-paths can be moved higher or lower in the Path Name column to change their menu order in track Input, Output, Insert, and Bus Selectors. Paths can also be deleted. Sub-paths follow their main paths when they are moved in the I/O Setup dialog.

### To select a main path or sub-path:

- Click the path name.

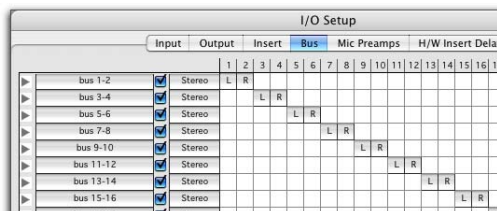

Selecting paths in the I/O Setup dialog

### To select multiple main paths or sub-paths:

- Shift-click the path names.

When all paths are selected, Shift-clicking the path name, deselects it.

### To select all paths and sub-paths:

- Alt-click (Windows) or Option-click (Macintosh) any path name.

When all paths are selected, Alt-clicking (Windows) or Option-clicking (Macintosh) any path name, deselects all path names.

### To rearrange paths:

- Drag one or more path names up or down.

## Resetting Paths

The Default button in the I/O Setup dialog provides two primary functions:

- Creates new, default paths up to the capacity of your system's available audio interfaces and resources. See "Creating a Default Main or Sub-Path" on page 73.
- Resets selected path names to matching or corresponding paths in the current I/O Setup configuration. For example, if you change modes on Digi 001, or replace an audio interface on a Pro Tools HD-series or MIX-series system, you can use the Default switch to update your I/O Setup definitions with the new hardware configuration.

 *Interface names can be customized. See "Changing Interface Names" on page 75.*

### To reset path names:

- Click Default.

If there are matching paths available with the new system configuration, existing paths will be updated to include new audio interfaces (TDM systems), or I/O mode selection (Digi 001 only).

## Resetting Mix Busses (TDM Only)

Pro Tools 5.1.3 and higher supports up to 64 mix busses for TDM systems. However, when you open a session created with Pro Tools 5.0.1 or lower, only 32 busses are initially available.

### To make 64 busses available in sessions created with Pro Tools 5.0.1 or lower:

- 1 Open the I/O Setup dialog.
- 2 Click the Bus tab in the upper left.
- 3 Click Default.

## Changing Interface Names

Audio interface names can be customized in the I/O Setup dialog (Pro Tools TDM systems and Pro Tools 6.1 on LE). On TDM systems only, the I/O Setup dialog then bases default Input and Output path names on the custom names.

### To rename an audio interface in the I/O Setup dialog:

- 1 Double-click the label above an interface.
- 2 Enter a new interface name.
- 3 Press Enter (Windows) or Return (Macintosh).

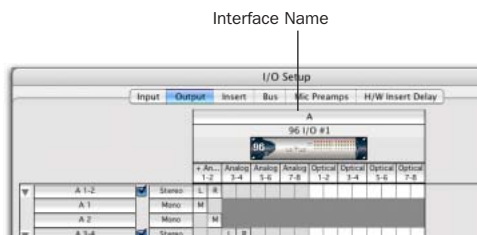

*Interface Names*

## Deleting Paths

Path definitions can be deleted from the current session to reflect changes to your hardware setup, or to clean up track selector menus by removing unwanted or unnecessary path definitions. After deleting a path, any tracks or send assignments to that path are reset to No Output.

### To delete a main path or sub-path:

- 1 In the I/O Setup dialog, select the path you want to delete.
- 2 Click Delete Path.

### To delete all paths:

- 1 Alt-click (Windows) or Option-click (Macintosh) any path name.
- 2 Click Delete Path.

## Channel Mapping

Once a path has been created and formatted, it can be mapped to specific audio interface, or bus channels in the Grid.

### To map channels:

- 1 Select a main or sub-path.
- 2 In the row for the selected path, click in the Grid column under an audio interface and channel. Other channels for the path type, if any, fill to the right.



### Mapping channels

For example, when mapping a new stereo path, clicking in the path row under output channel 1 fills both channel 1 and 2 (left to 1, right to 2).

To remap channels in a path, see “Remapping Channels” on page 76.

## Channel Mapping and Surround Mixer

### (Pro Tools HD-Series and MIX-Series Systems Only)

When mapping multichannel paths, the left channel (L) is mapped first to the clicked Grid box, and remaining channels fill immediately to the right according to the default path order. Because some multichannel mixing formats use unique track layouts, Pro Tools lets you set the default format in the I/O Setup dialog (see “I/O Setup Options” on page 82).

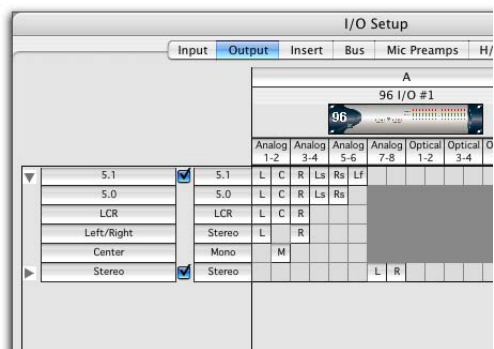

Customized Output paths for a 5.1 mix

## Remapping Channels

You can move the individual assignments to different channels, to reorder the path’s definition (for example, changing a multichannel map to L-R-C-LF-LS-RS).

### To remap channels in a path:

- Drag the channel to the new location in the Grid. Other channel assignments will move (shuffle) to accommodate dragged channels.

## Channel Shuffling

Moving a signal from right to left results in a shuffle of other signals after the new destination channel. Moving a signal from left to right shuffles any and all signals after the new destination channel and leaves the previous channel empty.

 *Changing a path's format erases any current channel mapping.*

## Sub-Paths Follow Main Paths

When a main path is remapped, its sub-paths (if any) will remap automatically to maintain consistent routing. For example, remapping a stereo path to different hardware outputs results in any of its sub-paths moving with it.

## Initializing I/O Setup

**To set the current I/O Setup configuration:**

- Click OK in the I/O Setup dialog.

All paths must be valid before the I/O Setup configuration can be applied.

## Valid Paths and Requirements

While configuring the I/O Setup window, certain rules apply for path definition and channel mapping.

Though it is possible to set up invalid mappings in the Channel Grid, Pro Tools will not accept an I/O Setup configuration unless all paths meet the path definition and channel mapping requirements, as follows:

**Minimum Path Definitions** All paths must have a name, be of a specific format, and have a valid I/O mapping.

**Overlapping Channels and Valid Paths** Channel mapping follows certain rules regarding overlapping paths.

- There can be no partial or complete overlaps between any two main Output paths, any two Insert paths, or any two main Bus paths.
- A newly-created Output or Bus path must either be completely independent of other maps (not mapped to any other available I/O interface/channels), or it must be a sub-path completely contained within a larger path (for example, an LCR sub-path within a larger 5.1 path).
- Output and Insert paths can overlap in I/O Setup, but only one or the other can be used at any given time in a session. (Inputs, however, can be routed to multiple tracks.)

## Active and Inactive Paths

Pro Tools paths can be Active (on) or Inactive (off, or unavailable). You can manually switch paths between Active or Inactive on a track-by-track or session-wide basis. In addition, Pro Tools sets paths to Inactive automatically when I/O is unavailable.

**Track Path Assignments** Track input, output, and bus path assignments can be switched to Inactive using the corresponding selector on the track. This leaves track playlists intact, while disconnecting that particular track from the output or bus path. Use this to remove a track from a signal path.

**Session-Wide Path Assignments** Paths can be globally activated or deactivated in the I/O Setup window. Use this to turn off a signal path on any and all tracks currently assigned to it. Pro Tools also sets unavailable paths to inactive. Paths can be unavailable when hardware or other system resources are unavailable, such as when opening a session saved on a different system.

## Track Path Assignments

### (Mix and Edit Windows)

**To toggle a track path assignment to be Active or Inactive:**

- In the Mix or Edit window, Control-Start-click (Windows) or Command-Control-click (Macintosh) the track's Input, Output, Insert, or Send Selector.

Inactive track path assignments are listed in italics and are unhighlighted.

## Toggle All or All Selected

The Alt (Windows) and Option (Macintosh) modifiers apply the path toggle to all tracks. The Alt+Shift (Windows) and Option+Shift (Macintosh) modifiers apply the path toggle to all selected tracks. However, Pro Tools will only apply the change to identical path assignments, if any, in the current track or tracks. Toggling multiple tracks only affects tracks that have the same path assignment as the one you are explicitly toggling.

## Toggle Multiple Paths

If a track has only one main output assignment, you can Control-start-click (Windows) or Command-Control-click (Macintosh) the track's Output Selector to toggle the main output to inactive. When there are multiple assignments, the track selector will be displayed for you to specify the input, output, insert, or bus path.

If a Send (A–E) has multiple output assignments and one of those is toggled, then *all* of the output assignments for that Send (A–E) will be toggled.

## Session-Wide Path Assignments

### (I/O Setup Dialog)

Paths can be globally configured for Active or Inactive status in the I/O Setup Dialog.

### Display of Active and Inactive Status

**Unhighlighted (Italics)** Indicates the path is inactive.

**Highlighted (Non-Italics)** Indicates the path is active.

**Highlighted (Italics)** Indicates the path is active, but there are not enough system resources available.

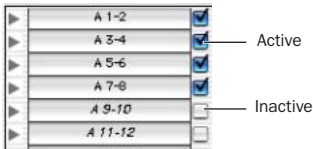

Active and inactive path settings in I/O Setup

### To globally activate or deactivate a path:

- 1 Choose Setups > I/O Setup.
- 2 Select a path type using the tabs at the top of the window.
- 3 Set the Active/Inactive control for the path.

 Any track path assignment can also be deactivated on a track-by-track basis. See “Track Path Assignments” on page 78.

Inactive paths are displayed in italics in the track path selectors.

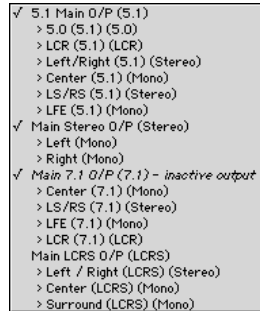

Active and inactive paths in a track Output Selector

## Hardware Setup and Session Transfer

Sessions created in Pro Tools 5.1 or higher store the *type* and *order* of audio interfaces connected and active when the session was last saved.

### Unavailable I/O

When opening a session, Pro Tools checks to see if the hardware configuration has changed since the session was last saved. If the current hardware configuration differs from that saved in the session, paths associated with the unavailable I/O are made inactive.

### Remapping

Remapping occurs when a session’s original I/O Setup does not match that of the current system and session paths are remapped to current hardware.

Systems of equivalent I/O capability are remapped directly. For example, a session tracked to a Pro Tools HD-series system through two 192 I/O audio interfaces would include 32 input paths spread across the two 16-channel interfaces. The session is taken to a second Pro Tools system that has a 96 I/O audio inter-

face (a 16-channel I/O unit) and a 1622 I/O (with its 16 analog inputs) connected to its Legacy Port. When the session is first opened on the second system, Pro Tools will map the 32 input paths to the inputs of the two interfaces.

When hardware is unavailable to a session being opened, assignments can either be replaced using the remap option, or opened as Inactive. Any tracks left assigned to an unavailable path will not be audible. This can be beneficial, however, when you want to reassign tracks into your system's mix one at a time.

 See “Active and Inactive Paths” on page 78 for more information.

### **Show Original Setup and Show Current Setup**

When a session is opened that contains path definitions for unavailable I/O interfaces, the I/O Setup dialog lists those paths in italics.

The Show Original Setup button displays the audio interfaces used in the original session. This temporary display lets you check the original I/O configuration for reference while configuring the session for your system.

Once a session has been opened with unavailable I/O retained, you can then reassign tracks to available I/O paths.

 To redefine the paths, see “Creating and Editing Paths” on page 73.

---

## **I/O Settings Files**

I/O Settings can be managed when transferring sessions, and when developing I/O Setup configurations over the course of multiple sessions and projects.

### **Defaults, Settings Files, and Last Used Settings for New Sessions**

When creating new sessions, you can set the session's I/O Setup configuration using the following options:

**Default I/O Setups** The Pro Tools Installer provides factory presets for stereo and surround I/O Setups (surround mixing is only supported on Pro Tools HD-series and MIX-series systems). See “Factory I/O Settings Files” on page 82 for more information.

**Custom Presets** You can store and recall custom presets using the export and import features of the I/O Setup dialog.

**Last Used** The most recent (or *last used*) I/O Setup configuration is saved as a Last Used settings file. See “Last Used I/O Settings” on page 81 for more information.

### **Default I/O Settings at First Launch**

The first time you create a session, you can choose default Stereo Mix or Surround Mix settings, depending on your system and installation choices. See “Factory I/O Settings Files” on page 82.



## Importing and Exporting I/O Settings Files

You can export and import I/O Setup configurations as I/O Settings files. This lets you save settings for different projects, import settings for reconfiguring I/O Setup, and manage path definitions and signal routing setups.

### Exporting I/O Settings

#### To export and save an I/O Setup configuration:

- 1 Click Export Settings.
- 2 Name and save the settings file.



*To start sessions with a blank or empty I/O Setup dialog, you can create and export an I/O Settings file in which all definitions have been deleted.*

### Importing I/O Settings

I/O Settings can be imported before you open a session, or you can import settings into a session that is already open (see “Default I/O Settings at First Launch” on page 80).

When you import I/O Settings in an existing session, you can choose to delete any unused path definitions before importing the new paths, or leave unused path definitions intact and add the new paths to the current I/O Setup configuration.

#### To import I/O Settings:

- 1 Click Import Settings in the I/O Setup dialog.
- 2 Select an I/O settings file in the Import Settings dialog and click Import.

3 A dialog appears asking whether you want to delete existing paths. Do one of the following:

- Click Yes to remove any unused paths and add the imported paths to the current I/O Setup configuration. Any I/O assignments and automation data associated with the unused paths are also deleted.
- Click No to add the imported paths to the current I/O Setup configuration.

If the import results in overlapping paths, the new paths will appear in the I/O Setup dialog as Inactive. (See “Active and Inactive Paths” on page 78.)

After importing I/O Settings, you can then reassign path routing definitions in the I/O Setup dialog by remapping, renaming, and deleting paths. (See “Creating and Editing Paths” on page 73.)

### Last Used I/O Settings

If any changes are made to the I/O Setup dialog during a session, these changes are saved to the Last Used settings file when the I/O Setup dialog is closed (by clicking OK).

Changes to I/O Setup are saved along with the current session. User Presets files will not contain recent changes unless you export an updated settings file.

The Last Used settings are available as a choice when creating or opening sessions, in addition to the factory presets described below.

## Factory I/O Settings Files

Pro Tools provides I/O Settings files for Stereo and Surround mixing. These files provide generic main and sub-path definitions for either mixing format.

### Stereo Mix Settings File

The Stereo Mix preset consists of all possible stereo and mono paths for your session.

 *Using the “Stereo Mix” preset has the same effect as clicking Default for every individual tab in I/O Settings. See “Creating and Editing Paths” on page 73 for details.*

Specifically, the Stereo Mix preset will create the maximum number paths of each type, as determined by the available system’s I/O Setup and hardware configuration.

### Surround Mix Settings File (TDM Systems Only)

The Surround Mix provides additional, surround-specific Output and Bus presets. See “Surround Mix Settings Files” on page 509 for more information.

## About Direct Outputs Mode

Direct Outputs mode, as found in older versions of Pro Tools, has been replaced by the default mono sub-paths available through all valid I/O in the I/O Setup dialog.

The Default switch creates main Output paths with appropriate mono sub-paths. These sub-paths provide discrete monophonic routing.

When a session is opened that was saved in Direct Outputs mode, Pro Tools maps all the output assignments to equivalent mono sub-paths (as available). See “Hardware Setup and Session Transfer” on page 79 for more information on remapping.

To convert a session so that it emulates Direct Outs mode, use the Auto Assign Ascending Outputs feature, as follows:

### To auto assign track outputs for Direct Out:

- 1 Make sure that all tracks you want to assign are visible (hidden tracks will not be affected).
- 2 Select the tracks you want to assign by Shift-clicking their track names.
- 3 Control-Alt-click (Windows) or Command-Option-click (Macintosh) the Output Selector of the leftmost track and assign it to the sub-path for Output #1. All visible tracks will be auto-assigned to unique mono sub-path outputs in ascending order.

---

## I/O Setup Options

Pro Tools systems have additional I/O Setup features. These include default signal routing for metering and auditioning, and default track layout for multichannel mix formats.

## Meter Path Selector

### (ProControl Only)

The Meter Path Selector determines the path displayed across the ProControl Output meters. See the latest ProControl documentation for more details.

## Audition Path

The Audition path is the output path through which files and regions are previewed (listened to) in the Regions List.

## Using the Default Audition Path

When you audition a file or region in the Regions List, Pro Tools routes the audio output through the Audition path. Pro Tools assigns a default Audition path to the first available main Output path of the corresponding format. You can also select a different Audition Path in the I/O Setup dialog.

 *On TDM systems with more than one audio interface, you can only select the first audio interface as an audition path.*

## Configuring Audition Paths

You can specify the monitoring outputs for Regions List auditioning using the Audition paths menu.

**Audition Path Main Menu** The main menu consists of all path format choices available on the current system (Mono and Stereo on all systems, LCR and greater on HD-series and MIX-series systems).

**Audition Path Submenus** Each path format choice has a submenu listing Output paths of that given format. (The mono submenu lists Output paths of any format.)

### To configure Audition paths:

- Select a path from the Audition path menu or submenus.

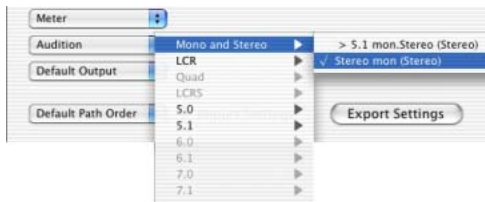

Selecting an Audition path

### To audition regions in the Regions List:

- Alt-click (Windows) or Option-click (Macintosh) the region in the list.

## Auditioning Discrete Signals in Multichannel Items

In the Audio Regions List, multichannel regions are auditioned through the current Audition path. Signals can be auditioned “in-place,” or through all outputs, as described below.

### Audition In-Place

When auditioning a mono component of a multichannel region, that mono component will by default be auditioned *in-place*. That is, it will play from the corresponding speaker channel of its parent multichannel region.

### To audition in-place:

- 1 In the Regions List, make sure the stereo or multichannel region is in expanded view (showing .L, .R, and other component channels).
- 2 Alt-click (Windows) or Option-click (Macintosh) the region for the channel you want to audition.

### Audition to All Outputs

Mono regions can be routed equally to all outputs of the parent region’s Audition path.

### To audition through all channels of the main audition path:

- Shift-Alt-click (Windows) or Shift-Option-click (Macintosh) on the signal in the Regions List.

## Default Path Order

(TDM Systems Only)

The Default Path Order Selector lets you select the default track layout you want Pro Tools to follow when creating and mapping 5.1-format main or sub-paths in the I/O Setup dialog.

This setting does not affect existing path definitions or metering—it only specifies channel mapping in new 5.1-format paths.

### To choose a Default Path Order:

- Select the channel mapping from the Default Path Order menu.

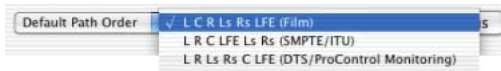

### Default Path Order Selector

For more information about multichannel mixing, see Chapter 31, “Pro Tools Setup for Surround.”

## Default Output Path

You can specify the default Output path assignment for new tracks, in each available format.

### To specify a default Output in the I/O Setup window:

- Select a format and Output path from the Default Output Selector.

---

## H/W Insert Delay Compensation

(TDM Systems Only)

You can specify the latency of outboard hardware (such as effects devices) in the H/W Insert Delay page of the I/O Setup Dialog. You can enter hardware insert latency, in milliseconds, in a field that corresponds to every input/output pair. These times will be used by the Delay Compensation Engine to time align input paths when a hardware insert is used.

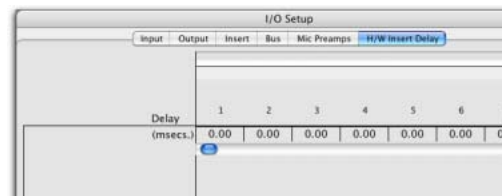

### To set an insert delay offset:

- Enter a value, in milliseconds, in the field corresponding with the input where the hardware insert is connected.

**⚠** *Insert delay offsets only have an effect when the I/O is used for hardware inserts.*

# Chapter 8: Tracks

This chapter covers basic track management tasks such as creating and deleting tracks, assigning voices and output channels, and grouping tracks.

---

## Track Types

In a Pro Tools session, you can have several different types of tracks. These can include audio tracks, Auxiliary Input tracks, MIDI tracks, Master Fader tracks, and Avid or QuickTime Movie tracks. AVoption|V10 Movie tracks are supported on Pro Tools 6.4 and higher.

AVoption|XL Movie tracks are supported on Pro Tools 5.3.3 and higher (Windows), and Pro Tools 6.1 and higher (Macintosh).

 *QuickTime Movie track features are described in Chapter 36, “Working with QuickTime Movies.”*

### **Audio Tracks, Auxiliary Input Tracks, and Master Fader Tracks**

Pro Tools provides mono, stereo, and greater-than-stereo multichannel format audio tracks, Auxiliary Inputs, and Master Faders.

### **Audio Tracks**

Audio tracks contain arrangements of recorded (or imported) audio files. Audio tracks can be mono, stereo, or multichannel format (multichannel tracks are supported on Pro Tools HD-series and MIX-series systems only).

### **Auxiliary Input Tracks**

Auxiliary Input tracks can be used as effects sends, destinations for submixes, as a bounce destination, as inputs to monitor or process audio (such as audio from MIDI sources), and for many other audio routing tasks.

### **Master Fader Tracks**

Master Fader tracks control the overall level of the audio tracks that are routed to the session's main output paths. For example, you could have 24 tracks in a session with channels 1–8 routed to Analog Output 1–2, channels 9–16 to Analog Output 3–4, and channels 17–24 to Analog Output 5–6. You could then create three master faders, one to control each of these output pairs.

Master Fader tracks have additional uses (such as controlling submix levels). For more information, see “Master Faders” on page 406

## **MIDI Tracks**

MIDI tracks store MIDI note, instrument, and controller data. You cannot select a track format when you create a MIDI track, because audio does not pass through it.

## **Track Formats**

### **Mono Tracks**

A mono audio track, Auxiliary Input, or Master Fader track controls volume, and, in some cases, panning, for a single channel of audio. A mono track uses a single voice.

### **Stereo Tracks**

A stereo audio track, Auxiliary Input, or Master Fader track is a single channel strip that plays two channels of audio as a stereo pair. Stereo tracks use two voices.

## **Multichannel Tracks (Pro Tools HD-Series and MIX-Series Systems Only)**

A multichannel track is a single channel strip that plays multiple channels of audio (from 3–8 channels at a time). This allows Pro Tools to support multichannel mixing formats including LCRS, 5.1, 6.1, and others.

For more information on surround mixing with Pro Tools, see the following chapters:

- Chapter 31, “Pro Tools Setup for Surround”
- Chapter 32, “Multichannel Tracks and Signal Routing”
- Chapter 33, “Surround Panning and Mixing”

## **Audio Track Channel Strips**

Each audio track has its own set of controls for volume, pan, output window, record enable, automation mode, solo, mute, and voice assignment. Audio tracks also have a Comments View to enter and display comments.

With slight variations, audio track channel strips in the Mix window look like the tracks shown in the following figures.

Audio tracks can be added to a session with the New Track command.

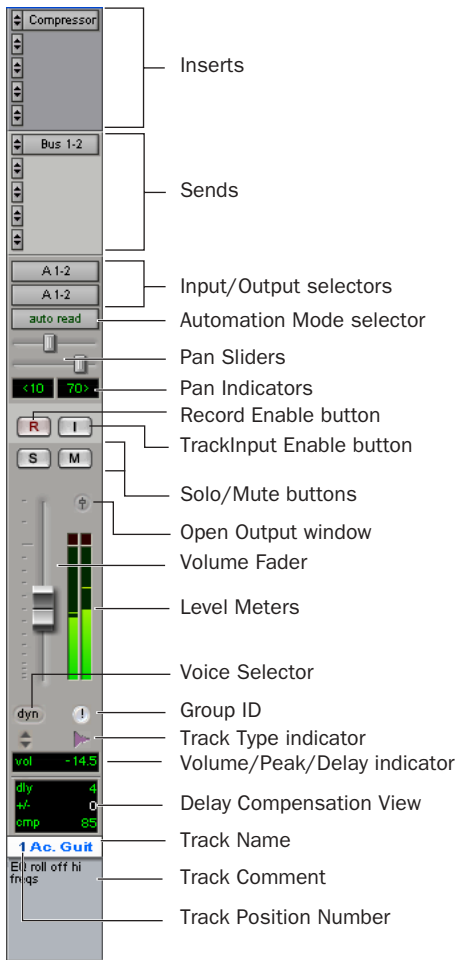

Stereo audio track channel strip (Pro Tools 6.4)

## MIDI Track Channel Strips

Each MIDI track has its own set of controls for volume, pan, record enable, automation mode, solo, mute, MIDI patch assignment, and MIDI channel assignment. MIDI tracks also have a Comments View to enter and display comments.

MIDI tracks can be added to a session with the New Track command.

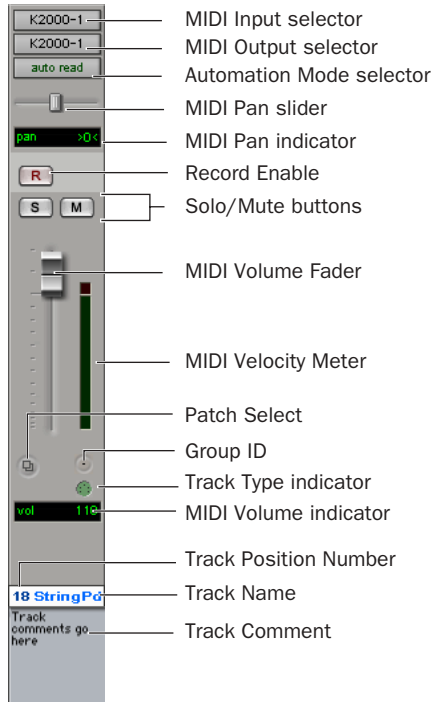

MIDI channel strip (Pro Tools 6.4)

---

## Track Controls

### Input/Output Selectors

The I/O View shows Input and Output Selectors on audio and MIDI tracks.

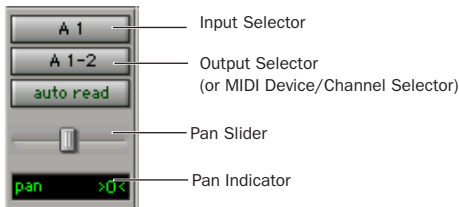

*Inputs/Outputs View*

#### To show the I/O View:

- Select Display > Edit Window Shows (or Mix Windows Shows) > I/O View.



*In Pro Tools 6.x, channel strips in the Mix window always display Input and Output Selectors as well as volume and pan values, so there is no I/O View display option for the Mix window.*

For details on Input and Output Selectors, see “Assigning Inputs and Outputs to Tracks” on page 95.

### Volume/Peak/Channel Delay Indicator

The Volume indicator on an audio track has three display modes: Volume, Peak, and Channel Delay.

#### To toggle the Volume indicator display:

- Control-click (Windows) or Command-click (Macintosh) the indicator to toggle it between the following modes:

**Volume Indicator** Shows the current volume, or input level of a track as set by the track Volume fader.

**Peak Indicator** Functions as a headroom indicator based on the last peak playback level. To reset the peak counter, click anywhere in the meter. Values range from  $-\infty$  (no signal) to 0 dB.

**Channel Delay Indicator** Shows the total delay, in samples, incurred on the track from the use of any TDM plug-ins on that channel.

### Pan Indicator

The Pan Indicator displays the current pan setting of a track. Pan values range from <100 (full left) to 100> (full right). Pan controls are only available for stereo tracks or for mono tracks routed to a stereo output.

### Pan Slider

The Pan slider controls the balance of a track between the assigned output pair. It only appears if you are using stereo tracks or mono tracks routed to a stereo output.

The Pan slider on a MIDI track is effective only if you are controlling a sound module that supports MIDI panning.

### Volume Fader

The Volume fader controls the volume of a track when it is in playback, and the monitor level of the track when it is in record. You can link the record and monitor levels by enabling the Operation Preference for “Link Record and Play Faders.”

The maximum fader gain for volume faders can be set to either +6 dB or +12 dB for Pro Tools 6.4 or higher. Earlier versions of Pro Tools have a maximum fader gain of +6 dB.



## Selecting Fader Gain when Opening a Previously Recorded Session

When opening a session created in a previous version of Pro Tools, you are given the choice of staying at +6 dB or updating to +12 dB.

When opening a session created in Pro Tools 6.4, the session is opened with your previously saved fader gain settings.

**Opening a +12 dB session in a previous version of Pro Tools** Sessions created and saved with a +12 dB fader gain level can be opened in previous versions of Pro Tools. Breakpoints for volume automation above +6 dB will be lowered to +6 dB.

The volume fader on a MIDI track is effective only if you are controlling a sound module that supports MIDI volume.

## Track Level Meter

On audio tracks, level meters indicate the level of the signal being recorded or played back from the hard drive. Green indicates nominal levels; Yellow indicates pre-clipping (–6 dB below full scale); and Red indicates clipping. When a track is record-enabled, these meters indicate record levels.

On MIDI tracks, the level meter shows the MIDI velocity of the most recent MIDI event.

### Pre- and Post-Fader Metering

You can globally set audio track level meters to indicate pre-or post-fader levels by selecting or de-selecting Operations > Pre-Fader Metering. When pre-fader metering is selected, the level meters show levels independent of fader position. With post-fader metering, the level meters respond to fader position.

## Peak Hold

Pro Tools meters provide a Peak Hold feature with three options: 3 Second, Infinite, or None.

### To choose a Peak Hold setting:

- 1 Choose Setups > Preferences.
- 2 Click display.
- 3 Select a Peak Hold option.
- 4 Click Done.

### To clear a meter:

- Click anywhere on the meter.

### To clear all meters do one of the following:

- Alt-click (Windows) or Option-click (Macintosh) any meter.
- Choose Operations > Clear All Clips.
- Press Alt-C (Windows) or Option-C (Macintosh).

## Clip Indication (Pro Tools 6.4)

Pro Tools 6.4 meters provide Clip Indication with three options: 3 Second, Infinite, or None. If clipping occurs, the topmost LED will stay lit (red).

 *Clip indicators appear in plug-in, send, and track windows.*

### To choose a Clip Indication setting:

#### To choose a clip setting:

- 1 Choose Setups > Preferences.
- 2 Click display.
- 3 Select a Clip Indication option.
- 4 Click Done.

### To clear a clipping meter:

- Click anywhere on the meter.

### To clear all clips:

- Alt-click (Windows) or Option-click (Macintosh) any meter.

### To clear all clips (Pro Tools 6.4 and higher):

- Choose Operations > Clear All Clips.
- Press Alt-C (Windows) or Option-C (Macintosh).

## Wide Meters View

### (Pro Tools 6.x Only)

Wide Meters View expands the width of the level meters for tracks in both the Mix and Edit windows, to make the track level meters easier to read. Wide Meters View also supports Narrow Mix View.

### To enable Wide Meters View:

- Command-Option-Control-click the track level meters in either the Mix window or the Edit window.

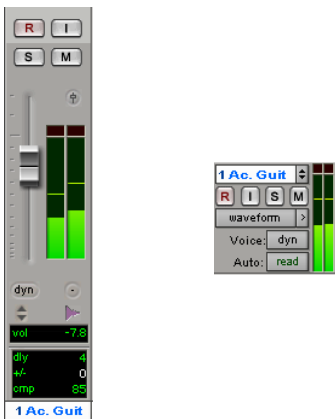

Wide Meters View, Mix and Edit windows

### To disable Wide Meters View:

- Command-Option-Control-click the track level meters a second time in either the Mix window or the Edit window.

## Delay Compensation View

### (HD-series Systems with Pro Tools 6.4 Only)

The Delay Compensation View displays the total amount of plug-in delay on each track, lets you apply a user offset of track delay, and displays the total amount of delay that Pro Tools applies to each track. The Delay Compensation View can be shown in the Mix Window.

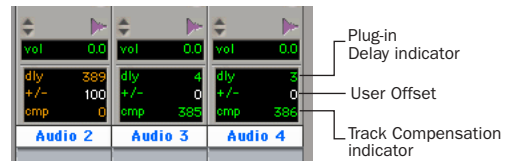

Delay Compensation view

### To view Delay Compensation information:

- Choose Display > Mix Window Shows > Delay Compensation View.

Delay values can be specified in either samples or milliseconds, as set in Display Preferences.

 For more information, see “Delay Compensation” on page 428.

## Track Comments View

Comments View shows any comments entered in the Track Name/Comments dialog. You can also type directly in the Track Comment area for each track when it is displayed. For details, see “Naming Tracks” on page 91.

### To display the Comments View:

- Select Display > Mix Window Shows (or Edit Window Shows) > Comments.

## Creating Tracks

On all systems, you can create mono and stereo tracks. In addition, on Pro Tools HD-series and MIX-series systems, you can create multichannel tracks.

When new tracks are created, they are given a default name which can be changed at any time.

- ◆ For new tracks to appear next to a specific track in a session, select that track by clicking its name (in its track channel strip). The new tracks are added immediately after the selected track.
- ◆ For new tracks to appear as the last tracks in a session, make sure that no track names are selected on-screen.

### To create a new track:

- 1 Choose File > New Track.

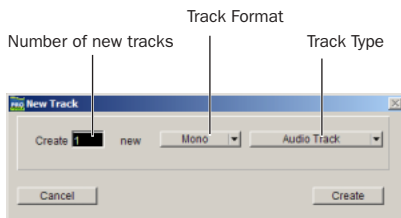

### New Track dialog

- 2 Select the type of track you want to add from the Track Type pop-up menu. For explanation of track types, see “Track Types” on page 85.

 To auto-scroll the Track Type pop-up in the New Track dialog, press Control (Windows) or Command (Macintosh) and use the Up/Down Arrow keys.

- 3 Select the track format (mono, stereo, or one of the multichannel surround formats) from the Track Format pop-up menu. Surround formats are available only on Pro Tools HD-series and MIX-series systems.

 To auto-scroll the format selector, press Control (Windows) or Command (Macintosh) and use the Left/Right Arrow keys.

- 4 Enter the number of new tracks, then click Create.
- 5 To configure which track controls appear in the Mix window or Edit window, select from Display > Mix Window Shows and Display > Edit Window Shows.

## Naming Tracks

Track names are used to auto-name recorded audio files and regions (see “Default Track Names” on page 144).

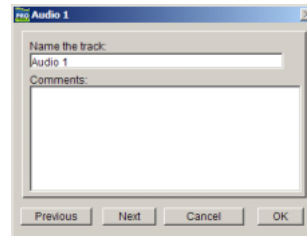

### Track Name/Comments dialog

### To rename a track:

- 1 In the Edit window or Mix window, double-click the Track Name button for the track you want to rename.
- 2 In the Track Name/Comments dialog, type a new track name.

3 Click Previous or Next to rename other displayed tracks.

 To move to the previous or next track in the Track Name/Comments dialog, you can press Control (Windows) or Command (Macintosh) and use the Up/Down or Left/Right Arrows.

4 Click OK.

## Adding Comments to Tracks

### To enter comments for a track:

- From the track channel strip, click directly in the Comments area, type any comments for the track, and press Enter (Windows) or Return (Macintosh).

– or –

- In the Edit window or Mix window, double-click the Track Name button for a track. Then click directly in the Comments area, type any comments for the track, and press Enter (Windows) or Return (Macintosh).

 To enter a carriage return in the Comments text box, press Shift+Enter (Windows) or Shift+Return (Macintosh) on the alpha keyboard.

## Track Position Numbering

### (Pro Tools 6.4 Only)

Track Position Numbering assigns each track a number corresponding to its position in the Mix and Edit Windows. When tracks are reordered, they are renumbered to maintain positional sequence.

### To use track position numbering:

- Choose Display > Display Track Position Numbers

### To navigate directly to any track:

1 Choose Operations > Scroll To Track Number

– or –

Press Control+Alt+G (Windows) or Command+Option+G (Macintosh).

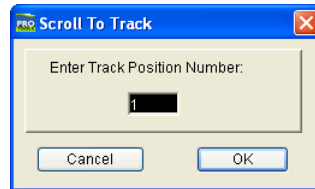

### Scroll To Track dialog

2 In the Scroll To Track dialog, enter the track position number.

3 Click OK.

The track is selected, and the windows scroll as follows:

- The Edit window tracks scroll to bring the selected track as close to the top as possible.
- The Mix window tracks scroll to bring the selected track as close to the left as possible.

## Deleting Tracks

When you delete tracks, your audio or MIDI region data will remain in the Regions List, but your arrangement of the regions on the deleted track (the track's playlist) will be lost.

**⚠** *The Delete Selected Tracks command cannot be undone.*

### To delete a track:

1 Click the name of the track in its track channel strip to select it.

 *To select multiple tracks, Shift-click additional track names.*

2 Choose File > Delete Selected Tracks.

3 Click OK to remove the selected tracks from the session.

## Duplicating Tracks

The Duplicate Selected Tracks command allows you to duplicate one or more tracks, including their audio or MIDI data, playlists, automation, and other attributes.

### To duplicate a track:

1 Click the name of the track (in its track channel strip) to select it.

 *To select multiple tracks, Shift-click additional track names.*

2 Choose File > Duplicate Selected Tracks. Each duplicate track is created to the right of its original track.

## Hiding Tracks

The Show/Hide Tracks List (at the left of both the Mix and Edit windows) lists all tracks in the session. It allows you to show or hide a track in the Mix and Edit windows, by selecting or deselecting its name. Even though a track is hidden, the material on the track will still play as part of the session. Inactive tracks appear in italics in the Show/Hide Tracks List.

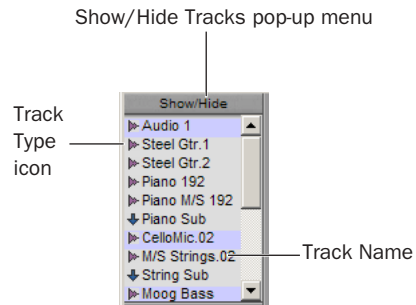

### Show/Hide Tracks List

The pop-up menu at the top of the Show/Hide Tracks List provides commands that allow you to show or hide all tracks, tracks currently selected on-screen, or specific types of tracks (audio, MIDI, Auxiliary Input or Master Fader).

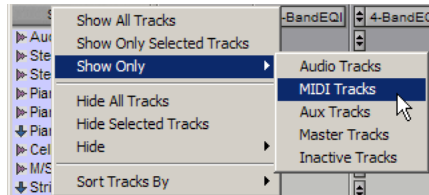

### Show Only option

The Sort Tracks By command allows you to set the track order according to Name, Type, Edit Group, Mix Group or Voice. The sort order will be reflected in the Show/Hide Tracks List in the Edit Window and the Mix Window.

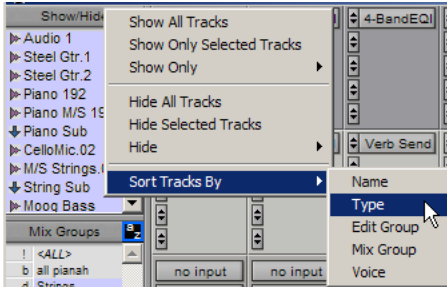

### Sort Tracks By option

When a track that is a member of an active group is hidden from view, editing operations performed on other members of the group in the Edit window will not affect the hidden track. In the Mix window, however, all operations other than record-enable will affect a hidden track that is a member of an active group.

**!** *On TDM systems, even if a track is hidden from view, its position relative to other tracks still affects its voiceable track playback priority (see “Voiceable Tracks and Track Priority” on page 98 for details).*

### To hide a track:

- Click the highlighted name of the track in the Show/Hide Tracks List.

### To show a track that is currently hidden:

- Click the unhighlighted name of the track in the Show/Hide Tracks List.

### To show all tracks:

- 1 Click the Show/Hide button at the top of the Show/Hide Tracks List.
- 2 From the pop-up menu, choose Show All Tracks.

 You can also show all tracks by Alt-clicking (Windows) or Option-clicking (Macintosh) the name of any track that is unhighlighted.

### To hide all tracks:

- 1 Click the Show/Hide button at the top of the Show/Hide Tracks List.
- 2 From the pop-up menu, choose Hide All Tracks.

 You can also hide all tracks by Alt-clicking (Windows) or Option-clicking (Macintosh) the name of any track that is highlighted.

 To reorder tracks on-screen, drag the track names to new positions within the Show/Hide Tracks List.

## About Groups and Show/Hide Tracks

Even if a track is hidden, if it is a member of an enabled group, all Mix window operations performed on other members of the group *will also affect the hidden track*—with the exception of audio or MIDI record-enabling. If you solo, mute, or automation write-enable a grouped track, any group members that are hidden will be soloed, muted, or automation write-enabled as well.

In the Edit window, however, editing operations performed on members of an enabled group will *not* affect hidden tracks that are also members of the enabled group.

## About Clipping and Show/Hide Tracks (HD-series Systems with Pro Tools 6.4 Only)

When a track, send, or plug-in clips, the Show/Hide List displays the track's name in red. Both shown and hidden tracks display clipping indication.

## About Track Numbering and Show/Hide Tracks

There are two ways to display track position numbers when tracks are hidden.

- By default, numbers are only assigned to tracks that are shown. Active tracks are then numbered sequentially. Hidden tracks are unnumbered.
- When Track Numbers Stay With Hidden Tracks is enabled in the Display Page of the Preferences, tracks keep their track position numbers even when hidden.

---

## Assigning Inputs and Outputs to Tracks

Inputs for audio tracks and Auxiliary Input tracks can be assigned to audio interface channels or busses. Outputs for audio tracks, Auxiliary Input tracks, and Master Fader tracks can be assigned to audio interface channels or busses.

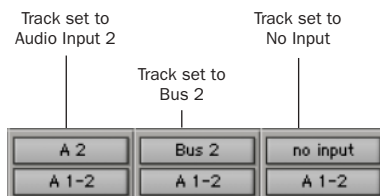

*Input/output assignments for three mono audio tracks*

For stereo and multichannel surround tracks, inputs and outputs appear as stereo pairs and multichannel groups. The available inputs, outputs, and busses are defined as *paths* in the I/O Setup dialog (see Chapter 7, “I/O Setup”).

## Automatic Input and Output Assignments

When adding tracks to a new session, inputs are automatically assigned in ascending order. For example, if you have an audio interface with eight inputs, creating four new mono audio tracks will automatically add four audio tracks with inputs assigned to the first four paths defined in the I/O Setup dialog. When creating stereo tracks, inputs are automatically assigned to ascending input pairs.

The outputs automatically assigned to new tracks are determined by the Default Output defined in the I/O Setup dialog.

## Assigning Audio Track Inputs (Audio and Auxiliary Input Tracks)

**To assign an audio track input:**

- 1 In order to assign audio track inputs in the Edit window, select Display > Edit Window Show > I/O View.
- 2 In the Mix or Edit window, click the track Input Selector and choose from the available audio interface channels and busses. Stereo and multichannel surround tracks have inputs available as pairs and multichannel groups.

The Input Selector allows you to route any audio input or any of the Pro Tools internal busses to an audio track or an Auxiliary Input track. The choices available in this pop-up menu are determined by the I/O Setup configuration. Inputs in use by another track appear as bold in the Input Selector.

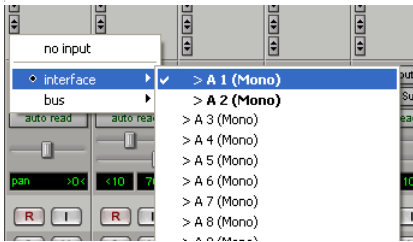

Audio track Input Selector

**To remove an input assignment:**

- Select No Input from the Input Selector.

## Assigning Audio Track Outputs

(Audio Tracks, Auxiliary Inputs, Master Faders)

**To assign an audio track output:**

- 1 In order to assign audio track outputs in the Edit window, select Display > Edit Window Show > I/O View.
- 2 In the Mix or Edit window, click the track Output Selector and choose from the available audio interface channels and busses. Stereo and multichannel surround tracks have outputs available as pairs and multichannel groups.

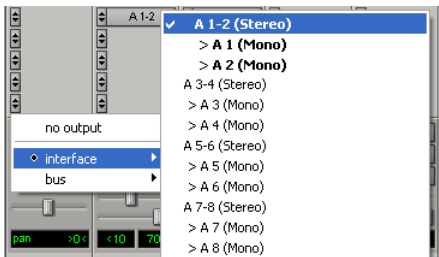

Audio track Output Selector

The Output Selector allows you to route a track to any configured audio output or internal bus. The choices available in this pop-up menu are determined by the I/O Setup configuration. Outputs in use by another track appear as bold in the Input Selector.

If you want to auto-assign all visible tracks to unique mono sub-path outputs in ascending order, Control-Alt-click (Windows) or Command-Option-click (Macintosh) the Output Selector of the left-most track and assign it to the sub-path for Output #1. All visible tracks will be auto-assigned to unique mono sub-path outputs in ascending order.

**To remove an output assignment:**

- Select No Output from the Output Selector. Playlists become dimmed for tracks with no output assignment.

**⚠** Assigning an audio track, Auxiliary Input, or Master Fader to “No Output” will cause its automation data for pan and plug-in controls to be lost.

## Track Priority and Voice Assignment

Pro Tools TDM systems provide a certain number of voices (simultaneous channels of audio playback and recording), depending on the system. For example, a Pro Tools|HD 1 system can provide up to 96 voices of audio playback and recording, at 44.1 or 48 kHz. For details on TDM system capabilities, see Table 3 on page 7.

Pro Tools LE systems provide up to 32 voices of simultaneous audio playback and recording, depending on the system. For details on LE system capabilities, see Table 5 on page 10.



## Track Priority

While your Pro Tools hardware allows a fixed number of voices, Pro Tools TDM software (and Pro Tools LE 6.x software) allow for additional audio tracks beyond that fixed number of voices. While all of these tracks can be recorded or imported, arranged, and cued for playback, not all of them can be played back simultaneously.

On TDM systems, you can also assign specific voices to tracks so that those voices are shared by more than one track. This combination of playback/record tracks and shared voiced tracks comprises the total number of *voiceable tracks* on a TDM system. See “Voiceable Tracks and Track Priority” on page 98.

When the number of tracks exceeds the number of available voices, tracks with lower priority may not be heard. For these situations, Pro Tools assigns priorities to tracks that compete for the available voices. Because there can be more tracks than available voices, Pro Tools provides multiple ways of adjusting the playback priority of audio tracks.

### Changing a Track's Playback Priority

Tracks with higher positions (leftmost in the Mix window or topmost in the Edit window) have priority over tracks in lower positions in a session.

#### To increase a track's priority, do any of the following:

- In the Edit window, drag the Track Name button above other tracks in the session. Tracks at the top of the Edit window have higher priority than those below.

- In the Mix window, drag the Track Name button to the left of other tracks in the session. Tracks at the left of the Mix window have higher priority than those on the right.

- In the Show/Hide Tracks List, drag the track name to a higher position in the list. Tracks at the top of this list have higher priority than those below.

You can also adjust the relative priority of tracks by freeing up the voices of individual tracks, making them available to other tracks in the session.

#### To free up the voice of a track, do one of the following:

- Click the Voice selector of the track and set it to Off.
- Deactivate the track by Control-Start-clicking (Windows) or Command-Control-clicking (Macintosh) its track type icon in the Mix window.
- Make sure the track does not have an output or send assignment.
- On TDM systems, you can temporarily free a track's voice during playback by muting it (see “Mute Frees Assigned Voice” on page 102).

## Voice Assignment

A track's voice assignment can be turned off or set to be dynamically allocated, and on TDM systems, can also be assigned to a specific voice number. When the tracks in a session are set to Dyn (called Auto in Pro Tools 6.3 and below), Pro Tools automatically takes care of voice management in the background, assigning voices not in use by other tracks.

On TDM systems, tracks assigned to a specific voice number take priority over dynamically allocated tracks. To ensure a track is heard, or that it is available for QuickPunch or TrackPunch recording, assign a voice number to that track.

**⚠** *Pro Tools LE 6.x supports auto voicing only; it does not support individual voice assignments.*

For stereo and multichannel tracks, voices appear in pairs and multichannel groups. Voices already assigned to another track appear in bold in the Voice Selector pop-up menu.

#### To set the voice assignment for a track:

- Click the Voice Selector and set the track to Dyn (*Auto* in Pro Tools 6.3 and below), Off, or (on TDM systems) select a voice number.

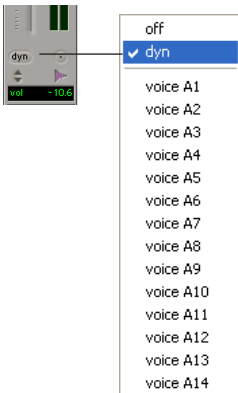

Voice Selector for stereo audio track (Pro Tools 6.4)

### Automatic Assignment of Ascending Voices

#### (TDM Systems Only)

You can automatically assign all tracks or all selected tracks to successive voices. For example, you may want to select eight audio tracks and reassign them to voices 9–16.

#### To assign all audio tracks to successive voices:

- While pressing Control+Alt (Windows) or Command+Option (Macintosh), select the starting voice number from the Voice Selector for the track at the top of the Edit window, or at the far left of the Mix window.

The voice is assigned to the first track, with successive voices assigned to tracks (with the same format) of lower priority.

#### To assign all selected audio tracks to successive voices:

- 1 Select the audio tracks by Shift-clicking their names.
- 2 While pressing Control+Alt+Shift (Windows) or Command+Option+Shift (Macintosh), select the starting voice number from the Voice Selector for the top (Edit window) or left (Mix window) selected track.

The voice is assigned to the starting track, with successive voices assigned to currently selected tracks (with the same format) of lower priority.

### Voiceable Tracks and Track Priority

#### (TDM Systems Only)

Pro Tools TDM systems feature *voice borrowing*, (called *dynamic voice allocation* in Pro Tools 6.3 and below) which allows you to assign more than one track to the same voice. The track with the highest priority takes over that voice, but when a hole opens up in the higher-priority track, its shared voice is temporarily available, and the track with the next highest priority “pops through” and begins to play. When the original track returns, the track that had popped through relinquishes the shared voice to the higher priority track.

The following example demonstrates the concept of voice borrowing:

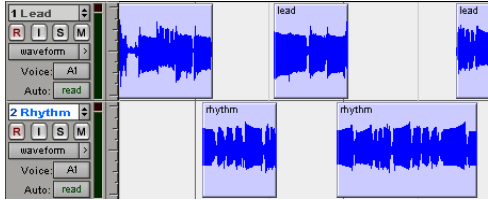

*“Rhythm” regions play when there is no “Lead” region*

In the above illustration, the two visible tracks are assigned to the same voice. There is an open area in the top track where no region appears. At this point, the voice is free since it is not being used, and the next highest priority track assigned to that voice (the bottom track) pops through the open area and plays.

By experimenting with track priority, voice assignment, and arranging regions so that they are positioned to “pop through” holes in higher priority tracks, you can find many useful ways to share voiceable tracks in your TDM system.

## Setting MIDI Input and Output

### Assigning MIDI Track Input

This MIDI Input Selector allows you to choose which MIDI device and channel a MIDI track is receiving input from. This allows you to set up Pro Tools to record multiple MIDI tracks in the same record pass. Channels in use by another track input appear as bold in the MIDI Input Selector.

**To assign a MIDI track input:**

- 1 In the Edit window, select Display > Edit Window Show > I/O View.
- 2 In the Mix window, click the track’s MIDI Input Selector and assign the device and channel that will be recorded.

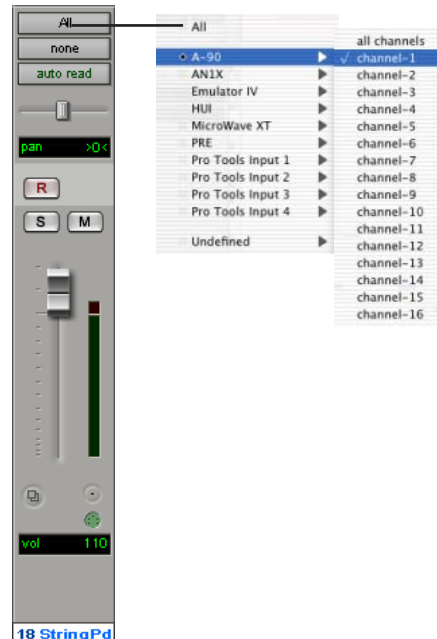

18 StringPd  
MIDI Input Selector

## Assigning MIDI Track Output

MIDI tracks can be assigned to one or more MIDI device channels with the Device/Channel Selector. When assigned to multiple channels, all material in the track is sent to all assigned channels.

MIDI tracks in Pro Tools cannot contain multiple channels of MIDI data.

### To assign a MIDI track (and all its regions) to a specific MIDI device channel:

- Click the track's MIDI Device/Channel Selector and assign a device and channel from the pop-up menu. Channels already assigned to another track appear bold in this menu.

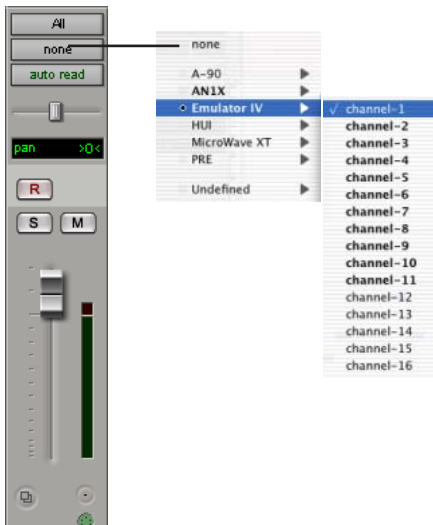

MIDI Device/Channel Selector

### To assign multiple destinations to a single MIDI track:

- Right-click (Windows) or Control-click (Macintosh) the MIDI Device/Channel Selector and select additional channels from any device.

For details on recording and importing MIDI data, see Chapter 13, “MIDI Recording.”

## Soloing and Muting Tracks

The Solo and Mute buttons can be engaged at any time during playback. The Solo and Mute buttons affect MIDI as well as audio tracks. It is possible to have more than one track soloed or muted at the same time in a session.

Grouping affects mute and solo behavior as well. Normally, muting or soloing a track that is a member of an active mix group will mute or solo all other tracks that are a member of that active mix group as well. However, by changing the Mute and Solo settings in the Pro Tools Preferences dialog, you can disable this behavior.

### To disable group muting of tracks:

- 1 Choose Setups > Preferences, and click Automation.
- 2 Deselect the Mutes Follow Groups option, and click Done.

With this option deselected, muting a track that is a member of an active group does not affect other members of the group.

 You can also mute or solo individual members of a group by holding down the Start key (Windows) or Control key (Macintosh) while selecting the track's Mute or Solo button.

### To disable group soloing of tracks:

- 1 Choose Setups > Preferences, and click Automation.
- 2 Deselect the Solos Follow Groups option, and click Done.

With this option deselected, soloing a track that is a member of an active group does not affect other members of the group.

## Solo Button

The Solo button mutes other tracks so that the chosen track can be auditioned alone. Normally solos are *latched*, that is, pressing subsequent solo buttons adds them to the soloed mix of tracks. Pro Tools lets you unlatch solos, so that pressing an additional Solo button un-solos any previously soloed tracks.

### To solo tracks:

- 1 Click the Solo button on a track. The button is highlighted and all other tracks are muted.
- 2 Click the Solo button on another track. The buttons for both tracks are highlighted and all other tracks are muted.

### To un-solo tracks:

- Click the Solo button on soloed tracks.

### To unlatch solo buttons:

- 1 Choose Setups > Preferences and click Operation.
- 2 Deselect the Latch Solo Buttons option and click Done. With this option disabled, pressing an additional Solo button un-solos any previously soloed tracks.

## Solo Safe Mode

Pro Tools also allows you to *solo safe* a track. This prevents the track from being muted even if you solo other tracks. This feature is useful for tracks such as Auxiliary Inputs that are being used as a submix of audio tracks, or effects returns, allowing the audio or effects track to remain in a mix even when other tracks are soloed. It is also useful to solo safe MIDI tracks so that their playback is not affected when you solo audio tracks.

### To solo safe a track:

- Control-click (Windows) or Command-click (Macintosh) the Solo button on the track. This prevents the track from being muted even if you solo other tracks. The Solo button changes to a transparent color in Solo Safe mode.

### To return a solo safe track to normal:

- Control-click (Windows) or Command-click (Macintosh) the Solo button on the track again.

## Mute Button

The Mute button silences a chosen track. More than one track can be muted at one time. If Operations > Mute Frees Assigned Voice (TDM systems only) is enabled, muting a track will allocate its voice to the next highest priority voiceable track (assigned to the same voice).

### To mute a track:

- Click the Mute button on the track. The track is grayed-out and muted.

### To unmute a track:

- Click the Mute button again.

## Mute Frees Assigned Voice

### (TDM Systems Only)

Selecting Operations > Mute Frees Assigned Voice and muting a track disables playback of that track, and surrenders control of its voice to the next highest priority track with the same voice assignment.

With this option enabled, there may be a delay (ranging in length from one to several seconds depending on the processing power of your system) between the time you mute or unmute a track and when you hear the effect on playback.

To avoid this delay, make sure that the Mute Frees Assigned Voice option is disabled. Another factor that can cause delays is your DAE Playback Buffer Size setting. Playback Buffer Size is set in the Playback Engine dialog. The larger the playback buffer you choose, the longer the potential lag time between the time you click the Mute button and the onset of muting.

**⚠** *Muting a track with Mute Frees Assigned Voice enabled does not free up the voice for QuickPunch recording.*

---

## Making Tracks Inactive

### (All TDM Systems and Pro Tools LE 6.x Only)

Audio, Auxiliary Input, and Master Fader tracks can be made inactive. Inactive tracks use no DSP or voices. Plug-ins, sends, voices, and automation on inactive tracks are all disabled. Tracks may also be automatically made inactive if a session is opened on a system with less DSP power than the system that it was created on.

**⚠** *MIDI tracks cannot be made inactive.*

### To toggle a track active/inactive:

- Control-Start-click (Windows) or Command-Control-click (Macintosh) the Track Type Indicator in the Mix window.

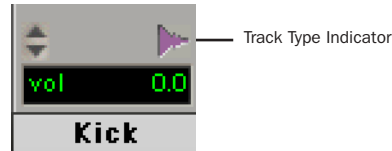

### Toggle a track active/inactive

Playlists for inactive tracks are dimmed and track controls are grayed out.

### To make one or more tracks inactive:

- 1 Click the name of the track (in its track channel strip) to select it.



*To select multiple tracks, Shift-click additional track names.*

- 2 Choose File > Make Selected Tracks Inactive.

---

## Adjusting Track Width

### Mix Window

The Narrow Mix Window command allows you to view all tracks/channels in the Mix window at a reduced width to conserve screen space in a large session. (See “Track Height” on page 210, to adjust track height in the Edit Window.)

### To reduce the width of tracks in the Mix window:

- Select Display > Narrow Mix Window.

### To display tracks at normal width:

- Deselect Display > Narrow Mix Window.



*You can toggle track width by pressing Control-Alt+M (Windows) or Command+Option+M (Macintosh).*

---

## Color Coding Tracks

The Display Preference for Edit Window Color Coding determines how colors are assigned to waveforms and MIDI data in the Edit window. Colors can be based on groups, voice assignment for audio tracks, and channels or devices for MIDI tracks.

Color coding of voices is especially useful when working with tracks assigned to the same voice. Since tracks assigned to the same voice share the same color, you can easily identify and arrange regions so that they do not overlap or conflict with other regions on tracks assigned to the same voice.

### To configure Edit Window Color Coding:

**1** Choose Setups > Preferences and click the Display tab.

**2** Select one of the following color coding options:

**None** Turns off color assignment for tracks in the Edit window.

**Tracks and MIDI Channels** Assigns a color to each track in the Edit window according to its voice and MIDI channel assignment.

**Tracks and MIDI Devices** Assigns a color to each track in the Edit window according to its voice and MIDI device assignment.

**Groups** Assigns a color to each track in the Edit window according to its group ID. If groups are suspended using the Suspend Groups command, all waveforms are displayed in black.

**3** Click Done to close the Preferences dialog.

---

## Grouping Tracks

Pro Tools provides a relative grouping function for linking tracks and their controls. Groups can be applied to either the Mix or Edit window, or both.

Groups are useful for editing several tracks in exactly the same way, or for mixing several tracks (such as a pair of stereo tracks or a submix) while keeping them at the same relative volume level.

Pro Tools provides the following grouping features:

- Up to 26 different groups
- Nested groups (subgroups within groups)
- Grouped faders or controllers preserve their levels relative to each other

Grouping can affect the following track parameters:

- Volume levels
- Solos
- Mutes
- Automation modes
- Send levels
- Send mutes
- Track view
- Track height
- Editing functions

Grouping does not affect these parameters:

- Record enables
- Panning
- Send panning
- Voice assignment
- Output assignment
- Inserting plug-ins

## Using the Groups List

The Pro Tools grouping functions are located at the left side of the Mix or Edit window in the Groups List. This scrolling window contains the names of all the groups in your session, as well as a pop-up menu for accessing grouping commands. From this menu, you can select and enable groups.

By default, every session has a group named *All*, which includes every track in the session. The *All* group cannot be edited or deleted.

To the left of each name in the Groups List is a letter denoting its Group ID (“a” through “z”), and to the left of that, a symbol indicating whether that group is selected in the current window (either the Edit or Mix window).

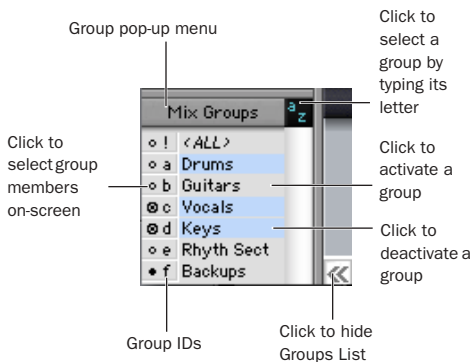

### Groups List

## Group Symbols

There are three types of Group symbols, as shown in the following figure:

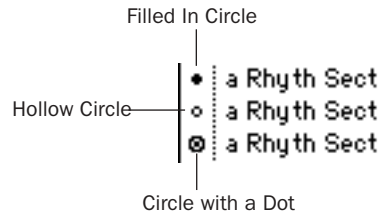

### Groups Symbols

The Group symbols indicate the following:

**Filled-in Circle** Indicates that all members of the group are currently selected, and no members from outside the group are selected.

**Hollow Circle** Indicates that only some members of the group are currently selected.

**Circle with a Dot** Indicates that all members of the group are currently selected, plus additional members *outside* the group.

## Show/Hide Groups Pop-up Menu

The Show/Hide Groups pop-up menu allows you to show or hide the tracks in a group, or show only the tracks in a group. Click and hold directly on the group name to display the pop-up menu, then select the Show/Hide option.

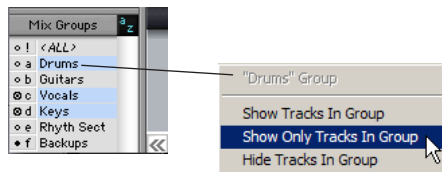

### Show/Hide Groups pop-up menu



## Groups Pop-up Menu

The Groups pop-up menu contains commands that allow you to create, delete and suspend groups, as follows:

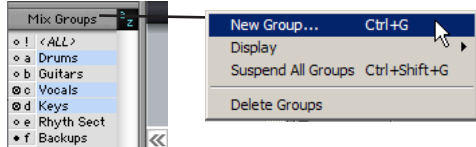

### Groups pop-up menu

**New Group** This command lets you create a new group. You must first select two or more tracks/channel strips on-screen to do this.

**Display** This command lets you toggle the Groups List display to either Mix Groups or Edit Groups. If all of your groups apply to both Editing and Mixing, the Groups List will be the same for both.

**Suspend All Groups** This command allows you to temporarily toggle all active groups off.

**Delete Group** This command lets you permanently remove a group from the Groups List. You must first select a Group Name in the Groups List to do this.

## Creating Groups

### To create a group:

1 Shift-click the Track Names for the tracks you want to include in the group to select them.

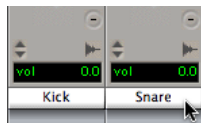

### Selecting tracks to be grouped

2 Choose New Group from the Group pop-up menu, or choose File > Group Selected Tracks.

3 Enter a name for the group.

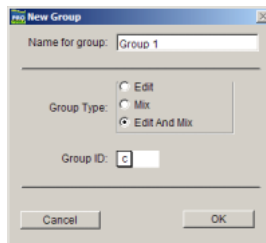

### New Group dialog

4 Choose the type of group to create: Edit Group, Mix Group, or Edit and Mix Group.

5 Choose a Group ID (“a”–“z”).

6 Click OK to add the new group to the Groups List.

## Editing Groups

### Changing the Members of a Group

You can add or remove members from a group at any time.

### To change the members of a group:

1 Shift-click the Track Names for the tracks you want to include in the group to select them.

2 Choose File > Group Selected Tracks from the Group pop-up menu.

3 In the dialog that appears, select the Group ID that you want to update.

4 Click OK.

## Renaming a Group

You can rename a group at any time.

### To rename a group:

- 1 In the Groups List, double-click to the left of the group's name (in the area with the circular symbols).
- 2 In the dialog that appears, enter a new name for the group. (You can also change the group's type.)
- 3 Click OK.

## Deleting a Group

A group can be deleted at any time. You cannot undo this action.

### To delete a group:

- 1 In the Groups List, select the name of the group (or groups) you want to delete.
- 2 Click the Group pop-up menu and choose Delete Group.

## Linking Mix and Edit Groupings

The “Link Mix and Edit Group Enables” option links group enabling between the Mix and Edit windows.

Pro Tools allows you to create groups that are *both* Mix and Edit groups, but in some cases you may prefer not to link enabling of Mix and Edit groups. For example, when you are using the Mix window for mixing, you may prefer to work with large, nested groups. However, in the Edit window, you may want to perform editing tasks within a smaller group. You could disable the Link Mix and Edit Group Enables preference. This would allow you to work with different groups in the two windows.

### To unlink Mix and Edit groups:

- 1 Choose Setups > Preferences and click Operation.
- 2 Deselect the “Link Mix and Edit Group Enables” option and click Done.

## Enabling Groups

Editing operations are not applied to members of a group that are hidden with the Show/Hide Tracks List. Mix operations (with the exception of record-enabling of tracks) are applied to hidden tracks.

Pro Tools allows you to create separate groups for editing and mixing. You set this option when you use the New Group command. Groups that apply to both editing and mixing can be decoupled.

### To enable a group:

- In the Groups List, click the name of the group you want to enable. The group name is highlighted to indicate that it is enabled.

To enable additional groups, click their names in the Groups List. It is not necessary to Shift-click to enable or disable multiple groups.

Moving a fader of a group member will cause all other group members to move relative to it. If a fader belongs to multiple groups, and the groups conflict when faders are moved, the fader will follow the topmost or “parent” group that it belongs to.

### To disable a group:

- In the Groups List, click the name of the group you want to disable. The group name is unhighlighted to indicate that it is not enabled.

## Keyboard Selection of Groups

The Groups List Key Focus allows you to type a Group ID letter to automatically toggle that group’s enable status.

- ◆ In the Mix window, the Groups List Key Focus is always enabled.
- ◆ In the Edit window, you need to enable the Groups List Key Focus to use it.

### To enable the Edit Groups List Key Focus:

- Click the a–z button in upper right of the Edit Groups List.
  - or –
- Press Control+Alt+4 (Windows) or Command+Option+4 (Macintosh).



### Groups List Key Focus enabled

### To enable and disable groups using the Edit and Mix Groups List Key Focus:

- With Group List Key Focus enabled, type the Group ID letter (a–z) to automatically enable or disable the corresponding group.



# Chapter 9: Importing and Exporting Session Data

Pro Tools allows you to import a variety of data into a session, including audio and MIDI files, video files, track playlists, I/O configurations, and signal routing configurations.

You can import audio and MIDI files into a session, or transfer entire audio or MIDI tracks, along with all of their attributes, from another session. Additionally, on TDM systems, you also have the option of importing any combination of track attributes from another session, such as a track's audio or MIDI playlists, signal routing, plug-ins, or automation. See “Importing Audio” on page 109 and “Importing Tracks and Track Attributes” on page 114.

---

## Importing Audio

Audio files and regions can be imported to new tracks, or they can be imported into the Audio Regions List, where they can be dragged to existing tracks.

Files of types that are not supported in the session must be converted when importing. Files with sample rates that are different from the sample rate of the current session must be converted in order for the files to play back at the correct pitch and speed.

Audio files of the following types can be imported into Pro Tools sessions:

- AIFF
- WAV or BWF (.WAV)
- SD II
- SD I
- MP3 (with purchase of MP3 Option)
- Sound Resource (AIFL—Macintosh only)
- WMA (Windows Media—Windows only)
- QuickTime (Macintosh only)
- RealAudio (Pro Tools 6.1 and lower on Windows, and Pro Tools 5.x on Macintosh)

Supported files and regions can be auditioned before they are imported.

If region definitions are present in an audio file, you can convert and import the audio for a region without importing the entire parent audio file.

## Copying, Adding, and Converting Audio

Depending on the properties of the audio files you are importing, you can add, copy, or convert the files. The following options appear in the Import Audio dialog when they are applicable to the selected audio file.

### Add

Audio files that are of the same file type and bit depth as a session can be added directly to the session. When you add an audio file, the session references the original audio file in its original location. Use this option when you don't want to use extra hard drive space for audio files that are already of the same bit depth and sample rate as your session.

Pro Tools does allow audio files that are not the session's native file type to be added to the session. For example, Windows sessions allow AIFF or WAV files to be added to any session, and Macintosh sessions allow SDII, AIFF, or WAV files to be added to any session. However, sessions with mixed file types will have reduced performance.

Audio files that are of a different bit depth than the session must be converted before they can be imported.

 *Pro Tools allows you to add files to a session that are at a different sample rate than your session. In the comments field of the Import Audio dialog, a warning is posted that these files will play back at the wrong speed and pitch if they are not converted.*

### Copy

If a file can be added to your session, you will also be given the option to copy it. This option creates a copy of the audio file and places it in a folder you choose. When you copy an audio file, the session references the copied file in its new location.

Use Copy to move audio from an unsupported or removable drive to an audio drive, or to archive audio files for a session to a specific location.

### Convert

Audio files that are not of the same bit depth or sample rate as a session, or audio files that are of an incompatible file type (such as SD II files in Windows) must be converted to be used with the session. When an audio file is converted, a new file with the correct bit depth, file type, and sample rate is created and placed in a folder you choose.

The quality of sample rate conversion used by Pro Tools is determined by the Preference for Conversion Quality. For details, see "Conversion Quality" on page 111.

## Importing Stereo Files

When using the Import Audio to Tracks command, interleaved stereo files are automatically imported to stereo tracks.

Split stereo (dual mono) audio files can be automatically imported to stereo tracks. Split stereo audio files must have the channel identifiers ".L" and ".R" in their names (for example, *filename.L* and *filename.R*), and the files must be the same length. In Windows, or in Mac/PC Compatibility mode, these files will have a 3-letter file extension appended after the ".L" or ".R" channel identifier.

---

## Conversion Quality

The Conversion Quality Preference determines the quality of sample rate conversion used when converting and importing audio into a session. There are five possible settings, ranging from *Low* to *Tweak Head*. The higher the quality, and the larger the conversion, the longer it will take.

### To set the sample rate conversion quality:

- 1 Choose Setups > Preferences, and click Editing.
- 2 From the Conversion Quality pop-up menu, select a quality setting.

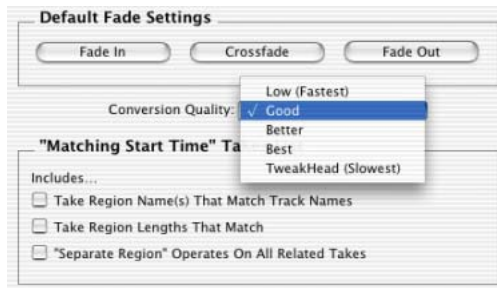

### Conversion Quality preference

For most applications, the Good or Better setting will yield very good results.

- 3 Click Done.

---

## Importing Audio Files and Regions

Pro Tools provides several ways to import audio files and regions into an open session. This section provides steps using Pro Tools menu commands, or the Pro Tools icon or alias.

For additional ways to import audio files, see “Importing Audio Files with Drag & Drop from a DigiBase Browser” on page 113. To import audio from CDs (Macintosh only), see “Importing Audio from an Audio CD” on page 114.

### To import audio files or regions into a session (from the Pro Tools File menu):

- 1 Choose File > Import Audio to Track to import audio files and automatically place them in new tracks.

– OR –

Choose Import Audio from the Audio Regions List pop-up menu to import audio into the Audio Regions List without automatically creating new tracks.

To import entire tracks from other sessions, see “Imports any Pro Tools mic preamplifier settings from the source session. Any mic preamplifier settings in the destination session are replaced.” on page 121.

**2** At the top of the Import Audio dialog, select an audio file to display its properties and associated regions.

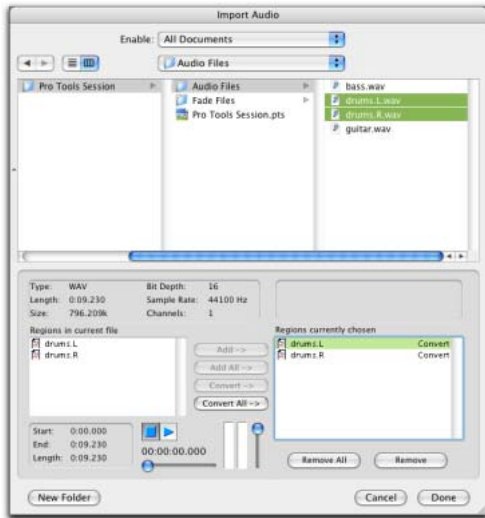

**Figure 6.** Import Audio dialog (Pro Tools 6.4)

You can choose to display only a certain file type (such as AIFF) by selecting the type from the Show pop-up menu. To display all supported file types, select All Documents from the Show pop-up menu.

**⚠** On the Macintosh, Sound Resource files must have the “.SFIL” extension to be imported by Pro Tools.

**3** To audition a selected file or region before you import it, click the Play and Stop buttons.

Adjust playback volume with the vertical slider. To navigate to a particular location in the file, use the horizontal slider under the Play and Stop buttons.

The audition output defaults to channels 1–2. On TDM systems, the audition output channels can be changed in I/O Setup or Hardware Setup.

**4** To place a file or region in the import list (on the right in Windows, or in the lower right of the dialog on a Macintosh), select the file (Shift-click to select multiple files) and click Add or Convert. You can also click Add All or Convert All to import all regions and files in the current directory.

In the import list, audio files are distinguished from regions by their icons.



Audio File icon



Audio Region icon

#### File and Region icons in the Import Audio dialog

**5** To remove a file or region from the import list on the right, select it and click Remove. To remove all regions or files, click Remove All.

**6** Once the audio files and regions have been added to the import list, click Done.

**7** If you are copying or converting files, you are prompted to choose a location for the new audio files. Choose a folder on a valid audio drive, such as the Audio Files folder for your current session.

If you chose File > Import Audio to Track, the files and regions are imported to new audio tracks, and also appear as regions in the Audio Regions List.

If you chose Import Audio from the Audio Regions List, the files and regions appear as regions in the Audio Regions List.



**To import audio files into a session, using the Pro Tools application icon or alias:**

- 1 Open or create a new session.
- 2 From the desktop, locate the audio files you want to import. Make sure the files match the session's file type, bit depth, and sample rate.

Audio files must be in WAV, SDII, or AIFF/AIFC format in order to be dropped into Pro Tools.

Audio files will be converted if they are not of the correct bit depth or number of channels. They will be converted to mono files of the default audio file format, with the session's bit depth and sample rate.

- 3 Drag the audio files onto the Pro Tools application icon or alias.

---

## **Importing Audio Files with Drag & Drop from a DigiBase Browser**

You can import audio by dragging it directly from a DigiBase browser into the Edit window of the current session.

### **To import audio into the Audio Regions List:**

- 1 Select audio files in a DigiBase browser.
- 2 Drag the files onto the Audio Regions List of the current session.

### **To import audio into an existing track:**

- 1 Select audio files in a DigiBase browser.
- 2 Drag the files onto an existing track in the Edit window of the current session.

### **To import audio into new tracks:**

- 1 Select audio files in a DigiBase browser.
- 2 Shift-drag the files and drag them anywhere in the Edit window of the current session.

– or –

Drag the files onto any empty space in the Edit window of the current session.

 *For more information on using DigiBase browsers, refer to the DigiBase Guide.*

---

## Importing Audio from an Audio CD

### (Macintosh Only)

Pro Tools lets you import tracks from an audio CD using the DigiBase drag and drop feature or the Import Audio From Other Movie command. Since the transfer is made in the digital domain, there is no signal loss.

The sample rate for audio CDs is 44.1 kHz. Therefore, if your session's sample rate is set to 48 kHz or higher, Pro Tools will convert the sample rate for the imported audio. Before importing CD audio, set the Conversion Quality Preference accordingly. See "Conversion Quality" on page 111 for details.

Before importing CD audio, make sure your hard drive has enough space for both the imported movie file *and* the converted audio files.

### To import a CD audio track:

- 1 Insert the audio CD into your CD-ROM drive.
- 2 Select the audio track in a DigiBase browser.
- 3 Drag the file onto the Audio Regions List of the current session.

Pro Tools converts the CD audio track to the session's audio file format, bit depth, and sample rate, and saves it on your hard drive.

The imported audio file appears in the Audio Regions List. From there you can drag the region to a track in your session.

 *DigiBase offers additional ways to import audio from CDs with drag and drop. See "Importing Audio Files with Drag & Drop from a DigiBase Browser" on page 113.*

---

## Importing Tracks and Track Attributes

You can import entire tracks from other Pro Tools sessions into the current Pro Tools session using the Import Session Data command. On TDM systems, you can choose which attributes of those tracks you want to import.

For example, on TDM systems, you can choose to import only the track's audio into your current Pro Tools mixer. This is analogous to "changing the tape reel" in a traditional studio setup with a tape machine and mixing console. Or, you can choose to import all of a track's mixer settings without its audio, effectively importing a channel strip and using it on a track in your current session. By importing mixer settings for all of the tracks in a session or session template, you can reuse an entire Pro Tools mixer on all the sessions in a project.

### To import tracks or their attributes:

- 1 Open or create a new session.
- 2 Choose File > Import Session Data, select the session to import data from, and click Open.

– or –

Drag the session file whose tracks or attributes you want to import from a DigiBase browser into the track playlist area in the current session's Edit window.

 *For details on using DigiBase to import tracks, refer to the DigiBase Guide.*

- 3 If the Fader Gain of the sessions are different, you will be prompted to keep or change Fader Gain before the Session Data dialog opens.

**4** Select the tracks to import by clicking the track names in the Source Tracks list. (If the current Pro Tools system does not support surround mixing, surround tracks are not displayed in the Source Tracks list.) To select multiple contiguous tracks, Shift-click the track names. To select multiple non-contiguous tracks, Control-click (Windows) or Command-click (Macintosh) the track names.

**5** On TDM systems, for each track you select, you can choose to import it as a new track, or choose a destination track from the corresponding pop-up menu. Click Find Matching Tracks to automatically match source and destination tracks with the same names.

**6** On TDM systems, select from among the Track Playlist options to choose how you want to import the source tracks.

**7** If applicable, choose options for how media files should be imported from the Audio Media Options and the Video Media Options pop-up menus.

**8** Choose the Time Code Mapping option for imported data.

**9** If the sample rates of the sessions are different, select the sample rate for the source session from the Source Sample Rate pop-up menu.

**10** To import the meter and tempo maps from the source session, select the Import Tempo/Meter Map option.

**11** On TDM systems, to import any mic pre settings from the source session, select the Import Mic Pre Settings option.

**12** Click OK when you are finished.

**13** If you chose to copy or consolidate media, choose a location to place the media files.

**⚠** *Imported tracks are made inactive if their source media is unavailable, or if the current session does not contain an equivalent output path.*

## **Importing Grouped Playlists from Other Sessions**

With Pro Tools 6.1 and higher, you can import tracks that use Grouped Playlists from another Pro Tools session, and the playlist grouping function will remain intact for those imported tracks. There is, however, a restriction for importing from pre-Pro Tools 6.1 sessions. After importing a partial set of grouped playlists (such as tracks 1–7 of a 10-track group), you cannot subsequently import tracks 8–10 and have them “rejoin” the playlist group for tracks 1–7.

However, it is possible to perform this function when importing from sessions created in Pro Tools 6.1.

## Import Session Data Dialog

The Import Session Data dialog lets you view the properties of the source session, select which tracks to import, and on TDM systems, choose which attributes of those tracks you want to import into the current session.



Import Session Data dialog (Pro Tools TDM 6.x)

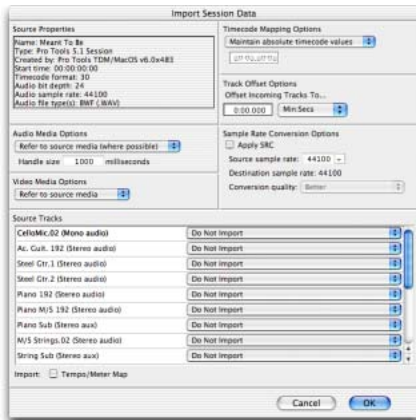

Import Session Data dialog (Pro Tools LE 6.x)

## Source Properties

The Import Session data dialog displays properties for the source session. These properties include source session name, session type, start time of the session, audio bit depth, and sample rate. For Pro Tools 5.1 or higher sessions, the program that created the session and the session's audio file type are listed.

## Audio Media Options

**Refer to Source Media (Where Possible)** This option lets you avoid duplicating audio files by referring to the original files when possible. If the source files do not reside on supported playback media (such as a CD-ROM), or if they require bit depth or sample rate conversion, the source files are copied instead. This option allows the current session to refer to files that do not match the current session's audio file format.

**Copy from Source Media** This option copies all audio files related to the imported tracks from the source media to a new specified location, and converts the files to the current session's audio file format, bit depth, and sample rate if necessary. This is useful if you are importing tracks from a source such as CD-ROM or shared storage, and you want to place the audio files on a different hard drive.

**Consolidate from Source Media** This option consolidates audio while copying it. This is useful if you want to copy only the regions of the audio files used in the source tracks, without copying unused audio. This option copies and converts consolidated audio to the current session's audio file format, bit depth, and sample rate if necessary.

When you choose this option, you can also choose the size of the handle (in milliseconds) applied to consolidated audio. *Handle* is the amount of the original audio file that is preserved before and after each region in case you need to make any edits to the new regions.

### **Force to Target Session Format (Convert Audio Media to New Session Format in Pro Tools 6.0)**

This option copies and converts any files that do not match the current session's file format, bit depth, and sample rate. Files that do match the current session's file type, bit depth and sample rate are referred to directly and not copied.

### **Video Media Options**

You can either choose to leave video media files in their original locations or copy them to a new location. This is useful if you are importing tracks from a source such as CD-ROM or shared storage, and you want to place video files on a different drive.

### **Time Code Mapping Options**

You can specify where the imported tracks are placed in the current session. Times are indicated in time code for all TDM systems and Pro Tools LE systems with DV Toolkit, and minutes:seconds for other Pro Tools LE systems.

**Maintain Absolute Time Code Values** This option places tracks at the locations where they were located in the source session. For example, if the current session starts at 00:01:00:00, and the session from which you are importing starts at 10:00:00:00, the earliest imported tracks can appear in your session is 9 hours and 59 minutes after the start of the session.

**Maintain Relative Time Code Values** This option places tracks at the same offset from session start as they had in the source session. For example, if the source session starts at 01:00:00:00 and contains a track that starts at 01:01:00:00, and the current session start is 02:00:00:00, the track will be placed at 02:01:00:00 in the current session.

**Map Start Time Code to hh:mm:ss:ff (All TDM Systems and Pro Tools LE Systems with DV Toolkit) or hh:mm:ss (Pro Tools LE Systems without DV Toolkit)** This option places tracks relative to their original session start time. For example, on a TDM system, or Pro Tools LE system with DV Toolkit, if the current session starts at 00:01:00:00, and the session from which you are importing starts at 10:00:00:00, you can reset the start time code to 00:01:00:00, to avoid placing files 9 hours and 59 minutes from the start of your session.

### **Track Offset Options**

You can specify a track offset in addition to any offset incurred with the Time Code Mapping options. Any imported audio is offset in the current session's timeline by the specified amount. You can enter values in Minutes:Seconds, Bars|Beats, Samples, Time Code, or Feet/Frames.

### **Sample Rate Conversion (SRC) Options**

You can set options that control how sample rate conversion is applied to imported audio files. If the source session and the current session have the same sample rate, this portion of the dialog is unavailable.

**Source Sample Rate** For audio files created in any session, no matter what the session sample rate is, you can have the sample rate conversion process treat the files in several ways to compen-

sate for pull-up, pull-down, and NTSC or PAL frame rates. This setting allows you to choose the sample rate from which you want the sample rate conversion process to start.

**Destination Sample Rate** The destination sample rate is always set to the sample rate of your current session.

**Conversion Quality** This option lets you set the quality of the sample-rate conversion process. See “Conversion Quality” on page 111.

## Source Tracks

This area of the dialog lists the tracks in the source session that can be imported, each with a corresponding pop-up menu.

## Operation/Destination Track Pop-Up Menus

For each source track, there is a corresponding pop-up menu that lists options for importing the track and, on TDM systems, possible destination tracks in the current session. The pop-up menus display the following items:

**Do Not Import** Neither the source track nor any of its attributes are imported.

**Import as New Track** The source track and all attributes selected in the Session Data to Import menu are imported into a new track in the current session.

**(Destination Track Names)** On TDM systems, the names of possible destination tracks in the current session are listed at the bottom of the pop-up menu. Imported playlists and all attributes selected in the Session Data to Import will be placed in the destination track you choose.

Only destination tracks that match the track type (audio, MIDI, Auxiliary Input, or Master Fader) and the channel format (mono, stereo, or any of the supported multichannel formats) of the source track appear in the pop-up menu.

## Find Matching Tracks

### (TDM Systems Only)

If you are importing playlists from source tracks with the same name as destination tracks in the current session, click Find Matching Tracks to automatically match the track names. Tracks must have the same name, track type, and channel format to be automatically matched.

## Session Data to Import

### (TDM Systems Only)

The Session Data to Import menu is where you select which attributes of the selected tracks you want to import into the current session.



### Session Data options in the Import Session Data dialog

The selected attributes are applied to all tracks that you choose to import into the current session.

## Replacing Track Attributes

When you import an attribute of the source track into an existing track in the current session, it replaces the corresponding attribute in the destination track. If you choose not to import an attribute of the source track, the corresponding attribute in the destination track is retained.

## Replacing Track Path Names

When you import a track's input, output, send output or hardware insert assignments, any custom path names and I/O configurations from the source session are not imported. You can import path names and I/O configurations by importing I/O Setup settings. See "I/O Settings Files" on page 80 for more information.

## Selecting Track Attributes to Import

You can select All, None, or any combination of the listed attributes to import. The following attributes are available to import:

**All** Imports all of the source track's playlists, according to the Track Playlist Option setting, and all of the attributes in the Session Data to Import list.

**None** Imports only the source track's main playlist, according to the Track Playlist Option setting, and no other attributes of the source track.

**Alternate Playlists** Imports all of the source track's alternate playlists. The alternate playlists appear in the destination track's playlist pop-up menu.

**Regions and Media** Imports all of the audio files or regions in the source track, and places them in the Audio Regions List.

**Volume Automation and Setting** Imports the source track's Volume Fader setting and any automation data on the track's Volume Automation playlist. The Volume Fader setting and any Volume automation data in the destination track are replaced.

**Pan Automation and Setting** Imports the source track's Pan Slider settings and any automation data on the track's Pan Automation playlist. The Pan Slider setting and any Pan automation data in the destination track are replaced.

**Mute Automation and Setting** Imports the source track's Mute setting and any automation data on the track's Mute Automation playlist. The Mute setting and any Mute automation data in the destination track are replaced.

**Main Output Assignments** Imports the source track's channel output assignments, including any multiple output assignments. The channel output assignments in the destination track are replaced.

**Send Output Assignments** Imports the source track's send output assignments. Any Send output assignments in the destination track are replaced.

**Plug-In Assignments** Imports the source track's plug-in assignments. Any plug-ins in the destination track are removed, and their associated settings and automation are lost.

If the source track uses a plug-in that is not available on the destination system, it appears in the destination track and is made inactive.

**Plug-In Settings and Automation** When the source track's plug-in assignments are imported, this option imports the track's plug-in settings and any automation data associated with the plug-ins. If no plug-in assignments are imported, this option has no effect.

**Hardware Insert Assignments** Imports the source track's hardware Insert assignments. Any Insert assignments in the destination track are replaced.

**Voice Assignments** Imports the source track's voice assignment from the source session. Any voice assignments in the destination track is replaced.

**Input Assignments** Imports the source track's channel input assignment. The Input assignment in the destination track is replaced.

**Sidechain Assignments** When the source track's plug-in assignments are imported, this option imports any side-chain assignments associated with the plug-ins. If no plug-in assignments are imported, this option has no effect.

**I/O Labels (Path Names)** Imports the source track's path names.

**Track Active State** Imports the active/inactive state of the source track from the source session.

**Track Comments** Imports the track comments associated with the source track. Any comments in the destination track are replaced.

**Record Safe/Solo Safe Settings** Imports the record safe and solo safe settings of the source track from the source session. Any record safe or solo safe settings in the destination track are replaced.

**Track View Settings** Imports the track height and playlist view of the source track from the source session.

## Track Playlist Options

### (TDM Systems Only)

You can select from the following options to control how the main playlist from each source track is imported to the destination track in the current session.

#### Import Main Playlists — Replacing destination main playlists

Imports the main playlist from the source track. When you import the playlist into an existing track, the main playlist in the destination track is deleted and replaced with the imported playlist.

- ◆ If you select the above option and import all of the source track's attributes, this is equivalent to importing the entire track.
- ◆ If you select the above option and do not import any of the source track's attributes, you replace the audio playlists while keeping your current mixer settings.

#### Import Main Playlists — Overlaying new with existing, trimming existing regions

Imports the main playlist from the source track. When you import the playlist into an existing track, any existing playlist data that overlaps data imported from the source track is trimmed and replaced with the imported data. Any playlist data in the destination track that does not overlap remains in the destination track.



## Do Not Import Main Playlists — Leaving destination playlists intact

Does not import the main playlist from the source track. No audio is imported; only the attributes selected in the Session Data to Import list are imported to the selected tracks.

◆ If you select the above option and import all of the source track's input, output, send, insert and plug-in attributes, this is equivalent to importing a channel strip.

## Import Tempo/Meter Map

Imports the meter and tempo maps, as they appear in the Tempo and Meter Conductor rulers, from the source session. Any Tempo or Meter events in the destination session are replaced.

## Import Pre Settings

### (TDM Systems Only)

Imports any Pro Tools mic preamplifier settings from the source session. Any mic preamplifier settings in the destination session are replaced.

---

## Exporting Audio

Pro Tools supports exporting regions as audio files, exporting left and right audio files as stereo interleaved files, and exporting region information.

You can also export audio from Pro Tools by bouncing or consolidating audio tracks. For more information, see “Bounce to Disk” on page 482.

## Exporting a Region as a New Audio File

You can export regions as audio files with the Export Selected As Files command. Use this command if you intend to use a region in other sessions (or other audio applications) without using its parent source file.

This command also provides a way to convert regions to a different audio format, sample rate, or bit depth.

### To export regions as new audio files:

- 1 In the Audio Regions List, select the regions you want to export.
- 2 From the Audio Regions List pop-up menu, choose Export Selected As Files. The Export Selected dialog appears.

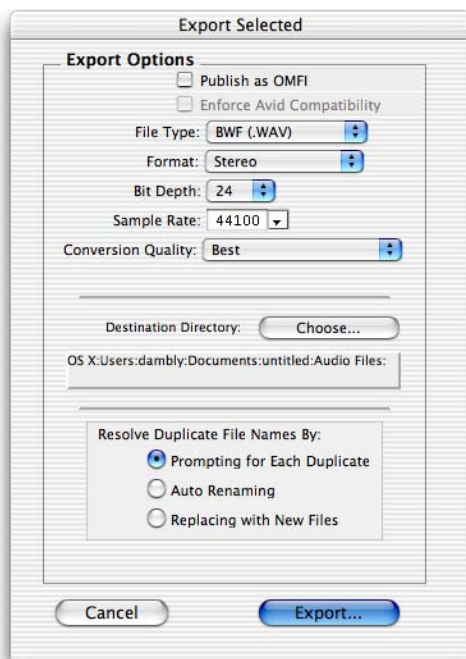

Export Selected dialog

3 In the Export Selected dialog, set the file type, format, bit resolution, and sample rate. In addition, specify the Conversion Quality, and choose the destination directory.

4 Select an option for how Pro Tools should resolve duplicate file names.

**Prompting for Each Duplicate** prompts you for a file name for any file that has the same name as a file in your destination directory.

**Auto Renaming** automatically changes the name of any duplicate file by adding a number at the end of the file name (such as file\_01).

**Replacing with New Files** replaces files with the same name with the new files.

5 Once the Export Options are configured, click Export to export the new audio files.

 *When you Export Selected with a lower bit rate, Dither (and Noise Shaping) may be applied. See the following table:*

**Dither and Noise Shaping with Export Selected**

Bit Rate	Dither	Noise Shaping
24-bit to 24-bit	No	No
16-bit to 24-bit	No	No
24-bit to 16-bit	Yes	Yes
16-bit to 16-bit	No	No
24-bit to 8-bit	Yes	No
16-bit to 8-bit	Yes	No

For more information about using Dither, see “Dither” on page 430.

## Exporting Stereo Interleaved Files

You can use the Export Selected As Files command to export audio regions to stereo interleaved files for use in other applications. (Pro Tools sessions do not support stereo interleaved files.) For this to work, the selected regions must have identical names with “.L” and “.R” suffixes (for instance, vocals\_01.L and vocals\_01.R). These regions appear as a stereo region in the Audio Regions List.

### To export regions as a stereo interleaved file:

1 Select the stereo audio region in the Audio Regions List or in the track playlist. If the regions appear on mono tracks in the session, select the two mono regions.

2 From the Audio Regions List pop-up menu, choose Export Selected As Files.

3 In the Export Selected dialog, select “Interleaved” in the Format pop-up menu.

4 Configure any other output settings, then click Export to export the new stereo interleaved file.

## Exporting Region Definitions

Pro Tools stores region definitions for audio files within each session. If you want to use an audio file’s regions in another session, or with another application that supports them, you can export the region information.

The Export Region Definitions command does not export regions as audio files (unlike the Export Selected As Files command). Instead, it stores pointers to the regions within the parent source file.

### To export region definitions for an audio file:

- 1 In the Audio Regions List, select any regions for which you want to export definitions. You do not have to select the parent file audio region.
- 2 Choose Export Region Definitions from the Audio Regions List pop-up menu.
- 3 Click Export.

---

## Exporting Pro Tools Tracks as OMFI or AAF Files

With the DigiTranslator Integrated Option, Pro Tools lets you export individual tracks or an entire Pro Tools session in OMFI format (Pro Tools 5.1.3 and higher) or AAF format (Pro Tools 6.1 and higher). This option requires DigiTranslator 2.0 or higher.

 *Pro Tools with DigiTranslator does not support AAF files with embedded media.*

 *For more information on installing and using DigiTranslator with Pro Tools, refer to the DigiTranslator Guide.*

---

## Exporting Sessions as Text

### TDM Systems Only

You can use the Export Session As Text command to create a text file that contains extensive information about your session.

This text file can contain a list of audio files, audio regions, audio track EDL (edit decision list) information, extended timestamp information, and information about crossfades.

Track EDLs are exported as tab-delimited text—that is, with tabs between each column heading, and tabs between each event parameter. You can use this data in a program for reading EDLs, or you can format the EDL data into tables using a word processor or spreadsheet application.

### Export Session as Text Options

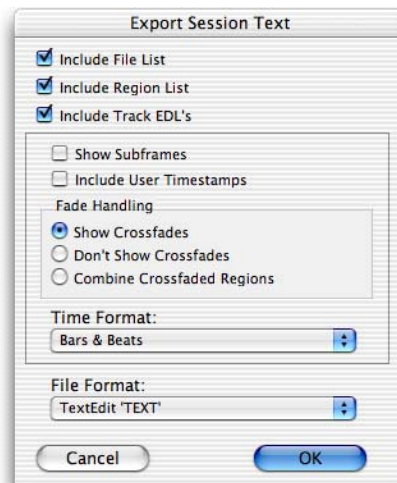

*Export Session Text dialog*

## Include File List/Region List

You can choose to export a list of the session's audio files and regions. The File List provides a list of all the audio files and fades in the session, and their hard drive locations. The Region List displays all audio regions in the session, and the source audio file for each region.

## Include Track EDLs (Playlists)

You can export track EDLs (playlists). Track EDLs can be used to spot-check region placement and edits, or in a conforming program for post applications. In extreme circumstances the EDL can be used to recreate the entire session.

 *MIDI track EDLs are not exported.*

When exporting track EDLs, the following options are available:

**Show Subframes** This option allows you to export subframe time information with track EDLs, if used in your session.

**Include User Timestamps** You can include user timestamps with track EDLs. User timestamps indicate a user-defined session location for the region, or the original location of the region when recorded.

**Fade Handling** For track EDLs, you can choose whether to show crossfades, not to show them, or to combine crossfaded regions. When regions are combined, their durations and locations are listed up to the center of the crossfade (for the leading region) and from the center of the crossfade (for the following region).

**Time Format** You can select the appropriate time format that exported EDL information is based on. For example, for post work, you might select SMPTE time, but for music creation locked to a grid, you might select Bars & Beats.

## File Format

You can choose to export to any of several different text formats. These include standard text formats, and Microsoft Word and Excel formats.

## The Exported Session Text

### Session Information

The session text file starts with basic information about the session. This information includes the session name, sample rate, bit depth, time code format, and number of audio tracks, audio regions, and audio files, as shown in the following example.

#### Session Information

SESSION NAME:	Ripleys II-092700
SAMPLE RATE:	48000.000000
BIT DEPTH:	24-bit
TIME CODE FORMAT:	30 Frame
# OF AUDIO TRACKS:	19
# OF AUDIO REGIONS:	203
# OF AUDIO FILES:	54

### File List and Region List

Next, if you choose to include them, are the lists of audio files and regions.

### Track EDLs

The final item, if exported, is the list of track EDLs. A track EDL lists the track name, and all edits, including the event number, the region name, region start and end time, and region duration. The region timestamp is also exported, if you select this option. Subframes are shown in each time field if you select this option.

### To export a session as text:

- 1 Choose File > Export Session As Text.
- 2 Select whether to include the File List, Region List, and track EDLs.
- 3 If you choose to include track EDLs, select whether to show subframes, and whether to include user timestamps. Also select an option for crossfade handling.
- 4 If you choose to include track EDLs, select the Time Format for the exported session text from the pop-up menu.
- 5 Select the File Format for exported text using the pop-up menu.
- 6 When you have set your options, click OK.
- 7 Select a location and enter a filename for the exported text file. In Windows, Pro Tools adds the correct 3-letter filename extension, while on the Macintosh, the file extension “.txt” is added.

---

## Importing MIDI Files

You can import Standard MIDI Files into your Pro Tools sessions. Use the Import MIDI to Track command to place the imported MIDI onto new tracks; or use the Import MIDI command in the MIDI Regions List pop-up menu to place the data in the MIDI Regions List, where it can be dragged to existing tracks.

Pro Tools does not import proprietary sequence files. To use sequences from other MIDI applications in a Pro Tools session, you'll need to first save them as Standard MIDI Files. Refer to the manufacturer's documentation for details on saving Standard MIDI Files.

There are two types of Standard MIDI Files, both of which are supported by Pro Tools:

- ◆ Type 0 MIDI files store data for all MIDI channels in a single track. When importing these files, Pro Tools separates the data by channel and places each track's data in separate regions and tracks.
- ◆ Type 1 MIDI files, sometimes referred to as multitrack MIDI files, contain multiple tracks of MIDI data. When importing these files, each track's data is placed on its own new MIDI track in the Pro Tools session.

### To import a Standard MIDI File to new tracks:

- 1 Choose File > Import MIDI to Track.
- 2 Select the MIDI file you want to import.

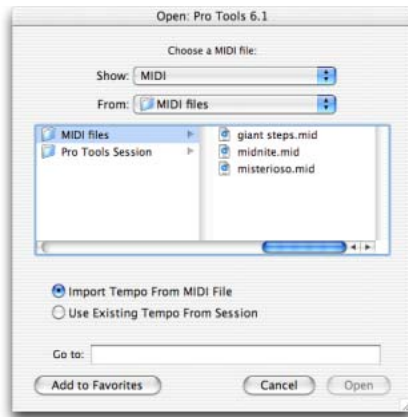

*Import MIDI dialog*

- 3 To import the MIDI file's tempo and meter tracks, select the Import Tempo From MIDI File option.

This option overwrites existing meter and tempo events in the current session. If you don't want this, select Use Existing Tempo From Session.

4 Click Open (Windows) or Import (Macintosh). If prompted, specify whether you want to Keep or Discard existing MIDI tracks and regions in the current session.

The MIDI data is imported to new MIDI tracks, and also appears as regions in the MIDI Regions List.

**▲** *If the Standard MIDI File contains markers, they are only imported if the current session does not contain any markers.*

5 In the Mix window, click the MIDI Device/Channel Selector for each new track and assign a MIDI instrument and channel.

#### To import a Standard MIDI File into the MIDI Regions List:

1 Choose Import MIDI from the MIDI Regions List pop-up menu.

2 Select the MIDI file you want to import.

3 To import the MIDI file's tempo and meter tracks, select the option for Import Tempo From MIDI File.

This option overwrites existing meter and tempo events in the current session. If you don't want this, make sure to instead select Use Existing Tempo From Session.

4 Click Open (Windows) or Import (Macintosh). If prompted, specify whether you want to Keep or Discard existing MIDI tracks and regions residing in the current session.

Pro Tools imports the MIDI data as regions and places them in the MIDI Regions List.

**▲** *If the Standard MIDI File contains markers, they are only imported if the current session does not contain any markers.*

5 Drag the new MIDI regions to existing MIDI tracks.

## Exporting MIDI Files

To export a session's MIDI tracks for use in another MIDI application, or for playback with an external (hardware) MIDI sequencer, you can save the tracks as a Standard MIDI File.

When exporting, the session tracks can be merged to a single, multichannel track (Type 0), or they can be saved as multiple tracks (Type 1).

#### To export all MIDI tracks in the current session:

1 Make sure to unmute any MIDI tracks in the session that you want to export.

2 Choose File > Export MIDI.

3 Specify a folder destination and name for the MIDI file.

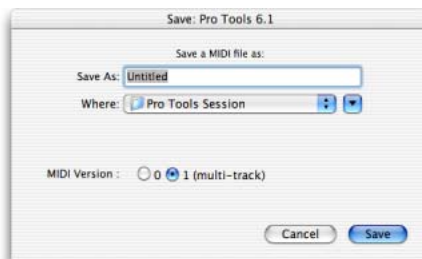

#### Export MIDI dialog

4 In the MIDI Version field, select whether the Standard MIDI File will be Type 0 (merged, single track) or Type 1 (multi-track).

5 Click Save. Pro Tools exports all MIDI tracks in the current session to a Standard MIDI File and writes it to your hard drive. Exported MIDI information includes notes, controller events, program changes, and System Exclusive data, as well as events for tempo, meter, and markers.

The SMPTE start time for the session is also exported. This ensures that the exported tracks, when played from another MIDI application, will align with the correct SMPTE frames, and also sync correctly to tape and video devices, or Pro Tools.

Refer to your third-party MIDI sequencer documentation to determine whether it supports importing SMPTE start times from MIDI files.

### **Not Exported with MIDI Files**

Mute automation and muted regions do not affect exported MIDI. As long as a track is not muted by clicking its Mute button, all of its MIDI data is exported.

When exporting MIDI files from Pro Tools, device assignments for tracks are not retained (though channel assignments are). If you export MIDI tracks from Pro Tools and later re-import them, you'll need to reassign the tracks to devices in your studio.

All playlist information for MIDI tracks is lost when exporting. For example, tracks that previously contained dozens of MIDI regions will be flattened and only contain single regions after exporting and re-importing.





# Chapter 10: File Management and Compatibility

When you work with Pro Tools, you will encounter several different kinds of computer files. Pro Tools systems require that you keep certain files in specific hard drive locations in order to function properly.

- ◆ Pro Tools software files should be located on your Startup drive (the drive that contains your operating system and other system-related files).
- ◆ On Pro Tools TDM systems, data files (session files, audio files and fade files) can be located on any compatible drive connected to the internal SCSI bus or the external SCSI bus of your computer, or to a SCSI host bus adapter card in your computer. For maximum performance, SCSI drives are recommended for Pro Tools TDM systems. FireWire and ATA/IDE drives are also supported. See the Digidesign Web site for more information ([www.digidesign.com/compato](http://www.digidesign.com/compato)).
- ◆ On Pro Tools LE systems, data files can be located on any compatible hard drive connected to your computer's internal or external ATA/IDE, FireWire, or SCSI busses.

**⚠** *Although Pro Tools will let you record to your system drive, this is generally not recommended. You should record to system drives only when necessary—for example, if your computer system has just one hard drive, or if your other hard drives are completely out of space.*

---

## Audio File Management

### Unique File IDs

Pro Tools tags each audio file in a session with a unique identifier that allows it to distinguish a particular file even if its name or location has changed.

### Locating Audio Files

With Pro Tools, you manage *links* to audio and other media files with the Relink window. In addition, Pro Tools classifies storage volumes according to their suitability for *performance* (recording or playback) or *transfer* (storage or copying) of audio and other media files. Audio files must be stored on suitable Performance volumes and be properly linked in order to be playable in a Pro Tools session.

 *For complete information on storage volume classifications, refer to the DigiBase Guide.*

When you open a session, if Pro Tools determines that audio files are not located on a Performance volume, or if it is unable to locate audio files contained in the session, you can locate or copy the files in order to play back the session. This process is called *relinking*.

## Transfer Files

Transfer files reside on volumes unsuitable for playback, such as CD-ROMs or network drives.

### To open a session containing Transfer files:

- 1 Open the Pro Tools session. If any files are on a volume unsuitable for playback, Pro Tools posts a warning.
- 2 Do one of the following:
  - Click Yes to open the Copy and Relink dialog.
  - Click No to open the session with all Transfer files offline.

### To make Transfer files playable in the current session:

- 1 Choose Windows > Show Project Browser.
- 2 Double-click the Audio Files folder to display all of the audio files.
- 3 Choose Select Transfer Files from the Browser menu.
- 4 Choose Copy and Relink from the Browser menu.
- 5 Specify a location for the copied files on a valid Performance volume.
- 6 Click OK.

 For complete information on relinking Transfer files, refer to the *DigiBase Guide*.

## Missing Files

A file is missing if it is not found in the same location as when the session was last saved.

### To open a session with missing files:

- 1 Open the Pro Tools session. If any files are missing, Pro Tools posts a Missing Files warning.

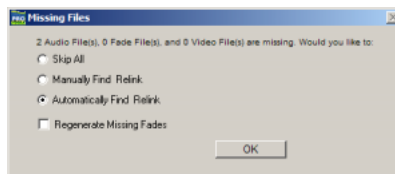

*Missing files warning when opening a session*

- 2 Choose one of the following options:

**Skip All** Ignores all missing files and fades. The missing files will be offline in the session.

**Manually Find and Relink** Opens the Relink window, where you can search, compare, verify, and relink missing files.

**Automatically Find and Relink** Searches all Performance volumes for all missing files with matching name, unique file ID, format, and length, and automatically commits links to missing files where possible.

- 3 To exclude fades from the relinking process, and have them recalculated instead, select Regenerate Missing Fades.

- 4 Click OK.

 For complete information on relinking missing files, refer to the *DigiBase Guide*.

---

## WAV File Compatibility

### Convert Imported WAV files to AES31/BroadcastWave

Pro Tools always creates AES31/Broadcast compliant BWF (.WAV) files when the file originates in Pro Tools. This option makes *imported* WAV files compliant with the AES31/EBU Broadcast standard.

AES31/Broadcast Wave is a variant of the standard audio WAV file type. The AES31 format contains information beyond the raw PCM audio data, such as SMPTE time stamps.

This variant complies with standards set by the EBU (European Broadcasters Union), and the AES (Audio Engineering Society). Choose this option to ensure compatibility with other workstations that recognize this file type.

### To make imported WAV files compliant with the AES31/EBU Broadcast standard:

1 In Pro Tools 6.1 or above, choose Setups > Preferences > Operation.

– or –

In Pro Tools 6.0.x and lower, choose Setups > Preferences > Compatibility.

2 Select Convert imported “wav” files to AES31/BroadcastWave.

3 Click Done.

---

## Creating Macintosh and PC Compatible Sessions

With the Enforce Mac/PC Compatibility option you can create and save Pro Tools sessions that are compatible on both Macintosh and Windows.

### Cross-Platform Session Limits

#### Audio File Types

Sound Designer II (SDII) files cannot be read by Windows systems. Therefore, when creating Mac and Windows compatible session files, the audio file type for the session must be either AIFF or WAV.

#### File Name Extensions

For cross-platform compatibility, all files in a session must have a 3-letter file extension added to the file name. Pro Tools 5.1 and higher session files have the extension “.pts,” and Pro Tools 5 sessions have the extension “.pt5.” Wave files have the “.wav” file extension, and AIFF files have the “.aif” file extension.

#### Incompatible ASCII Characters

Region names, track names, file names, and plug-in settings cannot use ASCII characters that are incompatible with either system.

When creating a new name, if an incompatibility is detected when Mac/PC Compatibility mode is enabled, a dialog will appear that prompts you to type a new name. When you import files into a session that is set for Mac/PC compatibility, incompatible characters are converted to underscores (“\_”).

The following characters cannot be used in PC or in Mac/PC compatible sessions:

/ (slash)

\ (backslash)

: (colon)

\* (asterisk)

? (question mark)

“ (quotation marks)

< (less-than symbol)

> (greater-than symbol)

| (vertical line or pipe)

Any character typed with the Command key

## Creating and Saving Cross-Platform Sessions

**To create a session that is compatible with Macintosh and Windows:**

- 1 Choose File > New Session.
- 2 Choose the drive where you want to save the session. The session should be created on a dedicated audio drive.
- 3 Enter a name for the session.
- 4 In the New Session dialog, set the Audio File Type to AIFF or BWF (.WAV). These file formats are compatible with either platform.

5 Set the Sample Rate and Bit Depth for the session.

6 Select the I/O Settings to use for the session. Several pre-configured I/O Settings are included with your system, or you can choose custom I/O Settings that you have created. See Chapter 7, “I/O Setup” for more information.

7 Select “Enforce Mac/PC Compatibility.” This option must be selected to make the session cross-platform compatible.

8 Click Save.

**To save an existing session that is compatible with Macintosh and Windows:**

- 1 Choose File > Save Session Copy In.
- 2 In the Save Session Copy dialog, choose a destination and enter a name for the new session file.
- 3 Set the Audio File Type to AIFF or BWF (.WAV). These file formats are compatible with either platform.
- 4 Set the Sample Rate and Bit Depth for the session.
- 5 Select “Enforce Mac/PC Compatibility.” This option must be selected to make the session cross-platform compatible.
- 6 Select the Items to Copy to the new session.
- 7 Click Save.

If the session previously used SDII files, the files are converted to the new audio file format.

---

## Moving Sessions Between Platforms with MacOpener (Using HFS/HFS+ Drives)

MacOpener 6.0.5 and higher lets you mount HFS/HFS+ drives on a Windows-based Pro Tools system, as a Transfer drive. See “Creating and Saving Cross-Platform Sessions” on page 132.

 *The MacDrive Utility can be used instead of MacOpener. Refer to the MacDrive Website ([www.macdrive.com](http://www.macdrive.com)).*

To share Pro Tools sessions between Macintosh and Windows systems, select the “Enforce Mac/PC Compatibility” option when creating the session, or when saving a session copy.

 *While SDII files can be exported or converted on import, they cannot be used within Pro Tools sessions on Windows.*

### To install and configure the MacOpener demo included with Pro Tools (Windows):

- 1 Insert the Pro Tools Installer CD in your CD-ROM drive.
- 2 Locate and double-click the MacOpener installer file. Follow the onscreen instructions to install the MacOpener. After installation is complete, restart your computer.
- 3 Choose Start > Programs > MacOpener > MacOpener Driver Preferences.
- 4 Verify that the MacOpener Driver is enabled. Under Driver Settings, select “Enable MacOpener Driver.”
- 5 Under Extension Mapping, select “Do not add the PC extension to the Mac file name.”

 *All formatting and maintenance of HFS/HFS+ drives should be carried out when the drive is connected to a Macintosh.*

### MacOpener Performance Limitations

- To open a session from an HFS/HFS+ drive, the session must be created with Pro Tools 5.1.1 or higher. In addition, the session must not contain mixed audio file formats. To use mixed-format sessions in Pro Tools, first save a copy of the session and convert its files to a supported file format using the Save Session Copy In command.
- When using the Bounce To Disk command, the bounce destination must be a FAT/FAT32 or NTFS drive. Bouncing to HFS/HFS+ drives is not supported.
- Opening sessions is slower on HFS/HFS+ drives than FAT/FAT32 or NTFS drives.
- Because MacOpener must clear the disk cache after copying between HFS/HFS+ drives and FAT/FAT32 or NTFS drives, Pro Tools will launch very slowly after performing these disk copies.
- For SDII files to appear in the Import Audio dialog, you must set the File Of Type pop-up menu to “All Files.”
- On Pro Tools LE for Windows, if you select all files listed in the Import Audio dialog, and any these files have long names (13 or more characters), no files will be added to the import list when you click Convert All. These files can be added to the list by Shift-clicking their file names individually.



# Part III: Recording





# Chapter 11: Record Setup

Before you start recording, make sure your Pro Tools system is connected and configured properly. For details on connecting Pro Tools to your studio, refer to the *Getting Started Guide* that came with your system.

While some of the information in this chapter is relevant to recording MIDI, there are more specific setup details for MIDI recording in Chapter 13, “MIDI Recording.”

---

## Input Connections and Audio Levels

Digidesign TDM audio interfaces operate as line-level devices and offer no pre-amplification. Low-level sources like microphones and electric guitars need to be pre-amplified. You can do this with a quality mixing board or dedicated preamp (such as the Digidesign PRE).

 *The Digidesign PRE can be used as a stand-alone preamp with all Pro Tools systems, or it can be remote-controlled from within a Pro Tools session when used with a Pro Tools TDM system.*

The Digi 002 and Digi 002 Rack have four inputs with preamps, to which you can connect low-level signals, and four additional line-level inputs with switchable gain.

Mbox and the Digi 001 I/O have two inputs with preamps, to which you can connect low-level signals; the Digi 001 I/O also has six additional line-level inputs with switchable gain.

For all systems, volume and pan controls for tracks in Pro Tools only affect monitoring levels—not the recording input gain. The LED meters on audio interfaces indicate both full-code (highest level before clipping) and true clipping of Pro Tools output signals. The on-screen meters in Pro Tools indicate only true clipping.

## Digital Clipping

Clipping occurs when you feed a signal to a recorder or mixer that is louder or “hotter” than the device allows. On many analog tape decks, a little clipping adds a perceived warmth to the sound due to tape compression. In digital recording, however, clipping causes digital distortion, which is undesirable and should always be avoided.

## Set Input Levels High But Don't Clip

When you feed a signal into any audio recording system, including Pro Tools, you need to adjust the input level to optimize the dynamic range. Adjust the input signal to register as high as possible on your input meter without triggering the clipping indicator. If the input level is too low, you will not take full advantage of the dynamic range of your Pro Tools system. If the input level is too high, however, it will be clipped, and the performance ruined.

## Calibration Mode

### (TDM Systems Only)

You can use the Calibration mode in Pro Tools to adjust the input and output levels for your audio interface so they match those of your mixing console and other audio devices in your studio.

The 192 I/O has two sets of adjustable trim pots for its inputs, and two sets of adjustable trim pots for its outputs. Additionally, the reference level for the input can be set to +4 dBu or -10 dBV. The 888|24 I/O has adjustable trim pots for its inputs and outputs.

There are no input or output trims on the following TDM audio interfaces: 192 Digital I/O, 96 I/O, 96i I/O, 888|20 I/O, 1622 I/O, and ADAT Bridge I/O. Some Digidesign I/Os that do not have output trims (such as the 96i I/O) offer software-controllable input levels, adjustable from Setups > Hardware Setup (refer to the guide for your particular I/O).

 For more information on calibrating your audio interface, or using Calibration mode, see the 192 I/O Calibration Mode Instructions or the 888|24 I/O Guide.

---

## Record Enabling Tracks

To record to a track you must first record enable it with the Record Enable button. To record simultaneously to multiple tracks, you can record enable multiple audio or MIDI tracks.

When one or more tracks are record enabled, you can click the Record and Play buttons in the Transport window to start recording.

 MIDI tracks can be record enabled during playback or record. To record enable audio tracks, the Transport must be stopped, or TrackPunch (Pro Tools TDM 6.4 only) or QuickPunch must be enabled. For information on TrackPunch, see “TrackPunch Audio Recording” on page 194. For information on QuickPunch, see “QuickPunch Audio Recording” on page 191).

### To record enable an audio or MIDI track:

- From either the Edit or Mix window, click the track's Record Enable button to toggle record enable on or off for the track. The Record Enable button is lit when on; also, in the Mix window, the track's fader is highlighted.

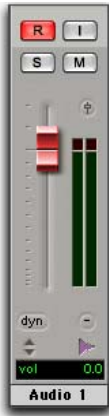

Mix window



Edit window

**Record-enabled audio track in Mix and Edit windows**  
(Pro Tools TDM 6.4)

### To record enable multiple audio tracks:

- 1 From either the Edit or Mix window, click each audio track's Record Enable button to toggle record enable on or off for each track.

 If Latch Record mode is not enabled, Shift-click each track's Record Enable button to toggle record enable on or off for each track. See "Latch Record Preference" on page 140.

### To record enable multiple MIDI tracks:

- From either the Edit or Mix window, Shift-click each MIDI track's Record Enable button to toggle record enable on or off for each track.

### To record enable MIDI tracks using the Up/Down Arrows:

- While pressing Control (Windows) or Command (Macintosh), press the Up/Down Arrows to record enable the previous or next MIDI track. The previous (or next) record track is no longer record enabled.



To keep the previous track record enabled while enabling new tracks, press Shift+Control+Up/Down (Windows) or Shift+Command+Up/Down (Macintosh).

### To record enable all audio or MIDI tracks:

- Alt-click (Windows) or Option-click (Macintosh) the Record Enable button to toggle record enable on or off for all audio or MIDI tracks.

### To record enable all selected audio or MIDI tracks:

- Alt-Shift-click (Windows) or Option-Shift-click (Macintosh) the Record Enable button on any selected audio or MIDI track to toggle record enable on or off for all selected audio or MIDI tracks.



While record enabling does not affect audio tracks that are grouped, you can select all tracks in a group by clicking directly to the left of the group's name in the Groups List. Then you can Shift-Alt-click (Windows) or Shift-Option-click (Macintosh) to record enable all selected tracks.

## Latch Record Preference

When the Latch Record Enable Buttons preference is selected, you can record enable additional audio tracks by clicking their Record Enable buttons while previously record-enabled tracks remain enabled. Latch Record Enable buttons are for audio tracks only.

When Latch Record Enable Buttons is deselected, record enabling a subsequent audio track will make the previously record-enabled audio track no longer record enabled.

### To enable Latch Record mode:

- 1 Choose Setups > Preferences.
- 2 Click the Operations tab.
- 3 Select Latch Record Enable Buttons.

## Record Safe Mode

Pro Tools provides a *Record Safe* mode that prevents tracks from being record enabled. Use Record Safe mode to protect important track recordings.

### To put an audio or MIDI track in Record Safe mode:

- Control-click (Windows) or Command-click (Macintosh) the track's Record Enable button. The Record Enable button is greyed out.

Control-click (Windows) or Command-click (Macintosh) again to take the track out of Record Safe mode.

### To put all tracks in Record Safe mode:

- Control-Alt-click (Windows) or Command-Option-click (Macintosh) the Record Enable button on any track.

Control-Alt-click (Windows) or Command-Option-click (Macintosh) again to take all tracks out of Record Safe mode.

### To put all currently selected tracks into Record Safe mode:

- Control-Alt-Shift-click (Windows) or Command-Option-Shift-click (Macintosh) the Record Enable button on any of the selected tracks to toggle them in and out of Record Safe mode.

---

## Record Monitoring Modes

### (Pro Tools LE Systems Only)

Pro Tools offers two modes of input monitoring during record, *Auto Input* monitoring or *Input Only* monitoring, which determine how input signals are monitored while recording audio.

### To choose a record monitoring mode:

- Choose Operations > Auto Input Monitor.  
– or –

Choose Operations > Input Only Monitor.



To toggle between *Auto Input* and *Input Only* modes, press *Alt+K* (Windows) or *Option+K* (Macintosh).

## Auto Input Monitoring

In this mode, when session playback is stopped, Pro Tools monitors audio input. When playback is started for a punch-in, Pro Tools monitors existing track material up until the punch point. While punched in, the input signal is monitored. On punch-out, monitoring switches back to the existing track material. This is similar to the auto-switching logic found on digital and analog multitrack tape machines.

When Auto Input monitoring is enabled, both the TrackInput button and the lower LED next to the Transport window appear gray.

 When using Auto Input, the switch back to monitoring track material on punch-out is not instantaneous. To get instantaneous monitor switching on punch-out, use TrackPunch (Pro Tools TDM 6.4 only) or QuickPunch. For information on TrackPunch, see “TrackPunch Audio Recording” on page 194. For information on QuickPunch, see “QuickPunch Audio Recording” on page 191).

## Input Only Monitoring

In this mode, when a track is record enabled, Pro Tools monitors audio input only, regardless of any punch-in/out selection.

When Input Only monitoring is enabled, the Green LED next to the Transport window appears green.



Green LED lights when Input Only Monitoring is selected

*Transport window*

## Monitor Levels for Record and Playback

Pro Tools remembers two different fader levels for monitoring each audio track: one for when the track is record enabled, and one for when it is *not* record enabled.

Pro Tools remembers these two states for fader levels automatically. If you adjust a fader when a track is record enabled and then turn off record enable for the track, the fader returns to its playback level.

When audio tracks are record enabled, their volume faders in the Mix window turn red, indicating that the record monitor level is active.

## Link Record and Play Faders

When the Operation Preference for “Link Record and Play Faders” is selected, Pro Tools does not keep track of record and play levels for audio tracks. In this case, record enabling an audio track has no effect on the fader level for the track. This lets you maintain a consistent mix regardless of whether you're recording or just listening.

---

## TrackInput Monitoring

### (Pro Tools TDM Systems Only)

TrackInput monitoring lets you toggle *individual* audio tracks between Auto Input and Input Only monitoring modes at any time, including during playback or recording. TrackInput provides the monitoring flexibility needed in dubbing and mixing, and is similar to “rehearse” mode on analog multitrack recorders and similar machines.

With the Digidesign MachineControl 2.0 option (available separately), TrackInput can also be remotely controlled from a SoundMaster and compatible devices through P2 protocol commands (with support for pec-direct paddles as supported on the synchronizer or console).

The TrackInput feature also makes it possible to toggle a track between Auto Input and Input Only monitoring mode regardless of whether or not the track is record enabled.

**To toggle the monitoring mode of audio tracks do one of the following:**

- To toggle individual tracks, click the TrackInput button for each track you want to toggle. The TrackInput button lights green.
- To toggle all tracks in the session, Alt-click (Windows) or Option-click (Macintosh) a Track-Input button. All the TrackInput buttons lights green.
- To toggle all selected tracks in the session, Alt-Shift-click (Windows) or Option-Shift-click (Macintosh) a selected track's TrackInput button. All the TrackInput buttons for the selected tracks lights green.

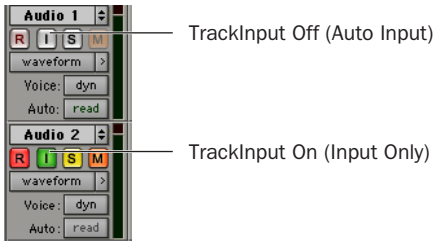

*TrackInput buttons in the Edit Window*

**To change the monitoring mode of all record-enabled tracks, do one of the following:**

- To change all record-enabled tracks to Auto Input monitoring mode, Choose Operations > Change Record Enabled Tracks to Auto Input.
- To change all record-enabled tracks to Input Only monitoring mode, Choose Operations > Change Record Enabled Tracks to Input Only.
- To toggle the monitoring mode of all record-enabled tracks between Input Only monitoring mode and Auto Input monitoring mode, use Alt-K (Windows) or Option-K (Macintosh).

## Monitoring Mode Preferences

For flexibility, TrackInput can be customized to remain selected regardless of track record status, or to automatically switch to Auto Input monitoring after a recording pass. This lets you optimize monitoring for a typical dubbing workflow (in which you might want tracks to remain in Input Only mode until explicitly switched to Auto Input monitoring) or a typical music tracking workflow (in which leaving a track in Input Only monitoring mode after recording can result in accidental double-monitoring).

**To customize TrackInput for recording:**

**1** Choose Setup > Preferences, and open the Operation page.

**2** Configure the setting for Disable “Input” When Disarming Track (In “Stop”) setting as appropriate.

- When enabled, taking an audio track out of record enable (any mode) takes it out of Input Only mode, regardless of the global monitor mode, and switches it to monitor audio from disk only.
- When not enabled, audio tracks will remain in Input Only monitoring mode until explicitly switched to Auto Input monitoring.

---

## Monitoring Latency

**(Pro Tools LE)**

Because Pro Tools LE uses the host processor in your computer for all audio processing, playback and recording, there is a small amount of audio delay, or latency, in the system. This latency amount is related to the H/W Buffer Size—the larger the buffer size the larger the latency.

You can reduce the amount of monitoring latency for Pro Tools LE systems by reducing the H/W Buffer Size. However, even at the smallest buffer size, there is still some latency. In addition, reducing the buffer size limits the number of simultaneous audio tracks you can record without encountering performance errors.

While there may be times when you want a larger buffer size, for the sake of higher track counts with more plug-ins, you'll generally want a smaller buffer size when recording audio that is monitored through your Pro Tools LE system.

If you are monitoring the recording source with an external mixer, before it is routed to Pro Tools, you will not hear any latency.

#### **To set the Hardware Buffer Size:**

- 1 Choose Setups > Playback Engine.
- 2 Choose the number of samples from the H/W Buffer Size pop-up menu.
- 3 Click OK.

 *Computers with slower CPUs may not be able to use the 128 buffer size without encountering performance errors.*

## **Zero Latency Monitoring**

### **(Mbox Only)**

Mbox gives you the ability to monitor your analog input signals while recording, without hearing any latency. This zero-latency analog monitoring is controlled by the Mbox front panel Mix knob, which you can use to blend and adjust the ratio between the Mbox analog input and Pro Tools playback. For more information, refer to the *Mbox Basics Guide* or the *Getting Started with Mbox Guide*.

## **Low Latency Monitoring**

### **(Digi 002, Digi 002 Rack, and Digi 001 Only)**

Digi 002, Digi 002 Rack, and Digi 001 systems can use the Low Latency Monitoring option to record with an extremely small amount of monitoring latency, to as many tracks as each system supports.

#### **To use Low Latency Monitoring:**

- 1 Record enable audio tracks by clicking their Record Enable buttons. Only tracks with inputs set to an audio interface (not a bus) use Low Latency Monitoring.
- 2 From the Output Selector, assign each track to either Output 1 or Output 2. Only tracks assigned to these outputs use Low Latency Monitoring.
- 3 Select Operations > Low Latency Monitoring.

When Low Latency Monitoring is enabled, any plug-ins and sends assigned to record-enabled tracks (routed to Outputs 1–2) are automatically bypassed, and must remain bypassed. Also, these tracks will not register on meters for Master Faders.

## **Low Latency Monitoring and Bounce To Disk**

With Low Latency Monitoring enabled, only audio tracks are included with the Bounce To Disk command—Auxiliary Input tracks are ignored.

To include any Auxiliary Inputs' audio when bouncing to disk, Auxiliary Inputs must be recorded to new audio tracks (see "Recording to Tracks" on page 481.)

---

## Low Latency Monitoring During Recording

### (HD-series Systems with Pro Tools 6.4 Only)

If you choose to record with Delay Compensation active, Pro Tools automatically suspends delay compensation to provide a low-latency monitor path through the main outputs of the record-enabled tracks. When an audio track is armed for recording (in stop), TrackInput-enabled, or punched in, the track's delay compensation is automatically suspended, and the Track Compensation indicator displays zero.

Delay compensation can be intentionally applied to audio tracks regardless of record status or input mode.

#### To apply delay compensation to automatically bypassed tracks:

- Start-Control-click (Windows) or Command-Control-click (Macintosh) the Track Compensation indicator. Track delay will be applied to the track and the Track Compensation Indicator will display in blue.

 For more information about Delay Compensation, see “Delay Compensation” on page 428.

---

## Default Track Names

When creating new audio and MIDI tracks, Pro Tools names them as either “Audio” or “MIDI” and numbers them consecutively. For example, when you create two new audio tracks, their default names are “Audio 1” and “Audio 2.” You can rename tracks and also log comments for each track.

Track names define new file and region names when recording to a track. See “Naming Tracks” on page 91.

### Default Names for Audio Files and Regions

When recording to an audio track, the resulting file and region names are based on the name of the track. For example, after recording for the first time on a track called “Electric Gtr,” an audio file is created with the name “Electric Gtr\_01.” In addition, a region appears in the Audio Regions List with the name “Electric Gtr\_01.” This region is a whole-file region.

Subsequent record takes on the same track are named identically, but the digits (indicating the take number) are incremented (for example, “Electric Gtr\_02.”) A second set of digits (such as used in “Electric Gtr\_01-01”) indicates a region *auto-created* from an edit.

 *TrackPunch (Pro Tools TDM 6.4 only) and QuickPunch modes use a different method for numbering regions. For details, see “Region and Take Numbering with QuickPunch” on page 194.*

When recording MIDI tracks, a similar naming scheme is used, though with only one set of digits. For example, after recording to a track called “Synth 1,” a region is created called “Synth 1-01.” Subsequent regions for that track, generating either from additional record takes or region edits, are numbered sequentially (for example, “Synth 1-02”).

### Names for Stereo Audio Tracks

When recording to stereo audio tracks, audio file and region names for the left and right channels are appended with a “.L” and “.R” suffix.



## Names for Multichannel Tracks

### (TDM Systems Only)

When recording to multichannel surround tracks, audio file and region names for each channel are appended with the following suffixes.

Multichannel Format	File and Region Suffixes
LCR	L, C, R
Quad	L, R, Ls, Rs
LCRS	L, C, R, S
5.0	L, C, R, Ls, Rs
5.1	L, C, R, Ls, Rs, LFE
6.0	L, C, R, Ls, Cs, Rs, LFE
6.1	L, C, R, Ls, Cs, Rs
7.0	L, Lc, C, R, Rc, Ls, Rs
7.1	L, Lc, C, R, Rc, Ls, Rs, LFE

## Disk Allocation

By default, Pro Tools records audio files to the Audio Files folder inside the session folder. You can use the Disk Allocation dialog to specify other locations for your audio files for each audio track.

Hard drives that are full do not appear in the Disk Allocation dialog.

To increase system performance, Pro Tools can record and play each track from a different hard drive. You can also automatically distribute any newly created tracks to multiple audio drives with Round Robin Allocation.

### To allocate the audio drives in your system:

- 1 Choose Setups > Disk Allocation.
- 2 In the Disk Allocation dialog, assign a hard drive for each track by clicking in the Root Media Folder column and selecting a volume from the Disk Allocation pop-up menu.

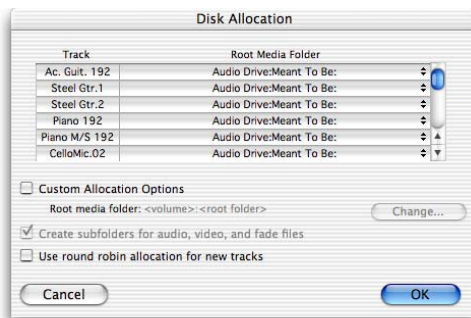

### Disk Allocation dialog

Only drives designated as R (Play and Record) can be selected in the Disk Allocation dialog. For more information, see the *DigiBase Guide*.

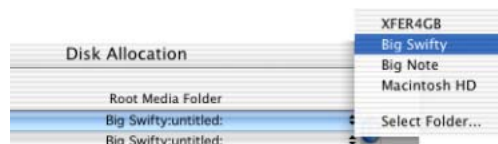

### Disk Allocation pop-up menu

A folder with the session name is created on each hard drive, containing subfolders for audio and fade files.

- To assign all tracks to the same hard drive, press Alt (Windows) or Option (Macintosh) while selecting a drive name.
- To make a continuous selection, Shift-click a track name (in the Track column) to extend the selection to include already-selected tracks and all tracks in between.

- To make a non-contiguous selection, Control-click (Windows) or Command-click (Macintosh) a track name in the Track column to extend the selection to include already-selected tracks without including tracks in-between.

**3** To save recorded audio files to an existing folder (without creating another session folder), select Customize Allocation Options, then click the Change button and choose the folder. To create subfolders in this folder, select “Create Subfolders for audio, video, and fade files.”

**4** To automatically distribute any newly created tracks among the drives connected to your system, select “Use Round Robin Allocation for New Tracks.”

If you are using Round Robin Allocation and want audio to be recorded to your system’s start-up drive, do the following:

- Open the Workspace browser and set the Volume Designator for your system volume to R (Record and Playback). See “Workspace Volume Designation” on page 147.

 *Round Robin Allocation is not supported with partitioned hard drives.*

 *If you want to exclude individual, valid, mounted volumes from Round Robin Allocation passes, open the Workspace browser and make the volume safe, by designating it as P (Playback only) or T (Transfer).*

**5** When you are finished, click OK.

## **Saving Disk Allocation Settings**

To save Disk Allocation settings for use with future sessions, save the session as a template. For details, see “Creating Custom Session Templates” on page 51.

## **Disk Allocation and Cross-Platform Sessions**

Pro Tools for Windows supports recording and playback of audio from multiple hard drives, but to ensure cross-platform operation, it also requires that Macintosh Pro Tools sessions and their associated audio files be on Macintosh-formatted (HFS or HFS+) drives.

Similarly, Windows sessions and their associated audio files must reside on Windows-formatted (FAT32 or NTFS) drives. If you want to share sessions between Windows and Macintosh platforms, consider these restrictions when allocating tracks to drives.

## Reallocating Tracks

When opening a session where some of the previously assigned hard drives are no longer available (or don't match the current session platform), Pro Tools automatically reassigns tracks to the volume where the session file is stored. In such cases, use Disk Allocation if you need to re-allocate tracks to other drives.



*Reallocating tracks does not affect the audio that has been previously recorded. Reallocating tracks only affects where new audio recording will be saved.*

## Workspace Volume Designation

The Workspace volume designation can alter disk availability, thus affecting Disk Allocation. From the Workspace browser, you may designate volumes as Record, Playback, or Transfer. If you change a drive's designation, making it read-only (Play Only or Transfer), you will need to check the Disk Allocation for any tracks formerly allocated to that drive. For more information, see the *DigiBase Guide*.

## Recording to the System Volume

Though Pro Tools will let you record to your system volume, this is generally not recommended. Performance for audio recording and playback on system drives is worse than on non-system hard drives.

You should record to system drives only when absolutely necessary—if your computer system has just the one hard drive, or if your other hard drives are completely out of space.

By default, the system volume is not included in Round Robin Allocation (regardless of volume designation in the Workspace browser). To include the System Volume in Round Robin Allocations, see “To allocate the audio drives in your system:” on page 145.

---

## Allocating Hard Drive Space for Recording

The Operation Preference for Open Ended Record Allocation determines how much of your available hard drive space is allocated whenever you record into one or more tracks in Pro Tools.

When this allocation preference is set to Use All Available Space, the drive's entire available space is allocated. This setting lets you record lengthy takes, or longer sessions.

However, when allocating all available space, Pro Tools may take a little longer to begin recording. You can reduce this delay by allocating a specific amount of time for recording.



*You can also avoid recording delays by putting Pro Tools in Record Pause mode before beginning to record. See “Record Pause Mode” on page 161.*

In general, the Use All Available Space preference makes hard drives work harder. In addition to record and punch lag times, many systems see better overall recording performance when the Open Ended Record Allocation is limited.

**To allocate a specific amount of time to recording:**

- 1 Choose Setups > Preferences and click Operation.
- 2 Under the Open Ended Record Allocation option, select Limit To and enter the number of minutes to be allocated.



**Open Ended Record Allocation, Operation Preference**

The number of minutes specified is allocated for each record-enabled track.

- 3 When you are finished, click Done.

 Choose Windows > Show Disk Space to check the current available space on your drives.

---

## Record Modes

For recording audio, Pro Tools has four record modes:

- Nondestructive Record (Default)
- Destructive Record
- Loop Record
- QuickPunch
- TrackPunch (HD Only)

To enable Destructive Record, Loop Record, QuickPunch or TrackPunch, select them from the Operations menu. If none of these record modes are selected, Pro Tools is in normal Nondestructive Record mode.



**Destructive Record mode enabled**

The record mode can also be switched by Right-clicking (Windows and Mac OS X) or Control-clicking (Macintosh) the Transport Record Button. This cycles through the modes with the Record button changing to indicate the currently selected mode: blank for Nondestructive, “D” for Destructive, a loop symbol for Loop Record, “P” for QuickPunch and “T” for TrackPunch.

 When recording, you can preserve disk space by removing unwanted record takes (see “Removing Unwanted Regions” on page 313) and compacting audio files (see “Use this “power delete mode” with caution, since deletion of these files cannot be undone.” on page 313).

## Nondestructive Record Mode

In normal Nondestructive Record mode, Pro Tools records audio nondestructively, which means that if you record over a track’s existing regions, the audio is not erased from your hard drive. Both the new and old audio files remain on your hard drive, available as regions from the Audio Regions List.

In Nondestructive Record mode, the record range can be defined by selecting a range in the Ruler or in a track's playlist, or by specifying start and end points in the Transport window. If there is no selection, recording begins from the current cursor location and continues until the Transport's Stop button is clicked.

 *To set a record range by selecting within a track's playlist, the Edit and Timeline selections must be linked. See "Linking or Unlinking Edit and Timeline Selections" on page 245.*

The pre- and post-roll settings allow material to be heard up to and after the start and end points, which is useful when punch recording (see "Punch Recording Audio" on page 163).

### **Destructive Record Mode**

In Destructive Record mode, recording over existing regions replaces the original audio permanently, which allows you to keep disk use to a minimum. However, if you have sufficient drive space, it is usually best to use Pro Tools in Nondestructive Record mode, to avoid losing any previously recorded material.

When defining the record range and setting pre- and post-roll, Destructive Record mode works the same as Nondestructive mode.

Unlike the other record modes, it is not possible to cancel or Undo record takes when using Destructive Record mode (see "Canceling a Record Take" on page 160).

### **Loop Record Mode**

Loop Record mode allows you to record take after take (nondestructively) while the same section of audio repeats. This is a convenient technique for quickly recording multiple takes of a part without losing spontaneity.

The time range that is looped and recorded—which must be at least one second in length—is defined by selecting a range in the Ruler or in a track's playlist, or by specifying start and end points in the Transport window. The pre-roll setting, if enabled, is used during the first record pass, but on each successive loop the pre- and post-roll times are ignored.

 *To set a record range by selecting within a track's playlist, the Edit and Timeline selections must be linked. See "Linking or Unlinking Edit and Timeline Selections" on page 245.*

When using Loop Record mode, each successive take appears as a region in the Audio Regions List and each is numbered sequentially. The various takes, which are identical in length and start time, are easily auditioned and placed in the track at the correct location with the Takes List pop-up menu (see "Auditioning Record Takes" on page 166).

### **QuickPunch**

QuickPunch gives you the ability to manually and instantaneously *punch in* (initiate recording) and *punch out* (stop recording) on record-enabled audio tracks during playback by clicking the Transport's Record button. Recording with QuickPunch is nondestructive.

When using QuickPunch, Pro Tools begins recording a new file when playback begins, automatically generating regions in that file at each punch in/out point. These regions appear in the track's playlist; and the complete audio file appears in the Regions List along with the QuickPunch created regions. Up to 200 of these "running punches" can be performed in a single pass.

Though you can punch record in the other record modes by manually specifying the record range, only QuickPunch provides instantaneous monitor switching on punch-out.

## TrackPunch

TrackPunch lets individual tracks be punched in, punched out, and taken out of record enable without interrupting online recording and playback. When using Digidesign MachineControl software in Remote 9-Pin Deck Emulation mode, TrackPunch (and TrackInput monitoring) can be controlled through P2 commands. Control surfaces (such as ProControl, Control|24, and Command|8) also support TrackPunch

TrackPunch is a non-destructive recording mode. When a track is TrackPunch-enabled, Pro Tools begins recording a new file when playback begins. During playback, you may record arm or disarm, or punch in or out a combination of any or all TrackPunch enabled tracks.

TrackPunch automatically creates regions in that file at each punch-in and punch-out point. These regions appear in the track's playlist, and the complete audio file appears in the Regions List along with the TrackPunch created regions. Up to 200 of these "running punches" can be performed in a single pass.

## The Record Modes and MIDI

In addition to the five record modes, there is also a MIDI Merge button in the Transport window that determines how MIDI is recorded. When enabled (*Merge* mode), recording over ex-

isting MIDI regions results in the new data being merged with the old. When the MIDI Merge button is deselected (*Replace* mode), the new material replaces the old.

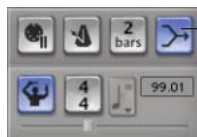

*MIDI Merge enabled*

MIDI recording works the same whether using Nondestructive or Destructive Record mode. In addition, neither QuickPunch nor TrackPunch need to be enabled to punch on-the-fly with MIDI—this capability is available in Nondestructive and Destructive Record modes.

Unlike audio loop recording, the state of the MIDI Merge toggle determines whether existing material is replaced or merged.

Unless MIDI Merge is enabled, MIDI recording is destructive (though you can undo a MIDI record pass), either overwriting or adding to region material. One exception to this rule is when Loop Record mode is enabled; in this mode, existing track regions are replaced with new regions when new material is recorded. The old regions remain intact and available from the MIDI Regions List, and from the Takes List pop-up menu. In Loop Record mode, MIDI Merge has no effect, so its button is dimmed.

## Recording with a Click

If you intend to work with MIDI tracks in your session, or if the audio you're working with is bar and beat-oriented, you can record your tracks while listening to a *click*. This ensures that recorded material, both MIDI and audio, will align with the session's bar and beat boundaries.

When your track material lines up with the beats, you can take advantage of some useful editing functions in Pro Tools, such as quantizing MIDI and audio regions, quantizing individual MIDI notes, and copying and pasting measures and song sections in Grid mode.

 *Material that is recorded without listening to a click can still be aligned to bar and beat boundaries in Pro Tools with Beat Detective (see Chapter 22, "Beat Detective"), or use the Identify Beat command to determine the tempo.*

Pro Tools provides a built-in click generator, the DigiRack Click plug-in. Click includes presets with different click sounds, supports accented and unaccented click sounds, and lets you adjust their volumes. Click is integrated directly into Pro Tools, avoiding MIDI time delays. Refer to the *DigiRack Plug-Ins Guide* for details.

Pro Tools also provides options and controls for driving a click using MIDI. The following steps are for configuring and enabling a click using MIDI.

### To configure click options:

1 Choose MIDI > Click Options.

– or –

Double-click the Click or Countoff button in the Transport window.

2 In the Click/Countoff Options dialog, do one of the following:

- If using the DigiRack Click plug-in, select None in the Output pop-up menu. (For information on using the Click plug-in, see the *DigiRack Plug-Ins Guide*.)

– or –

- If driving a click using MIDI, select the port number (device) and channel that will play the click from the Output pop-up menu.

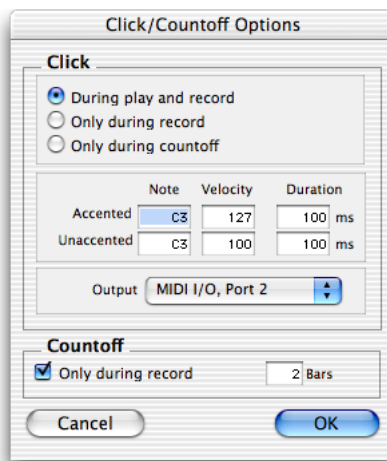

*Click/Countoff Options dialog*

3 For the accented and unaccented notes, specify the note, velocity, and duration with the numeric keypad. If connected, you can also play new note values on your MIDI controller keyboard.

When listening to the click in your Pro Tools sessions, the accented note sounds on the first beat of each measure and the unaccented note sounds on the remaining beats.

4 Select whether the click is heard “During play and record,” or “Only during record,” or “Only during countoff.”

5 If using a countoff, specify the number of Bars to be counted off. To hear the countoff only when recording, select that option.

6 Click OK.

#### To enable a click from the MIDI menu:

- Choose MIDI > Click.

#### To enable a click in the Transport:

1 To view the MIDI controls in the Transport window, select Display > Transport Window Shows > MIDI Controls.



Transport Window with MIDI Controls

2 In the Transport window, click the Click button so it becomes highlighted.



Click enabled

3 To use a *countoff* when recording or playing, click the Countoff button in the Transport window so it too becomes highlighted.

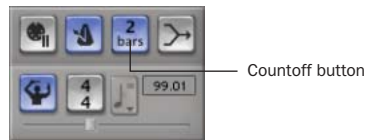

Countoff enabled

Hearing the countoff before recording is helpful in getting the feel for the tempo before you begin playing. The Countoff button in the Transport window displays the number of bars to be counted off.

 *The countoff is ignored when Pro Tools is online and syncing to SMPTE time code.*

#### Wait for Note and Countoff

Wait for Note and Countoff are mutually exclusive and cannot both be enabled at the same time. If, for instance, Countoff is enabled and you click the Wait for Note button, Countoff is disabled.



## Setting the Default Meter and Tempo

### Setting the Default Meter

When opening a new session in Pro Tools, the meter defaults to 4/4. If you intend to record with a click and are working with a different meter, make sure to set the default meter accordingly.

If a session's meter does not match the music you're recording, the accented clicks will not line up with what you're playing, and, as a result, the recorded material may not align with the bars and beats in the Edit window.

 *On TDM systems, Beat Detective requires identical meters to work with DigiGrooves. For example, if Beat Detective extracts the feel from a bar of 7/4, it can only be applied to another bar of 7/4*

Meter events, which can occur anywhere within a Pro Tools session, are stored in the Meter Track and appear in the Meter Ruler. For more information on inserting and editing meter events, see "Meter Events" on page 321.

#### To set the default meter for a session:

- 1 Choose Windows > Show Tempo/Meter.

– or –

Double-click the Meter button in the Transport window.



Meter button

- 2 Enter the Meter you will use for the session and set the Location to 1|1|000 (so the inserted meter event replaces the default one).

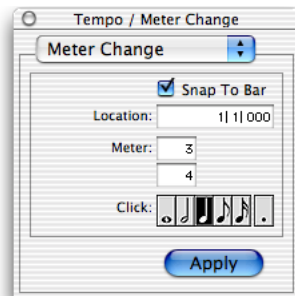

Tempo/Meter Change window

- 3 Choose a note value for the number of clicks to sound in each measure.
- 4 Click Apply to insert the new meter event.

### Setting the Default Tempo

When opening a new session in Pro Tools, the tempo defaults to 120 BPM. If you intend to record with a click and are working with a different tempo, make sure to set the default tempo accordingly. If you know the tempo you will use for the session, you can insert a tempo event at the beginning of the Tempo Track.

Tempo events, which can occur anywhere within a Pro Tools session, are stored in the Tempo Track and appear in the Tempo Ruler. For more information on inserting and editing tempo events, see "Tempo Events" on page 315.

### To insert a default tempo event:

1 Choose Windows > Show Tempo/Meter.

– or –

Double-click the Meter button in the Transport window.

2 At the top of the Tempo/Meter Change window, choose Tempo Change from the pop-up menu.

3 Enter the BPM value you will use for the session and set the Location to 1|1|000 (so the inserted tempo event replaces the default tempo).

4 To base the BPM value on something other than the default quarter-note, select another note value.

5 Click Apply to insert the new tempo event.

See “Default Tempo” on page 318 for more information on the default tempo.

### Using Manual Tempo Mode

In *Manual Tempo* mode, Pro Tools can ignore the tempo events in the Tempo Track and instead play back a Manual Tempo. This tempo can be set with the Tempo slider, or if you're not sure of the actual tempo, by tapping in the tempo.

While you can adjust the Manual Tempo during playback, doing so will momentarily interrupt playback.

#### To set the Manual Tempo with the Tempo slider:

1 To view the MIDI controls in the Transport window, select Display > Transport Window Shows > MIDI Controls.

In the Transport window, click the Conductor button so it becomes unhighlighted. Pro Tools switches to Manual Tempo mode. In this mode, any tempo events in the Tempo Track are ignored.



#### Manual Tempo mode enabled

2 To base the BPM value on something other than the default quarter-note, change the note value in the Beat Value pop-up menu (just to the left of the Tap button).

3 To enter a new tempo, drag the horizontal Tempo slider in the Transport window.

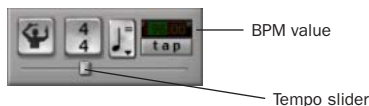

#### Tempo slider

For finer resolution with the Tempo slider, press For Control (Windows) or Command (Macintosh) while dragging.

#### To exit Manual Tempo mode and enable the Tempo Track:

■ Click the Conductor button in the Transport window so it becomes highlighted.

#### To set the Manual Tempo with the Tap button:

1 To view the MIDI controls in the Transport window, select Display > Transport Window Shows > MIDI Controls.

2 In the Transport window, click the Conductor button so it becomes unhighlighted. Pro Tools switches to Manual Tempo mode. In this mode, any tempo events in the Tempo Track are ignored.

3 Click the Tap button repeatedly at the new tempo.



*Tap button*

– Or –

Click in the Tempo field so it becomes highlighted and tap in the tempo by playing a note repeatedly at the new tempo on your MIDI keyboard controller.

To compute the new tempo, Pro Tools requires at least four taps (each of which is displayed in the Tap area when received). The computed BPM value appears in the Transport's Tempo field.



*Tempo Taps as reflected in Transport*

**To lock in the new tempo:**

- Take Pro Tools out of Manual Tempo mode by clicking the Conductor button, then insert a tempo event (with the new tempo) at the beginning of the Tempo Track.



# Chapter 12: Basic Audio Recording

## Recording an Audio Track

When recording from a mono source, record to a single, mono audio track in Pro Tools. A single, mono audio file is written to disk; the region appears in the playlist and in the Audio Regions List.

To record a stereo audio source in Pro Tools, record to a single, stereo audio track. A single, mono audio file is written to disk for each channel of a stereo track; one for the left channel, and one for the right channel; regions appear in the playlists for both channels. In addition, a multichannel (stereo) region appears in the Audio Regions List.

Recording multichannel tracks (Pro Tools TDM systems only) is very similar to recording stereo audio tracks. A single, mono audio file is written for each channel in the track, and regions appear in the playlists for each channel. In addition, a multichannel region for each track appears in the Audio Regions List.

 For more information on multichannel tracks, see “Multichannel Audio Tracks” on page 514.

### To configure an audio track for recording:

**1** Connect a mono or stereo sound source to the appropriate input of your audio hardware.

**2** If you want to start a new session with a different sample rate or Fader gain value, choose File > New Session, and select the sample rate. Click Save.

**3** Make sure to specify the format (analog or digital) of the inputs of the audio interface you will be using. Choose Setups > Hardware Setup, choose the audio interface, and select the format for the channel pair.

Some Digidesign I/O units (such as Mbox), have only two channels that can be set for analog or digital.

**4** If a track doesn’t already exist, choose File > New Track and specify 1 Mono or Stereo Audio Track, then click Create.

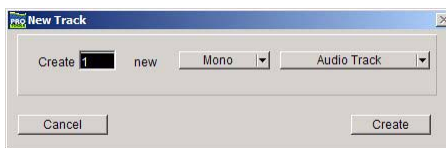

**New Track dialog**

 To auto-scroll the Track Type pop-up in the New Track dialog, press Control (Windows) or Command (Macintosh) and use the Up/Down Arrow keys.

To auto-scroll the Track Formats pop-up in the New Track dialog, press Control (Windows) or Command (Macintosh) and use the Left/Right Arrow keys.

**5** Rename the track. Track names are used to auto-name recorded audio files and regions. For more information, see “Default Track Names” on page 144.

**6** In the Mix window, use the track’s Input Selector to assign a hardware input.

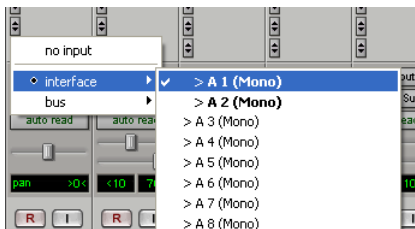

*Input Selector, Mix window*

– or –

In the Edit window, with I/O view enabled, use the track’s Input Selector to assign a hardware input.

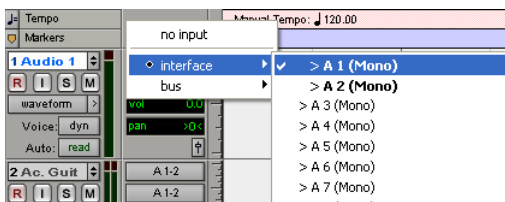

*Input Selector, Edit window*

**7** In the Mix window, click the track’s Output Selector and assign a hardware output.

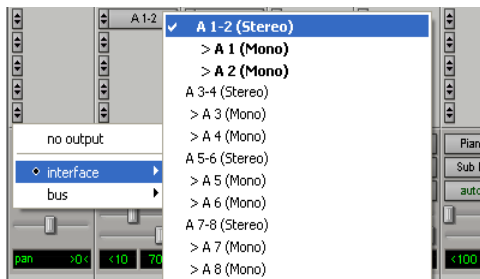

*Output Selector, Mix window*

– or –

In the Edit window, with I/O view enabled, use the track’s Output Selector to assign a hardware output.

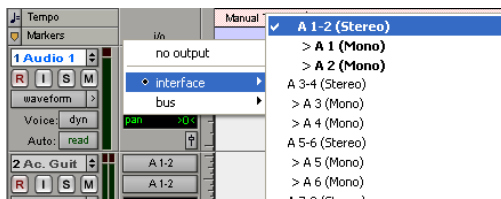

*Output Selector, Edit window*

8 In the Mix window, click the audio track's Record Enable button to record enable the track. The Record Enable buttons and volume faders for record-enabled tracks turn red.

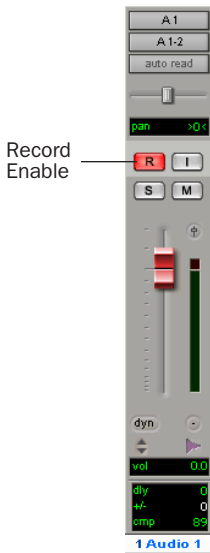

Record Enable button (Mix window)

– OR –

In the Edit window, click the audio track's Record Enable button to record enable the track.

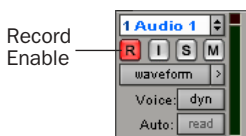

Record Enable button (Edit window)

9 Adjust the output level of your sound source (instrument, mixer, or preamp). Monitor the track's meter levels in Pro Tools to ensure that you get the highest possible signal without clipping.

10 In the Mix window, adjust the track's volume and pan faders. These settings are for monitoring purposes only and do not affect the recorded material.

– OR –

In the Output window for the track, adjust the track's volume fader and pan controls. These settings are for monitoring purposes only and do not affect the recorded material.

### To record to an audio track:

1 For HD systems (with Pro Tools 6.4), make sure that Use Delay Compensation is deselected in the Operations menu.

**!** *Digidesign recommends recording without Delay Compensation in most cases. For more information, see "Delay Compensation" on page 428.*

2 In the Operations menu, deselect Destructive Record, Loop Record, QuickPunch and Track-Punch.

3 Enable Click and Countoff in the Transport window if you want to use these features. For details, see "Recording with a Click" on page 151.

4 If you are using meter and tempo information, specify the session's default meter and tempo. For details, see "Setting the Default Meter and Tempo" on page 153.

5 In the Transport window, click Return to Zero so the start and end times are cleared. This ensures that you'll start recording from the beginning of the track.

6 Click Record in the Transport window to enter Record Ready mode. The Record button flashes.

7 When you are ready to begin recording, click Play. If using Countoff, Pro Tools counts off the specified number of measures and then begins recording.

**8** When you have finished recording, click Stop in the Transport window.

The newly recorded audio is written to disk and appears as an audio region in the track's playlist. The new audio region also appears in the Audio Regions List.

### To play back the audio track:

**1** Click the Record Enable button for the audio track so that it is no longer record enabled. Track volume faders now function as playback level controls.

 *If Auto Input Monitoring is enabled, you can click the Record button in the Transport window to exit Record Ready mode, then press Play, leaving the track record enabled. The track automatically switches to Playback mode when you press play, then back to Input mode when you stop. See "Auto Input Monitoring" on page 140.*

**2** In the Transport window, click Return to Zero to start playback from the beginning of the session.

**3** Click Play in the Transport window to start playback. Adjust the track's volume and pan faders.

## Undo or Cancel Audio Recording

Once you've recorded an audio track and the transport is stopped, you can undo the previous record take.

### To undo an audio recording:

- Once the Transport has been stopped, choose Edit > Undo Record Audio.

The track's playlist is restored to its previous state, and the following material is discarded:

- ◆ When in Loop Record mode, all takes from each record pass are discarded.
- ◆ When using TrackPunch or QuickPunch mode, all punches from the last recording pass are discarded.

 *If you undo a record pass during recording, Pro Tools will remove any previously undone record pass from the session, and gives you the option of deleting the previous record pass from your hard drive.*

### Canceling a Record Take

While recording, it is possible to discard the current record take. This removes the audio (recorded up to that point) from your hard drive and deletes the region from the track's playlist. This capability is not available in Destructive Record mode.

### To cancel a record take while recording:

- Press Control+period (Windows) or Command+period (Macintosh) before the Transport is stopped.

When using Loop Record mode, all takes from each record pass are discarded.



## Recording Multiple Audio Tracks

Pro Tools can record multiple audio tracks simultaneously, up to the track recording limits of your system. To record to multiple tracks, configure and record enable each track, then record. Follow the same steps as in “Recording an Audio Track” on page 157.

For each record-enabled track, a new audio file is written to disk and a new region is created and appears in the playlist. The new audio regions appear in the Audio Regions List.

---

## Record Shortcuts

In addition to clicking the Record button in the Transport window, you can also begin recording with the following keyboard shortcuts:

- Press F12 to start recording immediately.
- Press Control+Spacebar (Windows) or Command+Spacebar (Macintosh) to start recording.
- Press 3 on the Numeric Keypad (when the Numeric Keypad Mode is set to Transport) to start recording.

 *To initiate recording at half-speed, press Control+Shift+Spacebar (Windows) or Command+Shift+Spacebar (Macintosh). For details, see “Half-Speed Recording and Playback” on page 174.*

---

## Record Pause Mode

When recording a large number of tracks or channels, or playing back a large number of tracks while recording, Pro Tools may take a little longer to begin recording. To avoid this delay, put Pro Tools in Record Pause mode before beginning to record.

### To record from Record Pause mode:

- 1 Click Record in the Transport window. The Record button flashes.
- 2 Alt-click (Windows) or Option-click (Macintosh) Play in the Transport window to put Pro Tools in Record Pause mode. The Play and Record buttons flash.
- 3 To begin recording instantaneously, click Play. When you have finished recording, click Stop in the Transport window.

 *Use Pause mode when recording or playing large numbers of tracks to speed up lock-up time when synchronizing to time code.*

---

## Recording Additional Takes

After recording to an audio track, you can record additional takes to the same track. However, if you record these additional takes in Destructive Record mode, the audio residing on your hard drive from the previous takes will be permanently lost.

To keep the audio from previous takes, record the new takes nondestructively in Nondestructive Record mode.

 *For details on audio file and region names for new takes, see “Default Track Names” on page 144.*

### To nondestructively record a new take on the same track:

- 1 Put Pro Tools in Nondestructive Record mode. In the Operations menu, deselect Destructive Record, Loop Record, QuickPunch or Track-Punch if selected.
- 2 Make sure the track containing the previous take is still record enabled.

**3** To record from the beginning of the track, click Return to Zero in the Transport window.

– or –

If Operations > Link Edit and Timeline Selection is enabled, click anywhere in the track's playlist to begin recording from that point.

 To record a specific track range, with precise start and end points, see "Punch Recording Audio" on page 163.

**4** Click Record in the Transport window. When you are ready to begin recording, click Play.

**5** When you have finished recording, click Stop in the Transport window.

An audio file for the new take is written to disk and appears as an audio region in the track's playlist. The new audio region appears in the Audio Regions List.

The audio from the original take remains on your hard drive, and is still available as a region in the Audio Regions List.

#### **To destructively record over a previous take:**

**1** Select Operations > Destructive Record. When using Destructive Record mode, a "D" appears in the Record button.



*Destructive Record mode enabled*

**2** Make sure the track containing the previous take is still record enabled.

If Operations > Link Edit and Timeline Selection is enabled, click anywhere in the track's playlist to begin recording from that point.

**3** To record from the beginning of the track, click Return to Zero in the Transport window.

– or –

If Operations > Link Edit and Timeline Selection is enabled, click anywhere in the track's playlist to begin recording from that point.

 To record a specific track range, with precise start and end points, see "Punch Recording Audio" on page 163.

**4** Click Record in the Transport window. When you are ready to begin recording, click Play.

**5** When you have finished recording, click Stop in the Transport window.

The audio for the new take is written to disk, permanently overwriting the original. The new material replaces the original material within the existing region and the region is not re-named.

## **Appending New Material to the End of a Track**

You can also append new material to the end of a track. To do this, locate to the end of the track with the Go to End button in the Transport window (this will locate the end of the session), or tab to the end point of the last region on the track. From there, begin recording and Pro Tools will add the new material to the end of the track. If using Destructive Record mode, the new audio is appended to the audio file and region from the first take. In Nondestructive Record mode, a new file and region are created.

## Recording to a New Playlist

Instead of recording over existing audio regions, there is another way to nondestructively record new takes to the same track. Do this by creating a new playlist for the track, then record just as before.

Tracks can have multiple edit playlists, each of which stores a list of regions strung together in a particular order. Also, since playlists follow groups, duplicating or selecting alternate playlists for a track in a focused group will affect all tracks in the group.

### To record to a new playlist for a track:

**1** From the track's Playlist Selector pop-up, choose New. Enter a name for the new playlist and click OK.

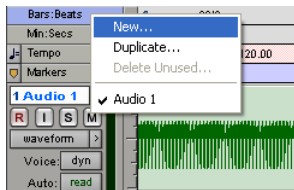

### Playlist Selector

When a new playlist is created, its name replaces the track name. With this playlist active, names for new audio files and regions are based on its name.

- 2** Make sure the track is still record enabled.
- 3** In the Transport window, click Return to Zero.
- 4** Click Record in the Transport window. When you are ready to begin recording, click Play.
- 5** When you have finished recording, click Stop in the Transport window.

An audio file for the new take is written to disk and appears as an audio region in the track's playlist. The new audio region appears in the Audio Regions List.

**6** To audition the new take, click Play in the Transport window.

**7** To go back to a previous playlist to compare it to the new take, select the playlist from the track's Playlist Selector.

Selecting a playlist recalls its regions as they previously appeared in the track. At any time, all regions from all playlists are available in the Regions List, and can be mixed and matched between playlists and tracks.

 For more information on playlists and playlist editing, see "Playlists" on page 217.

---

## Punch Recording Audio

To define a record range in the playlist, or replace a portion of a recorded track, you can *punch in* by specifying the record range before recording.

 To manually punch in and out on record-enabled audio tracks during playback, refer to "QuickPunch Audio Recording" on page 191, or "TrackPunch Audio Recording" on page 194.

Though there are several ways to set record and play ranges (see "Setting Punch/Loop Points" on page 168), perhaps the easiest is to select within the track's playlist the range for recording.

 To set a record or play range by selecting within a playlist, the Edit and Timeline selections must be linked (select Operations > Link Edit and Timeline Selection).

During the recording process, playback begins at the pre-roll time (if enabled) and proceeds to the start time (the punch-in point), where recording begins. When the end time (the punch-out point) is reached, Pro Tools automatically switches out of Record mode and continues playing through the specified amount of post-roll. This automated punch-in/out feature is a powerful and precise way of recording or re-recording a portion of a track.

### To punch record on an audio track:

**1** To record nondestructively, make sure that Operations > Destructive Record is not selected.

– or –

If you *do* want to permanently record over the specified record range, select Operations > Destructive Record.



*If you are recording in any mode other than Destructive Record mode, punches do not permanently replace the previously recorded material. If you do want to permanently record over the specified record range (and keep only the last, or most recent take), select Operations > Destructive Record.*

**2** Make sure the track to which you want to record is record enabled.

**3** Make sure to select Operations > Link Edit and Timeline Selection.

**4** With the Selector, drag in the track's playlist until the selection encompasses the punch range. For other methods of setting the record range, see "Setting Punch/Loop Points" on page 168.

**5** To hear any existing track material up to the start point, or after the end point, enable and set pre- and post-roll times. For details, see "Setting Pre- and Post-Roll" on page 170.

**6** Click Record in the Transport window. When you are ready to begin recording, click Play.

When the punch-in (start) point is reached, Pro Tools begins recording. Recording continues until the punch-out (end) point is reached, unless Stop is clicked in the Transport window. If post-roll is enabled, playback continues for the specified post-roll amount.

If recording nondestructively, a new audio file is written to your hard drive and a new audio region appears in the record track and Audio Regions List.

If recording in Destructive Record mode, the new audio overwrites the previous material in the existing audio file and region.

## Monitoring During Punch-Ins

Pro Tools provides two monitoring modes for recording: Auto Input monitoring and Input Only monitoring. For details, see "Auto Input Monitoring" on page 140.

---

## Loop Recording Audio

Pro Tools provides a loop recording feature that allows you to record take after take while the same section of audio repeats over and over. This is a convenient technique for quickly recording multiple takes of a part without losing spontaneity.

When loop recording, you must first specify the start and end points for the loop. Though there are several ways to set record and play ranges (see “Setting Punch/Loop Points” on page 168), perhaps the easiest is to select within the track’s playlist the material to be looped.

 *To set a record or play range by selecting within a playlist, the Edit and Timeline selections must be linked (select Operations > Link Edit and Timeline Selection).*

You can listen to track material up to and after the loop record range by enabling pre- and post-roll.

The pre-roll setting, if enabled, is used only during the first record pass, and the post-roll setting, if enabled, is used only on the last pass. Pre- and post-roll times are ignored on each successive loop. To compensate for this, you may want to make the loop range slightly longer. Later, you can trim back the recorded takes to the proper length with the Trimmer tool (see “The Trimmer Tool” on page 267).

When loop recording audio, Pro Tools creates a single audio file that comprises all takes. Takes appear as individual regions in the Audio Regions List and are numbered sequentially. Once you stop recording, you can audition any of the recorded takes.

### To loop record an audio track:

**1** Select Operations > Loop Record. When Loop Record mode is enabled, a loop symbol appears in the Record button.



*Loop Recording enabled*

**2** Record enable the audio track by clicking its Record Enable button.

**3** Make sure to select Operations > Link Edit and Timeline Selection.

**4** With the Selector, drag in the track’s playlist until the selection encompasses the loop range.

For other methods of setting the record range, see “Setting Punch/Loop Points” on page 168.

**5** To hear track material up to the start point of the loop, enable and set the pre-roll time. For details, see “Setting Pre- and Post-Roll” on page 170.

**6** Click Record in the Transport window. When you are ready to begin recording, click Play.

The Record button flashes during the pre-roll. When the start point is reached, Pro Tools begins recording. When the end point is reached, Pro Tools loops back to the start time and continues playing and recording.

**7** To cancel all recorded takes while loop recording, press Control+period (Windows) or Command+period (Macintosh).

**8** When you have finished recording, click Stop in the Transport window.

If you stop recording before you reach the midpoint of the loop, Pro Tools discards that take. If you record more than half of the looped take, Pro Tools will leave the take in the track when you stop recording.

The recorded takes appear as regions in the Audio Regions List and are numbered sequentially. The most recently recorded take is left in the record track. For details on auditioning the various takes, see “Auditioning Record Takes” on page 166.

## Loop Playback and Audio Recording

Pro Tools ignores “loop playback” when recording. The only way to loop while recording is to enable Loop Record mode.

---

## Auditioning Record Takes

After recording multiple takes with loop or punch recording, you can replace the take currently residing in the track with previous takes to audition them. (Takes must have the same start time to be available.) Takes can also be auditioned from the Regions List, or from the Takes List pop-up menu.

All takes are numbered sequentially.

## Auditioning from the Regions List

### To select a take from the Regions List:

- 1 In the Edit window, select the current take with the Grabber.
- 2 Control-drag (Windows) or Command-drag (Macintosh) another take from the Audio Regions List into the playlist.

The region replaces the previous take and snaps precisely to the correct location.

- 3 Repeat the above steps to audition other takes.

## Auditioning from the Takes List Pop-up Menu

Each region resulting from a punch or loop record pass has an identical start time (the *User Time Stamp*). This allows you to easily select and audition takes from the Takes List pop-up menu—even while the session plays or loops.

### To select a take from the Takes List pop-up:

- 1 Control-click (Windows) or Command-click (Macintosh) with the Selector at the precise beginning of the loop or punch range.

– OR –

If the take currently residing in the track is selected, Control-click (Windows) or Command-click (Macintosh) it with the Selector.

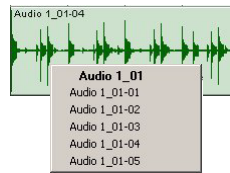

### Takes List pop-up

A pop-up menu appears containing a list of regions that share the same User Time Stamp.

- 2 Choose a region from the Takes List pop-up menu. The region replaces the previous take and snaps precisely to the correct location.
- 3 Repeat the above steps to audition other takes.

One way to ensure that future takes have the same *User Time Stamp* (and appear in the Takes List pop-up) is to store punch and loop record selections as Memory Locations. Then if you later need to record additional takes, simply recall the Memory Location. For more information, see “Memory Locations” on page 169.

To change the User Time Stamp of other regions so that they appear in the Takes List pop-up for a certain location, use the Time Stamp Selected command in the Regions List pop-up menu. For more information, see “Time Stamping” on page 570.

## Takes List and Multiple Tracks

If you have recorded multiple tracks, and each contains takes with identical User Time Stamps, you can use the Takes List pop-up menu to replace all takes simultaneously.

### To replace the takes for multiple tracks:

- 1 Choose Setups > Preferences, click the Editing tab, and enable the following options:
  - Take Region Name(s) That Match Track Names
  - Take Regions Lengths That Match
- 2 Click Done to close the Preferences dialog.
- 3 With the Selector, select the take range for each track you want to replace.
- 4 Control-click (Windows) or Command-click (Macintosh) any of the select takes with the Selector.

A pop-up menu appears containing a list of regions that share the same User Time Stamp for that track.

- 5 Choose a region from the Takes List pop-up menu. The region replaces the previous take and snaps precisely to the correct location. The same take numbers for the other selected tracks are also automatically selected.

## Editing Preferences for Takes

In addition to having the same User Time Stamp, regions that appear in the Takes List pop-up are also restricted according to options in the Preferences dialog.

### To set editing preferences for takes:

- Choose Setups > Preferences, click the Editing tab, and enable or disable the following options in the “Matching Start Time” Take List section:

#### Take Region Name(s) That Match Track

**Names** When selected, only regions that share the same root name with the track/playlist appear in the Takes List pop-up menu. For example, the Takes List for a track named “Gtr.L” would show the regions “Gtr.L\_01” and “Gtr.L\_02-01,” but not “Guitar.L\_01.”

#### Take Region Lengths That Match

When selected, only regions that match the length of the *current selection* (even if it is not an entire region) appear in the Takes List pop-up menu. If there is no selection, all takes with the same User Time Stamp are displayed.

#### “Separate Region” Operates On All Related

**Takes** When selected, editing a region with the Separate Region command also affects all other related takes with the same User Time Stamp.

This option helps you compare different sections from a group of related takes. For example, you can quickly separate an entire group of related vocal takes into sections, then audition and select the best material from each section independently.

If this option is selected, make sure the “Take Region Names That Match Track Name(s)” and “Take Region Lengths That Match” options are also selected. If they are not, *all* regions in the session that have the same User Time Stamp will be affected.

In most instances, you'll want to deselect the "Separate Region Operates On All Related Takes" option, to prevent a large number of regions from being created when you use the Separate Region command.

## Setting Punch/Loop Points

The start and end points of a record range for punch and loop recording can be set by the following methods:

- Select a range in a track's playlist
- Select a range in a Timebase Ruler
- Drag the Playback Markers in the Ruler
- Enter start and end times in the Transport window
- Recall a Memory Location

### To set the record range in a track's playlist:

- 1 If you want to constrain the selection to the current grid value, set the Edit mode to Grid.
- 2 Make sure to select Operations > Link Edit and Timeline Selection.
- 3 With the Selector, drag in a track's playlist until the selection encompasses the record range.

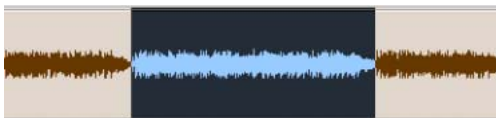

Playlist selection

– or –

If a region's start and end points define the record range, click the region with the Grabber.

 You can also enter start and end point during playback. Press the Down Arrow to set the start point, and press the Up Arrow to set the end point. Note that when in Grid mode, entering start and end point in this manner will not snap to the grid.

### To set the record range in a Timebase Ruler:

- 1 If you want to constrain the selection to the current grid value, set the Edit mode to Grid.
- 2 Drag with the Selector in any Timebase Ruler until the selection encompasses the record range.

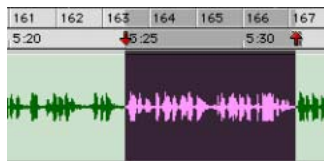

Timeline selection

 If the Selector is not active, you do not need to manually select it. Other Edit tools (such as the Grabber) automatically turn into the Selector when used in the Timebase Ruler.

## Playback Markers

When tracks are record enabled, Playback Markers for start and end times appear as red up/down arrows in the Ruler. If no tracks are record enabled, the Playback Markers are blue.

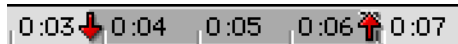

Playback Markers in Ruler

The Playback Markers can be moved, either separately or at the same time, to set record and play ranges.



### To set the record range by dragging the Playback Markers:

- 1 If you want the dragged Playback Markers to snap to the current grid value, set the Edit mode to Grid
- 2 Drag the first Playback Marker (down arrow) to the start point of the range.

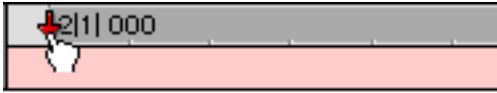

*Dragging a Playback Marker (start time) in Ruler*

- 3 Drag the second Playback Marker (up arrow) to the end point of the range.

 *If the current record range is already the right length and the range needs only to be moved, Alt-drag (Windows) or Option-drag (Macintosh) either Playback Marker to move both to a new location (while keeping the same length).*

### Start, End, and Length Fields

The Transport window can be resized to display start, end, and length times, and pre- and post-roll settings (choose Display Transport Window Shows > Expanded). When setting a record or play range, it is reflected in these fields.



*Transport window with Start, End, and Length fields displayed*

You can enter locations in the start and end fields to set the record or play range. The Playback Markers in the Ruler are updated accordingly.

### To set the record range by entering start and end times in the Transport window:

- 1 Select Display > Transport Shows > Expanded.
- 2 In the Transport window, click in the start field.

– or –

Press Alt+slash (Windows) or Option+slash (Macintosh) on the numeric keypad to select the start field in the Transport window.

- 3 Type in the start location and press slash on the numeric keypad to enter the value and automatically move to the end field.

- 4 Type in the end location and press Enter to accept the value.

 *Use the period (.) or Left/Right Arrow keys to move through the different time fields for start/end. Use the Up/Down Arrow keys to increase or decrease the numerical values.*

### Memory Locations

You can store Edit selections as Memory Locations, which can include current pre- and post-roll values.

For more information on Memory Locations, see “Memory Locations and Markers” on page 324.

### To save an Edit selection with a Memory Location:

- 1 Make sure to select Operations > Link Edit and Timeline Selection.
- 2 Set the record range by making a playlist or Ruler selection, or by entering start and end times in the Transport window.

3 To save the pre- and post-roll values, enable and set the pre- and post-roll amounts by entering them in the Transport window, or by dragging the Pre- and Post-Roll Flags in the Ruler. (For details, see “Setting Pre- and Post-Roll” on page 170.)

4 Press Enter on the numeric keypad.

5 In the New Memory Location dialog, set Time Properties to Selection, and if saving pre- and post-roll values, select the General Properties option for Pre/Post Roll Times.

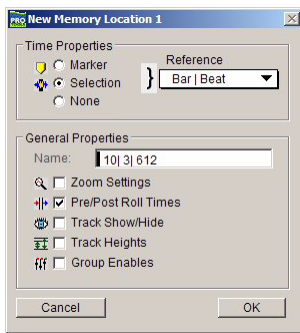

*New Memory Location dialog*

6 Enter a name for the new Memory Location and click OK to save it.

**To recall an Edit selection with a Memory Location:**

1 Make sure to select Operations > Link Edit and Timeline Selection.

2 Choose Windows > Show Memory Locations.



*Memory Locations window*

3 In the Memory Locations window, click the name or number of the Memory Location.

– OR –

Recall the Memory Location by typing period, the Memory Location number, and period again on the Numeric Keypad. (See “Numeric Keypad Modes” on page 31).

The start and end times and pre- and post-roll settings stored with the Memory Location are recalled.

**Setting Pre- and Post-Roll**

Pre- and post-roll times appear as flags in the Ruler. When pre- and post-roll are enabled, the flags are green, otherwise they are gray.



*Green Pre- and Post-Roll Flags (enabled) in the Ruler*

Pre- and post-roll amounts can be entered in the Transport window, set from a track’s playlist or Timebase Ruler, or by recalling a Memory Location.

## Setting Pre- and Post-Roll in the Transport Window

Pre- and post-roll can be enabled and set from the fields in the Transport window.

### To set and enable the pre- and post-roll times in the Transport window:

- 1 Select Display > Transport Shows > Expanded.
- 2 In the Transport window, click in the pre-roll field.
- 3 Type in the pre-roll amount and press slash on the numeric keypad to enter the value and automatically move to the post-roll field.
- 4 Type in the post-roll amount and press Enter to accept the new value.
- 5 To enable either pre- or post-roll, click the appropriate button so it becomes highlighted.



*Use the period (.) or Left/Right Arrow keys to move through the different time fields for pre and post-roll. Use the Up/Down Arrow keys to increase or decrease the numerical values.*

## Setting Pre- and Post-Roll in a Playlist

You can use the Selector to enable and disable pre- and post-roll by clicking in a track's playlist.

### To set and enable the pre- and post-roll by clicking in a playlist:

- 1 Make sure that Operations > Link Edit and Timeline Selection is enabled.
- 2 With the Selector, drag in the track's playlist until the selection encompasses the record range.
- 3 With the Selector, Alt-click (Windows) or Option-click (Macintosh) in the track's playlist before the selection to enable the pre-roll at that location.

4 With the Selector, Alt-click (Windows) or Option-click (Macintosh) in the track's playlist after the selection to enable the post-roll at that location.

### To disable the pre- and post-roll by clicking in a playlist:

- 1 With the Selector, Alt-click (Windows) or Option-click (Macintosh) within a track selection near the start to disable the pre-roll.
- 2 With the Selector, Alt-click (Windows) or Option-click (Macintosh) within a track selection near the end to disable the pre-roll.



*In the timeline, you can reset the pre- and post-roll to zero. First, drag the Pre-Roll Flag to the Playback Marker at the start point of the range, then drag the Post-Roll Flag to the Playback Marker at the end point of the range*

- 3 Drag the Pre-Roll Flag to the Playback Marker at the start point of the range.
- 4 Drag the Post-Roll Flag to the Playback Marker at the end point of the range.

## Enabling Pre- and Post-Roll from the Operations Menu

Pre- and post-roll (as a pair) can be enabled and disabled from the Operations menu.

### To enable both pre- and post-roll from the Operations menu:

- Select Operations > Pre/Post Roll Playback.

## Dragging Pre- and Post-Roll Flags in the Timebase Ruler

The Pre- and Post-Roll Flags can be moved in the Ruler, either separately or at the same time, to set their location.

### To set the pre- and post-roll amounts by dragging in the Ruler:

- 1 If you want the dragged flags to snap to the current grid value, set the Edit mode to Grid.
- 2 Drag the Pre-Roll Flag to a location in the Ruler.



Dragging a Pre-Roll Flag in Ruler

- 3 Drag the Post-Roll Flag to a location in the Ruler.

 To set pre- and post-roll values to the same amount, Alt-drag (Windows) or Option-drag (Macintosh) either the Pre- or the Post-Roll Flag in the Ruler. The deselected flag will immediately reset to the same value, and will adjust accordingly as you drag the selected flag.

## Recording from a Digital Source

If you plan to use a DAT player, digital-output CD recorder, or other digital input and output device with your Pro Tools system, make sure it supports the correct digital format. For example, your interface's AES/EBU inputs and outputs should only be connected to another AES/EBU device.

### Pro Tools|HD Systems

The 192 I/O, 192 Digital I/O, and 96 I/O include AES/EBU, S/PDIF, and ADAT digital options. Additionally, the 192 I/O and 192 Digital I/O include TDIF digital I/O options. The 96i I/O includes only the S/PDIF digital option.

On a 192 I/O, 192 Digital I/O, or 96 I/O, Pro Tools can receive digital audio from the factory-installed Optical (ADAT) I/O at any time (if it is not set to S/PDIF). However, Pro Tools can only receive digital audio from one of its enclosure [Encl] digital sources—AES, S/PDIF or Optical (S/PDIF) at a time.

Enclosure digital sources come standard with HD I/Os and are labelled on-screen as [Encl] versions, to differentiate them from digital inputs and outputs available on the 192's Digital I/O card. For example, the AES/EBU inputs and outputs that come standard in the 192 I/O enclosure are identified as AES/EBU [Encl].

The additional digital ports on the 192 I/O and 192 Digital I/O are TDIF, AES/EBU, and ADAT. Pro Tools can only receive digital audio from one of these ports at a time.

However, inputs on both the 192 I/O enclosure I/O and Digital card can be used simultaneously. For example, on a 192 I/O, it is possible to clock off a source from one of the enclosure inputs and have another digital input from the digital ports doing a sample rate conversion, thus having two digital sources.

### Pro Tools|24 MIX Systems

On the 888|24 I/O, 24-bit ADAT Bridge I/O, and the original ADAT Bridge I/O, both AES/EBU and S/PDIF outputs are active at all times, so you can actually send digital audio to two different digital devices simultaneously at mix time. However, Pro Tools can only receive digital audio from one digital source (AES or S/PDIF) at a time.

In addition, although the 888|24 I/O has four stereo AES input pairs, only input pair 1–2 on the master audio interface, (the first audio interface connected to your main DSP card), can accept an external digital clock source.

## Pro Tools LE Systems

The Digi 002, Digi 002 Rack, and Digi 001 include S/PDIF and ADAT digital options.

The Mbox includes only the S/PDIF digital option.

All digital outputs are active at all times, so you can actually send digital audio to different digital devices simultaneously at mix time.

## Recording from Digital Sources

**To record from a digital source with Pro Tools (in this example, from a DAT recorder):**

- 1 Connect the digital output of the DAT recorder to the appropriate digital input of your audio hardware.
- 2 If you want to start a new session with a different sample rate, choose File > New Session, and select the sample rate. Click Save.
- 3 Make sure to specify the format (digital) of the inputs of the audio interface you will be using. Choose Setups > Hardware Setup, choose the audio interface, and select the format for the appropriate channel pair. Some Digidesign I/O units, such as Digi 001, only have two channels (Ch 1–2) that can be set for analog or digital. Also, if your audio hardware supports different digital formats (such as AES/EBU and S/PDIF), select the digital format you will use.
- 4 For HD systems, choose Setups > Hardware Setup and select the appropriate Clock Source connected to the appropriate I/O audio interface; or use the Session Setup window to select the appropriate Clock Source.
- 5 Click OK to close the Hardware Setup dialog.
- 6 Choose File > New Track and specify 1 Stereo Audio Track, then click Create.

7 Assign the Input Selectors for the track to the appropriate inputs. Since this is a digital-to-main transfer, you don't need to worry about input levels.

8 In the Mix window, click the track's Output Selector and assign a stereo hardware output.

– or –

In the Edit window, with I/O view enabled, use the track's Output Selector to assign a hardware output.

9 In the Operations menu, deselect Destructive Record, Loop Record, QuickPunch and Track-Punch.

10 In the Transport window, click Return to Zero so the start and end times are cleared. This ensures that you'll start recording from the beginning of the track.

11 In the Mix or Edit window, record enable the new audio track by clicking its Record Enable button.

12 Click Record in the Transport window. When you are ready to begin recording, click Play.

13 Start playback on the DAT deck.

14 When the material from the DAT has finished, click Stop in the Transport window.

 *For more information on configuring your particular Pro Tools system for recording from a digital source, see your Getting Started Guide.*

## After a Digital Transfer

After you have finished recording digitally, set the Clock Source pop-up menu in the Session Setup window back to Internal. Otherwise, Pro Tools will not switch back to its own internal clock and will not record or play audio properly. Failure to switch back to Internal sync typically results in pitch problems (fast or slow

playback) or DAE errors, since a DAT recorder or CD Recorder that is idle can default to a different sample rate or stop outputting a sample rate clock altogether.

---

## Half-Speed Recording and Playback

Pro Tools lets you play and record at half-speed. This capability is similar to that of a tape deck where you can record material at half-speed and then play it back at normal speed (up an octave) for special effects.

### To record at half-speed:

- 1 Press Shift+Control+Spacebar (Windows) or Shift+Command+Spacebar (Macintosh). Recording begins and all existing track material plays at half-speed.
- 2 When you have finished recording, click Stop.

When played at normal speed, the material recorded at half-speed plays twice as fast (up an octave).

 *Use half-speed recording to record difficult to play MIDI tracks or to record complex automation moves.*

### To play at half-speed

1 Press Shift+Spacebar. Playback begins and track material plays at half-speed. Any audio tracks recorded at normal speed will sound half as fast and an octave lower, and any audio tracks playing back that were recorded at half-speed will sound like they are playing back at normal speed.

 *You can also play at half-speed by Shift-clicking the Play button.*

2 Click Stop in the Transport window to stop playback.

 *Use half-speed playback to learn or transcribe difficult passages in recorded tracks.*

# Chapter 13: MIDI Recording

Although recording MIDI in Pro Tools is similar to recording audio, there are some important differences:

- ◆ Unlike audio, MIDI recording is almost always destructive. See “The Record Modes and MIDI” on page 150 for details.
- ◆ Unlike audio tracks, MIDI tracks can be record enabled on-the-fly during playback or recording.
- ◆ Similar to audio tracks, MIDI tracks have an Input Selector that determines which ports on your MIDI interface (devices) and which MIDI channels are routed and recorded to the track. If the Input Selector is set to All, all channels for all devices are routed to the track.
- ◆ It is not necessary to use QuickPunch or TrackPunch to punch in on-the-fly with MIDI tracks. This capability is available in normal Nondestructive Record mode, and in Destructive Record mode.
- ◆ MIDI tracks are not automatically delay compensated when using Delay Compensation. Delay Compensation corrects audio track latency only. For more information, see “Delay Compensation” on page 428.

---

## Recording from MIDI Devices

The MIDI Inputs for record-enabled MIDI tracks determine which MIDI data is recorded in Pro Tools. MIDI Inputs can be set to a specific device (port) and channel, or they can be set to “All,” where all channels for all devices are merged to the track.

MIDI tracks in Pro Tools do not contain multiple channels and always play back on the track’s assigned (MIDI output) devices and channels. Multiple MIDI channels can be simultaneously recorded to multiple tracks.

The following Pro Tools options determine whether you can record from a MIDI controller device:

- ◆ Devices that are assigned as a MIDI Controller in the Peripherals dialog are ignored when MIDI tracks are recorded. This is to avoid recording data from MIDI control surfaces (such as the Digidesign Command|8).
- ◆ To record and play MIDI, the device must be enabled in the Input Devices dialog (Macintosh Only). For more information, see “Enabling Input Devices” on page 176.

In addition, the following options affect how MIDI data is recorded in Pro Tools.

- ◆ The MIDI Input Filter can filter out MIDI messages that you may not want to record, such as Polyphonic Aftertouch or System Exclusive data. For more information, see “MIDI Input Filter” on page 178.
- ◆ Input Quantize, when enabled, automatically quantizes (time corrects) all MIDI notes that are recorded. For more information, see “Input Quantize” on page 178.

---

## Enabling Input Devices

### (Macintosh Only)

To record from a MIDI controller in Pro Tools, the device must be enabled in the Input Devices dialog. You can also use this dialog to make sure unwanted notes from certain devices, such as drum machines or arpeggiators, are not recorded.

**MIDI Control Surfaces** ◆ In order to use any MIDI control surfaces (such as the Digidesign Command8), they must be enabled in the Input Devices dialog.

**MMC** In order for Pro Tools to sync to MMC, the MMC source must be enabled in the Input Devices dialog.

### To enable input devices:

- 1 Choose MIDI > Input Devices.
- 2 In the MIDI Input Enable dialog, select the MIDI devices you will record from. Also, make sure any devices that will be used as a control surface are also selected.

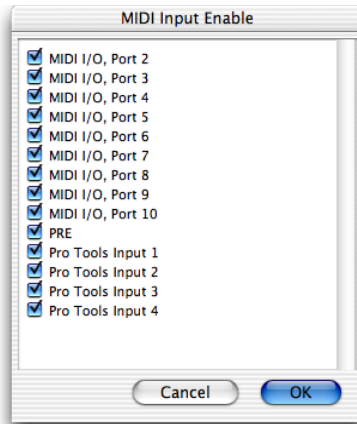

*MIDI Input Enable dialog*

- 3 Deselect any devices you want to ignore while recording MIDI.
- 4 When you are finished, click OK.

### Pro Tools Inputs (Mac OS X Only)

Pro Tools has four virtual MIDI inputs, called Pro Tools Inputs, that can receive MIDI from other supported software applications. For example, you can use Pro Tools Inputs to synchro-



nize to MIDI Time Code generated from another supported software application, or record MIDI data from another MIDI sequencer to Pro Tools MIDI tracks.

 *MIDI Patchbay is a useful application for routing MIDI between applications that support virtual MIDI inputs (such as Pro Tools), and applications that don't (such as Reason). For more information, see <http://pete.yandell.com/software>.*

---

## MIDI Thru

To monitor MIDI tracks while recording, enable MIDI Thru. When enabled, Pro Tools routes MIDI from your controllers to the device and channels assigned to the MIDI track currently record enabled.

 *The MIDI Preference for Global MIDI Playback Offset and individual MIDI track offsets do not affect MIDI routed with MIDI Thru.*

 *When MIDI Thru is enabled, System Exclusive events are echoed to the MIDI device assigned to the record-enabled track—but only if the Sysex events are smaller than 256 bytes.*

### To enable MIDI Thru:

- Select MIDI > MIDI Thru.

 *When using MIDI Thru, you should disable Local Control, if present, on your MIDI devices. Otherwise, your MIDI device may receive double MIDI notes, which can lead to stuck notes. If you are unsure how to disable Local Control for your instrument, refer to the manufacturer's documentation.*

## The Default Thru Instrument

In addition to any MIDI tracks that are record enabled, you can also route MIDI to the Default Thru Instrument. This saves you the trouble of creating a MIDI track and record enabling it to hear a particular MIDI device and channel.

Unlike MIDI tracks, which only listen to the device and channel assigned to its Input Selector, all incoming MIDI data is routed to the Default Thru Instrument.

If the Default Thru Instrument is assigned to a record-enabled MIDI track, Pro Tools only routes to the record-enabled track.

### To set the Default Thru Instrument:

- 1 Choose Setups > Preferences, and click the MIDI tab.
- 2 From the pop-up menu for Default Thru Instrument, select the MIDI device and channel to which MIDI data will be routed. To disable the Default Thru Instrument, select None.

## MIDI Input Filter

Use the MIDI Input Filter to prevent certain MIDI messages from being recorded. The MIDI Input Filter can be set to record “All” messages, “Only” the specified messages, or “All Except” the specified messages.

**For example, to filter out Polyphonic Aftertouch:**

- 1 Choose MIDI > Input Filter.
- 2 In the MIDI Input Filter dialog, select the All Except option.

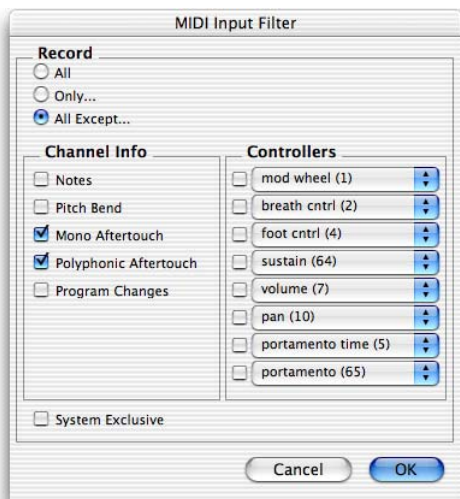

### MIDI Input Filter

- 3 Select the option for Polyphonic Aftertouch. Leave all other messages deselected.
- 4 Click OK.

When using the All Except option, the selected MIDI messages will not be recorded. Conversely, when using the Only option, only the MIDI messages that are selected will be recorded.

## Input Quantize

When Input Quantize is enabled, all recorded MIDI notes are quantized automatically. To preserve the original “feel” of your recorded MIDI tracks, make sure to disable this option.

**To enable Input Quantize:**

- 1 Choose MIDI > Input Quantize.
- 2 In the Input Quantize window, select the Enable Input Quantize option.

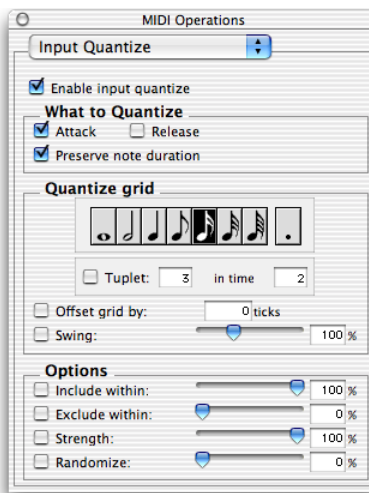

### Input Quantize window

Configure the other options in the Input Quantize window. For details on the various Quantize options, see “Quantize” on page 380. When finished, close the Input Quantize window.

For *drum machine* style loop recording, use Input Quantize while loop recording MIDI in Merge mode (see “Loop Recording with Merge Mode” on page 185).

## Wait for Note

The Wait for Note button, located in the Transport window, determines how Pro Tools begins recording. When enabled, Pro Tools will not begin recording until a MIDI event is received. This ensures that you begin recording when you're ready to play, and that the first note, or other MIDI data, is recorded precisely at the beginning of the record range (start time).

Wait for Note can be used when recording normally, when punching in, or when loop recording. If pre-roll is enabled, it occurs after the MIDI event is received and before recording begins.

### To enable Wait for Note:

- 1 To view the MIDI controls in the Transport window, select Display > Transport Window Shows > MIDI Controls.



Transport window with MIDI Controls

- 2 In the Transport window, click the Wait for Note button so it becomes highlighted.



Wait for Note enabled

 With the Operation Preference for “Use F11 for Wait for Note” enabled, you can press F11 to turn on Wait for Note.

## MIDI Merge/Replace

The MIDI Merge button, located in the Transport window, determines how MIDI is recorded when overdubbing or punching in. When MIDI Merge is on (*Merge mode*), recorded MIDI is merged with existing track material. When MIDI Merge is off (*Replace mode*), existing data within the punched region is replaced by the newly recorded material.

The MIDI Merge button can be turned on and off while playing or recording. In Loop Record mode, MIDI Merge has no effect, so its button is dimmed.

 To enable MIDI Merge with a keyboard shortcut, set the Numeric Keypad Mode to Transport, and press the 9 key on the numeric keypad.

### To enable MIDI Merge:

- 1 To view the MIDI controls in the Transport window, select Display > Transport Window Shows > MIDI Controls.
- 2 In the Transport window, click the MIDI Merge button so it becomes highlighted.



MIDI Merge enabled

## Configuring MIDI Tracks for Recording

To configure one or more MIDI tracks for recording:

1 If you do not have a MIDI track to record to, choose File > New Track and specify 1 MIDI Track, then click Create.

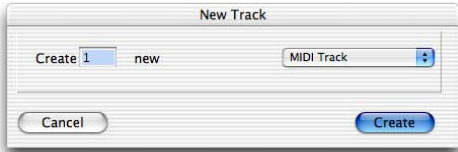

*New Track dialog*

2 Rename the MIDI track. Track names are used to auto-name recorded regions. For more information, see “Default Track Names” on page 144.

3 In the Mix window, click the track’s MIDI Input Selector and assign the device and channel to be recorded.

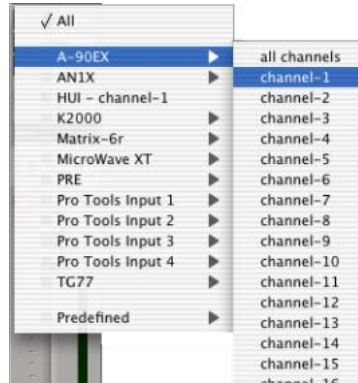

*MIDI Input Selector, Mix window*

– or –

In the Edit window, with I/O view enabled, click the track’s MIDI Input Selector and assign the device and channel to be recorded.

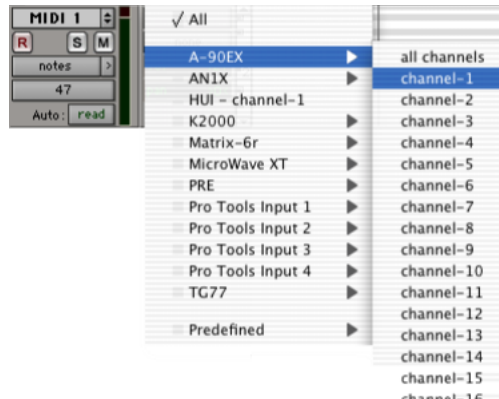

*MIDI Input Selector, Edit window*

4 In the Mix window, click the track's MIDI Output Selector and assign a device and channel from the pop-up menu. Channels already assigned to other tracks appear bold in this menu.

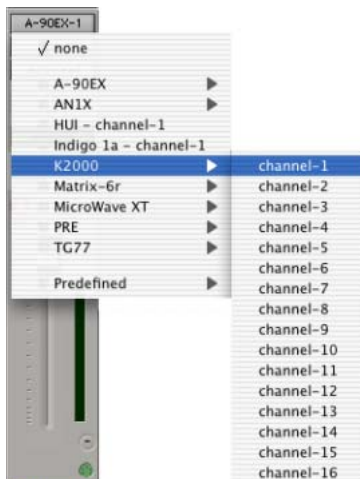

MIDI Output Selector, Mix window

– or –

In the Edit window, with I/O view enabled, click the track's MIDI Output Selector and assign a device and channel from the pop-up menu. Channels already assigned to other tracks appear bold in this menu.

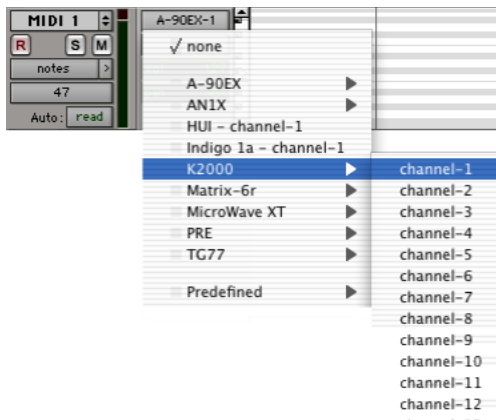

MIDI Output Selector, Edit window

5 To assign multiple destinations to a single MIDI track, Start-click (Windows) or Control-click (Macintosh) the MIDI Output Selector and select additional channels from any device. When multiple destinations are selected for a single MIDI track, a “\*” sign will appear next to the first destination name in the track's MIDI Output Selector on Windows and Mac OS X, and a “+” sign will appear next to the first destination name in the track's MIDI Output Selector on Mac OS 9.

6 If you want to assign a default program change to the track, click the Patch Select button, make the necessary selections for program and bank select, then click Done.

Default program changes are sent whenever the track is played. For more information, see “Patch Select (Program and Bank Changes)” on page 366.

7 If recording to multiple MIDI tracks, repeat the above steps for each track, then continue to the next step.

8 If you want to use a click, enable and configure the click, and set a default tempo and meter for the session. For details, see “Recording with a Click” on page 151.

9 Enable Wait for Note or Countoff in the Transport window if you want to use these features.

10 To replace existing track material, disable MIDI Merge in the Transport window.

11 If you want to automatically quantize material as it is recorded, enable Input Quantize (see “Input Quantize” on page 178).

12 In the Transport window, click Return to Zero so the start and end times are cleared. This ensures that you'll start recording from the beginning of the track.

**13** In either the Mix or Edit window, click the MIDI track's Record Enable button to record enable the track.

**14** Make sure MIDI > MIDI Thru is selected, then play some notes on your MIDI controller. The MIDI instrument assigned to the track should sound, and the track's meters should register MIDI activity.

You are now ready to record MIDI data to the record-enabled MIDI tracks. See "Recording to MIDI Tracks" on page 182.

---

## Recording to MIDI Tracks

In Pro Tools, you can record to one or more MIDI tracks. Recording simultaneously to multiple MIDI tracks allows you to:

- Record from multiple MIDI devices at the same time, capturing material from several performers
- Record multiple channels from the same device, capturing data from a split keyboard
- Transfer MIDI tracks from an external MIDI sequencer

 *To take full advantage of the MIDI editing capabilities in Pro Tools, make sure to record with the click enabled. This ensures that recorded data aligns with the session's bar and beat boundaries.*

### To record to one or more MIDI tracks:

**1** For HD systems (using Pro Tools 6.4) deactivate Automatic Delay Compensation. (For more information, see "Delay Compensation" on page 428.)

**2** Configure a MIDI track for recording. Refer to "Configuring MIDI Tracks for Recording" on page 180.

**3** Record enable the MIDI track you want to record by clicking its Record Enable button.

 *Shift-click to toggle on record enable for multiple MIDI tracks.*

**4** Put Pro Tools in normal Nondestructive Record mode. In the Operations menu, deselect Destructive Record, Loop Record, and Quick-Punch.

**5** Click Record in the Transport window to enter Record Ready mode. The Record button flashes.



### Record button

**6** When you are ready to begin recording, click Play. If using Countoff, Pro Tools counts off the specified number of measures and then begins recording.

– or –

If using Wait for Note, the Play, Record, and Wait for Note buttons flash. Recording begins when a MIDI event is received.

**7** When you have finished recording, click Stop in the Transport window.

For each record-enabled track, a new MIDI region is created and appears in the playlist. The new MIDI regions also appear in the MIDI Regions List.

 *There are several keyboard shortcuts you can use to begin recording. See "Record Shortcuts" on page 161 for details.*

### To play back recorded MIDI tracks:

- 1 Click the Record Enable button on each MIDI track so that they are no longer record enabled.
- 2 In the Transport window, click Return to Zero.
- 3 Click Play in the Transport window to begin playback.

The recorded MIDI data plays back through each track's assigned device (port) and channel.

## Undo and MIDI Recording

You can undo previous MIDI record takes.

### To undo a MIDI recording:

- Once the Transport has been stopped, choose Edit > Undo MIDI Recording.

The track's playlist is restored to its previous state. However:

- ◆ If you punched in and out several times before stopping the Transport, only the last punch is undone.
- ◆ When using Loop Record mode, all takes from each record pass are discarded.

## Canceling a Record Take

It is also possible to discard the current record take *before* the Transport is stopped.

### To cancel a record take while recording:

- Press Control+period (Windows) or Command+period (Macintosh) before the Transport is stopped.

If using Loop Record mode, all takes from each record pass are discarded.

---

## Punch Recording MIDI

To replace a portion of a MIDI track, you can *punch in* by specifying the record range before recording.

### To punch in on a MIDI track:

- 1 Configure a MIDI track for recording. Refer to "Configuring MIDI Tracks for Recording" on page 180.
- 2 Put Pro Tools in normal Nondestructive Record mode. In the Operations menu, deselect Destructive Record, Loop Record, and Quick-Punch.
- 3 In the Transport window, disable Wait for Note and Countoff.
- 4 Select Operations > Link Edit and Timeline Selection.
- 5 With the Selector, drag in the track's playlist until the selection encompasses the punch range.

For other methods of setting the record range, see "Setting Punch/Loop Points" on page 168.

- 6 To hear existing track material up to the start point, or after the end point, enable and set pre- and post-roll times. For details, see "Setting Pre- and Post-Roll" on page 170.
- 7 Record enable the track containing the previous take by clicking its Record Enable button.
- 8 Click Record in the Transport window to enter Record Ready mode. The Record button flashes.
- 9 When you are ready to begin recording, click Play.

If pre-roll is enabled, the track material leading up to the punch-in point plays. You can start playing during the pre-roll to get the “feel.” Material is not recorded until the start point is reached.

When the start point is reached, Pro Tools begins recording. Recording continues until the end point is reached, unless Stop is clicked in the Transport window. If post-roll is enabled, playback continues for the specified post-roll amount.

**10** When you have finished recording, click Stop in the Transport window.

The newly recorded MIDI data appears in the track.

## **Punch Recording During Playback with MIDI**

You don’t have to set a record range to punch in on a MIDI track. In fact, you can punch in and out on-the-fly at any time during playback. Unlike audio tracks, it is not necessary to enable QuickPunch to perform real-time punch recording.

### **To punch record on-the-fly with MIDI:**

**1** Configure a MIDI track for recording. Refer to “Configuring MIDI Tracks for Recording” on page 180.

**2** Put Pro Tools in normal Nondestructive Record mode. In the Operations menu, deselect Destructive Record, Loop Record, and QuickPunch.

**3** In the Transport window, disable Wait for Note and Countoff.

**4** Record enable the track containing the previous take by clicking its Record Enable button.

**5** Start playback by clicking Play in the Transport window.

**6** When you reach the punch-in point, click Record in the Transport window.

– or –

For Digi 002, Digi 002 Rack, and Digi 001 systems (or Digidesign ProControl and Control|24 dedicated controllers) with a connected footswitch, press the footswitch at the punch-in point.

The Record button stops flashing and stays lit during recording.

**7** To punch out, click Record again (or press the footswitch).

Pro Tools exits Record mode and continues playing. You can perform additional punches during the same pass.



## Regions and Punch Recording

Depending on the record range, new regions may be created after punch recording. For example, Figure 7 shows two existing regions before recording. Since the start and end times occur within both of the existing regions, a new region is created to fill the space between them.

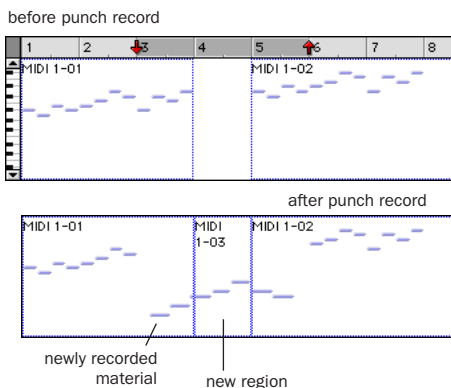

Figure 7. Region added after punch record

However, when selecting an entire region, or a section within a region, before punching, no new regions are created. In this instance, only the material residing within the existing region changes, with no new material recorded outside the region.

Unlike audio recording, MIDI recording in this scenario is destructive. If a region is altered because of a record take, the original material is lost (unless you choose Edit > Undo MIDI Recording), or combined with new material (if MIDI Merge was enabled during recording). If an existing region contains important material, use Duplicate to make a copy of the region (“Duplicate Command” on page 283) or the track’s playlist (see “Working with Playlists” on page 218).

## Loop Recording MIDI

Loop recording with MIDI is supported by two methods:

- In normal Nondestructive Record mode, enable Loop Playback and MIDI Merge for drum machine style loop recording.
  - or –
- Use Loop Record mode to record multiple takes on each record pass. This is similar to loop recording audio.

## Loop Recording with Merge Mode

For drum machine style loop recording, use normal Nondestructive Record mode with Loop Playback and MIDI Merge enabled. With this method, MIDI is recorded and merged to the same region with each new record pass—thereby allowing you to, for example, record hi-hats on the first pass and kick and snare on the next.

Make sure that MIDI Merge is enabled in the Transport window, otherwise (in Replace mode) each subsequent take will destructively replace the previous.

 You can record enable a different MIDI track on-the-fly while loop recording. While pressing Control (Windows) or Command (Macintosh), use the Up/Down Arrows to record enable the previous or next MIDI track.

### To loop record with MIDI Merge:

- 1 Configure a MIDI track for recording. Refer to “Configuring MIDI Tracks for Recording” on page 180.

**2** Put Pro Tools in normal Nondestructive Record mode. In the Operations menu, deselect Destructive Record, Loop Record, and Quick-Punch.

**3** Select Operations > Loop Playback. When Loop Playback is enabled, a loop symbol appears in the Play button.



*Loop Playback enabled*

**4** Record enable the MIDI track by clicking its Record Enable button. Make sure no audio tracks are record enabled.

**5** In the Transport window, click the MIDI Merge button so it becomes highlighted.

**6** Disable Wait for Note and Countoff in the Transport window.

**7** Select Operations > Link Edit and Timeline Selection.

**8** With the Selector, drag in the track's playlist until the selection encompasses the loop range.

For other methods of setting the record range, see "Setting Punch/Loop Points" on page 168.

**9** To hear track material up to the start point of the loop, enable and set the pre-roll time. For details, see "Setting Pre- and Post-Roll" on page 170.

**10** Click Record in the Transport window. When you are ready to begin recording, click Play.

The Record button flashes during the pre-roll. When the start point is reached, Pro Tools begins recording. When the end point is reached, Pro Tools loops back to the start point and continues playing and recording.

**11** Play some notes on your MIDI controller. Newly recorded MIDI data appears as a region in the record track. On each successive take, recorded material shows up in the region, without replacing material from previous takes.

**12** If you want to switch to a new record track, press Control (Windows) or Command (Macintosh), and press the Up/Down Arrow keys to record enable the previous or next MIDI track.

**13** When you have finished recording, click Stop in the Transport window.

The newly recorded MIDI data appears as a MIDI region in the track's playlist, and in the MIDI Regions List.

## Loop Recording Multiple Takes

When recording MIDI in Loop Record mode, new regions are created each time new material is received during a record pass. This differs somewhat from loop recording audio, where Pro Tools creates a single audio file that comprises all takes, which appear as individual regions in the Audio Regions List.

You can use MIDI loop recording to record successive takes without stopping the record process, thereby capturing your creative spontaneity. Another advantage with this method of recording MIDI, which is nondestructive, is that existing and newly recorded regions remain intact (and available in the MIDI Regions List).

### To record MIDI in Loop Record mode:

- 1 Configure a MIDI track for recording. Refer to “Configuring MIDI Tracks for Recording” on page 180.
- 2 Select Operations > Loop Record. When Loop Record mode is enabled, a loop symbol appears in the Record button.



### Loop Recording enabled

- 3 If you have not done so already, record enable the MIDI track by clicking its Record Enable button. Make sure no audio tracks are record enabled.
- 4 Disable Wait for Note and Countoff in the Transport window.
- 5 Select Operations > Link Edit and Timeline Selection.

- 6 With the Selector, drag in the track’s playlist until the selection encompasses the loop range.

For other methods of setting the record range, see “Setting Punch/Loop Points” on page 168.

- 7 To hear track material up to the start point of the loop, enable and set the pre-roll time. For details, see “Setting Pre- and Post-Roll” on page 170.

- 8 Click Record in the Transport window. When you are ready to begin recording, click Play.

The Record button flashes during the pre-roll. When the start point is reached, Pro Tools begins recording. When the end point is reached, Pro Tools loops back to the start point and continues playing and recording.

- 9 Play your MIDI controller. A new MIDI region containing the newly recorded material is automatically created and appears in the track’s playlist, replacing the previous region.

Regions are replaced (nondestructively) during subsequent record passes when new MIDI material is received.

- 10 When you have finished recording, click Stop in the Transport window. The most recently recorded take is left in the record track.

The recorded takes appear as regions in the MIDI Regions List and are numbered sequentially. The takes, which are the same length and easily interchangeable, can be auditioned from the Takes List pop-up menu—even while the session plays or loops.

### To audition the various record takes:

1 Control-click (Windows) or Command-click (Macintosh) with the Selector at the precise beginning of the loop record range.

– or –

If the take currently residing in the track is selected, Control-click (Windows) or Command-click (Macintosh) it with the Selector.

A pop-up menu appears containing a list of regions that share the same User Time Stamp.

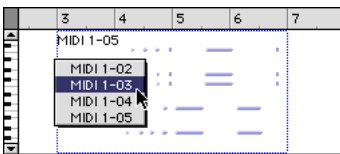

### Auditioning loop record takes

2 Choose a region from the Takes List pop-up menu. The region replaces the previous take and snaps precisely to the correct location.

For more information on auditioning and managing takes, see “Auditioning Record Takes” on page 166.

---

## Recording System Exclusive Data

Pro Tools supports recording and playing System Exclusive data (Sysex) with MIDI tracks. This allows you to use MIDI tracks in Pro Tools to store patch and configuration data for your MIDI devices, or to record real-time Sysex changes for a particular parameter of a MIDI device that cannot be controlled by a standard MIDI controller.

### To record a Sysex dump at the beginning of a MIDI track:

1 Make sure that the MIDI OUT for the device sending the Sysex is connected to your MIDI interface’s MIDI IN.

2 Configure a MIDI track for recording. Refer to “Configuring MIDI Tracks for Recording” on page 180.

3 Put Pro Tools in normal Nondestructive Record mode. In the Operations menu, deselect Destructive Record, Loop Record, and Quick-Punch.

4 In the MIDI Input Filter, enable recording of System Exclusive data.

5 If you have not done so already, record enable the MIDI track by clicking its Record Enable button.

6 Enable Wait for Note in the Transport window.

7 In the Transport window, click Return to Zero so the start and end times are cleared. This ensures that you’ll start recording from the beginning of the track.

8 When you are ready to begin recording, click Record in the Transport window.

The Record, Play, and Wait for Note buttons flash, indicating that Pro Tools is waiting for MIDI data.

**9** Initiate the Sysex transfer from the MIDI device, according to the instructions in the guide for your MIDI device. When receiving the MIDI data, Pro Tools automatically begins recording.

**10** When the transfer is complete (as defined in the guide for your MIDI device), click Stop in the Transport window.

The newly recorded MIDI data appears as a MIDI region in the track's playlist, and in the MIDI Regions List. MIDI regions that contain System Exclusive data appear blank when the track's Display Format is set to Regions.

To see the Sysex event blocks, which indicate the location of the data, set the MIDI Track View to display Sysex (see "Regions View for MIDI Tracks" on page 216). For details on moving and copying of Sysex data, see "System Exclusive Events" on page 369.

#### **To resend the Sysex from Pro Tools:**

- 1** For the device receiving the System Exclusive data, make sure its MIDI IN is connected to your MIDI interface's MIDI OUT. Also, make sure the device is set to receive Sysex. Some devices require that memory protect be off.
- 2** For the previously recorded track, click its Record Enable button so that it is no longer record enabled.
- 3** Click the track's MIDI Device/Channel Selector and assign the device from the pop-up menu.
- 4** In the Transport window, click Return to Zero.
- 5** Click Play in the Transport window to begin playback. Pro Tools begins playing and transmits the previously recorded Sysex to the assigned MIDI device.



# Chapter 14: Advanced Recording

There are two advanced recording methods that differ from basic recording, QuickPunch and TrackPunch.

**QuickPunch** A nondestructive recording mode that lets record enabled tracks be punched in and punched out during playback by clicking the Transport's Record button.

**TrackPunch (TDM only)** A nondestructive recording mode that lets individual tracks be punched in, punched out, and taken out of record enable without interrupting online recording and playback.

---

## QuickPunch Audio Recording

Pro Tools features an intelligent on-the-fly punch capability called QuickPunch. QuickPunch lets you instantaneously punch in and out on record-enabled audio tracks during playback by merely clicking the Record button in the Transport window.

 *For Digi 002, Digi 002 Rack, and Digi 001 systems, and Digidesign control surfaces, you can use a footswitch to punch in and out when recording with QuickPunch.*

When using QuickPunch, Pro Tools begins recording a new file when playback begins, automatically generating regions in that file at each punch-in and punch-out point. These regions appear in the track's playlist; and the complete audio file appears in the Regions List along with the QuickPunch created regions. Up to 200 of these "running punches" can be performed in a single pass. Unlike normal punch recording (see "Punch Recording Audio" on page 163), QuickPunch provides instantaneous monitor switching on punch-out. All QuickPunch recording is nondestructive.

 *You don't need to use QuickPunch to punch on-the-fly with MIDI tracks. This capability is available in normal Nondestructive Record mode, and in Destructive Record mode.*

## QuickPunch/TrackPunch Crossfade Length

Pro Tools can automatically write a crossfade for each punch point when using QuickPunch. The length for these crossfades is set with the QuickPunch Crossfade/TrackPunch Length option in the Editing Preferences.

### To set the QuickPunch Crossfade Length:

1 Choose Setups > Preferences, and select the Editing tab.

2 Enter a new value (in msec) for the QuickPunch /TrackPunch CrossFade Length.

A good general-purpose crossfade length for punches is 10 milliseconds. If you set the preference to zero, Pro Tools will not create any crossfades at the punch-in/out points.

3 Click Done.

If a value other than zero is specified for the QuickPunch/TrackPunch Crossfade Length, Pro Tools writes a pre-crossfade at the punch-in point (which occurs up to but not into the punched region boundary), and a post-crossfade at the punch-out point (which occurs after the punched region).

Even if the QuickPunch/TrackPunch Crossfade Length is set to zero, Pro Tools always executes a 4 millisecond “monitor only” crossfade (which is not written to disk) to avoid distracting pops or clicks that might occur as you enter and exit record mode.

QuickPunch crossfades can later be edited in the same manner as standard crossfades. For details, see “Using Crossfades” on page 295.

## QuickPunch Guidelines for TDM Systems

When using QuickPunch on TDM systems, two voices are required for each record-enabled, mono track. This means that you can record up to half the total number of voices available on your system. For example, a Pro Tools|HD system configured for 128 voices can simultaneously record on up to 64 mono tracks with QuickPunch (or 32 stereo tracks).

If the required number of voices for the record-enabled tracks is not available when switching to QuickPunch mode, you will be prompted to free up the necessary voices.

### To free up voices on tracks that are not record-enabled, and do not need to be heard while recording:

- Set voice assignments for tracks to Off.
  - or –
- Make tracks inactive.

As necessary, voices in use by other tracks, which are not record-enabled, may be “stolen” while recording with QuickPunch. Priority for tracks while recording with QuickPunch are as follows:

- Tracks with assigned voices that are not record-enabled
- Tracks with assigned voices that *are* record-enabled
- Auto-voiced tracks that are not record-enabled
- Auto-voiced tracks that *are* record-enabled

If the session has plenty of available voices, you may have no trouble using QuickPunch with auto-voiced tracks. However, if you are running out of voices, and want to ensure that a track will be heard when recording with QuickPunch, assign it a voice.

### QuickPunch and Auto Voice (TDM Systems Only)

When using QuickPunch with a Pro Tools TDM system configured for the maximum 128- or 64-voices, make sure to set the voice assignment for each audio track to Auto. This ensures that Pro Tools will automatically handle the distribution of voices between each set of voices. For



example, for a 128-voice configured Pro Tools|HD system, auto-voice distributes voices evenly across four sets of voices (1–32, 33–64, 65–96, and 96–128).

If you do not use auto-voicing, the voices must be evenly distributed between all DSP engines. For example, to use QuickPunch on 32 tracks without auto-voicing, tracks 1–16 must be assigned to voices 1–16 and tracks 17–32 must be assigned to voices 33–48.

## QuickPunch Guidelines for LE Systems

For LE systems, 16 audio tracks can be simultaneously recorded with QuickPunch in addition to the maximum number of mono tracks supported by your specific Pro Tools LE system (see “Pro Tools LE System Capabilities” on page 10).

To simultaneously record more tracks than this with QuickPunch, you’ll need to reduce the number of tracks in the session.

**⚠** *With Pro Tools LE, QuickPunch uses CPU processing power, and may reduce the number of tracks and plug-ins you can use.*

## Recording with QuickPunch

### To punch on-the-fly with QuickPunch:

**1** For HD systems (with Pro Tools 6.4), make sure that Use Delay Compensation is deselected in the Operations menu.

**⚠** *Digidesign recommends recording without Delay Compensation. For more information, see “Delay Compensation” on page 428.*

**2** Select Operations > QuickPunch. When QuickPunch is enabled, a “P” appears in the Record button.



*QuickPunch enabled*

**3** To change the automatic crossfade used by QuickPunch, configure QuickPunch Crossfade Length option in the Editing Preferences (see “QuickPunch/TrackPunch Crossfade Length” on page 191).

**4** Record enable the tracks you want to punch in on. Make sure there are enough available voices on your system.

**5** Prepare to record by cueing Pro Tools to an appropriate location. If you want to use pre-roll, enable a pre-roll value in the Transport window.

**6** Start playback by clicking Play in the Transport window.

**7** When you reach the punch-in point, click Record in the Transport window.

– or –

For Digi 002, Digi 002 Rack, or Digi 001 systems with a connected footswitch, press the footswitch at the punch-in point.

The Record button stops flashing and stays lit during recording.

**8** To punch out, click Record again (or press the footswitch).

As Pro Tools continues playing, you can perform additional punches (up to 100). When recording multiple punches during a single pass, a single audio file is recorded from which Pro Tools creates the appropriate regions.

## QuickPunch with an Edit Selection

If you make an Edit selection and use QuickPunch, the following rules apply:

- ◆ If the Transport is not online, recording begins and stops whenever you click the Record button—regardless of the selection’s start or end point.
- ◆ If the Transport is online, punch-in/out behavior is controlled by the Online Options setting in the Operations Preferences. If you select Record Online at Insertion/Selection, QuickPunch punches in and out only within the selection (or in the case of an insertion point, only after the insertion point). If you select Record Online at Time Code Lock, QuickPunch disregards the selection and punches in and out whenever you want (after Pro Tools has locked to time code).

## Region and Take Numbering with QuickPunch

After recording with QuickPunch, the new audio regions appear in the Audio Regions List. This includes the whole-file audio region encompassing all punches from the record pass, along with the regions derived for each punch.

Names for the punched regions are numbered consecutively starting with “01.” For example, if QuickPunch is used to punch in twice on a track called “Lead Gtr,” a region for the parent audio file appears and is named “Lead Gtr\_01,” and two regions for the punches are named “Lead Gtr\_01-01” and “Lead Gtr\_01-02.”

If you stop playback and record additional punches with QuickPunch, subsequent regions are named by incrementing the first two digits in the name. For example, on the second pass, the punched regions are named “Lead Gtr\_02-01,” “Lead Gtr\_02-02,” and so forth.

---

## TrackPunch Audio Recording

### (Pro Tools|HD Systems Only)

TrackPunch makes Pro Tools more useful as a digital dubber for film re-recording (dubbing) and mixing. Keyboard shortcuts and Preference settings for recording and input monitoring, provide flexibility that makes TrackPunch equally useful for loading dailies and recording Foley, as well as over-dubbing and tracking in music sessions.

## TrackPunch Usage Guidelines

### TrackPunch and Dynamically Allocated Voicing

When using TrackPunch with a Pro Tools TDM system configured for maximum voices, make sure to set the voice assignment for each audio track to *dyn* for Dynamically Allocated Voicing (this mode was previously known as Auto Voice mode). This ensures that Pro Tools can automatically manage voices most efficiently.

## Audio Files and TrackPunch

After a TrackPunch recording pass, the punched track’s playlist in the Edit window displays the regions created by punching. You can use the Trimmer tool after punch recording to open up the head or tail of TrackPunch (and QuickPunch) recorded regions, or to reveal the parent audio file that was recorded in the background. This lets you compensate for any late or missed punches (from as early as the start of playback, or the point at which the track was TrackPunch or QuickPunch enabled).

## Voice Requirements for TrackPunch Recording

TrackPunch requires two voices for each record enabled, mono track. This means that you can record up to half the total number of voices available on your system.

When switching to TrackPunch mode, you will be prompted to free up additional voices if not enough are available.

### To free up voices on tracks that are not record enabled, and do not need to be heard while recording:

- Set voice assignments for tracks to Off.
  - or –
- Make tracks inactive.

As necessary, voices in use by other tracks may be “stolen” while recording with TrackPunch (thus silencing some tracks).

TrackPunch voice playback priority follows the same guidelines as QuickPunch, as follows (from highest to lowest playback priority):

- Tracks with assigned voices that are not record enabled
- Tracks with assigned voices that *are* record enabled
- Auto-voiced (dynamically allocated voicing) tracks that are not record enabled
- Auto-voiced tracks (dynamically allocated voicing) that *are* record enabled

If the session has plenty of available voices, you may have no trouble using TrackPunch with auto-voiced tracks. However, if you are running out of voices, and want to ensure that a track will be heard when recording with TrackPunch, assign it a voice.

## Recording with TrackPunch Overview

Before using TrackPunch, configure Pro Tools and TrackPunch as follows:

### To configure Pro Tools and TrackPunch:

- 1 Configure TrackPunch preference settings as suggested in “TrackPunch Preferences” on page 196.
- 2 If necessary, configure Pro Tools synchronization settings for online recording and track arming (see “Configuring Synchronization and Track Arming” on page 197).
- 3 If necessary, program and configure the master synchronizer for remote control of TrackPunch and TrackInput switching (refer to the documentation from the manufacturer).

### To use TrackPunch:

- 1 Make sure Pro Tools is not recording or playing back (the Transport is stopped).
- 2 Make sure that Use Delay Compensation is deselected in the Operations menu. (Pro Tools 6.4)

 *Digidesign recommends recording without Delay Compensation. For more information about using Delay Compensation, see “Delay Compensation” on page 428.*

- 3 Enable TrackPunch mode (see “Enabling TrackPunch Mode” on page 198).
- 4 TrackPunch enable all audio tracks that you want to punch during the record pass (see “TrackPunch Enabling Tracks” on page 199).

**5** Configure monitoring for record enabled tracks by selecting the appropriate mode from the Operations menu, as appropriate. Choices include:

- Change Record Enabled Tracks to Auto Input
- Change Record. Enabled Tracks to Input Only

Choosing either monitoring mode only affects tracks that are record enabled.



*You can also use the track Input buttons to switch the monitor source for record enabled tracks, as explained below.*

**6** Begin playback.

**7** If you want to compare levels of the input source with audio on disk, click the track Input button. When lit (green), the track is monitoring input. When unlit (grey), the track is monitoring from disk. (For more information see “TrackInput Monitoring” on page 141.)

**8** To punch tracks one at a time, arm the Transport Record and then use the individual track Record buttons to punch each track in and out on-the-fly.

**9** To punch multiple tracks simultaneously, do either of the following:

- Record enable as many as 16 TrackPunch enabled audio tracks, then use the Transport Record button to punch them in and out simultaneously.

– or –

- Arm the Transport Record first, then use Alt+Shift (Win) or Option+Shift (Macintosh) to simultaneously punch on all currently selected TrackPunch enabled tracks.



*Use groups for single-click selection of multiple tracks (click to the left of the group name in the Groups list).*

**10** While continuing local or remote playback, do any of the following:

- Punch in on other TrackPunch enabled tracks individually.
- After punching out, take tracks out of record enable then record enable different TrackPunch enabled tracks.
- Repeat as needed to punch other stems, tracks, or takes.

## TrackPunch Preferences

The following preference settings let you customize TrackPunch performance.

### QuickPunch/TrackPunch Crossfade Length

Pro Tools can automatically write a crossfade for each punch point when using TrackPunch. The length for these crossfades is set with the QuickPunch Crossfade/TrackPunch Length option in the Editing Preferences.

#### To set the TrackPunch Crossfade Length:

- 1** Choose Setups > Preferences, and select the Editing tab.
- 2** Enter a new value (in msec) for the QuickPunch /TrackPunch CrossFade Length.

## Transport and Track Record Settings

The TrackPunch preferences appear on the Operation page of the Pro Tools Preferences dialog.

These preferences specify how track and Transport record status respond when the Transport is stopped (during playback and recording), and let you optimize Pro Tools for film, video, and music production workflows as noted in the following sections.

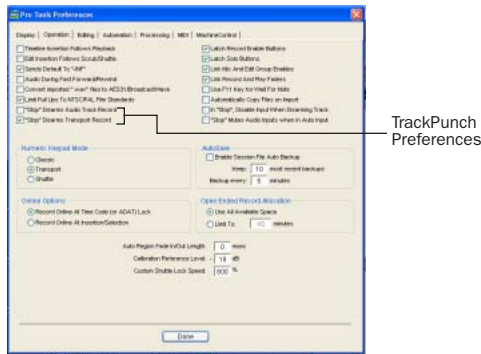

TrackPunch Preferences

### Transport RecordLock

This setting lets the Transport Record be configured to either emulate a digital dubber, or to maintain legacy behavior for the Transport master Record.

- ◆ When not enabled, the Transport Record disarms when Pro Tools is manually stopped or stops due to a loss of time code. This replicates legacy Pro Tools recording behavior.
- ◆ When enabled, the Transport Record remains armed when playback or recording stops. This saves having to re-arm the Transport between takes, emulating digital dubber behavior.

 *Punching out of record by pressing Record on the Transport will take the transport out of record enable.*

### Destructive Recording and Transport RecordLock

As a precaution against accidentally recording over previous material, the Transport RecordLock preference is automatically disabled and greyed out when Destructive record mode is enabled.

### Audio Track RecordLock

This setting lets Pro Tools tracks be configured to either emulate a digital dubber, or to maintain legacy behavior for track record status.

- ◆ When the Audio RecordLock preference is enabled, the record-enabled audio tracks remain armed when playback or recording stops.
- ◆ When the Audio RecordLock preference is not enabled, record-enabled audio tracks are taken out of record enable when Pro Tools is stopped. This prevents tracks from remaining armed from pass to pass, emulating track record behavior of a digital dubber.

### Destructive Recording and Transport RecordLock

As a precaution against accidentally recording over previous material, the Transport RecordLock preference is automatically disabled and greyed out when Destructive record mode is enabled.

### Configuring Synchronization and Track Arming

For online recording and punching, configure the following Peripheral and Session Setup settings. For best lockup times when synchronizing, it is recommended that no more than 16 tracks be TrackPunch-enabled at a time.

### To record online using TrackPunch and TrackInput switching:

**1** Choose Setup > Peripherals, and make sure the SYNC I/O is the selected synchronization peripheral, and is communicating with Pro Tools.

**2** Choose Windows > Session Setup, and do the following:

- Select a Clock and Positional reference.
- If you want Pro Tools to be the time code master, enable Using SYNC/USD. This option is located in the Generator controls in the Time Code Settings section of the Session Setup window.

**3** If you are controlling Pro Tools via 9-pin protocol, do the following:

- Click the Machine Control tab to display the Machine Control page of the Peripherals dialog.
- Configure Remote 9-pin Deck Emulation mode settings (see the *MachineControl Guide* for details).
- Click OK to close the Peripherals dialog.

**4** Configure your master synchronizer as required to control Pro Tools track Record and Input switching through P2 commands. See the documentation for your controller for more information.



*Consult the manufacturer of your controller for the most recent machine profiles and updates available for Pro Tools support.*

## Enabling TrackPunch Mode

Before you can enable individual audio tracks for TrackPunch recording, TrackPunch mode must be enabled in the Pro Tools transport.

### To enable TrackPunch mode:

**1** Make sure Pro Tools is not recording or playing back (the Transport is stopped).

**2** Do one of the following:

- Select Operations > TrackPunch.
- Start-click (Windows) or Control-click (Macintosh) the Transport Record button to cycle through available Record modes until TrackPunch mode is selected (a “T” indicates TrackPunch mode).
- Press Control+Shift+T (Windows) or Command+Shift+T (Macintosh).



*Transport Record with TrackPunch mode enabled*

## Transport Display of TrackPunch Status



TrackPunch and TrackInput status LEDs in the Transport window

### Transport Record Button

The Transport Record button indicates TrackPunch and Record status as follows:

#### When TrackPunch mode is enabled:

- ◆ A “T” appears in the Transport Record button.
- ◆ If at least one track is TrackPunch-enabled, the Transport Record button lights solid blue.

#### When TrackPunch mode is enabled and the transport is armed for recording:

- ◆ If no tracks are TrackPunch-enabled, the Transport Record button flashes grey and red.
- ◆ If at least one track is TrackPunch-enabled, the Transport Record button flashes blue and red, *and* the record LED lights.
- ◆ If at least one TrackPunch-enabled track is also record enabled, the Transport Record button flashes blue and red, *and* the record LED lights.
- ◆ Whenever at least one audio track is recording, the Transport Record button lights solid red.

## Record and Input Status LEDs

Record and Input LEDs next to the Transport Record button indicate track Record and Input status as follows, in all recording modes:

**Record Status LED** When lit (red), indicates that at least one audio track is currently record-enabled. When off (grey), no tracks are currently record-enabled.

**Input Status LED** When lit (green), indicates that at least one audio track is currently set to Input Only monitoring (regardless of record enable status). When off (grey), all tracks are in Auto Input monitoring.

 *Track record buttons also appear in blue to indicate that track is TrackPunch-enabled. See “Track Record Status Display” on page 200 for more information.*

## TrackPunch Enabling Tracks

You can TrackPunch enable tracks without record enabling them, which lets you punch in individual tracks after you start playback.

#### To TrackPunch enable or disable an audio track:

- Start-click (Windows) or Control-click (Macintosh) the track’s Record Enable button to toggle the button to solid blue.

#### To TrackPunch enable or disable all audio tracks:

- Alt-Start-click (Windows) or Option-Control-click (Macintosh) a track’s Record Enable button to toggle the all Record Enable buttons to solid blue.

## To TrackPunch enable or disable all selected audio tracks:

■ Start-Alt-Shift-click (Windows) or Control-Option-Shift-click (Macintosh) a track's Record Enable button to toggle the Record Enable buttons for the selected audio tracks solid blue.

 Create track groups for each stem or set of tracks on which you plan to punch. Use the Groups List to quickly select all tracks in the group. This makes it easier and faster to take multiple tracks in and out of TrackPunch enable simultaneously.

## Track Record Status Display

Each track's Record Enable button indicates its TrackPunch and record enable status as follows:

- When a track is both TrackPunch-enabled and record-enabled, its Record enable button flashes blue and red.



Record Enable button

### TrackPunch status indication in an audio track in the Mix window

- When a track is TrackPunch-enabled but not record-enabled, its Record Enable button lights solid blue.
- When a track is record-enabled only, its Record Enable button flashes red.

- While a track is recording (in any mode), its Record Enable button lights solid red.



Red (not flashing) indicates recording (all modes)

### Track Record status in the Edit window

## TrackPunch Recording

After you have put Pro Tools in TrackPunch mode, and enabled tracks for TrackPunch recording, you can record with TrackPunch in several ways.

## Punching In On Single Tracks

### To punch in on single tracks:

- 1 Put Pro Tools in TrackPunch mode.
- 2 Start-click (Windows) or Control-click (Macintosh) the Record Enable button for each track you want to punch in, so that the track is TrackPunch-enabled only. The track's Record Enable button should light solid blue.
- 3 Click Record in the Transport window to enter the TrackPunch Record Ready mode. The Record button flashes blue and red.
- 4 Click Play in the Transport window to begin playback.
- 5 During playback, punch in and out on individual TrackPunch-enabled tracks by clicking their Record Enable buttons.
- 6 Stop playback. When you are finished with the record pass, track Record Enable status and transport Record Arm status follow the current TrackPunch preference settings.



## Punching In on Multiple Tracks

**To punch in on multiple tracks simultaneously:**

- 1 Put Pro Tools in TrackPunch mode.
- 2 Click the Record Enable button on each track you want to punch in, so that the track is both TrackPunch- and Record-enabled. The track's Record Enable button should flash blue and red.
- 3 Click Play in the Transport window to begin playback.
- 4 During playback, click Record in the Transport window to punch in and out on all TrackPunch-enabled tracks simultaneously.
- 5 Stop playback. When you are finished with the record pass, track Record Enable status and transport Record Arm status follow the current TrackPunch preference settings.

## Start Recording on All Tracks

- 1 Put Pro Tools in TrackPunch mode.
- 2 Click the Record Enable button on each track you want to punch in, so that the track is both TrackPunch- and Record-enabled. The track's Record Enable button should flash blue and red.
- 3 Click Record in the Transport window to enter the TrackPunch Record Ready mode. The Record button flashes blue and red.
- 4 Click Play in the Transport window to begin playback.
- 5 During playback, punch out and back in on individual TrackPunch-enabled tracks by clicking their Record Enable buttons.
- 6 Stop playback. When you are finished with the record pass, track Record Enable status and transport Record Arm status follow the current TrackPunch preference settings.

## Example TrackPunch Workflows

With TrackPunch, Pro Tools emulates and enhances the following four types of production work (or “workflows”) commonly performed in film, video, and music production:

- Dubbing and mixing film (see “Film Dubbing and Mixing with TrackPunch” on page 201)
- Loading dailies (see “Loading Dailies with RecordLock” on page 202)
- Recording Foley (see “Foley Recording with TrackPunch” on page 203)
- Tracking and overdubbing in music production and any other recording situation (see “Tracking and Overdubbing Music with TrackPunch” on page 203)

Each of these workflows takes advantage of TrackPunch features and options.

In the following example workflows, it is assumed you already familiar with routing, selecting, and grouping Pro Tools tracks. If you are not, see the appropriate topic in *Pro Tools Reference Guide*.

### Film Dubbing and Mixing with TrackPunch

By providing all the essential online punch recording and monitor switching capabilities of a digital dubber, TrackPunch optimizes Pro Tools for re-recording and mixing for film.

Film dubbing and mixing features of TrackPunch let you do the following:

- Arm and punch Pro Tools audio tracks remotely from a master synchronizer such as SoundMaster through P2 commands at any time, without having to stop playback and while maintaining time code lock. (Requires Digidesign MachineControl.)

- Toggle Pro Tools audio tracks between input and disk monitoring. Track input switching can be controlled remotely by supported synchronizers to fully emulate PEC/direct switching (requires Digidesign MachineControl).
- Use TrackPunch when Pro Tools is the time code master (generating) and when slaving.
- Use Pro Tools file management features to consolidate and “clean up” sessions in a fraction of the time required by tape-based dubbers.
- Because Pro Tools can be networked, TrackPunch (and all other) audio files and whole sessions can be available for secure transfer to other systems for review, editing, and archiving.

**A typical pre-dub session using TrackPunch includes the following steps:**

- 1** Configure synchronization between Pro Tools and other devices as appropriate.
- 2** Choose Setups > Preferences, and click to show the Operations pane, then do the following:
  - Check (enable) the preference Transport RecordLock. This will keep the Transport Record armed after the transport stops.
  - Deselect the preference Audio Track RecordLock. This will cause the audio track record to disarm when the transport stops.
- 3** Choose Operations > TrackPunch to enable TrackPunch mode.
- 4** Create 32 new tracks, then do the following:
  - Assign their inputs
  - Group them into eight-track groups.
- 5** Click the record enable buttons in the first eight tracks to TrackPunch enable the first eight tracks (or, the group for the first pre-dub).

 Use the Groups list to quickly select all tracks in the group, and Alt-Shift-click (Windows) or Opt-Shift-click (Macintosh) to record-enable all the tracks in the group.

- 6** Assign the console PEC/direct paddles to the first eight-track group in the session.
- 7** Begin the pre-dub pass. Use the console paddles to arm Pro Tools, and to punch in and out on the first group.
- 8** When the first pre-dub is over and all tracks are punched out, clear all TrackPunch enabled tracks.
- 9** Select the next group of tracks and TrackPunch-enable them.
- 10** Punch in and out on the second group of tracks.
- 11** Repeat as needed.

## **Loading Dailies with RecordLock**

In addition to its uses on dub and mix stages, Pro Tools with TrackPunch makes it easy to load dailies. Dailies and similar types of transfers are comprised of multiple takes or scenes, each recorded while locked to unique time-of-day time code. In between each take, time code does not continue but stops completely. Because of this, the time code on dailies and similar source material is said to be “discontiguous” or discontinuous (also known as broken time code).

When a session is taken offline while recording due to broken time code, Pro Tools remains armed and waits for time code to resume. Pro Tools begins recording again when lock is re-established with the time code of the next take. Each take is recorded to its own audio file.

### To configure RecordLock for loading:

- 1 Choose Setups > Preferences, and click to show the Operations pane.
- 2 Select the preference Transport RecordLock.
- 3 Select the preference Audio Track RecordLock.
- 4 Configure synchronization and other settings as required. Put Pro Tools online, and start the external source player.
- 5 Whenever time code drops out or stops, Pro Tools remains online and waits to receive new time code. The Transport and record enabled tracks remain record enabled (or TrackPunch enabled). When time code resumes, Pro Tools begins recording to a new audio file (properly time stamped based on the incoming code).

**A** *Because Pro Tools has a 13-hour timeline limit, you will have to use multiple sessions to load dailies if the span is more than 13 hours.*

## Foley Recording with TrackPunch

Foley recording is one of the more specialized forms of recording in film production with unique monitoring requirements. Between punches and takes, inputs must be muted while Foley artist move themselves and equipment as they progress through a scene.

TrackInput monitoring can be configured to support Foley style TrackPunch recording using the preference “Stop” Mutes Audio Inputs (When In Auto Input).

### To configure Pro Tools for Foley-style punch record monitoring:

- 1 Choose Setups > Preferences, and click to show the Operations pane.
- 2 Enable the preference “Stop” Mutes Audio Inputs (When In Auto Input.)
- 3 Configure synchronization and other settings for Pro Tools and your other devices, then enable TrackPunch mode and proceed with punch recording. (See “Recording with TrackPunch Overview” on page 195 for the complete steps.)

While Mute Audio Inputs in Auto Input is enabled, and while recording online, record-enabled tracks mute when the Transport is stopped. Input can still be monitored at any time by using the track Input switch.

## Tracking and Overdubbing Music with TrackPunch

Modern multitrack recording requires the flexibility to “capture the moment” by allowing on-the-fly record enabling and punch recording, as provided by TrackPunch. Features of TrackPunch for all tracking, overdubbing, and punching situations include the following:

- Record enable tracks on-the-fly.
- Punch tracks in and out using onscreen Record buttons, remotely from a synchronizer, from a control surface, or using a foot switch.
- Compare and match levels using TrackInput monitor switching.



# Part IV: Editing



# Chapter 15: Editing Basics

---

## Pro Tools Editing

The Edit window in Pro Tools provides a powerful collection of tools for editing and assembling audio and MIDI. Track material can be edited nondestructively and in real time during playback.

The Edit window also lets you graphically edit track automation. For more information on Automation in the Edit window, see Chapter 28, “Automation.”

## Nondestructive Editing

The vast majority of audio editing in Pro Tools is nondestructive. Whether cutting, pasting, trimming, separating, or clearing regions, you are only performing these functions on a map of the actual audio data. The source audio files remain untouched. If a particular process or tool works destructively (that is, if it can permanently change audio files on your hard disk), this guide alerts you.

While editing for MIDI tracks is in some instances destructive, with a few precautions you can keep important MIDI tracks and regions safe when performing edits (see “Nondestructive MIDI Editing” on page 217).

## Editing During Playback

Pro Tools lets you perform many editing tasks while the session plays. This powerful capability allows you to interactively modify and edit a session, hearing the changes as you make them. You’ll find many instances where you can use this capability to increase your productivity when working with a session.

Following are just a few examples of editing that can be performed while your tracks loop or play:

- Capture, separate, and trim regions
- Place, spot, or rearrange regions
- Add fades or crossfades to audio regions
- Transpose, quantize (including Groove Quantize), and otherwise modify MIDI tracks
- Nudge audio or MIDI regions
- Audition different playlists
- Adjust or scale automation data
- Insert a real-time plug-in
- Process audio with an AudioSuite plug-in
- Automation breakpoint editing

There are a few things that cannot be changed while Pro Tools plays. These include routing to sends and assigning outputs.

---

## Track Material

Each time you record or import audio and MIDI, Pro Tools creates *regions* for the new track data, which not only indicate where the material begins and ends, but also provides good feedback on its general shape and content. When you record additional takes, or “punch in” on a specific location within a track, Pro Tools creates additional regions.

Regions are also created by cutting and pasting, resizing, separating, and re-capturing existing regions. Regions in a session are listed in the Audio Regions List and MIDI Regions List, where they can be dragged to existing tracks. A track can contain any number of regions, in any arrangement. The order and location of regions in a track define its *playlist*.

 *In addition to audio and MIDI regions, tracks also provide automation playlists. Automation can be recorded and edited in the Edit or Mix windows. For more information, see Chapter 28, “Automation.”*

### Region Types

There are different region types, based on how they are created:

**Whole-File Audio Regions** These audio regions are created when recording or importing audio, consolidating existing regions, and when non-destructively processing with an AudioSuite plug-in. Whole-file audio regions reference an entire audio file that resides on your hard drive. Whole-file audio regions are displayed in bold in the Audio Regions List (see “The Audio and MIDI Regions Lists” on page 220). Normal regions often reference only a portion of the parent audio file and are created in the course of editing and, in some instances, when punch recording.

**User-Defined Regions** These are regions that are explicitly defined, such as when you record or import audio or MIDI; capture, separate, or consolidate a selection; trim a whole-file audio region; and rename an existing region.

**Auto-Created Regions** These regions are automatically created in the course of editing, and, in some instances, when punch recording over existing regions. Since these regions can accumulate rapidly in a session, you can hide them so they don’t appear in the Audio and MIDI Regions List (see “Naming and Displaying Regions” on page 311). Auto-created regions can be turned into user-defined regions by renaming them.

**Offline Regions** Regions are *offline* when their parent audio files cannot be located, or are not available, when opening a session or importing a track. Offline regions appear in the Audio Regions List as italicized and dimmed; they appear in playlists as light blue regions with italicized names. Offline regions can be edited like other regions, but they cannot be processed with AudioSuite plug-ins.

**Multichannel Regions** These regions, which are displayed as a single region in the Audio Regions List, reference multiple regions and audio files for stereo and surround tracks. Multichannel regions can be expanded (by clicking the triangle next to their name) to see the individual channels, which can be dragged independently to tracks.



## Track View

The Track View determines which data is displayed and edited in the track's playlist area. Track View data can be set to Blocks, Waveform, Volume, Pan, Mute, or an automated control, based on the track type:

**Audio Tracks** These tracks can be set to *Blocks*, *Waveform*, *Volume*, *Pan*, *Mute*, or any plug-in controls that have been automated. Except when editing automation data, audio tracks are by default set to Waveform, where track material is graphically drawn with amplitude waveforms (a time-domain representation of sound). This Track View provides the necessary detail for important region edits.

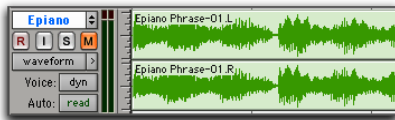

Track View set to Waveform for audio track

**Auxiliary Input Tracks** These tracks can be set to *Volume*, *Pan*, *Mute*, or any plug-in control that has been automated.

**Master Fader Tracks** These tracks can be set to *Volume*, or any plug-in control that has been automated.

**MIDI Tracks** These tracks can be set to *Blocks*, *Regions*, *Notes*, *Volume*, *Pan*, *Mute*, *Velocity*, *Pitch Bend*, *After Touch*, *Program*, *Sysex*, and any continuous controller type. Except when editing controller data, program changes, or Sysex events, MIDI tracks are commonly set to *Notes* or *Regions*, each of which displays notes in a

“piano roll” format. Use *Notes View* for inserting, editing, and copying and pasting MIDI notes; use *Regions View* to arrange, capture, or consolidate regions.



Track View set to Regions for MIDI track

With the Track View set to *Blocks*, audio and MIDI regions are displayed as empty blocks bearing the region's name. This mode is most useful once you have finished capturing and editing regions at the waveform or MIDI event level and are moving and rearranging them. Screen redraws are fastest with this format.

When an audio track is displayed as *Volume*, *Pan*, or another automated control, or when a MIDI track is set to one of the continuous controller types (*Volume*, *Pitch Bend*, *After Touch*), the data for that track appears in the form of a line graph with a series of editable breakpoints. The breakpoints can be dragged to modify the automation data, and new breakpoints can be inserted with the Pencil or Grabber.

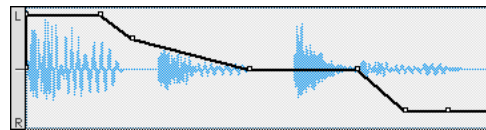

Track View set to Pan for audio track

For details on editing automation data for audio tracks, see Chapter 28, “Automation.” For details on inserting and editing controller data for MIDI tracks, see “Continuous Controller Events” on page 364.

### To set the Track View:

- Click the Track View Selector for the track and choose the format from the pop-up menu.

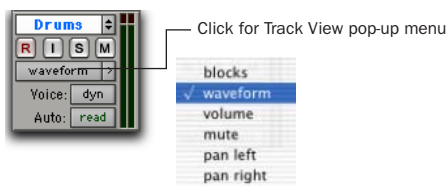

### Audio Track View Selector

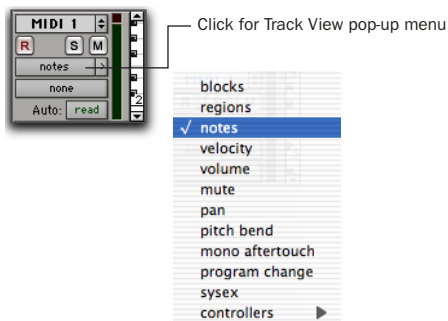

### MIDI Track View Selector

The track displays the new format. If the track is part of an active Edit Group, all tracks in the group are set to the new format.

## Toggle Track Views

Most editing of audio tracks occurs in Waveform and Volume View. For MIDI tracks, most editing occurs in Notes and Regions View. Pro Tools provides an easy way to toggle these views for tracks containing an edit selection or the edit cursor.

### To toggle Track Views:

- 1 Click in the track you want to toggle. To toggle multiple tracks, Shift-click or drag the Selector to select additional tracks.

- 2 Press Start+Minus (Windows) or Control+Minus (Macintosh) on the alpha keyboard.

– or –

With the Commands Focus enabled, press Minus on the alpha keyboard.

Audio tracks are toggled between Waveform and Volume View. MIDI tracks are toggled between Notes and Regions View.

## The Master View Format

Audio and MIDI tracks have Track Views that act as “master.” When a track is displayed in its master format, any edits performed apply to all data in the track. For instance, when an audio track is set to Waveform, copying and pasting affects not just the waveform information, but all of the automation data as well.

The Track Views that act as master for audio and MIDI tracks are:

- Audio tracks: Waveform and Blocks
- MIDI tracks: Regions, Blocks, and Notes (when using the Selector)

Auxiliary Input tracks and Master Fader tracks do not have a Master View. This means that any edits made to an Auxiliary Input or Master Fader track affect any automation data in that track

## Track Height

Tracks can be viewed in the Edit window at any of six heights: *Mini*, *Small*, *Medium*, *Large*, *Jumbo*, and *Extreme*. Larger track heights are particularly useful for precise editing. Smaller track heights are useful for conserving screen space in a large session.

You can adjust track heights on an individual track basis or set all tracks to the same height. Track heights can be adjusted during playback.

### To set the Track Height:

- Click the small arrow next to the Track View Selector to get the Track Height pop-up menu.

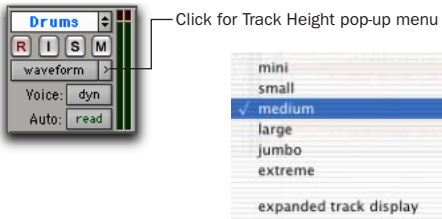

### Track Height pop-up menu

– OR –

- Click in the area just to the right of the track controls and choose the height from the pop-up menu.

The track is resized to the new height. If the track is part of an Edit Group, all tracks in the group are set to the new height.

 Press **Start+Up/Down Arrow key** (Windows) or **Control+Up/Down Arrow key** (Macintosh) to increase/decrease track height of any track that contains a selection or in which the edit cursor is currently placed.

### Expanded Track Display

Stereo and multichannel tracks share a single playlist for volume and mute. This shared playlist normally occupies the entire height of the track, extending across all channels.

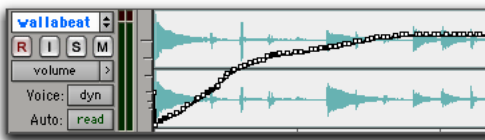

Volume playlist for stereo track

With Expanded Track Display, you can display playlists individually for each channel, thereby allowing for more accurate breakpoint editing. This is also useful for editing pan or multi-mono plug-in data, both of which can be different for each channel.

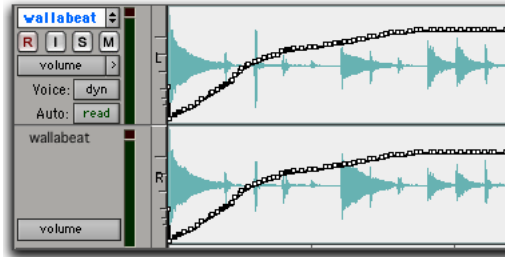

Stereo track in Expanded Track Display

Expanded Track Display also provides for a larger waveform display (equal to that of mono audio tracks), as well as a separate Track View Selector and meter for each channel.

### To turn on Expanded Track Display for a stereo or multichannel track:

- From the Track Height pop-up menu, select Expanded Track Display.

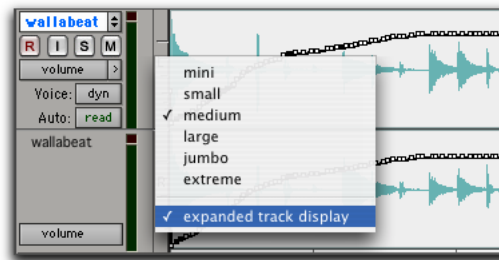

Track Height pop-up menu

### Track Controls and Track Height

The Track Height affects how the various track controls appear in the Edit window. For instance, when a track's height is set to Small, most of the buttons are reduced in size.

When the Track Height is set to Mini, only controls for Record, Solo and Mute appear, and the menus for Playlist, Track Height, and Track View are accessed from the same pop-up menu.

When the Track Height is set to Large, Jumbo, or Extreme, all track controls are displayed at their full size.

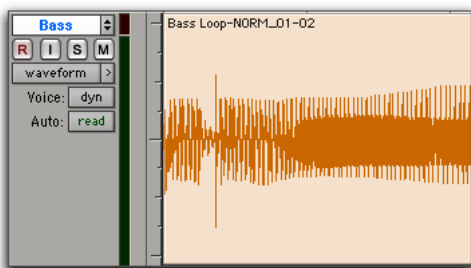

Track Height set to Large

## Displaying Region Names and Times

Region names can sometimes get in the way of editing audio waveforms and MIDI data. In these instances you may want to disable their display.

### To disable the display of region names in playlists:

- Deselect Display > Display Name In Regions.

### To enable the display of region names in playlists:

- Choose Display > Display Name In Regions. This is extremely useful when working with film and video.

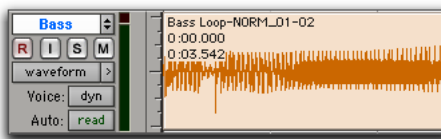

Display enabled for region names and times

### To display region times:

- From Display > Display Time In Regions, select one of the following options:

**None** Disables display of region times.

**Current Time** Displays start and end times for regions.

**Original Time Stamp** Displays the Original Time Stamp for each region. The Original Time Stamp is the original time code location for the region when it was first recorded or created.

**User Time Stamp** Displays the User Time Stamp for each region. The User Time Stamp, which defaults to the Original Time Stamp, can be re-defined with the Time Stamp Selected command.

## Audio Regions and Waveforms

When the Track View for audio tracks is set to Waveform, Pro Tools draws a waveform diagram of the audio. Audio waveforms tell you several things about the recorded sound.

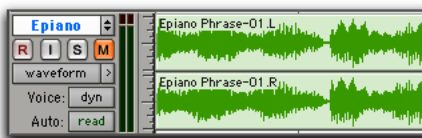

Figure 8. Audio waveform of an electric piano

Figure 8 shows an audio waveform for a drum track. The “peaks” represent places in the recording (beats) where the attack of the sound causes the volume to increase momentarily. These are followed by “valleys,” where the volume decreases.

Different types of sounds produce different types of waveforms. Drums, for example, generally produce waveforms with sharp *transients* (peaks of short duration) that are clearly defined. A drum hit has a loud, sharp attack and a rapid decay.

Other sounds, such as vocals or sustained keyboard sounds, produce very different waveforms, ones that have less pronounced peaks and valleys. That's because these sounds generally have softer attacks and longer decays.

### Draw Waveforms Rectified Preference

When the Display Preference for Draw Waveforms Rectified is selected (Setups > Preferences > Display), audio waveforms are displayed so that their positive and negative waveform excursions are summed together and viewed as a single positive-value signal. However, even when this preference is enabled, zooming in beyond a certain point will cause the waveforms to be displayed normally.

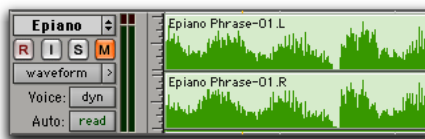

Audio displayed in Rectified mode

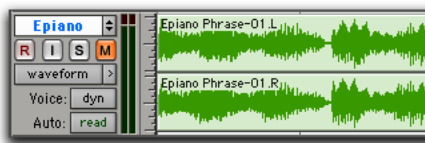

Audio displayed in Normal mode

Rectified mode displays more detailed waveforms when using track heights of Medium or Small, and can be particularly useful when editing volume automation data, since it depicts waveform “levels” as starting at the bottom of the track.

### Guidelines for Editing Waveforms

With the Selector tool in the Edit window, you can select portions of audio waveforms and divide them into segments called *regions*, so that you can rearrange and manipulate them in tracks.

While editing, try to create regions that allow you to maintain a consistent beat. If you always define regions so that they contain a whole number of beats, you'll be able to string the regions together and maintain a smooth, steady rhythm.

It's sometimes useful to have a steady, well-defined waveform (such as a drum track) as a guide when selecting and defining other regions. If you've played in time with the beat, chances are that you can create rhythmically accurate regions by referring to the drum waveform.

Some important rules to keep in mind when defining regions:

- ◆ Whenever possible, begin a region precisely before a volume peak, and end it immediately before another volume peak.
- ◆ Whenever possible, make sure a region starts and ends on exactly the same part of a beat.

### Avoiding Clicks and Pops

If an edited region begins or ends at a point of high amplitude, you may hear an unpleasant click when Pro Tools plays from one region to another. In order to avoid clicks or pops do any of the following:

- ◆ Make sure that the start and end points of your selection are as close as possible to the point where the amplitude of the waveform tapers down to meet the zero-crossing line (the

center line of the track's waveform display). If necessary, use the zooming tools in the Edit window (see "Zooming" on page 226) to display waveforms in greater detail.

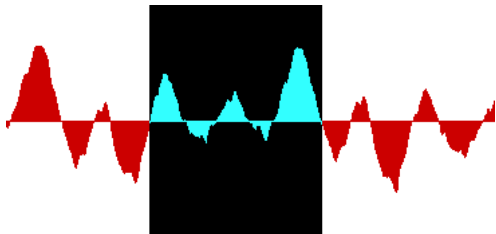

*Selection that begins and ends at zero crossings*

- ◆ On Pro Tools TDM systems, use the AutoFade feature to apply real-time fade-ins/outs to all region boundaries that do not touch or overlap other regions. See "Using AutoFades" on page 305 for details.
- ◆ Apply a crossfade between regions where a click or pop occurs. See "Creating a Crossfade" on page 302 for details.

## **Nondestructive Audio Editing**

When editing an audio track's playlist in Pro Tools, you're not actually cutting and moving pieces of sound as you would if you were cutting and splicing analog tape. Instead, Pro Tools creates a map of the audio file on your hard disk, which describes the order in which to play the track portions.

When trimming audio regions with the Trimmer tool, or when editing the placement or order of regions within a track, use multiple playlists to easily return to a track's previous state. See "Playlists" on page 217 for details.

## **Audio Regions and Automation Data**

Automation data for audio resides in tracks and *not* in the Regions List. This means that when you drag an audio region from the Audio Regions List to a new track, no automation data is placed in the track. However, if you drag an audio region from an existing track (that contains automation data) to another track, the automation from the source track is placed in the destination track.

---

## **MIDI Regions and MIDI Data**

The two most common Track Views you'll use for MIDI tracks are Notes and Regions. Use Notes View for inserting and editing individual MIDI notes, and for working with and affecting groups of notes.

When you need to experiment with the arrangement of regions, or define new ones, use Regions View.

For more information on setting Track View, see "Track View" on page 209.

 *To toggle the track view, click in the track you want to toggle and press Start+Minus (Windows) or Control+Minus (Macintosh) on the alpha keyboard.*

## Notes View for MIDI Tracks

When a MIDI track's Track View is set to Notes, MIDI notes are displayed in a "piano roll" format. Each note is displayed as a small rectangle with its vertical placement indicating pitch and its horizontal placement indicating location (and duration).

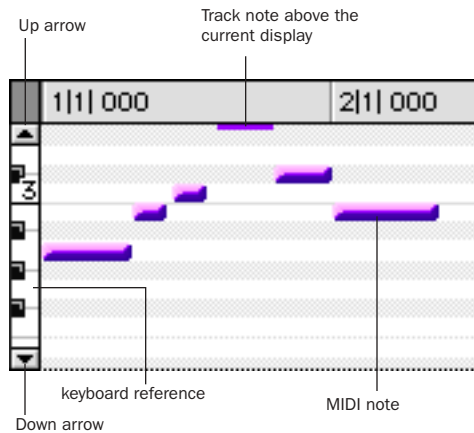

Figure 9. MIDI track displaying notes

To the left of the MIDI track's playlist is a vertical mini-keyboard, complete with octave numbering, for pitch reference. You can Control-click (Windows) or Command-click (Macintosh) the mini-keyboard to audition pitches. Arrows at the top and bottom of the mini-keyboard (not available in the smaller track heights) are used to scroll the Notes display up and down.

The pitch range of MIDI notes that can be displayed depends on the track height, and on the current zoom value. Any time a track's notes do not fit within its current height, notes above or below the viewed area are displayed as single-pixel lines at the very top and bottom of the range (see Figure 9).

**To scroll the Notes display up or down for a MIDI track:**

- Click either the up or down arrow of the mini-keyboard.

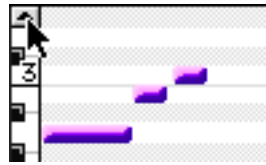

*Scrolling notes with the Up arrow on mini-keyboard*

– or –

- With any of the Edit window tools (such as the Grabber tool) selected, press Control+Alt+Start (Windows) or Command+Option+Control (Macintosh) and drag up or down on the mini-keyboard.

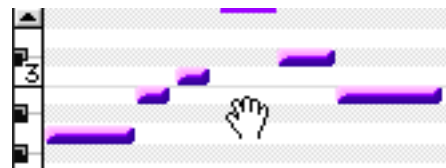

*Scrolling Notes display by dragging*

Using the Edit window tools, notes can be inserted, transposed, trimmed, and moved. For more information, see "Manually Editing MIDI Notes" on page 359.

 *In Pro Tools 6.1, if you have a mouse with a scroll wheel, you can use it to scroll a MIDI track's Notes display. Place the mouse over a MIDI track in the Edit window, and Alt-Start-Control-scroll (Windows) or Command-Control-Option-scroll (Macintosh) the scroll wheel to scroll the Notes display for that MIDI track.*

## Regions View for MIDI Tracks

MIDI tracks can also be viewed as Regions, which is similar to Waveform View for audio tracks. While a track's notes are visible in Regions View, individual note editing is not available in this view. Instead, all editing occurs across a time range encompassing all track data, including continuous controller events, program changes, and System Exclusive events.

Use Regions View to define regions that represent song sections and clips, or to rearrange or assemble track material.

For more information on setting the Track View, see “Track View” on page 209.

 To toggle the track view, click in the track you want to toggle and press *Start+Minus* (Windows) or *Control+Minus* (Macintosh) on the alpha keyboard.

There are, however, a few things to keep in mind when selecting, copying and cutting, and trimming MIDI regions:

- ◆ When cutting or clearing a region selection that includes a note's start point, the entire note is removed. This is even the case when only a portion of the note (that includes its start point) is selected.

- ◆ When copying or cutting a region selection that includes a note's end point (but not its start point), the note remains and overlaps the edge of the region.

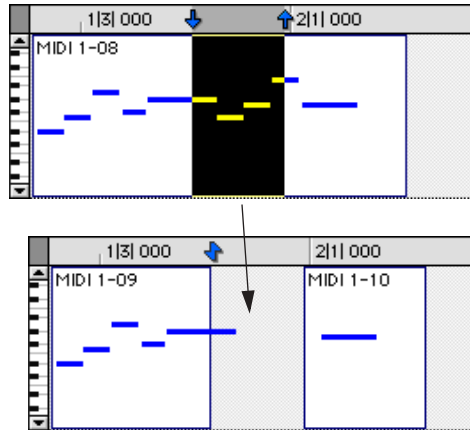

*Cutting a MIDI region with note overlap*

- ◆ Similar rules also apply when MIDI regions are trimmed with the Trimmer tool. If the MIDI region's start point is moved beyond a note's start point, the note is removed. If the region's end point is trimmed so that a note's start point is within the region but its end point is not, the note remains and overlaps the edge of the region.

When moving and placing MIDI regions with overlapping notes, the notes always move with the regions. When placing MIDI regions with overlapping notes next to or near another region, the overlapping notes extend into the adjacent region.



## Nondestructive MIDI Editing

While editing audio regions is usually nondestructive, this is not always the case for MIDI regions. For instance, if a MIDI region resides in just one track at a single location, editing for that region *is* destructive. This means that altering the pitch, duration, or placement of notes in Notes View permanently alters the region.

However, when editing a MIDI region that occurs elsewhere, in the same track (at another location or in a different playlist) or in another track, the editing is nondestructive and occurs to an auto-created region. To go back to the previous material, drag the original region from the MIDI Regions List, or return to a previously saved playlist.



*One way to safely return to a track's previous state is with playlists. Before you edit notes, trim regions, or rearrange the order of regions, make a duplicate of the track's existing playlist and instead work with it (see "Playlists" on page 217).*

## MIDI Regions and Continuous Controller Events

Continuous controller events reside in MIDI regions and not in tracks. This means that when dragging regions that contain controller data from either a track or the MIDI Regions List, the controller data is written to the destination track.

Unlike continuous controller events, which represent nuances that are part of a MIDI performance, Mute in Pro Tools is an automation playlist that actually mutes the MIDI engine. Mute automation does not correspond to actual MIDI events and is therefore not exported when saving as a Standard MIDI File.

## Playlists

The ability to create *playlists* is one of the most powerful features of Pro Tools, and one reason why it is infinitely more versatile than traditional multitrack recorders.

*Edit playlists* allow you to take a snapshot of a track's current arrangement of regions, thereby freeing you to experiment with alternate arrangements, returning as necessary to previously saved playlists.

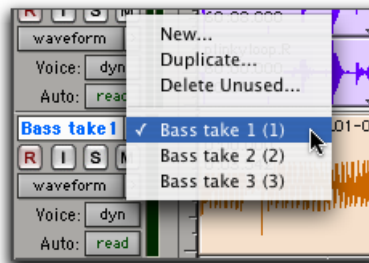

**Playlist Selector pop-up**

A playlist, which can consist of a single region or many regions, can only be assigned to a track if it is not in use by another track. While you can create an almost unlimited number of edit playlists, which are shared among all tracks, each track has its own set of dedicated *automation playlists*.

Automation playlists for audio tracks store data for volume, pan, mute, and plug-in controls. Automation playlists for MIDI tracks, however, store *only* mute information; continuous controller events, program changes, and Sysex events are stored in MIDI regions and therefore reside within edit playlists.

## Playlists and Groups

Playlist functions affect all tracks within an Edit Group (if the group is active). This is useful when you want to switch multiple tracks to a new or existing playlist (such as all the drum tracks).

## Working with Playlists

When you create a new track, it contains a single, empty playlist until you record, import, or drag material to it from the Regions Lists or a DiGiBase browser.

New playlists can be created that are empty or duplicates of the current playlist. Once created, you can recall, rename, and delete playlists as needed

### Duplicating a Playlist

When you edit a track, you can work with a copy of the track's playlist and keep the original playlist arrangement intact.

#### To duplicate a track's current playlist:

- 1 Click the track's Playlist Selector and choose Duplicate from the pop-up menu.
- 2 Enter a name for the new playlist and click OK.

The duplicated playlist appears in the track and the track's name is changed to the name of the new playlist.

New and duplicated playlists are auto-named with the track name, followed by a period and the playlist number (such as the first playlist for a "Kick" track being auto-named "Kick.01"). In this example, subsequent playlists would be auto-named "Kick.02," "Kick.03," and "Kick.04."

## Creating a Playlist

You can also create a new playlist and record or drag regions to it.

#### To create a new (empty) playlist:

- 1 Click the track's Playlist Selector and choose New from the pop-up menu.
- 2 Enter a name for the new playlist and click OK. An empty playlist with the specified name appears in the track.

## Recalling a Playlist

You can recall a previously-created playlist to assign it to that track.

#### To recall and assign a playlist:

- Click the track's Playlist Selector and choose the playlist from the pop-up menu.

The selected playlist appears in the track and the track's name is updated to that of the selected playlist.

As long as a playlist is unassigned, it can be recalled and assigned to any track. Only unassigned playlists appear in the Playlist Selector pop-up menu.

## Renaming a Playlist

You can rename a playlist by renaming the track to which it is assigned.

#### To rename a track's assigned playlist:

- 1 Double-click the track's name.
- 2 Enter a new name and click OK. Both the track and playlist names are updated.

## Deleting a Playlist

You can delete a playlist from a session entirely. However, since playlists take almost no disk space, you don't need to delete them for space reasons.

### To delete one or more playlists from a track:

- 1 Click the track's Playlist Selector and choose Delete Unused from the pop-up menu.
- 2 Select the unassigned playlists you want to delete. Shift-click to select multiple playlists.
- 3 Click OK to delete the playlists. This operation cannot be undone.

 *When deleting a track from a session, you have the option of deleting or keeping its playlists, so they can be used on other tracks.*

---

## Multiple Undo

Pro Tools 6.1 can keep track of up to 32 of the last undoable operations, allowing you to return to a previous editing state. Pro Tools 6.0 and lower support up to 16 Levels of Undo.

The Undo operations in Pro Tools are stored in a queue, in the order in which they were invoked. When choosing Edit > Undo, the most recent operation is undone. If you choose Undo again, the next operation in the queue is undone. You can also choose Edit > Redo to redo an operation, which moves back through the Undo queue by one step.

When the number of operations in the Undo queue reaches the maximum Level of Undo, performing another undoable operation will remove the oldest operation at the bottom of the queue.

For example, suppose the following operations have been performed, with item 1 being the most recent (first in the queue):

- 1 Region cut from track
- 2 Region pasted to track
- 3 Region slid forward
- 4 Regions shuffled
- 5 MIDI note trimmed
- 6 MIDI note inserted with Pencil

In this example, to Undo the region shuffle, you would have to choose Edit > Undo four times, which would also Undo the first three operations in the queue.

If you then choose Edit > Redo, followed by another edit operation, such as a region trim, the Undo queue would then be:

- 1 Region trimmed
- 2 Regions shuffled
- 3 MIDI note trimmed
- 4 MIDI note inserted with Pencil

### To undo the last operation:

- Choose Edit > Undo.
  - or –
- Press Control+Z (Windows) or Command+Z (Macintosh).

### To redo the last undone operation:

- Choose Edit > Redo.
  - or –
- Press Shift+Control+Z (Windows) or Shift+Command+Z (Macintosh).

## Operations that Clear the Undo Queue

Pro Tools will *not* warn you of operations that clear the Undo Queue. Operations that clear the Undo Queue include:

- Deleting a track, or clearing a region from the Audio or MIDI Regions List
- Selecting “Select Unused” in the MIDI Regions List pop-up
- Selecting “Select Unused Regions,” or “Select Unused Regions Except Whole Files” in the Audio Regions List pop-up
- Importing tracks or session data

## Levels of Undo and Memory

Because Pro Tools needs to keep track of the playlists for all tracks that are edited, the use of multiple Levels of Undo can be memory intensive. You can lower the Levels of Undo in Pro Tools to reduce the amount of system memory (RAM) used by the Undo queue. If you have plenty of memory allocated to Pro Tools, you can use higher Levels Of Undo.

### To set the Levels of Undo in Pro Tools:

- 1 Choose Setups > Preferences and click the Editing tab.
- 2 Click in the Levels of Undo field and enter a value of between 1–32 (Pro Tools 6.1) or 1–16 (Pro Tools 6.0 and lower).

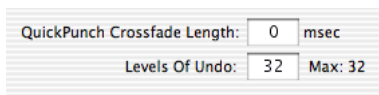

### Levels of Undo preference

- 3 Click Done to close the Preferences dialog.

## The Audio and MIDI Regions Lists

All regions that are recorded, imported, or created by editing appear in the Audio and MIDI Regions Lists. Regions can be dragged from either list to tracks and arranged in any order. Regions can also be auditioned from the Regions List by Alt-clicking (Windows) or Option-clicking (Macintosh) them.

In the Audio Regions List, whole-file audio regions are displayed in bold, and stereo and multichannel regions can be expanded to display individual channels.

Because region names can become lengthy, the Regions List can be scrolled or resized as necessary (see Figure 10). In addition, you can use the pop-up menu at the top of either list to sort, search, rename, and clear regions.

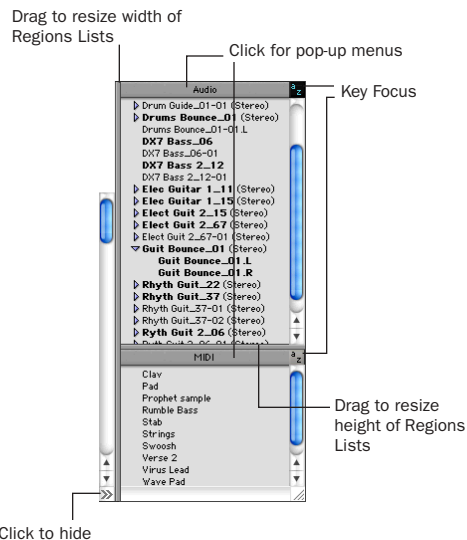



Figure 10. Audio and MIDI Regions Lists

If the Editing Preference for “Region List Selection Follows Track Selection” is enabled, clicking a region in the Regions List highlights it in the track that contains it.

 Use the MIDI Regions List as a bin for storing your favorite MIDI clips. Save the session as a template and the regions are available for future sessions (see “Creating Custom Session Templates” on page 51). Since MIDI regions are tick-based (unlike audio regions), they scale seamlessly for use with any tempo.

## Displaying File Info for Audio Regions

In addition to region names, the Audio Regions List can also display information about the region’s parent audio file:

- Disk name, which represents the name of the hard drive on which it resides
- File name, which represents the audio file from which the region originated
- The full directory Pathname of the region’s location



### Audio Regions with file info

Pro Tools defaults to displaying just the region portion of a region’s name. To display file information for audio regions, choose Show File Names, Show Disk Names, or Show Full Pathnames from the pop-up menu at the top of the Audio Regions List.

 For details on displaying audio file information using DigiBase, see the *DigiBase Guide*.

## Sorting and Searching the Regions Lists

Most sessions will contain many regions, which may make it difficult to locate a particular region in the Regions Lists. The ability to sort regions and search for them will help greatly in keeping track of large numbers of regions.

### To sort regions in a Regions List:

- 1 From the Regions List pop-up menu, choose Sorting and select the basis for sorting from the submenu.

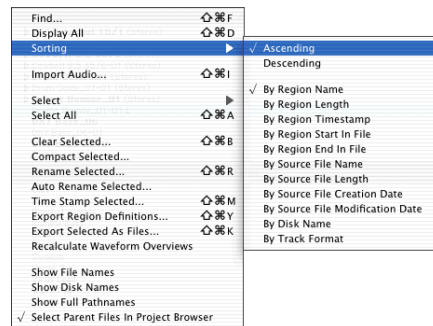

### Sort attributes for audio regions

MIDI regions can be sorted by name, length, or timestamp. In addition to these, audio regions can be sorted by region start and end times, various attributes of the source audio file, disk name, and track format.

- 2 From the Regions List pop-up menu, select Ascending or Descending to switch the order of the displayed regions.

## Finding Regions

Use the Find command to display all regions in a list whose names contain a particular word or phrase.

**To find and display regions that match a word or phrase:**

- 1 Choose Find from the pop-up menu in the Audio or MIDI Regions List.
- 2 Type the name, or any portion of the name, for the regions you want to find, then click OK.

Pro Tools displays all regions whose names contain the name that was specified. Figure 11 shows regions found when searching on the word “loop.” When displaying regions with the Find command, a small diamond appears at the top of the Audio and MIDI Regions List.

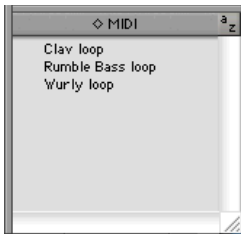

Figure 11. Regions located with Find command

**To return the Regions List to displaying all regions:**

- Choose Display All from the Regions List pop-up menu.

## Selecting in the Region Lists

In the Regions Lists you can select multiple regions so they can be dragged to tracks, processed with AudioSuite plug-ins, or exported.

**To select a range of regions in a Regions List:**

- Move the cursor to the left of the region names, so the Marquee appears, and drag around the regions you want to select.

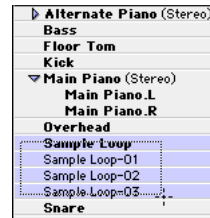

Regions selected with Marquee

– or –

- Shift-click, to the left of the region names, the first and last region you want to select. All regions between become selected.

**To select discontinuous regions in the Regions List:**

- Move the cursor to the left of the region names, so the Marquee appears, then Command-click each region you want to select.

– or –

- Move the cursor over the region names, then Shift-click each region name you want to select.

## Keyboard Selection of Regions

If the Audio Regions Key Focus or MIDI Regions Key Focus is enabled, you can type the first few letters of a region's name and Pro Tools will automatically locate and select the region in the Regions List.

### To enable and use the Audio Regions Key Focus or MIDI Regions Key Focus:

- 1 Click the a-z button in upper right of the Audio Regions List or MIDI Regions List.

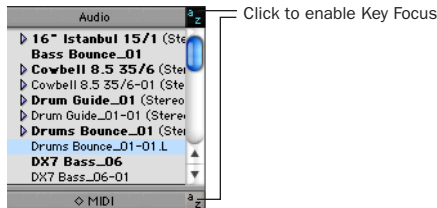

#### Audio Regions List Key Focus enabled

- 2 Type the first few letters of the region to automatically locate and select it. Once a region is located and selected, it can be dragged to a track.

Keyboard selection of audio regions locates regions based on their region name, not on the names for their parent audio files or the volumes on which they reside.

## Stereo and Multichannel Tracks in the Audio Regions List

Stereo and multichannel regions, whether imported or recorded into Pro Tools, are displayed as single items in the Audio Regions List. For example, two mono source regions named “Main Piano.L” and “Main Piano.R” are listed as “Main Piano (Stereo).” An Expand/Collapse triangle indicates stereo and multichannel regions.

Stereo and multichannel regions are displayed in the Regions List by default in collapsed view. The individual regions can be displayed by clicking the arrow to the left of the region to expand the name.

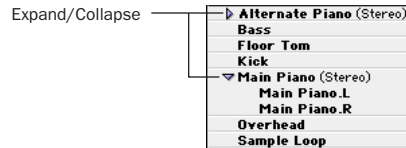

*Stereo regions, collapsed (top) and expanded (bottom)*

### To expand or collapse all stereo and multichannel regions:

- Press Alt (Windows) or Option (Macintosh) while clicking the triangle.

Individual items of an expanded-view stereo or multichannel region can be selected independently of the other associated regions in the Audio Regions List.

## Rules for Stereo and Multichannel Regions

For stereo and multichannel regions to be shown as collective regions, the component regions must be the same length. If an existing stereo or multichannel region has been dragged onto multiple mono tracks and edited such that one or more components are no longer the same length, the stereo display is removed and the regions are displayed as individual regions in the Regions List.

---

## Edit Modes

Pro Tools has four Edit modes: Shuffle, Spot, Slip, and Grid. (With Pro Tools 6.x, Grid mode provides two modes of operation: Relative and Absolute, explained below). The Edit mode is selected by clicking the corresponding button in the upper left of the Edit window.



*Edit mode buttons*

 You can also use F1 (Shuffle), F2 (Slip), F3 (Spot), and F4 (Grid) to set the Edit mode.

The Edit mode affects the movement and placement of audio and MIDI regions (and individual MIDI notes), how commands like Copy and Paste function, and also how the various edit tools (Trimmer, Selector, Grabber, and Pencil) work.

### Shuffle

In Shuffle mode, you can move, trim, cut, or paste regions freely within a track or to other tracks, but their movement is constrained by other regions. That is, if you place several regions in a track, they automatically snap to each other. You can then “shuffle” their order, but you cannot separate them from each other and you cannot make them overlap as in Slip mode. However, if there is silence between existing regions, and the regions are shuffled, the silence is maintained, and not removed.

In Shuffle mode, adding another region to the beginning of a track moves all subsequent regions to the right by the length of the region added.

When using the Trimmer in Shuffle mode, changing a region’s start or end point automatically moves the adjacent regions as necessary. The placement and insertion of MIDI notes is not affected by Shuffle mode.

### Slip

In Slip mode, regions can be moved freely within a track or to other tracks. In this mode, it is possible to place a region so that there is space between it and other regions in a track. When the track is played back, this space is silent. It is also possible to move a region so that it overlaps or completely covers another region.

Use Slip mode when you want the Trimmer, Selector, Grabber, and Pencil tools to work without any restrictions to placement in time.

### Spot

Use Spot mode to place regions at precise locations. In Spot mode you can specify a frame location (or a location based on any of the other time formats), capture an incoming Time Code address, or use a region’s time stamps as reference points for spotting. This can be particularly useful when performing post production tasks around SMPTE frame locations.

When Spot mode is enabled, Pro Tools asks you to specify a destination location when a region is dragged from either of the Regions Lists, or from a supported DigiBase browser.



## Grid

In Grid mode, regions and MIDI notes that are moved, trimmed or inserted “snap” to the currently selected grid value, or to precise increments on a user-definable time grid.

Grid mode can be applied in Absolute or Relative mode.

- ◆ In Absolute Grid mode, moving any region snaps the region start to Grid boundaries. If a region’s start point falls between beats, and the Grid is set to 1/4 notes, dragging the region will *snap* its start time to the nearest 1/4 note (the current absolute Grid value).
- ◆ In Relative Grid mode, regions can be moved by Grid (or Nudge) *units*. If a region’s start point falls between beats and the Grid is set to 1/4 notes, dragging the region will be constrained to 1/4 notes, preserving the region’s relative position to the nearest beat.

### To select Absolute or Relative Grid mode:

- Click the Grid mode selector and choose Absolute or Relative.

 *To temporarily suspend Grid mode and switch to Slip mode while dragging a region, hold down the Control key (Windows) or Command key (Macintosh).*

 *For more information on Relative Grid mode, see “Sliding Regions in Grid Mode” on page 274.*

### Configuring the Grid

The actual Grid size, chosen from the Grid Value pop-up can be based on a time value using the Main Time Scale; or, if Follow Main Time Scale is deselected, another time format can be used for the Grid size.

The Grid Value selector is located in the Edit window Options bar.

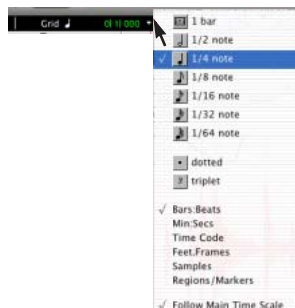

### Selecting the Grid Value

 *The current Grid value is also used for the Quantize Regions Command. For information, see “Quantizing Regions” on page 279.*

Also available in the Grid Value pop-up is an option for Regions/Markers. When selected, events can be placed freely (as in Slip mode) but will snap to region locations (start, end, and sync points), Markers, and Edit selections when placed near them.

 *MIDI notes inserted with the Pencil tool ignore the Regions/Markers option, and instead snap to the time value selected in the Grid Value pop-up menu.*

### To display the Grid lines in the Edit window:

- Choose Setups > Preferences > Display then enable Draw Grids in Edit Window.

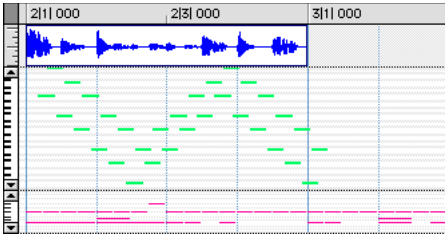

#### Turning on Grid lines from Edit Window

– or –

- Enable (and disable) Grid lines by clicking any Timebase Ruler Name.

Click for Grid lines

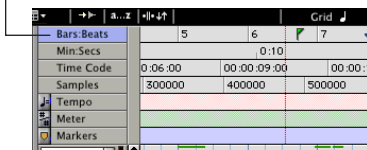

#### Turning on Grid lines from Ruler

For more information on Grid options, see “Sliding Regions” on page 271.

## Zooming

Zooming options in Pro Tools include the Horizontal and Vertical Zoom buttons, the Zoomer tool, the Zoom Preset buttons, and the Zoom Toggle command.

### Horizontal and Vertical Zoom Buttons

Use the Horizontal and Vertical Zoom buttons to zoom in and out on track data. Unlike the horizontal zoom value, the vertical zoom value for audio and MIDI tracks are independent, and therefore have separate buttons.

#### To zoom in horizontally for all tracks:



#### Horizontal Zoom button

- Click the right Horizontal Zoom button. To zoom out, click the other (left) Horizontal Zoom button.

– or –

- Press Control+] (Windows) or Command+] (Macintosh). To zoom out, press Control+[ (Windows) or Command+[ (Macintosh).

– or –

- Click and drag on the Horizontal Zoom button to zoom continuously.

### To zoom in vertically for all audio tracks:



#### *Vertical Zoom button (audio)*

- Click the (top) Vertical Zoom button with the audio waveform. To zoom out, click the bottom Vertical Zoom button.

– or –

- Press Control+Alt+] (Windows) or Command+Option+] (Macintosh). To zoom out, Control+Alt+[ (Windows) or press Command+Option+[ (Macintosh).

– or –

- Click and drag on the Vertical Zoom button to zoom continuously.

### To zoom in vertically for all MIDI tracks:



#### *Vertical Zoom button (MIDI)*

- Click the (top) Vertical Zoom button with the MIDI notes. To zoom out, click the bottom Vertical Zoom button.

– or –

- Press Control+Shift+] (Windows) or Command+Shift+] (Macintosh). To zoom out, press Control+Shift+[ (Windows) or Command+Shift+[ (Macintosh).

### To return to the previous zoom level:

- Alt-click (Windows) or Option-click (Macintosh) any of the Horizontal or Vertical Zoom buttons.

– or –

- Press Control+Alt+E (Windows) or Command+Option+E (Macintosh).

### To zoom in on a selection:

- Press Alt+F (Windows) or Option+F (Macintosh).

### To zoom so that all regions are visible in the Edit window:

- Double-click the Zoomer tool in the toolbar.

– or –

- Press Alt+A (Windows) or Option+A (Macintosh).

## Zoomer Tool

Use the Zoomer tool to zoom in and out around a particular area within a track. The Zoomer tool offers two modes: Normal, and Single Zoom mode.

- ◆ In Normal Zoom mode, the Zoomer tool remains selected after zooming.
- ◆ In Single Zoom mode, the previously selected tool is automatically reselected after zooming.

### Normal Zoomer Tool

#### To zoom around a certain track point:

**1** Click the Zoomer tool pop-up menu and select Normal Zoom mode.

– or –

Press the F5 key to toggle to Normal Zoom mode.



*Zoomer tool*

**2** Click once with the Zoomer at the point within the track. All tracks are zoomed in by one level and the Edit window is centered around the zoomed point.

**3** To zoom back to the previous level, Alt-click (Window) or Option-click (Macintosh) with the Zoomer.

#### To zoom into a particular track area:

**1** Click the Zoomer tool pop-up menu and select Normal Zoom mode.

– or –

Press the F5 key to toggle to Normal Zoom mode.

**2** To zoom horizontally, drag with the Zoomer in the track's playlist.

– or –

To zoom horizontally *and* vertically, press Control (Windows) or Command (Macintosh) while dragging in the track's playlist.

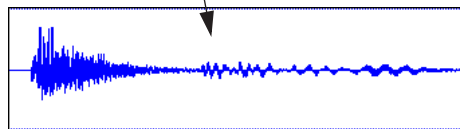
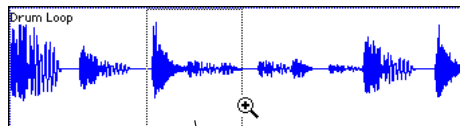

*Zooming horizontally with Zoomer tool*

The zoomed area fills the entire Edit window.

## Single Zoom Mode

Single Zoom mode returns you to the previously selected tool after a zoom has been performed.

For example, when using the Smart Tool you can click the Single Zoom tool, and once the Zoom operation has been performed, Pro Tools automatically switches back to the Smart Tool.

### To use Single Zoom mode:

- Click the Zoomer tool pop-up menu and select Single Zoom mode.
  - or –
- Press the F5 key to toggle to Single Zoom mode.

Single Zoom is identified with an arrow to the right of the Zoomer icon.



*Single Zoom mode*

Normal Zoom mode doesn't have the arrow.



*Normal Zoom mode*

## Zooming in the Ruler

### To zoom horizontally in the Ruler:

- 1 Press Control+Alt (Windows) or Command+Control (Macintosh) and move the cursor into the Ruler area, so the Zoomer appears.

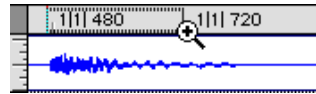

### Zooming in the Ruler

- 2 Click once to zoom in one level around a certain point.

– or –

Drag to zoom in around a particular Ruler range.

## Zoom Preset Buttons

Pro Tools lets you save up to 5 horizontal Edit window Zoom presets, which can be recalled by typing a number or by clicking a Zoom Preset button.

### To store a zoom preset:

- 1 Using either the Horizontal Zoom buttons or the Zoomer tool, navigate to the zoom level you want to store.
- 2 While pressing Control (Windows) or Command (Macintosh), click one of the five Zoom Preset buttons.



### Storing a zoom preset

The button flashes, indicating it is being written to, and then becomes selected.

**To recall a zoom preset, do one of the following:**

- Click the Zoom Preset button.
- While pressing the Start key (Windows) or Control (Macintosh), type the Zoom Preset's number on the alpha keyboard.
- With Commands Focus enabled, type the Zoom Preset's number on the alpha keyboard.

Horizontal zoom levels for all tracks are recalled.

 *Zoom settings can also be stored with Memory Locations. For details, see "Naming and Displaying Regions" on page 311.*

## Zoom Toggle

The Zoom Toggle command lets you zoom in and increase the current track's height and zoom level with one keystroke.

**To use Zoom Toggle:**

- 1 Make a selection on one or more tracks.
- 2 Press Start+E (Windows) or Control+E (Macintosh).

– or –

With Commands Focus enabled, press E.

The selection is zoomed to fill the Edit window, and the tracks containing the selection are set to a Track Height of Large. MIDI tracks automatically change to Notes view.

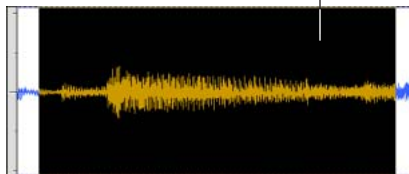
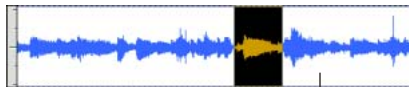

*Using the Zoom Toggle*

### Setting a Default Zoom Toggle Track Height

Zoom Toggle provides single-key toggling between the current track zoom setting and the default (Large) track height. You can change the default height for toggled tracks in the Display preferences.

**To set a default Zoom Toggle Track Height:**

- 1 Choose Setups > Preferences.
- 2 In the Display pane, select a default from the Zoom Toggle Track Height selector.

## Zooming with a Scroll Wheel

If you have a mouse with a scroll wheel, you can use the scroll wheel to zoom in and out of tracks, both vertically and horizontally.

### To zoom in and out horizontally in the Edit window:

- 1 Place the mouse over the tracks in the Edit window.
- 2 Alt-scroll (Windows) or Option-scroll (Macintosh) the scroll wheel up or down to zoom in or out horizontally.

### To zoom in and out vertically in the Edit window:

- 1 Place the mouse over the tracks in the Edit window.
- 2 Alt-Shift-scroll (Windows) or Option-Shift-scroll (Macintosh) the scroll wheel up or down to zoom tracks in or out vertically.

---

## The Universe Window

### (TDM Systems Only)

The Universe window displays an overview of the entire session, representing audio and MIDI material on all tracks that are not hidden (including tracks that are inactive, or that contain offline regions). The order in which material is displayed in the Universe window corresponds to the track order in the Edit window.

### To open the Universe window:

- Choose Windows > Show Universe.

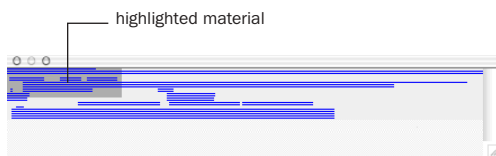

*Universe window*

Audio material residing in audio tracks is represented by a single, horizontal line in the Universe window. Each channel in a stereo or multichannel track is represented individually.

Since Auxiliary Input and Master Fader tracks do not contain audio, they are displayed as blank areas in the Universe window.

Similar to audio tracks, MIDI tracks containing note material are represented by single, horizontal lines.

## Resizing the Universe Window

Even though the Universe window can be resized horizontally and vertically, the length of the entire session is always displayed in the Universe window. If the Universe window is resized so some of the session's track are not displayed, a vertical scroll bar becomes available.

## Highlighted Material in the Universe Window

The highlighted, shaded area in the Universe window represents the material displayed in the Edit window. If you change what's displayed in the Edit window—by zooming, scrolling horizontally or vertically, hiding or unhiding tracks, or changing track heights—the highlighted area in the Universe window updates.

During playback, if the Edit window is set to scroll, the highlighted area in the Universe window also scrolls.

## Scrolling in the Universe Window

By clicking in the Universe window, you can automatically scroll, either horizontally or vertically, the material displayed in the Edit window. This provides a convenient method of locating anywhere in the session, or adjusting which shown tracks are visible in the Edit window.

To move the highlighted area in the Universe window:

- 1 Choose Windows > Show Universe.
- 2 To affect which tracks are displayed in the Edit window, click lower or higher (vertically) in the Universe window.

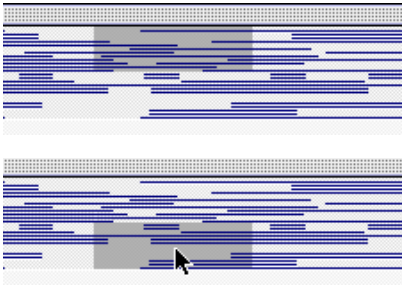

- 3 To scroll to a different session location, click later or lower (horizontally) in the Universe window.

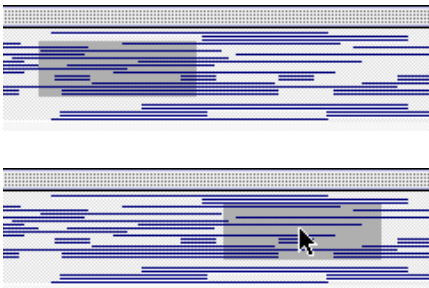

When all tracks are visible in the Edit window and the session is zoomed all the way out, with all regions visible, the entire Universe window is shaded.

## Timebase Rulers

Bars:Beats	1 1	1 2	1 3
Min:Secs	0:00.0	0:00.5	0:01.0
Timecode	00:00:00:00		00:00:01:00
Feet+Frames	0+00	1+00	2+00
Samples	0	20000	40000 60000
Tempo	Manual Tempo: 112.00		
Meter	Default: 4/4		
Markers	Marker 2		

All Rulers displayed

Any or all of the following Timebase Rulers can be displayed at the top of the Edit window:

- Bars:Beats
- Minutes:Seconds
- Time Code (All TDM systems and Pro Tools LE systems with DV Toolkit only)
- Feet+Frames (All TDM systems and Pro Tools LE systems with DV Toolkit only)
- Samples

In addition to providing a timing reference for track material, the Timebase Rulers are also used to define *Edit selections* for track material, and *Timeline selections* for record and play ranges.

 With the Selector, drag in any Timebase Ruler to select material across all tracks in the Edit window. To include the Conductor Tracks in the selection, press Alt (Windows) or Option (Macintosh) while dragging.

Any or all of the following Conductor Rulers can be displayed:

- Tempo
- Meter
- Markers

The Meter and Tempo Rulers indicate changes in meter and tempo within the Session. The Markers Ruler displays Markers to important track locations.



### To display all Rulers:

- Select Display > Ruler View Shows > All.

### To remove a Ruler from the display:

- Option-click the Ruler's name (to the left of the Ruler display).
  - or –
- Deselect the Ruler in Display > Ruler View Shows.

### To display only the Main Time Scale in the Ruler:

- Select Display > Ruler View Shows > None. (See “Main Time Scale” on page 233.)

### To add a specific Ruler to the display, such as the Markers Ruler, for instance:

- Select Display > Ruler View Shows > Markers.

### To change the display order for the Rulers:

- Click a Ruler's name and drag up or down to the new location.

## Ruler Options Pop-up Menu

The Ruler display options are also available from a pop-up menu.

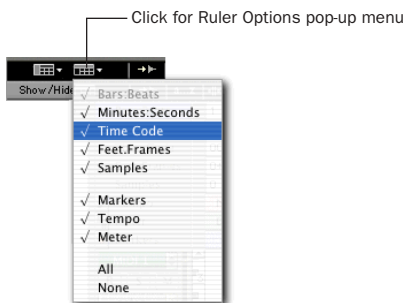

Ruler Options pop-up menu

## Main Time Scale

While all Timebase Rulers can simultaneously be displayed in the Edit window, there is only one that represents the *Main Time Scale*. The Main Time Scale determines the time format used for:

- The Transport's Main Counter
- Start, end, and length values
- Pre- and post-roll amounts
- Grid and Nudge values

The Main Time Scale can be set to the following formats:

**Bars:Beats** Displays the Time Scale in bars and beats. Use this Time Scale if you are working with musical material that must align with bars and beats.

To ensure your tracks align with the bars and beats in your session, make sure to record with the click (see “Recording with a Click” on page 151).

Material that is recorded without listening to the click can still be aligned to bar and beat boundaries in Pro Tools with the Identify Beat command (see “Identify Beat Command” on page 318).

**Minutes:Seconds** Displays the Time Scale in minutes and seconds. As you zoom in farther with the Zoomer, the Time Scale begins to display tenths, hundredths, and thousandths of a second.

**Time Code (All TDM Systems and Pro Tools Systems with DV Toolkit Only)** Displays the Time Scale in SMPTE frames. The Timecode Rate and Session Start time are set from the Session Setup window. (Pro Tools 6.4. In Pro Tools 6.2 and below, Timecode Rate is called Frame Rate.)

Pro Tools supports the following frame rates: 23.976, 24, 25, 29.97 Non-Drop, 29.97 Drop, 30 Non-Drop, and 30 Drop frames per second.

**Feet+Frames (All TDM Systems and LE Systems with DV Toolkit Only)** Displays the Time Scale in feet and frames for referencing audio-for-film projects. The Feet+Frames time display is based on the 35 millimeter film format.

The Redefine Current Feet+Frame Position command lets you define a Feet+Frame number for the current insertion point.

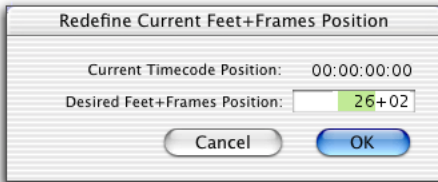

*Feet+Frames dialog*

**To set a relative frame position for a session:**

- Choose Setups > Redefine Current Feet+Frames Position and enter a Feet+Frame position to correspond to the timecode shown in the dialog.

**Samples** Displays the Time Scale in samples. This format is very useful for high-precision sample editing.

**Setting the Main Time Scale**

**To set the Main Time Scale:**

- Select a Time Scale at the bottom of the Display menu.
  - or –
  - Select from the Main Time Scale pop-up (also available in the Transport window, when it is set to display Counters).

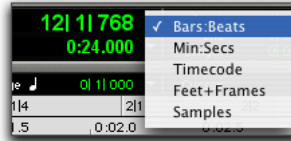

*Main Time Scale pop-up*

- or –
- If a Timebase Ruler is displayed, click its name so it becomes highlighted.

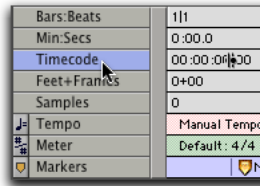

*Switching the Main Time Scale*

**Navigating with the Main Counter.**

The Main Counter (in the Main Time Scale pop-up or the Transport window) provides a convenient way to navigate to a specific time location.

**To navigate with the Main Counter:**

- 1 Click in the Main Counter.
- 2 Type in a location.
- 3 Press Enter (Windows) or Return (Macintosh) to automatically locate to a new location.

## Setting the Sub Time Scale

There is also a *Sub Location Indicator* displayed below the Main Location Indicator, and below the Transport's Main Counter, which provides an additional timing reference.

### To set the Time Scale for the Sub Location Indicator:

- Select from the Sub Time Scale pop-up next to the Location Indicator
  - or –
- Select from the Sub Time Scale pop-up in the Transport Window.

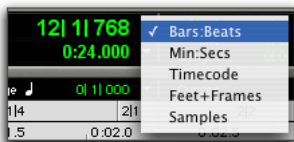

*Sub Time Scale pop-up*

---

## Tick-Based Timing

Pro Tools is a sample-based program with an internal MIDI resolution of 960,000 pulses per quarter note (ppq). However, when the Time Scale is set to Bars:Beats, the display resolution in Pro Tools is 960 ppq.

In Bars:Beats, Pro Tools is tick-based (960 ticks to a quarter note), which means that some amount of sample-rounding may occur when placing events at certain locations (see “Sample Rounding and Edit Operations” on page 236).

When working in Bars:Beats, you’ll often want to specify tick values for a number of operations, including:

- Placing and spotting regions
- Setting lengths for regions or MIDI notes
- Locating and setting play and record ranges (including pre- and post-roll)
- Specifying settings in the Quantize and Change Duration windows
- Setting the Grid and Nudge values

The following table lists the number of ticks for each of the main note sizes:

Note Value	Normal	Dotted	Triplet
1/2 note	1920	2880	1280
1/4 note	960	1440	640
1/8 note	480	720	320
1/16 note	240	360	160
1/32 note	120	180	80
1/64 note	60	90	40

## Ticks versus Samples

Audio material in Pro Tools is sample-based. This means that if an audio region is located at a particular sample (or SMPTE) location, it will not move from this location if the tempo changes in the session (though the audio region’s bar and beat location will change).

MIDI data in Pro Tools is tick-based. This means that if a MIDI region is located at a particular bar and beat location, it will not move from that location if the tempo changes in the session—though its sample location will change, thereby adjusting its relationship to audio.

When creating Markers and Selection Memory Locations, you can specify whether they have an Absolute (sample-based) or Bar|Beat (tick-based) reference. For more information, see “Bar|Beat and Absolute Reference” on page 325.

## **Sample Rounding and Edit Operations**

Because audio material in Pro Tools is sample-based, some amount of sample-rounding may occur with some edits when the Main Time Scale is set to Bars:Beats. This is most evident when you need audio regions to fall cleanly on the beat (as when looping) and notice that the material is sometimes a tick or two off. With a few simple precautions, this can be avoided.

When selecting audio regions to be copied, duplicated, or repeated, make sure to select the material with the Selector (enable Grid mode for precise selections), or set the selection range by typing in the start and end points in the Event Edit area. Do not select the material with the Grabber (or by double-clicking with the Selector). This ensures that the selection will be precise in terms of bars and beats (and not based on the length of the material in samples).

# Chapter 16: Playing and Selecting Track Material

## Playing Tracks

After recording or importing to tracks, you'll want to listen to the material to find track ranges that require editing, or material that can be turned into regions for use elsewhere.

To set where playback begins, you can click anywhere in a track with the Selector tool (as long as the Edit and Timeline selections are linked, see "Linking or Unlinking Edit and Timeline Selections" on page 245).

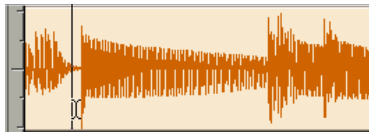

Setting a playback point with the Selector

Depending on the selected Scrolling Option, the *playback cursor*, a solid unblinking line, moves across the Edit window to indicate the current playback position. The playback location is displayed in the Counters in the Transport window, in the Big Time window, and also in the Location Indicators.



Transport with Counters displayed

The *edit cursor*, on the other hand, is a flashing line that appears when you click with the Selector in a track's playlist. The blinking edit cursor indicates the start point for any editing tasks performed. If you make a selection and perform an edit, the selection is the target of the edit.

The selected Scrolling Option determines how the Edit window scrolls during playback, and how the playback cursor functions. See "Scrolling Options" on page 241 for details.

### To begin playing from a specific point within a track:

- 1 Select Operations > Scrolling Options > No Auto Scrolling.
- 2 Make sure to select Operations > Link Edit and Timeline Selection.
- 3 With the Selector, click in the track where you want playback to begin.
- 4 Click Play in the Transport window to begin playback.
- 5 Click Stop in the Transport window to stop playback.



To jump to a different location and begin playing from there, click with the Selector at that point and click Play in the Transport window.

With the Edit and Timeline selections linked, you can click a region or MIDI note with the Grabber to automatically update the Timeline with the selection's start time, allowing you to easily play from that point.

## Page Scroll During Playback

You can set Pro Tools to scroll the track display while playing, and also have the edit cursor appear wherever playback stops.

### To make the track display and the edit cursor follow playback:

- 1 Select Operations > Scrolling Options > Page Scroll During Playback.
- 2 Choose Setups > Preferences. In the Operation page of the Preferences dialog, select the option for "Timeline Insertion Follows Playback," then click Done.  
 *Pressing Start+N (Windows) or Control+N (Macintosh) toggles Timeline Insertion Follows Playback.*
- 3 Make sure to select Operations > Link Edit and Timeline Selection.  
 *Pressing Shift+slash (/) toggles Link Edit and Timeline selection on and off.*
- 4 With the Selector, click in the track where you want playback to begin.
- 5 Click Play in the Transport window to begin playback. The playback cursor scrolls across the Edit window, indicating the current playback position.
- 6 Click Stop in the Transport window to stop playback. The edit cursor appears at the location where playback stops.

## Locating and Auditioning with Fast Forward/Rewind

You can use the Fast Forward and Rewind buttons in the Transport window to locate material in your tracks. If the Operation Preference for "Audio During Fast Forward/Rewind" is selected, you'll actually hear the scanned audio (similar to a CD player) when clicking the Fast Forward and Rewind buttons.

You can also fast forward or rewind incrementally by repeatedly clicking the appropriate button. The size of these increments is determined by the Main Time Scale:

- Bars:Beats: moves to the beginning of the previous or next bar.
- Min:Sec: moves back or forward in one-second steps.
- Time Code: moves back or forward in one-second steps (while adjusting for current SMPTE format).
- Feet+Frames: moves back or forward in one-foot steps.
- Samples: moves back or forward in one-second steps.

## Location Indicators

The Location Indicators, in the upper portion of the Edit window, display the current playback location. All Location Indicators (except the Sub Location Indicator) let you enter a location in their counter display to navigate to a specific time location.



Location Indicators

The Main Location Indicator displays the playback location in the time format for the Main Time Scale. The Sub Location Indicator can be set to any of the other Time Scale formats for another timing reference. Both the Main and Sub indicators also appear in the Transport window when it is set to display Counters.

#### To navigate with the Location Indicators:

1 Click in one of the Location Indicators.

– or –

Press asterisk (\*) on the numeric keypad to highlight the Main Location Indicator (or the Transport Counters or Big Time window, if either are displayed).

2 Type in the new location. Press period (.) to cycle through to the different time fields.

3 Press Enter to accept the new value and automatically locate there.



*Select the time format from the pop-up menus next to the Main and Sub indicators in either the Edit or Transport window.*

#### Scrolling in the Ruler

You can scroll the contents of the Edit window by clicking and dragging in the Ruler. While this doesn't actually update the session's Current Location, it does let you conveniently shift the display left or right for the sake of finding and editing material.

This method of scrolling is especially useful when using Continuous Scroll With Playhead (TDM systems only), which does not update or follow Timeline selections.

#### To scroll the entire contents of the Edit window from the Ruler:

- While pressing Control+Alt+Start (Windows) or Command+Option+Control (Macintosh), drag left or right in any of the Timebase Rulers.

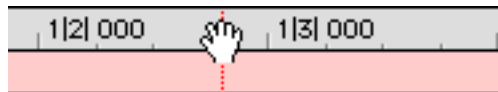

#### Scrolling in the Ruler

#### Scrolling with a Scroll Wheel

If you have a mouse with a scroll wheel, you can use the scroll wheel to scroll vertically or horizontally in any Pro Tools window that has a scroll bar (such as the MIDI Event List).

#### To scroll a Pro Tools window vertically:

1 Place the mouse over the window you want to scroll (for example, in the Edit window you might want to scroll either the track display or the Regions List).

2 Scroll the scroll wheel up or down to scroll the window up or down.

#### To scroll a Pro Tools window horizontally:

1 Place the mouse over the window you want to scroll (for example, in the Edit window you might want to scroll either the track display or the Regions List).

2 Shift-scroll the scroll wheel up or down to scroll the window to the left or right.

#### Locating the Playback Cursor

Use the Playback Cursor Locator to locate the playback cursor when it is off-screen. The Playback Cursor Locator will appear on the right edge of the Main Timebase Ruler if the playback cursor is located beyond the time visible in the

Edit window. If the playback cursor is located before the time visible in the Edit window, the Playback Cursor Locator will appear on the left edge of the Main Timebase Ruler.

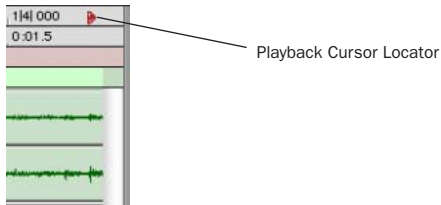

*Playback Cursor Locator, recording enabled (Playback Cursor located after currently viewed audio)*

The Playback Cursor Locator is red when a track is record enabled and blue when no track is record enabled.

For example, if the Scrolling Option is set to No Auto-Scrolling, the playback cursor will move off-screen after it has played past the time currently visible in the Edit window. The Playback Cursor Locator will appear on the right edge of the Main Timebase Ruler after the playback cursor moves beyond the time visible in the Edit window.

**To locate the playback cursor when it is off-screen:**

- Click the Playback Cursor Locator in the Main Timebase Ruler.

The Edit window will change to center the playback cursor on-screen.

---

## Auto-Scrolling Tracks in the Edit and Mix Windows

**(Pro Tools 6.2 and Higher on Pro Tools|HD Systems Only)**

If you are working with more tracks than can be displayed at one time in the Edit or Mix windows, you can select a track in one window and Pro Tools will automatically scroll to that track in the other window.

**To auto-scroll the Mix window to show a selected track in the Edit window:**

- In the Edit window, Start-click (Windows) or Control-click (Macintosh) the track name.

The track becomes selected, and the Mix window scrolls to display the selected track.

**To auto-scroll the Edit window to show a selected track in the Mix window:**

- In the Mix window, Start-click (Windows) or Control-click (Macintosh) the track name.

The track becomes selected, and the Edit window scrolls to display the selected track.

## Navigation using Track Position Numbers

**(Pro Tools 6.4 Only)**

Track Position Numbering assigns each track a number corresponding to its position in the Mix and Edit Windows. When tracks are reordered, track position numbers stay in numerical sequence. You can scroll directly to any track by its positional number.



**To navigate directly to any track using track position numbers:**

- 1 Choose Display > Display Track Position Numbers
- 2 Choose Operations > Go To Track Position Number  
– or –

Press Command+Option+G (Macintosh) or Control+Alt+G (Windows)

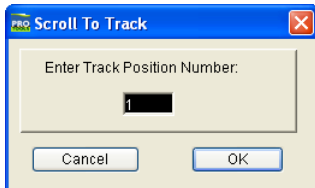

**Scroll To Track dialog**

- 3 In the Scroll To Track dialog, enter the track position number.
- 4 Click OK.

The track is selected, and the windows scroll as follows:

- The Edit window tracks scroll to bring the selected track as close to the top as possible.
- The Mix window tracks scroll to bring the selected track as close to the left as possible.

---

## Scrolling Options

Pro Tools offers the following options for how it scrolls the contents of the Edit window during playback and recording. Choose Operations > Scroll Options and select one of the following from the submenu:

**No Auto-Scrolling** The Edit window does not scroll during or after playback. The playback cursor moves across the Edit window, indicating the playback location.

**Scroll After Playback** The playback cursor moves across the Edit window, indicating the playback location. When playback has stopped, the Edit window scrolls to the final playback location.

**Page Scroll During Playback** The playback cursor moves across the Edit window, indicating the playback location. When the right edge of the Edit window is reached, its entire contents are scrolled, and the playback cursor continues moving from the left edge of the window.



*Making a selection in the Timeline or a playlist, or manually scrolling the Timeline while in Page Scroll or Continuous Scroll mode will suspend page scrolling. To resume page scrolling and jump to the current playback location, click the Playback Cursor Locator in the Main Timebase ruler (see “Locating the Playback Cursor” on page 239).*

## Continuous Scroll During Playback (TDM Systems Only)

This scrolling option causes the Edit window's contents to scroll continuously past the playback cursor, which remains in the center of the window. With this option, playback is always based on the Timeline selection (unlike Continuous Scroll With Playhead).

## Continuous Scroll With Playhead (TDM Systems Only)

This scrolling option causes the Edit window's contents to scroll continuously past the *Playhead*, which is a blue line in the center of the window (red when recording).

The Playhead indicates where playback begins when clicking Play in the Transport window.

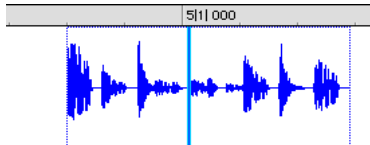

**Continuous Scroll With Playhead**

To move the Playhead to a particular location for playback, you can scroll there in the Ruler (see “Scrolling in the Ruler” on page 239), use the Edit window’s horizontal scroll bar, or type the location into one of the Location Indicators or one of the Counters.

Moving the Playhead with these methods does not update the Timeline selection. However, updating the Timeline selection automatically moves the Playhead to the Timeline insertion point.

With the Playhead enabled, you can jump to and play an Edit or Timeline selection. For details, see “Playing Edit and Timeline Selections with the Playhead” on page 258.

### Half-Screen Edit Window

When either Continuous Scroll During Playback or Continuous Scroll With Playhead is enabled, a half-screen appears at the far left of the Edit window (before the beginning of the session).

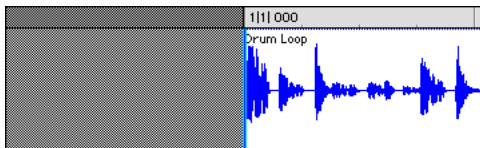

**Half-screen for Continuous Scroll With Playhead**

## The Scrubber

The Scrubber lets you “scrub” up to two tracks of audio in the Edit Window. Scrubbing is a technique that originated in tape editing, where the tape was rocked back and forth past the playhead at slower than normal speeds to find a particular location (usually for the sake of performing splices).

While viewing an audio waveform in Pro Tools can be helpful in visually finding an edit point, sometimes a waveform display (because of its sonic characteristics) may not reveal the desired spot in the audio material. By scrubbing back and forth over an edit point in Pro Tools, you can listen and zero in on the exact edit point you’re looking for.

When the Operation Preference for “Edit Insertion Follows Scrub/Shuttle” is enabled, the edit cursor automatically locates to the point where scrubbing stops.

When the Scrolling Option is set to Continuous Scroll During Playback or Continuous Scroll With Playhead, clicking with the Scrubber in a track’s playlist centers the Edit window around that point, and moves the Playhead there. With these Scrolling Options, scrubbed material moves past the Playhead, which remains stationary and centered.

 *Scrubbing is only supported for audio tracks. MIDI tracks cannot be scrubbed.*

### To scrub a single audio track:

- 1 With the Scrubber selected, drag within the track—left for reverse, right for forward.

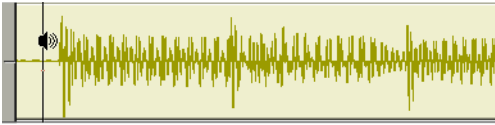

*Scrubbing an audio track with the Scrubber*

The distance and speed with which you drag (with either the mouse, or an external MIDI controller wheel) determine the length and speed of the scrubbed audio. Audio from the scrubbed track is routed to its output, along with any effects assigned to the track.

The resolution for the Scrubber is dependent upon the zoom factor for the scrubbed track.

 You can temporarily switch the Selector to the Scrubber by Right-clicking (Windows) or Control-clicking (Macintosh). For finer resolution, Control-Right-click (Windows) or Command-Control-click (Macintosh).

### To scrub multiple audio tracks:

- With the Scrubber selected, drag between two adjacent tracks.

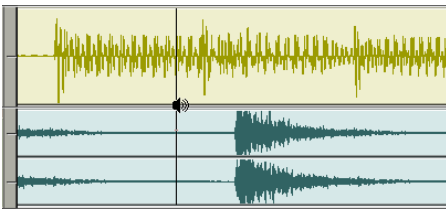

*Scrubbing between two audio tracks*

– or –

- Scrub within a selection that contains multiple tracks. Only the first two tracks are heard.

 The maximum number of channels scrubbed in Pro Tools is eight, which would allow you to scrub two stereo tracks (four channels), but not two 5.1 surround tracks (12 channels).

## Scrub/Shuttle Mode

When scrubbing normally, you can scrub at normal playback speeds or slower. Scrub/Shuttle mode, however, lets you scrub at several times normal speed, which is helpful in playing through large ranges and locating material.

### To scrub in Shuttle mode (at several times normal speed):

- 1 Select the Scrubber tool.
- 2 While pressing Alt (Windows) or Option (Macintosh), drag within the track—left for reverse, right for forward. The Fast Forward and Rewind buttons in the Transport window engage.

The distance and speed dragged determine the speed for the scrubbed audio.

## Shuttle Lock Mode

Shuttle Lock mode lets you use the numeric keypad to shuttle up to two tracks forward or backwards at specific speeds: 5 is normal speed, numbers from 6 up to 9 provide increasingly faster fast-forward speeds, and numbers from 4 down to 1 provide progressively faster rewind speeds (4 is the slowest rewind Shuttle Lock speed, 1 is the fastest). If multiple tracks are selected, only the first two tracks are shuttled.

### **To play one or two tracks with the shuttle lock:**

- 1 For TDM systems, make sure the Operation Preference for Numeric Keypad Mode is not set to Shuttle.
- 2 With the Selector, click in the track where you want playback to begin. To shuttle on two tracks, Shift-click in a second track.
- 3 Press the Start key (Windows) or Control (Macintosh) and a number on the numeric keypad: 0–9 (9 is fastest, 5 is normal speed, and 0 stops shuttling).

Once Shuttle Lock mode is initiated, Fast Forward and Rewind become highlighted in the Transport window.

- 4 Press additional keys to change the playback speed, or press Plus (+) or Minus (–) to switch the playback direction (plus for forward, minus for backward).

- 5 To stop playback, press Start+0 (Windows) or Control+0 (Macintosh).

### **To exit Shuttle Lock mode:**

- Press Stop in the Transport window.
  - or –
- Press the spacebar.

### **Custom Shuttle Lock Speed**

#### **(Pro Tools 6.2 and Higher on Pro Tools|HD Systems Only)**

Use the Custom Shuttle Lock Speed preference to customize the highest fast-for-ward Shuttle Lock speed (key 9) to better match your editing and auditioning needs.

### **To configure Custom Shuttle Lock Speed:**

- 1 In Pro Tools, select Setups > Preferences, and click the Operations tab.
- 2 Be sure that the Numeric Keypad mode is set to Transport or Classic.
- 3 Enter a desired percentage for the Custom Shuttle Lock Speed setting. The range for this setting is 50–800%. You can use the Up and Down Arrow keys to increase or decrease the setting.
- 4 Click OK.

The Custom Shuttle Lock Speed will be saved with your Pro Tools preferences (not with the session).

### **To enable Custom Shuttle Lock Speed:**

- Press Start+9 (Windows) or Control+ 9 (Macintosh) on the numeric keypad.

## **Numeric Keypad Set to Shuttle**

### **(TDM Systems Only)**

Pro Tools offers another form of shuttling, different from that of Shuttle Lock mode. With the Numeric Keypad Mode set to Shuttle, playback of the current Edit selection is triggered by pressing and holding the keys on the numeric keypad—playback stops once the keys are released. Various playback speeds are available in both forward and reverse. In this mode, pre- and post-roll are ignored.

### **To shuttle with the Numeric Keypad Mode set to Shuttle:**

- 1 Choose Setups > Preferences and click Operations.
- 2 Set the Numeric Keypad Mode to Shuttle and click Done.

3 With the Selector, click in the track where you want playback to begin. To shuttle on two tracks, Shift-click in a second track.

4 Press and hold any of the following keys (or key combinations) on the numeric keypad to trigger playback.

Shuttle Speed	Rewind Key	Forward Key
1 X Speed	4	6
4 X Speed	7	9
1/4 X Speed	1	3
1/2 X Speed	4+5	5+6
2 X Speed	7+8	8+9

5 Press a different key to switch the playback direction or speed. Release to stop.

## Linking or Unlinking Edit and Timeline Selections

Pro Tools lets you link or unlink the Edit and Timeline selections.

By default, the Edit and Timeline selections are linked. In this mode, selecting in a track's playlist (an Edit selection) also defines the play and record range (the Timeline selection).

Unlinking Edit and Timeline selections lets you make a selection within a track for editing purposes that is distinct from the selection in the Timeline (which determines the playback and recording range).

### To unlink the Edit and Timeline selections:

- Deselect Operations > Link Edit and Timeline Selection.
  - or –
  - In the upper left of the Edit window, click the Link Selection button so it becomes unhighlighted.



*Link Selection disabled and enabled*

If you are working with a film or video scene, you may want to unlink the Edit and Timeline selections to find or audition material that is at a different location than the current Timeline selection. Edit selections can be played (choose Operations > Play Edit Selection) without disrupting the current Timeline selection. Once you find the material, you can then go back to the Timeline selection and place it within the context of the scene.

Figure 12 illustrates another reason you'd want to unlink the Edit and Timeline selections. In this example, the Timeline selection sets a range to be looped on playback, while a MIDI region (residing within the loop) is selected for editing purposes. During playback, the Edit selection can be nudged, quantized, or transposed while the loop plays back completely independent and uninterrupted.

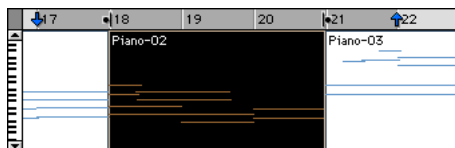

*Figure 12. Edit and Timeline selections unlinked*

While you could theoretically do this with the Edit and Timeline selections linked, as soon as playback is stopped, the playback range would then be updated to that of the more recent edit range.

## Playback/Edit Markers

Timeline selections are displayed in the Ruler with *Playback Markers*, which appear as blue arrows (red when recording). In addition, there are *Pre- and Post-Roll Flags* (which are green when enabled) indicating the location for pre- and post-roll.



*Playback Markers with Pre- and Post-Roll Flags*

When the Edit and Timeline selections are unlinked, Edit selections are displayed in the Ruler with *Edit Markers*, which appear as black brackets.



*Figure 13. Edit Markers*

If the Edit and Timeline selections are linked, Edit selections are represented by the blue Playback Markers.

See the following sections for details on working with Edit and Timeline selections:

- “Selecting Track Material” on page 246
- “Timeline Selections” on page 257
- “Setting Punch/Loop Points” on page 168
- “Setting Pre- and Post-Roll” on page 170

---

## Selecting Track Material

Before audio and MIDI material can be edited, it must first be selected. A track’s Display Format determines how the material is viewed and selected.

When you make a selection, it appears as a highlighted area of the tracks, and is also indicated by blue start and end arrows (*Playback Markers*) in the Ruler at the top of the Edit window. If any track (audio or MIDI) in the session is record-enabled, even if it is hidden, these markers appear red.

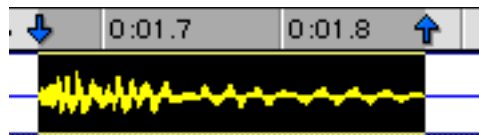

*Playback Markers indicating Edit selection*

If the Edit and Timeline selections are unlinked, the Edit selection range is indicated by Edit Markers in the Ruler. See “Linking or Unlinking Edit and Timeline Selections” on page 245 for details.

## Selections and Edit Groups

When making selections on tracks that are part of an Edit Group, all tracks within the group become selected.

## Selections and Hidden Tracks

When editing tracks that are part of an active Edit Group, any tracks within the group that are hidden are not affected by the edits. To edit all members of a group, make sure they are visible by highlighting their names in the Show/Hide Tracks List.

## Selections in Multiple Tracks

### To make a selection in multiple tracks:

- With the Selector, click and drag horizontally to include adjacent tracks in a selection (drag vertically to define the time range).

## Selecting Regions

### To select a portion of a region:

- With the Selector, drag within a region (left or right) to select the material on a single track. (You can also use the Selector across multiple, adjacent tracks to make multitrack selections.)

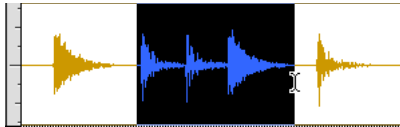

Selecting a portion of a region

### To select an entire region:

- Click the region with the Grabber.
  - or –
- Double-click the region with the Selector.

### To select two regions and the time range between them:

- 1 With the Grabber, click the first region.
- 2 Shift-click the second region. Both regions become selected, along with the time range between them (including any other regions).

### To select an entire track:

- Click in the track with the Selector and then choose Edit > Select All.
  - or –
- Triple-click in the track with the Selector.

### To select all regions in all tracks:

- 1 Select the “All” Edit Group in the Groups List.
- 2 Click in any track with the Selector and choose Edit > Select All.

– or –

Triple-click with the Selector in any track.



*Another way to select all regions in all tracks, without having to select the “All” Edit Group, is to press Enter (Windows) or Return (Macintosh), then type Control+A (Windows) or Command+A (Macintosh).*

## Region List Selection Follows Track Selection

When the Editing Preference for “Region List Selection Follows Track Selection” is enabled, selecting a region in a track also causes the region to become selected in the Audio or MIDI Regions List.

Conversely, if the Editing Preference for “Track Selection Follows Region List Selection” is enabled, selecting a region in the Audio or MIDI Regions List causes the initial occurrence of that region to become selected within the track.

## Selecting All from Timebase Rulers

### To select all material in all displayed audio and MIDI tracks:

- 1 Make sure the Edit and Timeline selections are linked.
- 2 Double-click in any Timebase Ruler. All regions in all displayed audio and MIDI tracks are selected. Tracks that are hidden are not selected.

### To select all material in all tracks, along with Conductor events:

- 1 Make sure the Edit and Timeline selections are linked.
- 2 While pressing Control (Windows) or Option (Macintosh), double-click in any Timebase Ruler. All regions in all displayed audio and MIDI tracks are selected, along with all events in each of the Conductor tracks.

### Making Selections While Playing

Pro Tools lets you make on-the-fly selections with the arrow keys.

#### To make a selection while playing:

- 1 Make sure to select Operations > Link Edit and Timeline selection.
- 2 With the Selector, click somewhere near the beginning of the track in which you want to make the selection.
- 3 Click Play in the Transport window to begin playback.
- 4 When playback reaches the point where you want the selection to begin, press the Down Arrow key.
- 5 Press the Up Arrow key at the point where you want the selection to end. The selected range becomes highlighted.
- 6 To stop playback, click Stop in the Transport window.

To automatically scroll to the beginning of the selection (or to the location of the on-screen cursor), press the Left Arrow key. To scroll to the end of the selection, press the Right Arrow key.

While in Page Scroll or Continuous Scroll mode, making a selection in the Timeline or a playlist during playback as the playback cursor moves off-screen will suspend page scrolling. To re-

sume page scrolling and jump to the current playback location, click the Playback Cursor Locator in the Main Timebase ruler (see “Locating the Playback Cursor” on page 239).

### Object Selections (TDM Systems Only)

You can use the Object Grabber to select non-contiguous regions on one or more tracks. Non-contiguous selections must encompass entire regions. If you want a non-contiguous selection to include a portion of a region, first turn the portion into a new region with the Separation Grabber (see “Separation Grabber” on page 263) or the Separate Region command (see “Separate Region Command” on page 262).

 *The Object Grabber is not available when the Edit mode is set to Shuffle or Spot.*

#### To select non-contiguous regions:

- 1 Make sure the Edit mode is set to either Slip or Grid.
- 2 Choose the Object Grabber from the Grabber tool pop-up menu.



*Object Grabber*

- 3 Shift-click each region you want to include in the selection. The regions can even reside on different tracks.

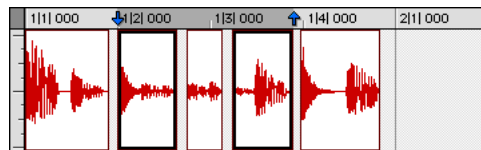

*Non-contiguous selection*

Each clicked region becomes surrounded by a dark rectangle, indicating it is selected.



The Object Grabber ignores Edit Groups when making selections. For instance, selecting a region on a grouped track does not cause regions in the other tracks in the group to become selected.

### Object to Time Selection (TDM Systems Only)

You can convert between Time- and Object-based selections. Time selections are made with the Selector and Time Grabber. Object selections are made with the Object Grabber.

Converting to an Object selection is useful when you are working with large selections, especially across multiple tracks, and you want to remove certain regions from the selection.

Converting to a Time selection is useful if you want to select all regions between a non-contiguous Object selection.

#### To change a Time selection to an Object selection:

- 1 Drag with the Selector in any track to define a selection. Select in a Timebase Ruler to select across all tracks.

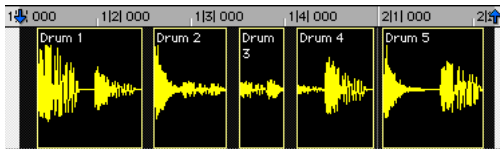

- 2 With the Object Grabber selected, double-click the Grabber icon in the toolbar. The regions falling within the selection range become selected as objects. Regions that were partially selected become deselected.

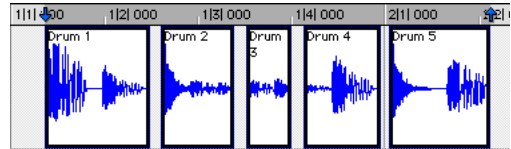

To select regions that were partially selected, press the Control key while double-clicking the Grabber icon.

#### To change an Object selection to a Time selection:

- 1 Select any number of regions with the Object Grabber.
- 2 Double-click the Selector icon in the toolbar. The time range between the first and last region becomes selected.

If using the Object Grabber (TDM systems only), regions on the other tracks in the group are selected if they fall within the range of the selected region.

## Changing a Selection Length

The selection range can be shortened or lengthened; this does not affect the material within the selection.

### To change the length of a selection:

- With the Selector, position the cursor over one end of the current selection and Shift-click or Shift-drag left or right.

– or –

- In the Ruler, drag the Playback Marker for the selection's start or end point.



*Dragging a Playback Marker*

– or –

- If the Edit and Timeline selections are unlinked, drag the Edit Markers (see Figure 13 on page 246) to change the selection length.

### To make a long-length selection:

- 1 With the Selector, click at the beginning of the selection.
- 2 Scroll to the end point of the selection and Shift-click at that point.

To verify the start and end points of a long selection, press the Left Arrow key to scroll to the beginning of the selection, or press the Right Arrow key to scroll to the end.

## Nudging a Selection Range

The selection range (not the material within the selection) can be moved by the Nudge value.

### To nudge a selection range:

- 1 Configure the Nudge value. For details, see “Defining the Nudge Value” on page 276.
- 2 Make the initial selection with the Selector.
- 3 While pressing Shift, press Plus (+) or Minus (-) on the numeric keypad to move the selection range by the Nudge value.

## Nudging Selection Start/End Points

Start and end points for selections can be moved by nudging them.

### To move a selection start or end point by the Nudge value:

- 1 Configure the Nudge value. For details, see “Defining the Nudge Value” on page 276.
- 2 Make the initial selection with the Selector.
- 3 While pressing Alt+Shift (Windows) or Option+Shift (Macintosh), press Plus (+) or Minus (-) on the numeric keypad to move the selection's start point by the Nudge value.

– or –

While Control+Shift (Windows) or pressing Command+Shift (Macintosh), press Plus (+) or Minus (-) on the numeric keypad to move the selection's end point by the Nudge value.

## Extending Selections

You can extend selections to region start and end points, to include an adjacent region, or to Markers and Memory Locations.

### To extend a selection to a region start or end point:

1 With the Selector, select a portion of a region, or click anywhere in the region.

2 Press Shift+Tab to extend the selection to the region's end point.

– or –

Press Shift+Control+Tab (Windows) or Shift+Option+Tab (Macintosh) to extend the selection to the region's start point.

### To extend a selection to include an adjacent region:

1 Select the first region with the Grabber.

2 Press Shift+Start+Tab (Windows) or Shift+Control+Tab (Macintosh) to extend the selection to include the next region.

– or –

Press Shift+Start+Control+Tab (Windows) or Shift+Control+Option+Tab (Macintosh) to extend the selection to include the previous region.

### To extend a selection to a Marker or Memory Location:

1 Click in a track with the Selector at the selection's start or end point.

– or –

Make a selection with the Selector or Grabber.

2 Shift-click a Marker in the Markers Ruler.

– or –

Shift-click a Memory Location in the Memory Locations window.

The selection is extended from the original Insertion point to the Marker or Memory Location.

## Using the Selection Indicators (Start, End, and Length)

The Selection Indicators at the top of the Edit window can define precise edit selections. Time values for the Selection Indicators use the time format for the Main Time Scale.



Start	0:15.000
End	0:15.000
Length	0:00.000

### Selection Indicators

#### To make a selection with the Selection Indicators:

1 Click with the Selector in the track you want to select.

2 Click in the Start field at the top of the Edit window.

3 Type in the start point for the selection and press the slash key to enter the value and automatically move to the end field.

4 Type in the end point for the selection and press Enter to accept the value.

## Numeric Entry Shortcuts for Selection Indicators

You can use the following shortcuts for entering values in the Selection Indicators:

- Press the slash key to cycle through the three Selection Indicators.
- Use period (.) or the Left and Right Arrow keys to move through the different time fields in each Selection Indicator.
- Press the Up or Down Arrow keys to increase or decrease the numerical values.
- Control-drag (Windows) or Command-drag (Macintosh) in a field to scroll to a new value.
- Press Plus (+) or Minus (–), along with an accompanying number, to add or subtract from the current field value.

For example, to add 10 to a current field value, cycle to the field, press the Plus (+) key, type “10” and then press Enter.

 *If using Calculator Entry mode with the Time Scale set to Bars:Beats, see “Calculator Entry Mode” on page 252.*

- Press Escape to exit the Selection Indicators without entering any values.

 *These shortcuts can also be used to enter start and end values in the Transport window.*

## Calculator Entry Mode

You can perform calculator-style editing of values in the Selection Indicators.

### To subtract time values:

- 1 In the Selection Indicator, highlight the time field you want to change.
- 2 Press Minus (–) on the numeric keypad.

- 3 Type the amount you want to subtract from the current time value, then press Enter.

- 4 Press Enter again to apply the change.

### To add time values:

- 1 In the Selection Indicator, highlight the time field you want to change.

- 2 Press Plus (+) on the numeric keypad.

- 3 Type the amount you want to add to the current time value, then press Enter.

- 4 Press Enter again to apply the change.

## Selecting Across Multiple Tracks

To perform edits across multiple tracks or all tracks, you must first select the tracks. Do this by making selections on tracks that are grouped (see “Grouping Tracks” on page 103), by including other tracks in the selection, or by selecting in a Timebase Ruler (for all tracks).

### To make a selection in multiple tracks:

With the Selector, click and drag vertically to include adjacent tracks in a selection (drag horizontally to define the time range).

### To extend a selection to another track:

- 1 Using the Selector or Grabber, make a selection in the first track or tracks.

- 2 Shift-click in additional tracks with the Selector. An identical range is selected for each additional track.

To shorten or lengthen the selection across each of the tracks, press Shift while dragging to change the range of the selection.

### To select across all tracks:

- Enable the *All* Edit Group and make a selection in any track.
  - or –
- Drag with the Selector in any Timebase Ruler (make sure the Edit and Timeline Selections are linked).

These selections include all tracks in the Edit window, but do not include the Conductor tracks (for Tempo, Meter, and Markers).

### To select across all tracks, including the Conductor tracks (for Tempo, Meter, and Markers):

- Alt-drag (Windows) or Option-drag (Macintosh) with the Selector in any Timebase Ruler.

## Moving and Extending Selections Between Tracks

With Commands Focus enabled, Edit selections can be moved or extended to adjacent tracks.

### To move a selection to an adjacent track:

- 1 Enable the Commands Focus by clicking its button in the upper left of the Edit window.



*Commands Focus button enabled*

- 2 With the Selector or Grabber, make a track selection.
- 3 Press P on your computer keyboard to move the selection to the previous track.

– or –

Press semicolon (;) to move the selection to the next track.

In either instance, the original Edit selection becomes deselected.

### To extend a selection to an adjacent track:

- 1 Enable the Commands Focus.
- 2 With the Selector or Grabber, make a track selection.
- 3 Press Shift+P to extend the selection to the previous track.

– or –

Press Shift+semicolon to extend the selection to the next track.

In either instance, the original Edit selection remains selected.

### To remove the bottom track from a selection:

- Press Start+Alt+semicolon (Windows) or Control+Option+semicolon (Macintosh) to remove the bottom track.

## Other Useful Selection Techniques

Following are some additional selection techniques.

### To position the edit cursor precisely at a region start, end, or sync point:

- 1 Make sure the Tab to Transients button is not enabled. (See “Tabbing to Transients” on page 254.)
- 2 Click with the Selector in the track.
- 3 Press Tab to move the cursor to the next region start, end, or sync point.

– or –

Press Control+Tab (Windows) or Option+Tab (Macintosh) to move the cursor to the previous region start, end, or sync point.

### To make a selection with the Scrubber:

- 1 Choose **Setup > Preferences**. In the **Operation** page of the **Preferences** dialog, select the option for “**Edit Insertion Follows Scrub/Shuttle,**” then click **Done**.
- 2 **Scrub** with the **Scrubber** to find an appropriate start point for the selection, then release.
- 3 While pressing **Shift**, scrub to an appropriate end point for the selection, then release. The range between the initial and final scrub becomes selected.

### To move a selection to an adjacent region on the same track:

- 1 Select a region with the **Grabber**.
- 2 Press **Start+Tab** (Windows) or **Control+Tab** (Macintosh) to move the selection to the next region.

– or –

Press **Start+Control+Tab** (Windows) or **Control+Option+Tab** (Macintosh) to move the selection to the previous region.

In either instance, the original region becomes deselected.

### To slide an Edit selection in the Ruler:

- 1 With the **Selector** or **Grabber**, make a track selection.
- 2 While pressing **Alt** (Windows) or **Option** (Macintosh), move the cursor over either of the **Playback Markers** in the **Ruler** (the **Grabber** appears).

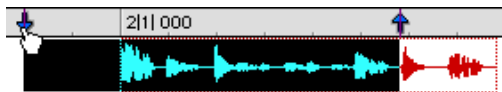

*Sliding an Edit selection in the Ruler*

- 3 Drag left or right to move the **Edit** selection back or forward in time, while preserving its length.

If the **Edit** and **Timeline** selections are unlinked, **Alt-drag** (Windows) or **Option-drag** (Macintosh) the **Edit Markers** instead.

## Tabbing to Transients

With the **Tab to Transients** button, you can automatically navigate to transients in audio waveforms, placing the cursor just before the detected transient peak. This allows you to easily define selections and play ranges, as well as start and end points for new regions, without having to zoom in on the waveform.



*Tab to Transients button enabled*

When **Tab to Transients** is enabled, the **Tabbing** function also locates the cursor to region start and end points, but not to sync points.

### To set the start and end points of a selection with Tab to Transients:

- 1 In the upper left of the **Edit** window, click the **Tab to Transients** button so it becomes selected.
- 2 If you will be setting the play range with this selection, selection **Operations > Link Edit and Timeline Selection**.
- 3 Click in the audio track just before the beginning of the material you want to select.
- 4 Press **Tab** repeatedly until the cursor locates to the transient at the start of the selection.

If necessary, you can move to the previous transient by pressing **Control+Tab** (Windows) or **Option+Tab** (Macintosh).

5 Press Shift+Tab until the cursor locates to the end of the material you want to select.

To move the selection end point to the previous transient, press Shift+Control+Tab (Windows) or Shift+Option+Tab (Macintosh).

Once selected, the material can be looped for recording or playback, or it can be turned into a new region with the Separate or Capture command.

 *Peak transients are usually visible in the waveform. However, some low-frequency transients may not appear as visible peaks in the waveform.*

---

## Playing Selections

Once an Edit selection is made, you can audition the track range by clicking Play in the Transport window. If enabled, the pre- and post-roll amounts play as well.

### To play a selection:

- 1 Make sure to select Operations > Link Edit and Timeline Selection.
- 2 With the Selector or Grabber, make a track selection.
- 3 If you want to use pre- or post-roll, enable and set the pre- and post-roll amounts. For details, see “Setting Pre- and Post-Roll” on page 170.
- 4 Click Play in the Transport window, or press the Space bar.

All tracks play for the range of the selection, including pre- and post-roll if enabled.

## Auditioning Pre- and Post-Roll

You can audition and play *just* the pre-roll or post-roll material for a selection.

### To play from the pre-roll point to the start of a selection, or to the current cursor location:

- Press Alt+Left Arrow (Windows) or Option+Left Arrow (Macintosh).

### To play to the post-roll point from the end of a selection, or from the current cursor location:

- Press Control+Right Arrow (Windows) or Command+Right Arrow (Macintosh).

## Auditioning Start and End Points for Selections

There may be times when you want to audition the start or end of a selection without hearing the entire selection. This allows you to check, for instance, whether the beginning or end of a selection includes any unwanted clicks or pops.

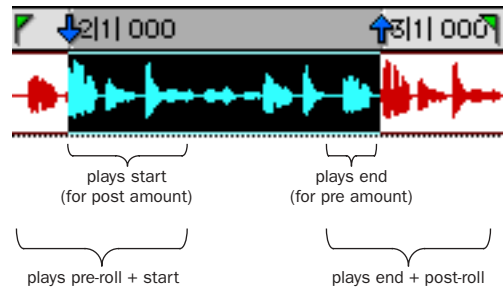

### Playback ranges for auditioning start/end points

#### To audition a selection start point:

- Press Control+Left Arrow (Windows) or Command+Left Arrow (Macintosh).

When auditioning the beginning of a selection, the selection plays from the start point for a duration equal to the post-roll amount.

#### To audition a selection start point with pre-roll:

- Press Control+Alt+Left Arrow (Windows) or Command+Option+Left Arrow (Macintosh).

#### To audition a selection end point:

- Press Alt+Right Arrow (Windows) or Option+Right Arrow (Macintosh).

When auditioning the end of a selection, playback begins before the end point by the pre-roll amount.

#### To audition a selection end point with post-roll:

- Press Control+Alt+Right Arrow (Windows) or Command+Option+Right Arrow (Macintosh).

## Looping Playback

When Loop Playback is enabled, the selected track range repeats on playback. If there is no selection, playback occurs normally from the current cursor location.

 *A selection must be at least 500 ms in length for it to loop on playback.*

Looping playback is a useful way to check the rhythmic continuity of a selection when working with musical material. If you're working with one-bar selections, you can loop playback to see if the material loops cleanly. If it seems to skip, you should then adjust the length of the selection until it works "musically" within the context of the playlist and the other tracks.

#### To loop playback of a selection:

- 1 Make sure to select Operations > Link Edit and Timeline Selection.
- 2 With the Selector, select the track range you want to loop.
- 3 Select Operations > Loop Playback. When enabled, a loop symbol appears in the Play button in the Transport window.



*Loop Playback enabled*

– or –

You can also enable Loop Playback by doing one of the following:

- Right-clicking (Windows) or Control-clicking (Macintosh) the Play button in the Transport window.
- With the Numeric Keypad Mode set to Transport, press 4 on the numeric keypad.

- 4 Click Play in the Transport window.

Playback begins from the pre-roll point (if enabled) and continues to the selection's end point, where it loops back to the start point.

- 5 Click Stop in the Transport window to stop playback.

## Loop Playback and Audio Recording

When Loop Playback is enabled, Pro Tools will not loop when attempting to record audio tracks with QuickPunch, Destructive Record, or Nondestructive Record mode.

To loop record audio tracks in Pro Tools, you must enable Loop Record mode. (See "Loop Recording Audio" on page 165.)



## Timeline Selections

With the Edit and Timeline selections unlinked, selections can be made in the Timeline that are distinct and separate from Edit selections.

With the Edit and Timeline selections linked, any Edit selections that are made are mirrored in the Timeline.

Whether the Edit and Timeline selections are linked or not, the range indicated by the Playback Markers always determines the range for playback and recording.

For TDM systems, when Continuous Scroll With Playhead is enabled, it determines where playback begins. For details, see “Playing Edit and Timeline Selections with the Playhead” on page 258.

### To make a Timeline selection with the Selector:

- 1 If you want to constrain the selection to the current grid value, set the Edit mode to Grid.
- 2 Drag with the Selector in any Timebase Ruler.

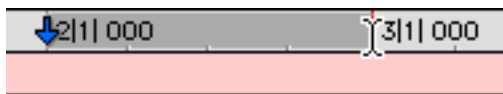

### Making a Timeline selection with the Selector

The Timeline selection is indicated in the Ruler by the blue Playback Markers (red if a track is record-enabled). The start, end, and length for the Timeline selection is displayed in the corresponding fields in the Transport window.

 To select all tracks, including Conductor tracks, press Alt (Windows) or Option (Macintosh) while dragging in a Timebase Ruler with the Selector.

### To set the Timeline selection by dragging the Playback Markers:

- 1 If you want to constrain movement to the current grid value, set the Edit mode to Grid.
- 2 With the Grabber, drag the first Playback Marker (down arrow) to set the start point.
- 3 Drag the other Playback Marker (up arrow) to set the end point.



### Dragging a Playback Marker

### To set the Timeline selection by typing into the Transport window:

- 1 If necessary, resize the Transport window by clicking in the upper right so the start and end times are displayed.
- 2 In the Transport window, click in the start field.  
– or –

Press Alt-slash (Windows) or Option-slash (Macintosh) to select the start field in the Transport window.

- 3 Type in the new start location and press slash to enter the value and automatically move to the end field.
- 4 Type in the new end location and press Enter to accept the value.

 Shortcuts for entering start and end values in the Transport window are listed in “Numeric Entry Shortcuts for Selection Indicators” on page 252.

## Sliding a Timeline Selection

Like Edit selections, Timeline selections can be slid in the Ruler.

### To move a Timeline selection in the Ruler:

- 1 While pressing Alt (Windows) or Option (Macintosh), move the cursor over either of the Playback Markers (the Grabber appears).
- 2 Drag left or right to move the Timeline selection back or forward in time, while preserving its length.

## Timeline Selections to/from Edit Selections

When the Edit and Timeline selections are unlinked, you can copy selections between them.

### To copy an Edit selection to the Timeline:

- Choose Operations > Copy Edit Selection to Timeline.

### To copy a Timeline selection to an Edit selection:

- Choose Operations > Copy Timeline Selection to Edit.

---

## Playing Edit and Timeline Selections with the Playhead

### (TDM Systems Only)

When Continuous Scroll With Playhead is enabled, selections in the Timeline do not determine when playback begins. The Playhead, itself, denotes where playback begins when clicking Play in the Transport.

The Edit and Timeline selections, however, can still be played when the Playhead is enabled.

### To play an Edit selection with the Playhead enabled:

- 1 Deselect Operations > Linked Edit and Timeline Selections.
- 2 Select Operations > Scroll Options > Continuous Scroll With Playhead.
- 3 With the Selector or Grabber, make a track selection.
- 4 Choose Operations > Play Edit Selection.

The Playhead jumps to the Edit selection and plays it from beginning to end, and then stops.

### To play a Timeline selection with the Playhead enabled:

- 1 Deselect Operations > Linked Edit and Timeline Selections.
- 2 Select Operations > Scroll Options > Continuous Scroll With Playhead.
- 3 Drag with the Selector in any Timebase Ruler to set the play range.
- 4 Choose Operations > Play Timeline Selection.

The Playhead jumps to the Timeline selection and plays it from beginning to end, and then stops.

## Moving the Playhead

When Continuous Scroll With Playhead is enabled, the Playhead can be moved forward or back to the next region boundary in the selected track.

### **To move the Playhead through a track's region boundaries:**

- 1** Make sure the Tab to Transients button is not enabled. (See “Tabbing to Transients” on page 254.)
- 2** Click in the track with the Selector.
- 3** Press Tab to move the Playhead forward to the next region boundary.

– or –

Press Control+Tab (Windows) or Option+Tab (Macintosh) to move the Playhead back to the previous region boundary.



# Chapter 17: Working with Regions and Selections

Because regions are the basic building block of audio and MIDI tracks, understanding how they are created, edited, and arranged is essential to taking full advantage of the editing capabilities of Pro Tools.

This chapter covers basic editing functions as they apply to regions and selections. The material, for the most part, applies to both MIDI and audio data.

For editing procedures more specific to MIDI, see Chapter 23, “MIDI Editing.” For more advanced editing procedures, see Chapter 18, “Advanced Editing (TDM Systems Only).” You should, however, become familiar with the information in this chapter before moving on to the others.

---

## Creating New Regions

Pro Tools provides you with several commands for creating regions, each of them having a slightly different effect on the selection. When you create a new region, it appears in the Regions List and in the track’s playlist. For details on how these new regions are automatically named, see “Auto-Naming Options” on page 312.

When creating a new region from an existing region, the original region remains in the Regions List.

## Capture Region Command

The Capture Region command defines a selection as a new region and adds it to the Regions List. From there, the new region can be dragged to any existing tracks.

### To capture a new region:

- 1 With the Selector, drag within an existing region to select the material for the new region.

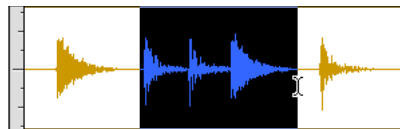

*Selecting a region portion*

- 2 Choose Edit > Capture Region.
- 3 Enter a name for the new region and click OK.

The new region appears in the Regions List. The selected region portion remains intact and unchanged.

## Separate Region Command

The Separate Region command defines a selection within an existing region, or a partially selected region, as a new region and separates it from adjacent material. If there is no selection and the Edit cursor is placed within the region, the region is split at the insertion point.

### Auto-Name Separated Regions

With the Auto-Name Separated Regions option in the Editing Preferences selected, Pro Tools automatically names separated regions for you. The name is a numbered variation of the original region's name.

#### To separate one or more regions:

- 1 With the Selector, drag to select the material for the new region or regions. The selection can reside within a single region, across adjacent regions within the same track, or across multiple tracks.

– or –

Click with the Selector at the point within a region, where you want to split the region in two.

- 2 Choose Edit > Separate Region.

– or –

Press Command+E (Windows) or Control+E (Macintosh).

- 3 If the Editing Preference for Auto-Name Separated Regions is disabled, enter a name for the new region when prompted, then click OK.

The new regions appear in the tracks in which they were created, separate from the data surrounding it. They also appear in the Regions List. From there they can be dragged to other tracks.

By separating a region, additional regions are auto-created from data on either side of the separation, which have new numbers assigned to their names. The original region remains intact and unchanged on the Regions List.

 If the Editing Preference for “Separate Region Operates On All Related Takes” is selected and you are editing a region that is one of a number of related takes with the same User Time Stamp (for example, as created with loop recording), the Separate Region command affects each take. For details see, “Editing Preferences for Takes” on page 167.

## Separating Multiple Tracks

Figure 14 illustrates a separation across three mono audio tracks and one stereo track. For some tracks, the selection resides within a region, while others reside at the start or end of a region.

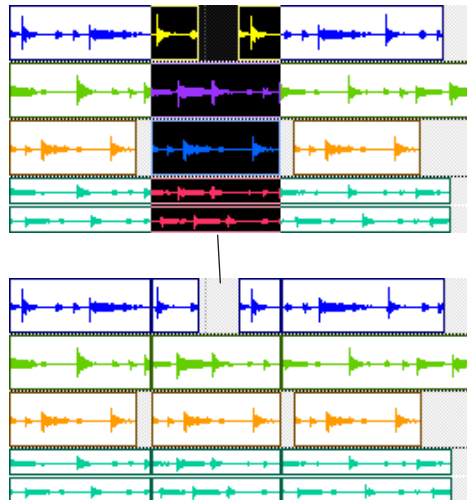

Figure 14. Separating across multiple tracks

Once separated, this material can be easily moved or copied to another location.

## Separation Grabber

You can use the Separation Grabber to automatically separate an edit selection and move it to another location or another track.

### To separate a selection with the Separation Grabber:

- 1 With the Selector, drag to select the material for the new region or regions. The selection can reside within a single region, across adjacent regions within the same track, or across multiple tracks.
- 2 From the Grabber pop-up menu, choose the Separation Grabber.



### Separation Grabber

- 3 Drag the selection to the new location, or to another track.

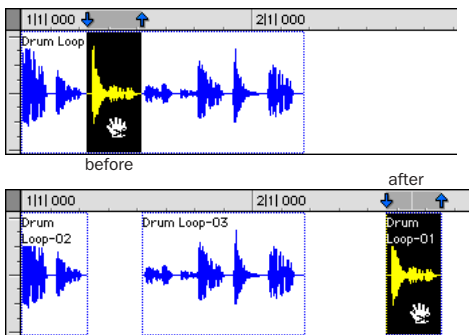

*Dragging later in track with Separation Grabber*

A new region (or regions) containing the previous selection is created, separate from the original selection. New regions are also created from the material outside the original selection.

**To separate a selection without affecting the original regions:**

- 1 With the Selector, drag to select the material for the new region or regions. The selection can reside within a single region, across adjacent regions within the same track, or across multiple tracks.
- 2 From the Grabber pop-up, choose the Separation Grabber.
- 3 While pressing Alt (Windows) or Option (Macintosh), drag the selection to the new location, or to another track.

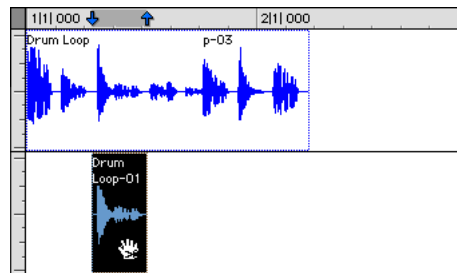

*Dragging to another track with Separation Grabber*

New regions containing the previous selection are created and placed at the new location. The original selection and regions remain intact.

## Trim To Selection Command

The Trim To Selection command removes data before and after a region or MIDI note selection, leaving only the selection. This command provides a handy means of quickly removing all data in a region (and in some instances the entire track) except for the current selection.

**To trim unwanted data from a region or note:**

- 1 With the Selector, select a portion of a region or note (or a range of notes).
- 2 Choose Edit > Trim > To Selection to remove material outside of the selection.

---

## Healing a Separation

The Heal Separation command returns separated regions to their original state—provided the regions are still next to each other and their relative start/end points haven't changed since the separation.

If you have trimmed or otherwise changed the start or end points of the two regions, or moved them further away from each other, you won't be able to repair them with the Heal Separation command. It is not possible to heal two regions created from different audio files.

### To heal a separation between two regions:

- 1 With the Selector, make a selection that includes part of the first region, the entire separation between the regions, and part of the second region.
- 2 Choose Edit > Heal Separation.

If the regions won't heal, there are other ways to return the separated regions to a single region.

◆ Delete one of the two separated regions (make sure you're in Slip mode so the gap doesn't close) and use the Trimmer to expand the remaining region to its original length. For information on using the Trimmer, see "The Trimmer Tool" on page 267.

– or –

◆ Delete both of the separated regions and drag the original region from the Regions List to the original location. For information on placing regions, see "Placing Regions in Tracks" on page 264.

---

## Placing Regions in Tracks

Once you have created a region, it appears in the Audio or MIDI Regions List. From there you can drag it to a track to add to an existing arrangement of regions, or you can create a new track and start adding regions from scratch. The exact placement of regions in a track depends on whether the Edit mode is set to Shuffle, Slip, Spot, or Grid (see "Edit Modes" on page 224 for details).

For information on locating regions in the Regions List by typing the first few letters of their name, see "Keyboard Selection of Regions" on page 223.

### To place a region in a track:

- 1 In the Audio or MIDI Regions List, select the region or regions you want to place.
- 2 Drag the selected regions from the Regions List to a location in a track.

If dragging multiple regions, the regions are placed on adjacent tracks. If dragging a stereo region, it must be placed in a stereo track or in two mono tracks.

Regions are placed according to the current Edit mode:

- In Shuffle mode, existing track regions are slid as necessary to make room for the new region.
- In Spot mode, you are prompted by the Spot dialog to enter a location for the dragged region (see "Spotting Regions" on page 273).
- In Grid mode, the dragged region snaps to the nearest Grid boundary.



*In Pro Tools 6.x, you can temporarily disable Grid mode while dragging a region by holding down the Control key (Windows) or Command key (Macintosh).*



- In Slip mode, the regions are placed freely anywhere in the destination track.

 Use the *Replace Region* function to replace all occurrences of a region (in all tracks) with a different region from the *Regions List*. See “*Replacing Audio Regions*” on page 291.

## Defining Region Sync Points

The placement of regions in Grid and Spot mode can be based on the definition of a region sync point. Sync points are used when a point within a region must be aligned to the Grid or to a particular SMPTE or bar/beat location. This capability is important in placing music and sound effects for film and video work.

For example, suppose you had an audio region for a door slam that included the creak of the door closing, the actual slam, and the reverb of the slam. You may want to align the “slam” to other locations within the session.

### To define a region sync point:

- 1 Set the Edit mode to Slip by clicking its button in the upper left of the Edit window.
- 2 Click with the Selector at the point in the region, usually the peak of the waveform, where you want to define the sync point.
- 3 Choose Edit > Identify Sync Point. A small down arrow appears at the bottom of the region, indicating the location of the sync point.

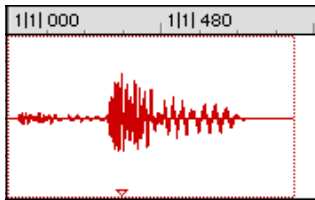

*Sync point defined*

### To remove a sync point:

- Select the entire region and choose Edit > Remove Sync Point.

### To change the location of a sync point:

- Click with the Selector at a point in a region and choose Edit > Identify Sync Point. The new location is identified as the sync point for the region.

## Placing Regions at the Edit Insertion Point

You can place and align a region’s start, end, or sync point to the Edit insertion point. This technique is useful in post production applications since it allows you to set a reference point and quickly place sound effects while ensuring that their start point remains consistent.

You can drag a region from the same track, from another track, or from the Audio or MIDI Regions List.

 For TDM systems, when *Continuous Scroll with Playhead* is selected, regions snap to the playhead, instead of the Edit insertion point.

### To place the start of a region at the Edit insertion point:

- 1 Click with the Selector in the track at the time location where you want to place the start of the region.

**2** While pressing the Start key (Windows) or Control (Macintosh), drag the region from the Regions List, or from another track, to the destination track.

– or –

If the region is already in the track, Start-click (Windows) or Control-click (Macintosh) the region with the Grabber.

**To place the end of a region at the Edit insertion point:**

**1** Click with the Selector in the track at the time location where you want to place the end of the region.

**2** While pressing Control+Start (Windows) or Command+Control (Macintosh), drag the region from the Regions List, or from another track, to the destination track.

– or –

If the region is already in the track, Control-Start-click (Windows) or Command-Control-click (Macintosh) the region with the Grabber.

**To place the sync point of a region at the Edit insertion point:**

**1** Click with the Selector in the track at the time location where you want to place the sync point of the region.

**2** While pressing Shift+Start (Windows) or Shift+Control (Macintosh), drag the region from the Regions List, or from another track, to the destination track.

– or –

If the region is already in the track, Shift-Start-click (Windows) or Shift-Control-click (Macintosh) the region with the Grabber.

## Aligning to Region Start Points

The start, end, and sync point of one region can be aligned to the start of a different region on another track.



*For TDM systems, if Continuous Scroll with Playhead is enabled, region start, end, and sync points align to the playhead.*

**To align the start points of regions on different tracks:**

**1** With the Grabber, select the region you want to align to by clicking it.

**2** For TDM systems, if Continuous Scroll with Playhead is enabled, move the playhead to the start of the selected region. For details, see “Moving the Playhead” on page 259.

**3** With the Grabber, Start-click (Windows) or Control-click (Macintosh) the region you want to move.

– or –

Start-drag (Windows) or Control-drag (Macintosh) a region from the Regions List to another track.

The start point of the second region is aligned to the start of the first region.

**To align the end point of a region to the start of another region (on a different track):**

**1** With the Grabber, select the region you want to align to by clicking it.

**2** For TDM systems, if Continuous Scroll with Playhead is enabled, move the playhead to the start of the selected region. For details, see “Moving the Playhead” on page 259.

**3** With the Grabber, Control-Start-click (Windows) or Command-Control-click (Macintosh) the region you want to move.

– or –

Control-Start-drag (Windows) or Command-Control-drag (Macintosh) a region from the Regions List to another track.

The end point of the second region is aligned to the start of the first region.

**To align the sync point of a region to the start of another region (on a different track):**

**1** With the Grabber, select the region you want to align to by clicking it.

**2** For TDM systems, if Continuous Scroll with Playhead is enabled, move the playhead to the start of the selected region. For details, see “Moving the Playhead” on page 259.

**3** With the Grabber, Shift-Start-click (Windows) or Shift-Control-click (Macintosh) the region you want to move.

– or –

Shift-Start-drag (Windows) or Shift-Control-drag (Macintosh) a region from the Regions List to another track.

The sync point of the second region is aligned to the start of the first region.

---

## The Trimmer Tool

The Trimmer tool provides region, note, and data trimming functions.

Pro Tools TDM systems provide three Trimmers, including the Standard, Time, and Scrub Trimmer. Pro Tools LE provides the Standard and Time Trimmers.

The Trimmer is constrained by boundary regions, regardless of the current Edit mode, as follows:

- Trimming towards the left is constrained by the adjacent region's left-most boundary (region start).
- Trimming towards the right is constrained by the region's right-most boundary (region end).

### Standard Trimmer

With the Trimmer tool, you can quickly shorten or expand a region (up to the entire length of the source audio file). The first time you trim a region, Pro Tools automatically adds it to the Regions List as a new region (with a name derived from the original) in order to differentiate it from the original.

The Standard Trimmer is a nondestructive tool and doesn't actually modify the original audio or MIDI data (when working on regions). To return to the length of the original region, drag it from the Regions List, or resize the edited region with the Trimmer to its original length.

Use of the Trimmer is affected by the current Edit mode: Shuffle, Slip, Spot, or Grid. See “Edit Modes” on page 224 for more information.

 *The Standard Trimmer can also be used to lengthen and shorten MIDI notes (see “Trimming Note Start and End Times” on page 361), and also to scale automation and controller data up or down “Drawing Automation” on page 465.*

 *For TDM systems, the Trimmer has three modes: Standard Trimmer (discussed in this section), Scrub Trimmer (see “The Scrub Trimmer” on page 270), and Time Trimmer (see “The Time Trimmer” on page 268).*

#### To trim a region with Standard Trimmer:

1 Select the Trimmer tool. For TDM systems, make sure the Standard Trimmer is selected in the Trimmer pop-up menu.



*Standard Trimmer*

2 Move the cursor near the start or end of the region, so the Trim cursor appears.



*Trim cursor*

To reverse the direction of the Trim cursor, press Alt (Windows) or Option (Macintosh).

3 If trimming the end, drag left to shorten the region, right to lengthen.

– or –

If trimming the start, drag right to shorten the region, left to lengthen.

 *When working with audio, you cannot trim past adjacent regions.*

When trimming regions in a stereo or multi-channel track, all channels are trimmed.

When using Shuffle mode, adjacent regions are slid as necessary to make room for the edited region. If using Grid mode, the dragged start/end times snap to the nearest Grid boundary. If using Spot mode, the Spot dialog opens, where you can enter the new location for the region’s start or end point.

## The Time Trimmer

The Time Trimmer is a convenient tool for matching an audio region to the length of another region, a tempo grid, a video scene, or to practically any other reference point you want.



*Time Trimmer over a region*

The Time Trimmer works by using the Time Compression/Expansion (TC/E) AudioSuite plug-in (or a third party plug-in) to create a new audio file. You use the Time Trimmer by dragging the region’s start or end point to expand or compress the region.

## Time Compression/Expansion Plug-In Preferences

You can select settings for the Time Compression/Expansion AudioSuite plug-in by choosing from the Default Settings pop-up list in the Processing Preferences, under “TC/E.” The settings available are presets included with Pro Tools; in addition, if you save your own presets for the Time Compression/Expansion plug-in, they will also appear here.

 Refer to the *DigiRack Plug-Ins Guide* for more information about AudioSuite plug-ins.

## Using the Time Trimmer in Grid Mode

The Time Trimmer can be used in Grid mode to match a region to the tempo of a session or a section of a session. For example, you might import a one-bar drum loop with a tempo of 90 BPM into a session with a tempo of 120 BPM. In Grid mode, you can use the Time Trimmer to simply and quickly “time compress” the drum loop to the length of one measure, with minimal loss of audio fidelity.

 *In Pro Tools 6.x, trimming regions while in Relative Grid mode will trim the regions in grid increments while maintaining their relative offset (if any) from the grid.*

### To use the Time Trimmer in Grid mode:

- 1 Set the Edit mode to Grid.
- 2 Select “TCE Trimmer” from the Trimmer pop-up menu.



Trimmer set to TCE

3 With the Time Trimmer, drag the region’s start or end point to compress or expand the region to the Grid (for example, by quarter notes). The region is automatically processed using the Time Compression/Expansion AudioSuite plug-in. The new region appears in the playlist and in the Regions List.

## Using the Time Trimmer in Slip Mode

### To use the Time Trimmer in Slip mode:

- 1 Set the Edit mode to Slip.
- 2 Select “TCE Trimmer” from the Trimmer pop-up menu.
- 3 With the Time Trimmer, drag the region’s start or end point to compress or expand the region freely. A new region is automatically processed using the Time Compression/Expansion AudioSuite plug-in. The new region appears in the playlist and in the Regions List.

## Using the Time Trimmer in Spot Mode

In Spot mode, clicking with the Time trimmer in a region opens the Spot Dialog. You can specify the location you want the region to start or end at, or the duration of the region, and the region is automatically compressed or expanded as specified.

### To use the Time Trimmer in Spot mode:

- 1 Set the Edit mode to Spot.
- 2 Select “TCE Trimmer” from the Trimmer pop-up menu.

**3** Click the region near its start or end point. The Spot Dialog opens. Using any Time Scale, enter a new start or end time (or duration) for the region, then click OK. A new region is automatically processed using the Time Compression/Expansion AudioSuite plug-in. The new region appears in the playlist and in the Regions List.

## The Scrub Trimmer (TDM Systems Only)

The Scrub Trimmer is a convenient tool for auditioning material (on up to two tracks) to find a trim point. You can drag in a track to hear the audio information, then trim at a specific location by releasing the mouse button.

This action creates a new region. Note that the cursor changes into a “right trim” or “left trim” shape as it is placed over the right or left side of a region. To reverse the direction of the Scrub Trimmer, press Alt (Windows) or Option (Macintosh) before you click the region.

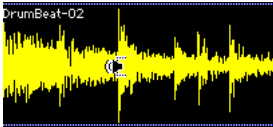

*Scrub Trimmer over a region*

Scrub playback speed and direction vary with controller movement. Scrubbed audio is routed through the track signal path, so you hear any effects in the signal path.

### To scrub trim a track:

- 1** Click the Scrub Trimmer tool. The cursor changes to a speaker with a bracket.
- 2** Drag within a track to the left or right. Audio from a scrubbed track is routed through the track signal path, including any TDM effects. When you locate the trim point, release the mouse button to trim the region.

To scrub trim two tracks, click with the Scrub Trimmer between two adjacent tracks and drag.

To scrub with finer resolution (without having to zoom in), press Control (Windows) or Command (Macintosh) while scrubbing.

## Trim To Insertion Command

You can trim a region or MIDI note by automatically removing the material between the Edit insertion point and the start or end point.

### To trim from a start point to insertion:

- 1** With the Selector, click inside the region or note where you want the new start point to be.
- 2** Choose Edit > Trim > Start To Insertion. The region’s start point is automatically trimmed to the insertion point.

### To trim from an end point to insertion:

- 1 With the Selector, click inside the region or note where you want the new end point to be.
- 2 Choose Edit > Trim > End To Insertion. The region's end point is automatically trimmed to the insertion point.

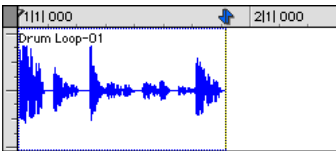
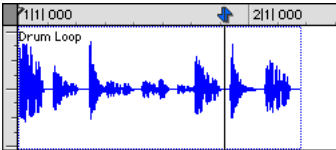

Region end trimmed to insertion

## Trimming with Nudge

You can trim the start and end points of a region by nudging them.

### To trim a region's start or end point by the Nudge value:

- 1 Configure the Nudge value. For details, see “Defining the Nudge Value” on page 276.
- 2 With the Grabber, select the region you want to trim.
- 3 While pressing Alt (Windows) or Option (Macintosh), press Plus or Minus on the numeric keypad to trim the region's start point by the Nudge value.

– or –

While pressing Control (Windows) or Command (Macintosh), press Plus or Minus on the numeric keypad to trim the region's end point by the Nudge value.

## Sliding Regions

A region or group of selected regions (on the same track or on multiple tracks) can be slid with the Grabber tool to new locations or to other tracks. This feature is useful in music and post production applications where the timing of audio events such as sound effects and dialog need to be spotted to music, film, or video.

Sliding regions is affected by whether the current Edit mode is set to Shuffle, Slip, Spot, or Grid. See “Edit Modes” on page 224 for details.

 You can slide a copy of a region to another location or track by pressing Alt (Windows) or Option (Macintosh) while dragging.

 To retain a region's location when dragging to another track, press the Start key (Windows) or Control (Macintosh) while dragging.

## Shuffling Regions

In Shuffle mode, you can move regions freely within a track or onto another track, but their movement is constrained by other regions. That is, if you place several regions in a track, their start and end points automatically snap to each other. You can then “shuffle” their order, but you cannot separate them from each other and you cannot make them overlap as in Slip mode. In Shuffle mode, adding another region to the beginning of a track moves all subsequent regions to the right by the length of the region added.

### To shuffle regions:

- 1 Set the Edit mode to Shuffle by clicking its button in the upper left of the Edit window.
- 2 Drag a mono region from the Regions List to an empty track. The region snaps to the beginning of the track.
- 3 Drag a second region from the Regions List to the same track, somewhere in the middle. The start point for the second region snaps to the end of the first region.
- 4 With the Grabber, drag the second region to the beginning of the track.

Pro Tools “shuffles” the position of the two regions. The second region now occurs first, yet the two still cling together.

- 5 Experiment more with Shuffle mode by dragging additional regions to the track and rearranging them.

Locked regions (see “Locking Regions” on page 279), and all regions occurring after the locked region, are not displaced when other neighboring regions are moved in Shuffle mode. If there is not enough room to place or duplicate a region in front of a locked region, the insertion area is disabled.

If you place a region while in Slip mode and switch to Shuffle mode, Pro Tools preserves the relative timing and position of the slipped region, and any blank space between it and other regions.

## Shuffling Multiple Tracks and Multichannel Regions

Selections across multiple tracks or on multichannel tracks can be shuffled. Unlike shuffling regions on a single, mono track, any partially selected regions will be cut and moved along with the dragged region. This lets you retain only the material that corresponds to the dragged region, similar to a tape splice and multitrack.

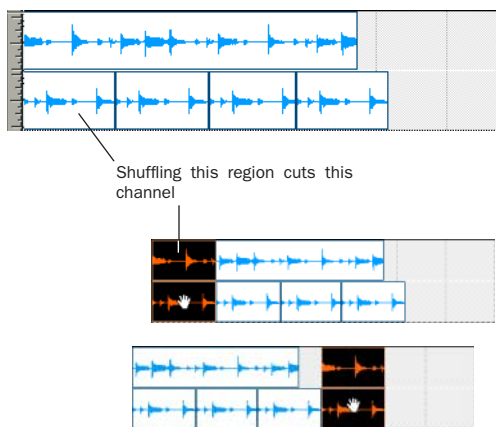

*Shuffling multichannel regions*

## Slipping Regions

In Slip mode, regions can be moved with the Grabber freely within a track, or onto other tracks. In this mode, it is possible to place a region so that there is space between it and other regions in a track. When the track is played back, this space is silent. It is also possible to move a region so that it overlaps or completely covers another region.



### To slip regions:

- 1 Set the Edit mode to Slip by clicking its button in the upper left of the Edit window.
- 2 Drag a region from the Regions List to an empty track.
- 3 Drag a second region from the Regions List to the same track, somewhere in the middle. The second region is placed wherever you release it. It doesn't snap to the first region as in Shuffle mode.
- 4 Drag the regions to different locations within the track to get a feel for moving them in Slip mode. Try placing the second region so that it slightly overlaps the first region. Play back the results.

## Spotting Regions

Spot mode is useful for sessions in which you want to spot regions to precise locations based on any of the Time Scales. This can be particularly useful when performing post production tasks. In Spot mode you can spot a region by specifying a SMPTE frame (all TDM systems and LE systems with DV Toolkit only) or bar and beat location, by capturing an incoming time code address, or by using the region's time stamps.

 *For even quicker spotting, if you are using VITC, use the Auto-Spot Regions command to spot a region to the current SMPTE frame location with the Grabber. For more information, see "Auto-Spotting Regions" on page 569.*

### To spot a region:

- 1 Set the Edit mode to Spot by clicking its button in the upper left of the Edit window.
- 2 Drag a region from the Regions List, or drag audio files or sessions from a DigiBase browser, to an existing track.
  - or –

Click a region already in a track with the Grabber.

- 3 In the Spot dialog, select a time format from the Time Scale pop-up menu.

Each of the fields in the Spot dialog are displayed in the chosen Time Scale.

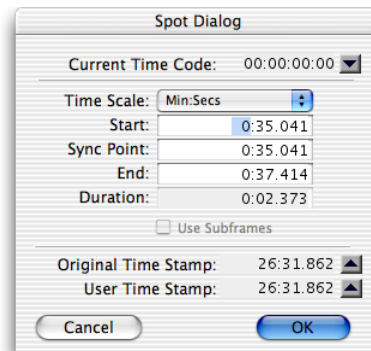

### Spot dialog

- 4 For TDM systems or LE systems with DV Toolkit, if the Time Scale is set to Time Code, select the Use Subframes option to display subframes in the fields for improved accuracy.

5 Click in the field for Start, Sync Point, or End and type in a new location. Changing one of these locate points automatically updates the other locate points.

– or –

Click one of the up arrows next to Original Time Stamp or User Time Stamp to enter the associated values into the currently selected field.

– or –

If you are using an external SMPTE time code source, click the down arrow next to the Current Time Code display—or press Equal (=) on the numeric keypad—to capture an incoming time code address.

6 Click OK. The region is moved to the new location specified for its start, end, or sync point.

If a region does not have a sync point defined, the Sync Point field in the Spot dialog functions the same as the Start field.

To learn more about using SMPTE with Pro Tools, refer to Chapter 35, “Working with Synchronization.”

## Region Time Stamps

When a region is created, it is time stamped relative to the SMPTE start time specified for the session. This Original Time Stamp is permanently stored with the region and cannot be changed. If a region is ever moved, it can easily be placed at its original position from the Spot dialog.

When the Original Time Stamp for a region is initially set, this same location is also used to define the region’s User Time Stamp.

Unlike the Original Time Stamp, the User Time Stamp can be redefined with the Time Stamp Selected command in the Regions List pop-up menu. For more information, see “Time Stamping” on page 570.

## Time Stamps in DigiBase

Columns are provided in DigiBase browsers for both the Original and User Time Stamps.

## Time Stamps and the Takes List

Regions with identical User Time Stamps appear together in the Takes List pop-up menu when auditioning takes. For more information, see “Auditioning from the Takes List Pop-up Menu” on page 166.

## Sliding Regions in Grid Mode

Grid mode provides several useful capabilities for sliding and moving regions in track playlists. This mode is especially useful for lining up regions at precise intervals, as when working with a session that is bar- and beat-based. Grid boundaries, depending on the Main Time Scale, can be based on frames, bar and beat values, minutes or seconds, or a number of samples.

Grid mode also provides two operational modes, Absolute and Relative. These modes control how the Grid is applied. (See “Absolute and Relative Grid Mode” on page 276 for more information.)



*To temporarily suspend Grid mode and switch to Slip mode while dragging a region, hold down the Control key (Windows) or Command key (Macintosh).*

## Setting Up the Grid

When the Display Preference for “Draw Grid in Edit Window” is enabled, vertical Grid lines appear in the Edit window.

Grid lines in the Edit window can also be enabled and disabled by clicking the Timebase Ruler name (Pro Tools 6.x) or its Indicator Dot (Pro Tools 5.x) so it becomes highlighted.

## Defining the Grid Value

In addition to affecting the placement of regions, the Grid value also constrains Edit and Timeline selections, and determines how the Quantize Regions command works.

### To set the Grid value:

**1** From the Display menu, select the Time Scale you will use for the Grid value.

– or –

To keep the Main Time Scale and use a different time format for the Grid, deselect Follow Main Timebase in the Grid Value pop-up menu in the Edit window.

**2** From the Grid Value pop-up menu in the Edit window, select the time value that will define the Grid boundaries.

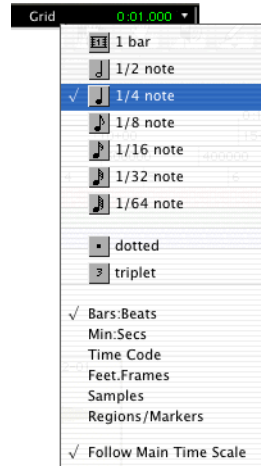

*Grid Value pop-up menu showing Bars:Beats*

– or –

To define a Grid based on the session’s Markers, selections, and region boundaries, select Regions/Markers from the Grid Value pop-up menu.

## Absolute and Relative Grid Mode

Grid mode can be applied in Absolute or Relative mode.

- ◆ In Absolute Grid mode, moving any region snaps the region start to Grid boundaries. If a region's start point falls between beats, and the Grid is set to 1/4 notes, dragging the region will *snap* its start time to the nearest 1/4 note (the current absolute Grid value).
- ◆ In Relative Grid mode, regions can be moved by Grid (or Nudge) *units*. If a region's start point falls between beats and the Grid is set to 1/4 notes, dragging the region will be constrained to 1/4 notes, preserving the region's relative position to the nearest beat.

### To select Absolute or Relative Grid mode:

- Click the Grid mode selector and choose Absolute or Relative.

 *To temporarily suspend Grid mode and switch to Slip mode while dragging a region, hold down the Control key (Windows) or Command key (Macintosh).*

### To place or move a region while in Grid mode:

- 1 Configure the Grid value. For details, see “Defining the Grid Value” on page 275.
- 2 Drag a region from the Regions List to an existing track.

– or –

With the Grabber, drag a region already in a track to a new location.

The region's start point snaps to the closest Grid boundary. If the region has a sync point defined, the sync point snaps to the Grid boundary.

---

## Nudging

Pro Tools can nudge regions (or MIDI notes) by precise increments with the Plus (–) and Minus (+) keys on the numeric keypad. The amount of the nudge is determined by the value specified in the Nudge pop-up menu. The Nudge function can be used in any of the Edit modes.

Nudging can be invaluable for adjusting the “groove” of a musical phrase or a sound effect relative to other elements in the session. Since Pro Tools can nudge material during playback, you can nudge continuously in real time to adjust the timing relationship between tracks.

Nudge can also be used to adjust the placement of automation breakpoints. For more information, see “Editing Automation” on page 467.

### Defining the Nudge Value

The Nudge value determines how far regions and selections are moved when nudging.

Start and end points for selections can also be moved by the Nudge value (see “Nudging Selection Start/End Points” on page 250). In addition, regions can be trimmed by the Nudge value (see “Trimming with Nudge” on page 271).

### To set the Nudge value:

- 1 From the Display menu, select the Time Scale you will use for the Nudge value.

– or –

To keep the Main Time Scale and use a different time format for the Nudge value, deselect Follow Main Timebase in the Nudge pop-up menu in the Edit window.

2 From the Nudge pop-up menu in the Edit window, select the Nudge value.

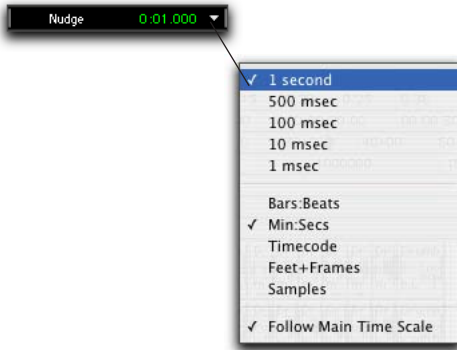

*Nudge pop-up menu showing Time Code*

To specify a Nudge value not listed in the Nudge pop-up, click in the Nudge field and type in the value.

## Nudging Regions

### To nudge one or more region:

- 1 Configure the Nudge value. For details, see “Defining the Nudge Value” on page 276.
- 2 With the Grabber or Selector, select the region or regions you want to nudge. The regions can reside on multiple tracks. Only regions that are entirely selected will be nudged.
- 3 On the numeric keypad, press Plus (+) to move the selection forward by the Nudge value.

– or –

Press Minus (–) to move the selection back by the Nudge value.

The Nudge command works the same regardless of the Edit mode. Adjacent regions are overlapped in Shuffle mode, the Spot dialog does not appear when in Spot mode, and shifted material does not snap to the Grid when in Grid mode.

## Nudging Regions on Multiple Tracks and in Multichannel Tracks

When nudging a selection of multiple regions, within a single track or across multiple tracks, that also contains silence, any automation data residing within the silence is also nudged.

### Nudging by Next Nudge Value

In addition to nudging by the current Nudge value, you can also nudge by the next, larger value in the Nudge pop-up menu.

For example, if the Nudge value is set to 1 frame and you want to nudge by a larger value, you can nudge by the next, larger Nudge value of 10 frames.

### To nudge forward or back by the next, larger Nudge value:

- 1 Enable the Key Commands Focus by clicking the a-z button in the upper left of the Edit window.
- 2 With the Selector or Grabber, select the regions or notes you want to nudge.
- 3 Press slash (/) to nudge the selected material forward by the next Nudge value. Press M to nudge the selection back.

 You can also nudge by the next Nudge value without enabling the Commands Focus. While pressing the Start key (Windows) or Control (Macintosh), press slash (/) or M.

## Nudging a Region's Contents

Often a region's start point will reside at the correct location, perhaps at a SMPTE frame or bar, but the material within the region starts too late or early. You can, in effect, nudge a region's audio waveform or MIDI notes without displacing the region's start and end points.

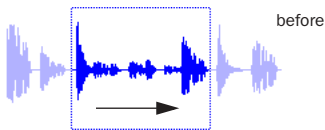

region contents are slid, moving waveform material into and out of the current region boundaries

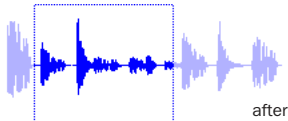

### Nudging region content

This “sliding” of region contents is only possible if there is material residing outside the region's start and end points—from the region having been trimmed, or perhaps captured from a larger region.

#### To nudge the contents of a region without changing the region start and end points:

- 1 Configure the Nudge value. For details, see “Defining the Nudge Value” on page 276.
- 2 With the Grabber, select the region whose contents you want to nudge.
- 3 While pressing the Start key (Windows) or Control (Macintosh), press Plus (+) or Minus (–) on the numeric keypad to move the material by the Nudge value.

## Shift Command

Use the Shift command to move track material forward or back in time by a specified amount. The Shift command can operate on selections, regions, MIDI notes, MIDI controller data, and automation breakpoints.

#### To shift a selection or region:

- 1 Using either the Selector or Grabber, select the track material you want to shift. The selected material can reside on multiple tracks.
- 2 Choose Edit > Shift. In the Shift dialog, select whether the data will be moved Earlier or Later.
- 3 Click in one of the Timebase fields to specify the amount the material will be shifted. Entering a value in one Timebase field automatically updates the others.

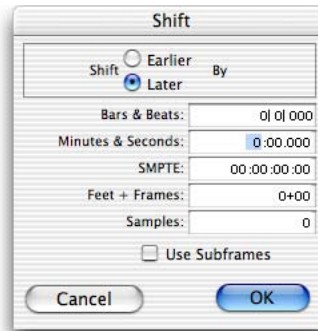

#### Shift dialog

- 4 If you want to shift material with greater precision, select the Use Subframes option.
- 5 Click OK. The material is shifted back or forward by the specified amount.

If a portion of a region was selected, new regions are created from the selection and from any material outside of the selection.

The Shift command works the same regardless of the Edit mode. Adjacent regions are overlapped in Shuffle mode, the Spot dialog does not appear when in Spot mode, and shifted material does not snap to the Grid when in Grid mode.

---

## Quantizing Regions

The Quantize Regions command adjusts the placement of selected audio and MIDI regions so that their start points (or sync points, if they contain one) precisely align to the nearest Grid boundary, which can be based on frames, bar and beat values, minutes or seconds, or a number of samples.

### To quantize one or more regions:

- 1 Configure the Grid value. For details, see “Defining the Grid Value” on page 275.
- 2 With the Grabber or Selector, select the region or regions you want to quantize. The regions can be on multiple tracks. Only regions that are entirely selected will be quantized.
- 3 Choose Edit > Quantize Regions. Region start times (or sync points) are aligned to the boundaries for the defined Grid.

For MIDI regions, all data contained within the regions (such as notes) are moved equally, thereby retaining their rhythmic relationships. To quantize individual MIDI notes, use the Quantize command in the MIDI menu (see “Quantize” on page 380).

---

## Locking Regions

If you have a region or group of regions that you want to permanently associate with a particular location in a track (a beat, SMPTE frame, or sample location), you can lock it in place so it will not be accidentally moved.

### To lock a region:

- 1 With the Grabber, select the region or regions to lock. The regions can even reside on multiple tracks.
- 2 Choose Edit > Lock/Unlock Region.



### Locked audio region

A small lock appears in the region, indicating it has been locked and cannot be moved. If you attempt to perform edits that would move a locked region, Pro Tools alerts you.

In Shuffle mode, locked regions, and all regions occurring after the locked region, are not displaced when other neighboring regions are moved. If there is not enough room to place or duplicate a region in front of a locked region, the insertion area is disabled.

**⚠** *Locking a region prevents it from being moved or deleted only—operations such as recording and automation editing still affect it.*

---

## Muting/Unmuting Regions

Choosing the Mute/Unmute Region command mutes playback of a selected region. Choosing the command a second time unmutes the region. Regions that are muted become dimmed to indicate their status.

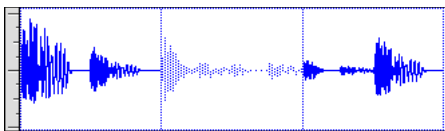

*Muted audio region (middle)*

### To mute a region or regions:

- 1 With the Grabber, select the region or regions you want to mute. The regions can even reside on multiple tracks.
- 2 Choose Edit > Mute/Unmute Region. The selected regions become dimmed, indicating they are muted.

To unmute a region, select it and choose Edit > Mute/Unmute Region.

---

## Edit Commands

### Cut, Copy, Clear, and Paste

Use the Cut, Copy, Clear, and Paste commands to rearrange and edit track material. Edits can operate on entire regions selected with the Grabber, or on track ranges selected with the Selector. Edits can also work across multiple tracks (see “Editing Across Multiple Tracks” on page 283).

 For TDM systems, you can cut, copy, and paste discontinuous regions selected with the Object Grabber.

## Track View and Edit Content

When cutting or copying track material, the Track View determines the type of data placed on the Clipboard. When displaying waveforms for audio tracks, or notes or regions for MIDI tracks, selections include all underlying automation and controller data. Thus, cutting an audio region also cuts any volume, pan, mute, send, or plug-in automation that is also on the track. This saves you from having to individually cut from each automation playlist on the track.

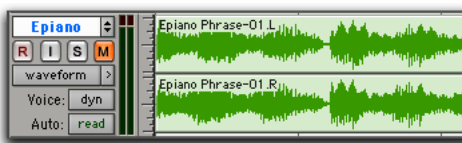

*Audio waveform data*

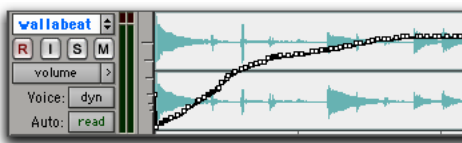

*Automation data (breakpoint-type data)*

However, when selecting groups of MIDI notes with the Grabber (by drawing a rectangle around them), only the note data is placed on the Clipboard. When selecting a time range of MIDI notes with the Selector, all controller data in the track is selected (similar to selecting with the Selector for audio tracks in Waveform view).

When a track is displaying automation data or controller data, only that data is placed on the Clipboard. Also, whenever you cut or copy automation data, bounding breakpoints are created at each end of the selected area, in order to preserve the slope of the automation both inside and outside the selection.



If tracks are grouped, copying and pasting on any of the tracks affects each of the other tracks in the group. Tracks that are hidden—even if they are part of a group being edited—are not affected by edits.

The current Edit mode affects how material is selected, copied, and pasted:

- In Slip mode, the Cut command leaves an empty space corresponding to the data removed from the track.
- In Shuffle mode, the Cut command leaves no empty space, since the regions to the right of the cut slide over, closing the gap.
- In Slip mode, pasted data can overlap an adjacent region.
- In Shuffle mode, pasted data causes all regions to slide over to make room for the pasted material.

New regions are often auto-created when performing edits. For instance, when clearing a selection from a region, new regions are auto-created from the material residing outside of the selection.

### Copying and Pasting Automation

The following are two special functions for copying and pasting automation data.

- ◆ To copy all automation playlists for a track, press the Start key (Windows) or Control (Macintosh) when copying from any of the track's automation playlists. This special function also works across multiple tracks.
- ◆ To paste from one type of automation playlist to another similar playlist (for instance, from a volume playlist to a send level playlist), press the Start key (Windows) or Control (Macintosh) when pasting.

For more information on working with automation data, see Chapter 28, “Automation.”

### Clear Command

Use the Clear command to remove a selection from a track without placing it on the Clipboard.

#### To clear a selection or region:

- 1 If you want to constrain the selection to the current grid value, set the Edit mode to Grid.
- 2 Set the Display Format for the tracks you want to edit.

When displaying waveforms for audio tracks, or notes or regions for MIDI tracks, selections include underlying automation and controller data. If the track is displaying automation data, only the automation data is affected by the edits.

- 3 Drag with the Selector in the track to select the material you want to clear.

– or –

Use the Grabber to select one or more regions (or a group of MIDI notes).

- 4 Choose Edit > Clear to remove the selection.

If a portion of a region was cleared, new regions are auto-created from the material residing outside of the selection. If working in Shuffle mode, adjacent regions are slid over, as necessary, to fill the blank space.

### Cut and Copy Commands

Use the Cut command to place the selection on the Clipboard while also removing it from the track.

Use the Copy command to place a selection on the Clipboard so it can be pasted to another track, or to the same track at a different location.

### **To cut or copy a selection or region:**

- 1** If you want to constrain the selection to the current grid value, set the Edit mode to Grid.
- 2** Set the Display Format for the tracks you want to edit.

When displaying waveforms for audio tracks, or notes or regions for MIDI tracks, selections include underlying automation and controller data. If the track is displaying automation data, only the automation data is affected by the edits.

- 3** Drag with the Selector in the track to select the material you want to cut or copy.

– or –

Use the Grabber to select one or more regions (or a group of MIDI notes).

- 4** Choose Edit > Cut to remove the selection and place it on the Clipboard.

– or –

Choose Edit > Copy to place the selection on the Clipboard, without removing it.

If a portion of a region was cut or copied, the material on the Clipboard appears as a new region in the Regions List. If a portion of a region was cut, new regions are auto-created from the material residing outside of the selection.

When working in Shuffle mode, adjacent regions are slid over, as necessary, to fill blank spaces.

### **Deleting Underlying Region Data**

When removing a region or selection, you can choose to remove or keep the underlying region data.

#### **To delete a region or selection along with the underlying region data:**

- Choose Edit > Cut.

#### **To delete a region or selection without removing the underlying region data:**

- Choose Edit > Clear.

### **Paste Command**

Use the Paste command to place the Clipboard's contents at the Edit insertion point, overwriting existing material already there.

#### **To paste a selection or region:**

- 1** If you want to constrain the insertion point or the selection to the current grid value, set the Edit mode to Grid.

- 2** With the Selector, click in a track at the point where you want to paste the material. Press Tab to move the insertion point forward to region start and end times; to move back, press Control+Tab (Windows) or Option+Tab (Macintosh).

– or –

Use the Selector or Grabber to make a selection where the material will be placed.

- 3** Choose Copy > Paste.

If pasting at an insertion point in Shuffle mode, material to the right of the paste point is shifted to the right. In Slip mode, the material is overwritten with the paste.

If pasting into a selection in Shuffle mode, the selection is replaced by the Clipboard's contents with the adjacent material slid left or right as necessary. In Slip mode, the selection is also replaced but with the surrounding material remaining unchanged.

 *When working with MIDI, you can merge the contents of the Clipboard with material in the destination track. For details, see “Merge Paste Command” on page 285.*

 *For TDM systems, the Fill Paste command can be used to fill a selection with the contents of the Clipboard. For details, see “Repeat Paste To Fill Selection” on page 293.*

## Editing Across Multiple Tracks

When working with data from multiple tracks, there are some important points to remember. For instance, if any of the selected tracks are set to their master view (see “The Master View Format” on page 210), edits affect not only audio and MIDI for the selected tracks, but *all* automation and controller data as well.

If all selected tracks are displayed as automation data, edits only affect the type of automation data displayed in each track. Furthermore, if track 1 displays Pan automation, track 2 displays Volume automation, and track 3 displays Mute automation, the Cut command cuts *only* pan data from track 1, volume data from track 2, and mute data from track 3.

 *For details on selecting data on multiple tracks, see “Selecting Across Multiple Tracks” on page 252.*

When copying only automation or controller data for selected tracks, press the Start key (Windows) or Control (Macintosh) to copy all types of automation on *all* selected tracks.

To paste to multiple tracks, place the insertion point in each of the destination tracks by Shift-clicking in them—or to select all tracks, Alt-Shift-click (Windows) or Option-Shift-click (Macintosh) in a track, or make a selection in one of the Timebase Rulers.

When you paste multiple types of data, whatever data has been copied is pasted into the correct type of playlist. Automation data is pasted into the corresponding automation playlist. Audio/MIDI data is pasted into the audio/MIDI playlist. You don't need to set target tracks to the specific type of data being pasted for the paste to work correctly.

If *all* destination tracks in a multitrack paste are displayed as automation, the paste replaces any previous data on the target track without shuffling—regardless of whether you are in Slip or Shuffle mode.

---

## Duplicate Command

The Duplicate command copies a selection and places it immediately after the end of the selection. Though this is similar to using Copy and Paste, Duplicate is more convenient and faster, particularly when working with data on multiple tracks.

To make more than one copy of a selection, use the Repeat command (see “Repeat Command” on page 284).

As with the Copy and Paste commands, certain rules apply when duplicating material on multiple tracks. For details, see “Editing Across Multiple Tracks” on page 283.

 *The Duplicate command does not operate on conductor events.*

### To duplicate a selection or region:

- 1 If working with material that is bar- and beat-based, such as loops, set the Main Time Scale to Bars:Beats.
- 2 If you want to constrain the selection to the current grid value, set the Edit mode to Grid.
- 3 Drag with the Selector in the track to select the material you want to duplicate.

– or –

Click in the track and enter the start and end points for the selection in the Event Edit area.

- 4 Choose Edit > Duplicate. The material is placed immediately after the selection's end point.

In Shuffle mode, the duplicated data is placed directly after the end of the selection. Regions occurring after it are slid to accommodate the duplicated material. In Slip mode, the duplicated material overlaps any adjacent data.

When using Duplicate or Repeat with MIDI notes that were selected with the Grabber, material is always duplicated one measure later, and is merged with existing track material (instead of replacing).

### Duplicating Audio

When using Duplicate or Repeat for audio that must fall cleanly on the beat (for loops), it is important that you select the audio material with the Selector, or by typing in the start and end points in the Event Edit area. If you select an audio region with the Grabber (or by double-clicking it with the Selector), the material may drift by several ticks because of sample-rounding.

If, on the other hand, you want to Duplicate or Repeat audio that is not bar- and beat-based, set the Time Scale to any format except Bars:Beats. This ensures that the duplicated audio material will have the correct number of samples and will be placed accordingly.

---

## Repeat Command

The Repeat command is similar to Duplicate, but allows you to specify the number of times the selected material is duplicated.

As with the Copy and Paste commands, certain rules apply when repeating material on multiple tracks. For details, see “Editing Across Multiple Tracks” on page 283.

To repeatedly paste copied data until it completely fills a selection (TDM systems only), see “Repeat Paste To Fill Selection” on page 293.

 *The Repeat command does not operate on conductor events.*

### To repeat a selection or region:

- 1 If working with material that is bar- and beat-based, such as loops, set the Main Time Scale to Bars:Beats.
- 2 If you want to constrain the selection to the current grid value, set the Edit mode to Grid.
- 3 Drag with the Selector in the track to select the material you want to repeat.

– or –

Click in the track and enter the start and end points for the selection in the Event Edit area.

4 Choose Edit > Repeat. In the Repeat dialog, enter the number of times you want the material to repeat, then click OK.



#### *Repeat dialog*

The material is placed immediately after the selection's end point, and duplicated by the number of times specified.

In Shuffle mode, the repeated data is placed directly after the end of the selection. Regions occurring after it are slid to accommodate the repeated material. In Slip mode, the repeated material overlaps any adjacent data.

---

## Merge Paste Command

Use the Merge Paste command to merge MIDI notes from the Clipboard with material already residing in the paste destination. To replace track material, use the Paste command instead.

#### **To merge MIDI data:**

1 If you want to constrain the selection to the current grid value, set the Edit mode to Grid.

2 Drag with the Selector in the track to select the MIDI notes you want to merge.

– or –

Use the Grabber to select one or more MIDI regions (or a group of MIDI notes).

3 Choose Edit > Cut to remove the selection and place it on the Clipboard.

– or –

Choose Edit > Copy to place the selection on the Clipboard without removing it.

4 With the Selector, click in a MIDI track at the point where you want to merge the material.

5 Choose Edit > Merge Paste. The Clipboard's contents are pasted at the insertion point, without removing the existing material already residing there.

If any portion of the material is pasted outside of existing regions, a new region is created for the data.

---

## Editing Stereo and Multichannel Tracks

Regions on individual channels within stereo and multichannel tracks cannot be independently selected. All selections for these tracks are time-based, which means that selections made with the Selector and Grabber extend to each channel in the track.

When regions in multichannel tracks are edited with the Trimmer or dragged with the Grabber, material on all channels is affected equally as a group.

#### **Split Selected Tracks**

To edit a specific channel within a stereo or multichannel track without affecting the other channels, you can split the track into separate mono tracks. Once the edits have been made to the separated material, you can then drag or copy it back to the original multichannel track.

### To split a stereo or multichannel track:

1 Select the track you want to split by clicking its name in the Edit or Mix window. To split multiple tracks, Shift-click additional tracks.

2 Choose File > Split Selected Tracks Into Mono. Regions from the channels on the selected tracks are placed on new, mono audio tracks.

Names for the new tracks are based on the source track name and channel suffix. For example, if a stereo track called “Funkit” is split, two new tracks called “Funkit.L” and “Funkit.R” are created.

Output and send assignments and volume and pan settings are retained in the new tracks. Mono equivalents of stereo and multi-mono plug-in assignments are assigned in the new tracks; multichannel plug-in assignments are not assigned in the new tracks.

### Dragging Regions to and from Stereo and Multichannel Tracks

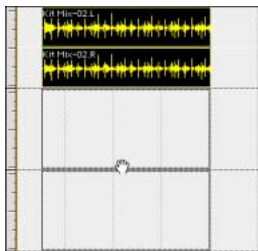

#### *Dragging a stereo region to two mono audio tracks*

When dragging regions to or from stereo or multichannel tracks, the following rules apply:

- ◆ Provided the number of tracks and channels are the same for the source and destination, you can drag regions between multichannel tracks and mono tracks.

- ◆ The source and destination for dragged regions can be mixed. For example, you can drag regions from a 5.0 track (containing five channels) to a stereo track and three mono audio tracks.

- ◆ When dragging multichannel regions to mono tracks, the destination tracks must be adjacent.

- ◆ When dragging regions from mono tracks to a multichannel track, the source tracks need not be adjacent.

Multichannel regions can also be dragged from the Audio Regions List, to multichannel tracks of the same format, groups of mono audio tracks, or a combination of both.

Conversely, a collection of single, mono regions can be dragged from the Audio Regions List to multichannel tracks—provided the dragged number of regions matches the number of channels in the destination track.

---

## Processing Audio with AudioSuite Plug-Ins

The AudioSuite plug-ins included with your Pro Tools system can be used to process and modify an audio region or entire audio file. You may do this in order to apply a specific AudioSuite process, such as Normalization or DC Offset Removal, that you know you will always want applied to the audio.

 Refer to the *DigiRack Plug-Ins Guide* for more information about AudioSuite plug-ins.

---

## Waveform Repair with the Pencil Tool

The Pencil tool allows you to destructively “re-draw” waveform data. This tool is most commonly used to repair a pop or click in an audio file. A pop or click appears as a sudden sharp spike in a waveform. This tool only becomes active when the Edit window is zoomed in to the sample level.

**⚠** *The Pencil tool is a destructive editing tool that permanently modifies the audio file on disk and should be used with caution.*

Although you can Undo a Pencil tool edit, it is recommended that you create a backup copy of the target audio, before using the Pencil tool. You can do this by using the AudioSuite Duplicate plug-in.

### To make a copy of an audio region:

- 1 Select the source region in the track’s playlist.
- 2 Choose AudioSuite > Duplicate.
- 3 In the AudioSuite dialog, make sure that Playlist is enabled as the processing preference, and that Use In Playlist is enabled.
- 4 Click the Process button.

The AudioSuite Duplicate plug-in creates a new audio file that is a duplicate of the original. The duplicate replaces the original on the track, and it is automatically named with the region name and the suffix DUPL.

### To destructively edit an audio waveform with the Pencil tool:

- 1 Locate the area you want to edit.
- 2 Using the Zoomer tool or the Vertical Zoom buttons, zoom down to the sample level so the waveform appears as a continuous thin line. Adjust the Track Height, as necessary, to edit the waveform with greater precision

 *You can recall zoom levels with the Zoom Preset buttons (see “Zooming” on page 226), or with Memory Locations (see “Memory Locations and Markers” on page 324).*

- 3 Select the Pencil tool.



**Pencil tool**

- 4 Carefully draw with the Pencil by dragging over the area of the waveform.

Don’t over-edit or the results may be undesirable. You can use the Undo command to undo your previous edit.

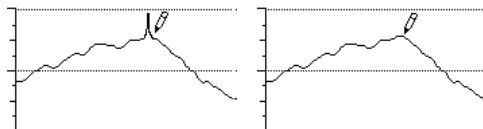

**Repairing a “pop” with the Pencil tool**

Try to limit editing to smoothing over a very small problem area, and keep the “fixes” in character with the shape of the surrounding waveform.

 *If you have trouble zooming in far enough to perform Pencil editing, check the Edit window (session) length. Shorten the overall Edit window (session) length, if possible, until the Pencil tool becomes usable.*

---

## The Smart Tool

With the Smart Tool you can instantly access the Selector, Grabber, and Trimmer, and you can also perform fades and crossfades. The position of the cursor in relation to a region or note, or within an automation playlist, determines how the Smart Tool functions.



Smart Tool in Edit window

To select the Smart Tool, click its icon in the upper left of the Edit window, or press F6+F7 (or F7+F8) simultaneously.

 To temporarily switch the Smart Tool to the Scrubber, place the cursor over the region so that the Selector is enabled, then press the Start key (Windows) or Control (Macintosh), or right-click the mouse.

### The Smart Tool in Waveform View (or MIDI Track Regions View)

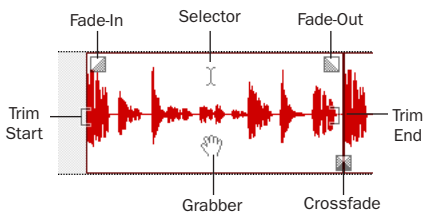

Smart Tool in Waveform View

The following capabilities are available with the Smart Tool when working with audio tracks in Waveform or Blocks View, or MIDI tracks in Regions View:

- ◆ For the Selector, position the cursor over the middle of the region, in the upper half.

- ◆ For the Grabber, position the cursor over the middle of a region, in the lower half.

- ◆ For the Trimmer, position the cursor near the region's start or end point.

- ◆ For a fade-in or fade-out, position the cursor near an audio region's start or end point, near the top. Once the Fade cursor appears, drag into the region to set the fade length. The fade is created automatically with the Default Fade Settings (in the Editing Preferences).

- ◆ For a crossfade, position the cursor between two adjacent audio regions, near the bottom. Once the Crossfade cursor appears drag left or right to set the crossfade length. The crossfade is created automatically with the Default Fade Settings (in the Editing Preferences).

### The Smart Tool in Notes View

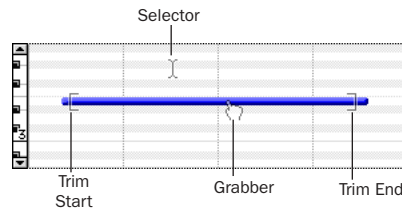

Smart Tool in Notes View

The following capabilities are available with the Smart Tool when working with MIDI tracks in Notes View:

- ◆ For the Selector, position the cursor so it doesn't cover any notes.

To get the Selector while positioning the cursor over notes, press Control (Windows) or Command (Macintosh).

- ◆ For the Grabber, position the cursor over the note, near its middle.



To get the Marquee so you can select a group of notes, position the cursor so it doesn't cover any notes and press Control (Windows) or Command (Macintosh).

◆ For the Trimmer, position the cursor near the note's start or end point.

 *To temporarily switch the Smart Tool to the Eraser, place the cursor over the region so that the Selector is enabled, then press Start+Alt (Windows) or Control+Option (Macintosh).*

## The Smart Tool in Automation and Controller Views

The following capabilities are available with the Smart Tool when working in both automation and controller views:

### Selector

Position the cursor anywhere in the bottom 75% of the playlist for the Selector. Drag with the Selector to select breakpoints.

### Trimmer

Position the cursor in the top 25% of the playlist for the Trimmer. Drag with the Trimmer to trim breakpoints. Press Control (Windows) or Command (Macintosh) *after* you begin trimming for fine control.

### Grabber

To create breakpoints with the Grabber, press Control (Windows) or Command (Macintosh) and the Grabber will appear.

To edit existing breakpoints, move the cursor near a breakpoint and the Grabber will appear.

For fine control with the Grabber, Control (Windows) or press Command (Macintosh)—or continue to hold the key if you are creating a new breakpoint.

To vertically constrain Grabber movement, press Shift.

To vertically constrain Grabber movement with fine control, press Control+Shift (Windows) or Command+Shift (Macintosh).

## The Smart Tool with Stereo and Multichannel Tracks

When using the Smart Tool on stereo and multichannel tracks, individual channels cannot be independently edited. All edits affects all channels as a whole.

The tool switching for the Smart Tool in stereo and multichannel tracks is determined by the position within the entire track, and not within individual channels.



# Chapter 18: Advanced Editing (TDM Systems Only)

## Replacing Audio Regions

(TDM Systems Only)

You can use the Replace Region function to replace multiple instances of an audio region in a playlist with another region that you Control-drag (Windows) or Command-drag (Macintosh) from the Regions List.



Replace Region dialog

This is useful in post production if you use a sound effect, room noise, or atmosphere region many times in a session, and later decide to replace one or all of the original regions with a different region.

This is also useful in music production if you want to replace a certain loop or sample (for example, a drum beat) with a new one. You can use this compositionally, if you know the tempo of a section or session, to create a scratch piece with “rough” regions of the correct length, and later replace them with “final” regions of the same length.

The following options are available in the Replace Region dialog:

**Replace Original Region** Replaces only the selected region with the replacement region dragged from the Regions List.

**Replace All Regions That Match Original** Replaces all regions that fit the Match criteria and the Find Match On criteria with the replacement region from the Regions List.

**Match: Start Position** Replaces all regions that have the same original *start* time as the selected region. This includes regions that may have been auto-created when trimming end points.

**Match: End Position** Replaces all regions that have the same original *end* time as the selected region. This includes regions that may have been auto-created when trimming start points.

**Match: Region Name** Replaces all regions that have the same name as the selected region.

Region matching uses all specified Match criteria. For example, if you select Start Position and End Position, all regions from the same original audio file as your selection with the same original start and end times will be replaced.

**Find Match On: This Track Only** Replaces regions that fit the Match criteria and are on the same track as the original region.

**Find Match On: All Tracks** Replaces regions that fit the Match criteria for all tracks in the session.

**Fit To: Original Region Length** If the replacement region is smaller than the original region, the region is placed in the playlist and any remaining audio from the original region is removed.

If the replacement region is larger than the selection, it is placed in the playlist and trimmed to fit within the length of the original region.

**Fit To: Original Selection Length** When the playlist selection extends beyond the original region, the replacement region (if larger than the original region) is trimmed to fit within the selection.

**Fit To: Replacement Region Length** The replacement region is placed in its entirety, regardless of the length of the original region or selection.

The Replace Region function only works on a selection that includes a single region on one track. The function is not available when the playlist selection includes the start points for two or more regions. Also, if the selection is across several tracks, only the selection in the first (top) track is used.

#### To replace regions:

- 1 Select a region in a track's playlist that you want to replace. The selection can extend beyond the region's end point, to include material from the replacement region that is longer than the original region.

- 2 Control-drag (Windows) or Command-drag (Macintosh) the replacement region from the Regions List to the selected region. The Replace Region dialog opens.

- 3 If you want to replace only the original region, select Replace Original Region.

– or –

If you want to replace multiple regions, select Replace All Regions That Match Original, and set the Match criteria.

- 4 Select whether to apply the replacement to all tracks, or only to the track with the current selection.

- 5 Select whether to fit the replacement regions to the current selection, the entire region, or the entire replacement region regardless of the destination length.

- 6 When you have set all the options, click OK.

## Replace Region and Multichannel Tracks

The Replace Region command supports dragging multichannel regions from the Audio Regions List to multichannel tracks, provided they are the same format.

For example, you can replace a stereo region, selected in a stereo audio track, with another stereo region from the Audio Regions List. But you cannot replace it with two mono audio regions.

In addition, replacing regions in multiple mono tracks with multichannel regions is not supported.

---

## Repeat Paste To Fill Selection (TDM Systems Only)

The Repeat Paste To Fill Selection command allows you to automatically fill a selection with audio or MIDI data without requiring you to duplicate the regions manually. To use Repeat Paste, copy an audio or MIDI region, then make a selection and use the command to fill the selection. When pasting audio regions, you are prompted to specify a crossfade to be used for the pasted regions.

If you fill an area that is an exact multiple of the copied region size (for example, filling 16 bars with a 4-bar loop), the copied selection is pasted in exactly as many times as it takes to fill the selection. If you fill an area that is not an exact multiple of the copied region size (for example, filling 15 seconds of a track with a 2-second atmosphere or room noise region), the remaining selection area is filled with an automatically trimmed version of the original selection.

### To fill a selection with Paste to Fill:

- 1 Select the audio or MIDI region you want to copy and choose Edit > Copy.
- 2 Select the area you want to fill using the Selector and choose Edit > Repeat Paste To Fill Selection.
- 3 If pasting audio regions to larger areas, the Batch Fades dialog opens. Configure the dialog to insert crossfades between each pasted region, then click OK.

– or –

If you do not want crossfades for the pasted audio, click Cancel in the Batch Fades dialog.

---

## Compress/Expand Edit To Play

### (TDM Systems Only)

When the Edit and Timeline selections are unlinked, you can compress or expand an audio selection to fit the Timeline selection. This feature works by using the Time Compression/Expansion plug-in to expand or compress the selected audio material.

### To fit an Edit selection to the Timeline:

- 1 Deselect Operations > Link Edit and Timeline Selection.
- 2 With the Selector, select the audio material to be compressed or expanded.
- 3 In any Timebase Ruler, select the time range where you want to fit the audio material.
- 4 Choose Edit > Compress/Expand Edit To Play. The Edit selection is compressed or expanded to the length of the Timeline selection.

## **Compress/Expand Edit to Play on Multiple Tracks and Channels**

The Compress/Expand Edit to Play command can be used on multichannel selections, and selections across multiple tracks.

However, all regions are compressed or expanded equally by the same percentage value, based on Edit selection range. This ensures that the rhythmic relationship between the different channels or tracks is retained.

## **Fitting an Audio Region to an Edit Selection**

Regions can be dragged from the Audio Regions List to fit within an Edit selection. The dragged region is compressed or expanded to fit within the selection. This feature uses the Time Compression/Expansion plug-in to expand or compress the audio region.

### **To fit an audio region to an Edit selection:**

**1** With the Selector, select a time range in an audio track.

**2** Control-Alt-drag (Windows) or Command-Option-drag (Macintosh) the region from the Audio Regions List to the track with the selection. The start of the region is positioned at the selection start, and the region is compressed or expanded to match the length of the selection.

## **Fit to Selection on Multiple Tracks and Channels**

The Fit to Selection command supports dragging multiple regions from the Audio Regions List to multiple tracks, or multichannel tracks.

However, all dragged regions are compressed or expanded equally by the same percentage value, based on length of the region last clicked before dragging.

# Chapter 19: Fades and Crossfades

---

## Using Crossfades

You can quickly and easily crossfade between two adjacent audio regions. Crossfading is the process of fading two regions of audio to prevent pops, clicks, or sudden changes in sound. Crossfades have many applications, from smoothing transitions between regions to creating special audio effects. The crossfade duration, position, and shape are all user-definable.

Crossfades are computed and written to disk. Crossfades that are written to disk are stored in a folder named “Fade Files” within the session folder. When you play back your track, Pro Tools reads and plays back the crossfade file from disk.

Pro Tools does not allow you to replace fade-ins and fade-outs with crossfades. To add a crossfade between regions, any existing fade-ins and fade-outs between the regions must first be deleted.

 *Pro Tools TDM systems include an Auto Fade feature that provides real-time fades without processing them to disk. See “Using AutoFades” on page 305.*

## About Crossfades and Curves

To create a crossfade between two regions, use the Selector to select across the end point of the first region and the start point of the second. The length of the selection determines the length of the crossfade. Though fades may appear to be discrete regions, they cannot actually be separated from the regions in which they were created. You can, however, create fade-ins and fade-outs for individual regions (see “Creating Fades at the Beginnings and Ends of Regions” on page 303).

You can use the Fades dialog to select, view, and manipulate the curves used to perform the crossfade. Different volume curves can be assigned to the fade-out and fade-in portions of crossfades. The Fades dialog can also render a preview of the fade.

The following examples illustrate common crossfade types, and explain how the type of selection you make determines the character of the crossfade.

 *Since crossfades are created by fading between overlapping audio material, a crossfade cannot be performed on regions that do not contain audio material beyond their region boundaries.*

## Standard Crossfade (Centered)

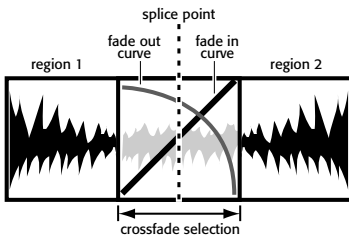

### Centered crossfade

This type of selection creates a crossfade on both sides of the splice point, which affects the volume of region 1 and region 2. It is the most common type of crossfade.

This crossfade type requires that region 1 contain audio material beyond its end point, and region 2 contain audio material before its start point.

## Pre Crossfade

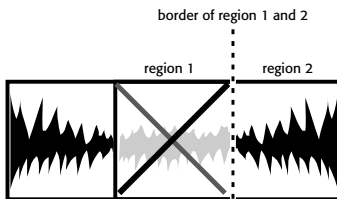

selection range extends just up to beginning of region 2

### Pre crossfade

This type of selection creates a crossfade before the splice point. This lets you maintain the volume of the very beginning of region 2 instead of fading across it, which is useful if there is a strong attack at the beginning of region 2 that you want to preserve. When making selections for crossfades that occur on the border of two regions, you can use the Tab key to move the cursor to the exact beginning or end of a region.

This crossfade type requires that region 2 contain audio material before its start point.

## Post Crossfade

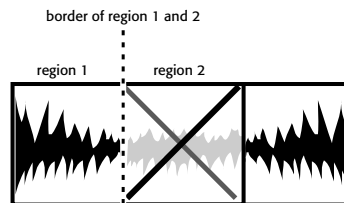

selection range begins just after end of region 1

### Post crossfade

This type of selection creates a crossfade after the splice point. It is useful if you want to maintain the amplitude of region 1 until its very end. When making selections for crossfades that occur on the border of two regions, you can use the Tab key to move the cursor to the exact beginning or end of a region.

This crossfade type requires that region 1 contain audio material beyond its end point.



## The Fades Dialog

When choosing the Edit > Fades command you can use the Fades dialog to select, view, and preview the crossfade, and to edit the curves used to perform the crossfade.

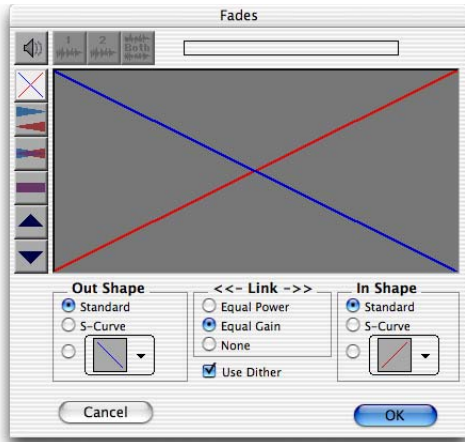

*Fades dialog*

The controls in the Fades dialog include:

### Audition



Click this button to audition your crossfade. Pro Tools plays the audio in one of two ways, depending on your system:

- ◆ Pro Tools TDM and LE systems allow crossfade auditioning directly from your audio interface outputs.

### View First Track



If you are fading between more than one track, this button allows you to view and preview the audio of the first pair of adjacent tracks.

### View Second Track



If you are fading between more than one track this button allows you to view and preview the audio of the second pair of adjacent tracks.

### View Both Tracks



Click this button to display the waveforms of the first two adjacent tracks in a multitrack fade.

### Fade Curves Only



Click this button to display the specified fade curves without showing the actual audio waveforms. This is the default view when you open the Fades dialog.

### Fade Curves and Separate Waveforms



Click this button to display the specified fade curves along with separate views of the fade-in and fade-out waveforms.

### Fade Curves and Superimposed Waveforms



Click this button to display the specified fade curves along with superimposed views of the fade-in and fade-out waveforms.

### Fade Curves and Summed Waveform



Click this button to display the specified fade curves along with a single waveform representing the summation of the crossfaded audio.

## Zoom In



Click this button to scale the view of the waveform's amplitude upwards. Control-click (Windows) or Command-click (Macintosh) for the default view scale.

## Zoom Out



Click this button to scale the view of the waveform's amplitude downwards. Control-click (Windows) or Command-click (Macintosh) for the default view scale.

## Fade Out Shape Setting

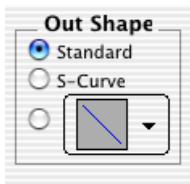

*Fade Out Shape*

The Out Shape setting allows you to choose the shape of the fade-out from region 1.

**Standard** Selects a single continuous fade curve. This creates a general-purpose fade that can be edited by dragging the curve itself.

**S-Curve** Selects an S-shaped curve, which inverts its beginning and end characteristics. This makes it possible to fade out faster at the curve's start and slower at its end, for example. S-shaped curves can be useful with material that is difficult to crossfade effectively. S-curves can be edited by dragging the curve in the curve editor.

**Preset Curves** Seven commonly used preset curves are provided for fast crossfade creation. These can be edited by dragging the end points of the curve in the curve editor portion of this dialog. The seven presets are as follows:

◆ Preset Curve 1 keeps region 1 at full volume throughout the crossfade, then immediately drops the volume at the end of the crossfade.



*Preset Curve 1*

◆ Preset Curve 2 fades out region 1 relatively slowly, keeping the volume fairly high throughout the duration of the fade.



*Preset Curve 2*

◆ Preset Curve 3 fades out region 1 slightly faster, keeping the volume slightly lower during the fade.



*Preset Curve 3*

◆ Preset Curve 4 fades out region 1 with a linear fade. This is the default curve.



*Preset Curve 4*

◆ Preset Curve 5 fades out region 1 quickly at the beginning of the crossfade.



*Preset Curve 5*

- ◆ Preset Curve 6 drops the volume of region 1 even more quickly at the beginning of the crossfade.



Preset Curve 6

- ◆ Preset Curve 7 silences region 1 at the beginning of the crossfade.



Preset Curve 7

## Link Settings

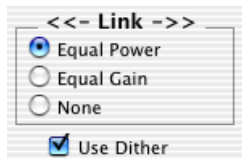

Fade Link

The Link setting links the selected fade-out and fade-in curves. If you adjust one curve, the corresponding curve also adjusts. This ensures that the resulting crossfade is an *equal power* or *equal gain* crossfade, depending on which you select.

**Equal Power** Recommended for material that is not phase coherent, as in the case of a crossfade between two completely different types of material. Use this option to avoid the volume drop that can occur with an Equal Gain crossfade. With this fade, you can Alt-click (Windows) or Option-click (Macintosh) the fade curve to reset it to its default shape.

**Equal Gain** Recommended for material that is phase-coherent or nearly phase-coherent, as in the case of a crossfade between identical regions/instruments (for example, a repeated drum loop). Use this option to avoid clipping

that can occur when using an Equal Power crossfade. With this fade, you can Alt-click (Windows) or Option-click (Macintosh) the fade curve to reset it to its default shape.

**None** Disables linking between the fade-out and fade-in curves, and lets you freely adjust them separately, including start and end points. This option also allows you to create custom crossfade shapes. To edit only the fade-in portion of the curve, press Alt (Windows) or Option (Macintosh) while dragging. To edit only the fade-out portion of the curve, press Control (Windows) or Command (Macintosh) while dragging.

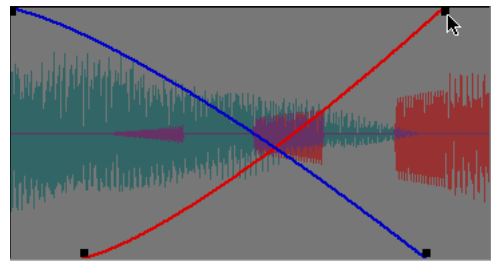

Adjusting the end point of a fade curve

## Use Dither

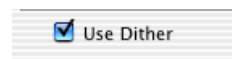

Dither option for Fade

The Use Dither option turns on a preset, noise-shaped dither function that improves audio performance when fading in or fading out of silence, and crossfading between low amplitude regions. Dithering is usually not necessary when fading between two regions of high amplitude. You can disable Dither while editing your crossfades in the Fades dialog to speed up previews and fade recalculation, then re-enable Dither to create the final crossfade.

## Fade In Shape Settings

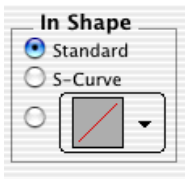

### Fade In Shape

The In Shape setting allows you to choose the shape of the fade-in to region 2.

**Standard** Selects a single continuous fade curve. This creates a general-purpose fade that can be edited by dragging the curve itself.

**S-Curve** Selects an S-shaped curve, which inverts its beginning and end characteristics. This makes it possible to fade in faster at the start of the curve, and slower at the end. S-shaped curves are useful with material that is difficult to crossfade effectively. S-curves can be edited by dragging the curve in the curve editor.

**Preset Curves** Seven commonly used preset curves are provided for fast crossfade creation. These can be edited by dragging the end points of the curve in the curve editor portion of this dialog. The seven presets are as follows:

- ◆ Preset Curve 1 fades in region 2 at full volume immediately at the beginning of the crossfade and keeps it there throughout the crossfade.



Preset Curve 1

- ◆ Preset Curve 2 fades in region 2 quickly in the beginning, reaching full amplitude fairly early in the crossfade.



Preset Curve 2

- ◆ Preset Curve 3 fades in region 2 moderately fast.



Preset Curve 3

- ◆ Preset Curve 4 fades in region 2 with a linear fade curve. This is the default curve.



Preset Curve 4

- ◆ Preset Curve 5 fades in region 2 slowly at the beginning of the crossfade.



Preset Curve 5

- ◆ Preset Curve 6 fades in region 2 even more slowly than the previous curve.



Preset Curve 6

- ◆ Preset Curve 7 silences region 2 until the end of the crossfade.



Preset Curve 7

## Typical Curve Combinations

Following are the available combinations of fade-out and fade-in curves.

**Linear Crossfade** This is a good general purpose crossfade with a smooth, even transition between region 1 and region 2.

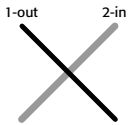

*Linear Crossfade*

**Equal Power Crossfade** This is a good general purpose crossfade useful in cases where a linear crossfade seems to create a noticeable drop in volume across the splice point.

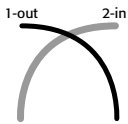

*Equal Power Crossfade*

**Overlap Fade** This combination of curves keeps both regions at full amplitude throughout the crossfade: region 2 “jumps in” at the beginning and region 1 “jumps out” at the end.

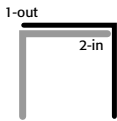

*Overlap Crossfade*

## Fade and Crossfade Preferences

### (TDM Systems Only)

You can set default fade and crossfade settings. These settings load as your “base” settings when you use the Create Fades command, and the Fade to Start and Fade to End commands.

#### To set the crossfade preferences:

- 1 Choose Setups > Preferences and click Editing.
- 2 Set the Pre-Roll and Post-Roll times for Fade previews.

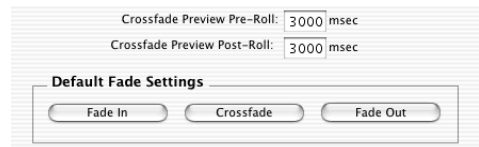

#### Fade and Crossfade Preferences

- 3 Click Fade In and set the default shape for fade-ins, then click OK.
- 4 Click Fade Out and set the default shape for fade-outs, then click OK.
- 5 Click Crossfade and set the default shape for crossfades, then click OK.
- 6 Click Done.

---

## Creating a Crossfade

### To create a crossfade between two regions:

**1** With the Selector, click at the point where you want the crossfade to begin in the first region and drag to where you want it to end in the second region. Crossfade selections can begin and end anywhere in their respective regions.

**2** Choose Edit > Fades > Create Fades.

– or –

Press Control+F (Windows) or Command+F (Macintosh).

**3** Use the view buttons to adjust the view of the crossfade. It may take a few moments to calculate the waveform display for long selections.

**4** Select an Out Shape and an In Shape.

**5** Choose a Linking option.

**6** Click the Audition button, or play the session, to hear the crossfade. For long crossfades, it may take Pro Tools a few moments to calculate and load the audio into playback RAM.

**7** Adjust the curves by choosing different preset shapes with the Out Shape and In Shape pop-up menus.

– or –

Drag the Fade In/Out curves to a custom shape. By choosing None as the Linking option, you can drag the beginning or end points of a fade curve to adjust its beginning or end point.

**8** Click the Audition button, or play the session, to hear the crossfade again.

**9** When the crossfade is right, click OK. The fade is calculated and written to disk, but the audio files and regions remain unchanged. Crossfades are stored in the Fades Folder within the session folder.



*Crossfade lengths can later be resized with the Trimmer.*

### To remove a crossfade:

■ Select the area of the track containing the crossfades you want to delete and choose Edit > Fades > Delete Fades.

– or –

■ Select the crossfade with the Grabber and press Backspace (Windows) or Delete (Macintosh).

### To trim a crossfade:

**1** Select the crossfade with the Grabber, or double-click it with the Selector.

**2** With the Trimmer, trim either side of the crossfade. The crossfade is recalculated to reflect the newly trimmed length.

## Pre and Post Crossfade Selections

By making a selection that begins or ends precisely on the border of two regions, you can create “pre” or “post” crossfades. Use the Tab key to place the insertion point at the exact beginning or end of a region.

### To create a pre- or post-crossfade:

- 1 With the Selector, click in the track that contains the regions you want to crossfade.
- 2 Press Tab to move forward to the next region boundary.  
– or –

Press Control+Tab (Windows) or Option+Tab (Macintosh) to move back to the previous region boundary.

- 3 Shift-drag to adjust your selection, or press Shift+Tab to extend the selection forward to the next region boundary.  
– or –

Press Control+Shift+Tab (Windows) or Option+Shift+Tab (Macintosh) to extend the selection back to the previous region boundary.

- 4 Choose Edit > Fades > Create Fades.  
– or –

Press Control+F (Windows) or Command+F (Macintosh).

- 5 Choose a fade type and click OK.

---

## Creating Fades at the Beginnings and Ends of Regions

In addition to crossfades between regions, Pro Tools lets you create fade-ins and fade-outs at the beginnings and ends of regions.

On Pro Tools TDM systems, you can also use an automatic fade-in/out option, which applies *real time* fade-ins/outs to all regions during playback. These fades are not written to disk, but automatically applied during playback. See “Using AutoFades” on page 305.

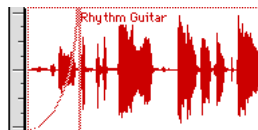

Region with a fade-in

## Creating Fade-Ins and Fade-Outs

Depending on how you make the selection, you can position a fade-in/out at the exact beginning or end of a region, or position it so it extends into a blank area of the track. The length of the selection in the region determines the length of the fade-in/out.

You can also fade to the beginning or end of a region from an insertion point.

### To create a fade-in:

1 Select the beginning of the region that you want to fade in. The selection must extend to the exact beginning of the region or a blank area prior to the region in the track.

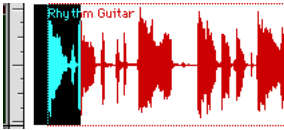

Selecting the beginning of a region for a fade-in

2 Choose Edit > Fades > Create Fades.

– or –

Press Control+F (Windows) or Command+F (Macintosh).

3 Choose the fade-in curve and other settings.

4 Click the Audition button to hear the fade (or press the Spacebar to start and stop playback).

5 You can adjust the curve by dragging it or by choosing a different shape with the In Shape pop-up menu.

6 When you are finished, click OK. Pro Tools calculates the fade and writes it to disk. The chosen fade curve appears in the region.

### To create a fade-out:

1 Select the end of the region that you want to fade out. The selection must extend to the exact end of the region or a blank area after the region in the track.

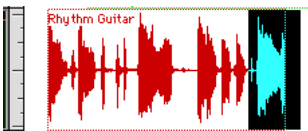

Selecting the end of a region for a fade-out

2 Choose Edit > Fades > Create Fades.

– or –

Press Control+F (Windows) or Command+F (Macintosh).

3 Choose the fade-out curve and other settings.

4 Click the Audition button to hear the fade (or press the Spacebar to start and stop playback).

5 You can adjust the curve by dragging it or by choosing a different shape with the Out Shape pop-up menu.

6 When you are finished, click OK. Pro Tools calculates the fade and writes it to disk. The chosen fade curve appears in the region.

 *Fade lengths can later be resized with the Trimmer.*

### To fade from the insertion point to a region start point:

1 Place the cursor at a location in the region.

2 Choose Edit > Fades > Fade To Start.

– or –

Press Start+D (Windows) or Control+D (Macintosh).

The fade is applied based on the Fade In Preferences.

### To fade from the insertion point to a region end point:

1 Place the cursor at a location in the region.

2 Choose Edit > Fades > Fade To End.

– or –

Press Start+G (Windows) or Control+G (Macintosh).

The fade is applied based on the Fade Out Preferences.



---

## Using AutoFades

### (Pro Tools TDM Only)

On Pro Tools TDM systems, you can choose to have Pro Tools automatically apply real-time fade-ins and fade-outs to all region boundaries in the session. These fade-ins and fade-outs are performed during playback and do not appear in the Edit window, and are not written to disk.

This automatic fade-in/out option also has an effect on virtual track switching in a session. Whenever a lower-priority virtual track “pops thru” a silence in a higher-priority track on the same voice, a fade-in and fade-out is applied to the transition.

This feature is especially useful in post production situations such as dialogue tracking. For example, you could assign both a dialogue track and a “room tone” track with matching background to the same voice. You could then set the Auto-Fade option to a moderate length (4 ms or so) so that whenever a silence occurred in the dialog, playback would switch smoothly to and from the background track without clicks or pops.

Using automatic fade-ins/outs saves you the trouble of editing to zero-crossings or creating numerous rendered fades in order to eliminate clicks or pops in playback. However, since these autofades are not written to disk, those clicks or pops still exist in the underlying sound file. Consequently, those anomalies still appear if the Duplicate AudioSuite plug-in or the Export Selected as Sound Files command (from the Audio Regions List) are used to duplicate multiple regions as a continuous file. To render these real-time auto fades to disk, choose File > Bounce to Disk.

### To set the length of automatic fade-ins/outs:

- 1 Choose Setups > Preferences and click Operation.
- 2 Enter a value between 0 and 10 ms for the Auto Region Fade In/Out Length. A value of zero (the default) means that no auto-fading will occur.
- 3 Click Done. The Auto Fade value is saved with the session, and is automatically applied to all free-standing region boundaries until you change it.

---

## Creating Fades and Crossfades in Batches

In “Batch mode” you can create many fades at once. You select across several regions and use the Create Fades command to create crossfades for each region transition. If your selection includes regions that already have crossfades, this feature allows you to modify them.

### To create crossfades between multiple regions at once:

- 1 With the Selector, click in the first region in which you want to create a crossfade.
- 2 Drag to extend the selection to the last region you want to crossfade. Make sure that the selection includes the entire region.

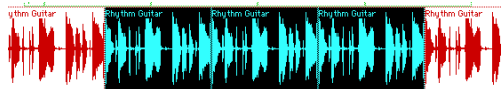

*Selected regions for Batch Fades*

- 3 Choose Edit > Fades > Create Fades.  
– or –

Press Control+F (Windows) or Command+F (Macintosh).

4 Select whether you want to Create New Fades, Create New Fade-Ins & Outs, Adjust Existing Fades, or a combination of these options.

If you select to create new fades *and* new fade-ins and outs, new crossfades are created at each region boundary that is bordered by another selected region, a fade-in is created at the start of the first region, and a fade-out is created at the end of the last region.

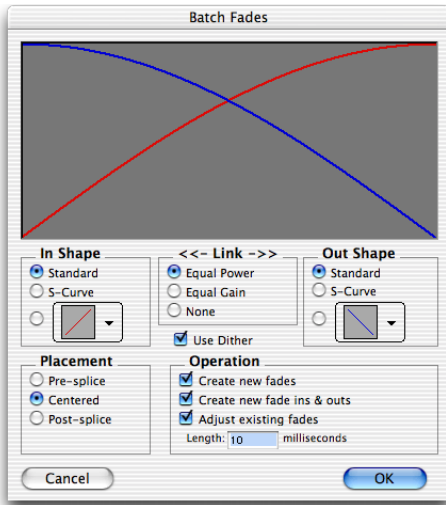

#### *Batch Fades dialog*

5 Choose the placement of your Fades. You can choose Pre-Splice, Centered, or Post-Splice.

6 Enter a crossfade length in milliseconds.

7 Click OK. Pro Tools creates the fades for the selected regions.

 *Fade lengths can later be resized with the Trimmer.*

# Chapter 20: Managing Regions

Managing the regions in a session lets you keep system and storage requirements to a minimum, and simplify archiving requirements. This chapter describes several tools available to manage files and regions in Pro Tools sessions.

 For more information on file management see the *DigiBase Guide*.

---

## Stripping Silence from Regions

The Strip Silence command analyzes audio selections—across multiple regions or multiple tracks—and removes any areas of silence, dividing the selection into smaller regions and removing the silent areas.

You can use Strip Silence to automatically divide a track into regions, which is useful if you want to quantize audio to musical values, or locate sound effects to SMPTE locations. It is also useful if you want to get rid of silent areas to prepare for compacting audio (see “Use this “power delete mode” with caution, since deletion of these files cannot be undone.” on page 313).

## The Strip Silence Window



*Strip Silence window*

The Strip Silence window contains the following four slider controls that allow you to set the parameters by which *silence* will be defined for this operation. Adjusting these controls will cause rectangles to appear in the selection (see Figure 15 on page 308), indicating areas of silence that will be removed.

**Strip Threshold** Sets the amplitude threshold (from -48 dB to 0 dB) for Strip Silence. Audio falling below this threshold is considered silence and removed. Audio above the threshold is retained and defined as new regions.

**Minimum Strip Duration** Sets the minimum duration (from 0 to 10,000 ms) that the material below the threshold must last to be considered silence.

Use this control to avoid countless small regions that may occur within a selection.

**Region Start Pad** Specifies a time value to be added to the beginning of each new region created with Strip Silence. This is useful for preserving musical material that falls below the threshold, such as the breath before a vocal phrase, or the finger slide before a guitar chord.

**Region End Pad** Specifies a time value to be appended to the end of each new region created with Strip Silence, thereby preserving the nuances in the decay of the material.

## Auto-Naming for Strip Silence

The Rename button in the Strip Silence window opens the Rename Selected Regions dialog, which determines how regions are named with the Strip Silence command.

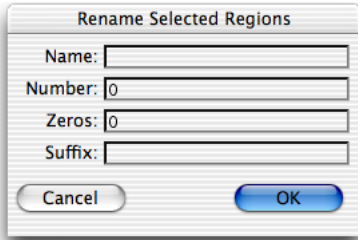

*Rename Selected Regions dialog*

**Name** Specifies the base name for regions created with Strip Silence.

**Number** Specifies the number at which sequential auto-numbering starts.

**Zeros** Specifies the number of zeroes that occur before the appended auto numbers.

**Suffix** Specifies text appended to the end of the name, after the auto numbering.

For example, if you set these naming options to:

- Name = SFX
- Auto Number Start = 23
- Leading Zeros = 1
- Suffix = .Reel1

The names generated for regions created by Strip Silence would be:

- SFX023.Reel1
- SFX024.Reel1
- SFX025.Reel1
- SFX026.Reel1
- SFX027.Reel1
- SFX028.Reel1

## Using Strip Silence

**To strip silence from an audio selection:**

- 1 Select one or more audio regions.
- 2 To select across multiple tracks, Shift-click in additional tracks.
- 3 Choose Windows > Show Strip Silence.
- 4 To set the naming scheme for regions created with Strip Silence, click Rename to open the Renaming dialog. For details, see “Auto-Naming for Strip Silence” on page 308.
- 5 In the Strip Silence window, adjust the sliders for Strip Threshold and Minimum Strip Duration until the Strip Silence rectangles appear in the selection.

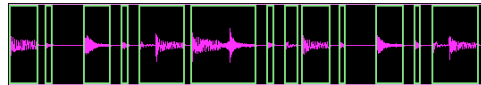

*Figure 15. Strip Silence rectangles*

For finer resolution on these sliders, press Control (Windows) or Command (Macintosh) while adjusting them.

- 6 To retain material before and after the new regions, adjust the sliders for Region Start Pad and Region End Pad.

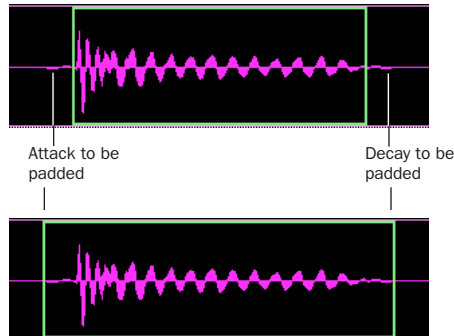

*Strip Silence, padding region start and end points*

**7** Once the Strip Silence rectangles encompass the audio that you want to keep, press the Strip button.

The material defined as silence is removed from the selection and new regions are created, which also appear in the Audio Regions List.

The Strip Silence command is nondestructive and does not remove audio data from parent audio files. In addition to the Undo command, you can use the Heal Separation command to restore stripped material.

 *Strip Silence works with stereo and multi-channel tracks, and keeps their audio regions phase-coherent.*

---

## Inserting Silence

The Insert Silence command is a simple and convenient way to insert silence in sessions. This command allows you to make a selection on a track (or tracks) and insert precisely that amount of silence. In Shuffle mode, all data on the track is shuffled later in the track by an amount equal to the selection.

In Grid mode, the Insert Silence command works just like the Clear command.

**Shuffle Mode** When inserting silence on multiple tracks in Shuffle mode, the following conditions apply:

- ◆ If any track is displayed as audio or MIDI data, the selected duration of silence is inserted into the audio or MIDI data and all underlying automation data on all selected tracks. All subsequent regions are shuffled by the amount of silence inserted. On MIDI tracks, only notes that are selected from the beginning are affected, so if you have selected the tail of a note and you Insert Silence, the note will remain unchanged.

- ◆ If all selected tracks are displayed as automation data, the selected range is cleared of automation data only of the type visible on each track. Regions are *not* shuffled. Instead, a blank gap appears equal to the length of the selection.

- ◆ If all selected tracks are displayed as automation data, press the Start key (Windows) or Control (Macintosh) while choosing the Insert Silence command to insert silence on all automation playlists for all selected tracks. Regions are *not* shuffled.

**Slip Mode** When inserting silence on multiple tracks in Slip mode, the following conditions apply:

- ◆ If any track is displayed as audio or MIDI data, the selected range is cleared of audio or MIDI data and all underlying automation data on all selected tracks.

- ◆ If all selected tracks are displayed as automation data, silence is inserted only into the automation type visible on each track.

- ◆ If all selected tracks are displayed as automation data, press the Start key (Windows) or Control (Macintosh) while choosing the Insert Silence command to insert silence on all automation playlists for all selected tracks.

### To insert silence into a track:

- 1** Make a selection in a track or tracks. The length of the selection determines the duration of the silence inserted.
- 2** Choose Edit > Insert Silence.

For Shuffle mode, Pro Tools inserts the selected amount of silence. In the process, it splits the regions at the beginning of the insertion point, and moves the new regions later in the track by an amount equal to the length of the selection.

---

## Consolidate Selection Command

During the course of normal edit operations, a track may eventually contain many regions. However, once a track or track range (such as a verse or chorus) reaches a satisfactory state, you may want to consolidate its regions into a single region—thus making the material much more easy to work with.

When consolidating an audio track, a new audio file is written that encompasses the selection range, including any blank space.

**⚠** *Consolidating an audio track does not consolidate underlying automation data. To create a single file with automation data applied to the audio, use Bounce to Disk (see “Bounce to Disk” on page 482).*

### To consolidate regions within a track:

**1** Using the Grabber or Selector, select the regions you want to consolidate.

– or –

To select all regions in a track, triple-click in its playlist with the Selector.

**2** Choose Edit > Consolidate Selection.

A new, single region is created that replaces the previously selected regions, including any blank space. If working with an audio track, a new audio file is written (with the Audio Suite Duplicate plug-in).

When consolidating audio regions with the Consolidate Selection command, if the selection contains muted regions, the muted regions are treated as silence. Whether or not a track is muted, or contains Mute automation, does not affect the Consolidate Selection command.

---

## Compacting an Audio File

The Compact Selected command deletes unused portions of audio files to conserve disk space, and to prepare for cleaner hard drive back-ups.

The Compact Selected command deletes audio if there are no regions referencing the data. For this reason you should delete any unused regions before compacting.

Because it permanently deletes audio data, the Compact Selected command should be used only after you have completely finished your editing and are sure that you have no further use for the unused audio data.

The Compact Selected command can *pad* the regions of the compacted file by a user-selectable amount. You may want to do this because Pro Tools requires extra audio data before and after audio regions to create crossfades. So, if your regions have crossfades, or if you want to pad the regions for the sake of any future trimming, you should enter an appropriate amount of padding (in milliseconds) to allow for this.

**⚠** *The Compact Selected command is destructive and cannot be undone. It permanently alters the original audio files. There is no way to recover data deleted with this command.*

### To compact an audio file:

- 1 Choose Select Unused > Regions from the Audio Regions List pop-up menu. All regions that have not been placed in a track in the current session are highlighted in the Audio Regions List.
- 2 To remove all of these unused audio regions, choose Clear Selected from the Audio Regions List pop-up menu. When the dialog appears, choose Remove.
- 3 In the Audio Regions List, select the region or regions you want to compact.
- 4 Choose Compact Selected from the Audio Regions List menu.
- 5 Enter the amount of padding in milliseconds that you want to leave around each region in the file.
- 6 Click Compact to compact the file or Cancel to cancel the command.

Once the Compact operation has been completed, the session is automatically saved.

---

## Naming and Displaying Regions

A typical session can become quite busy with many tracks and dozens of regions. There are a number of things you can do, however, to keep track of and manage a session's regions, which include:

- Renaming existing regions
- Specifying how auto-created regions are named
- Hiding auto-created regions
- Removing unused regions

## Renaming Regions

In the course of a session you can rename regions to give them more descriptive names, or merely to shorten or simplify an existing name. When renaming a region that was auto-created from an edit, the region becomes a user-defined region and is displayed in the Regions List when auto-created regions are hidden.

Perhaps the easiest way to rename a region, if it resides in a track, is to double-click it with the Grabber. However, if the region does not yet reside in a track, or if you want to rename several regions, use the Rename Selected command.

### To rename one or more regions:

- 1 If you will be renaming an auto-created region, make sure to select Display > Auto-Created Regions.
- 2 Select one or more regions to be renamed in either the Audio or MIDI Regions List.

 *If the Editing Preference for “Regions List Selection Follows Track Selection” is enabled, you can highlight a region in the Regions List by selecting it in a track.*

- 3 Choose Rename Selected from the Regions List pop-up menu.
- 4 When prompted, enter a new name for the region. If a whole-file audio region was selected, specify whether to rename just the region, or both the region *and* the disk file.

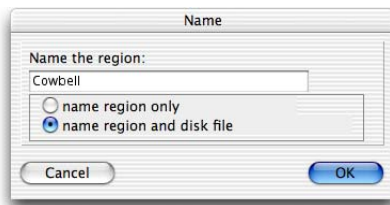

*Rename Selected dialog*

5 Click OK to rename the region. If renaming multiple regions, you are prompted, successively, to rename each region.

## Auto-Naming Options

You can specify the auto-naming options for a region when new regions are created from it in the course of editing.

Auto-naming of regions does not affect the names of parent audio files. Instead, it stores pointers to the regions within the parent source file.

### To set auto-naming options for a region:

- 1 Select a region in the Audio or MIDI Regions List.
- 2 Choose Auto Rename Selected from the Regions List pop-up menu.
- 3 In the Rename Regions dialog, enter the text to be used when naming regions created from the selected region.

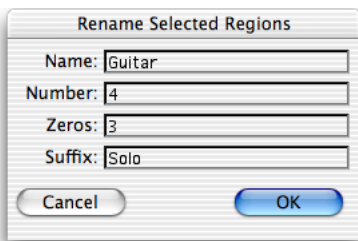

*Rename Regions Selected dialog*

**Name** Determines the root name for the auto-created regions.

**Number** Sets the start number for the sequentially numbered new regions.

**Zeros** Determines the number of zeros that occur before the auto numbers.

**Suffix** Specifies text to be appended to the end of the name, following the auto numbering.

4 When you are finished, click OK to accept the new naming options.

## Hiding and Removing Unwanted Regions

In the course of editing a session, the Audio and MIDI Regions Lists can fill up quickly with regions—ones you've created purposely and those that are automatically created by cutting, pasting, and separating other regions. Pro Tools allows you to hide or remove regions in your session so you don't have to scroll through unnecessarily long Regions Lists.

### Hiding Auto-Created Regions

You can hide regions that were automatically created during the course of editing.

#### To hide auto-created regions:

- Deselect Display > Display Auto-Created Regions. With this option deselected, only user-created regions appear in the Audio and MIDI Regions List.

User-defined regions include:

- Whole-file regions
- Regions created during recording
- Imported regions
- Renamed regions
- Regions created as a result of AudioSuite processing
- New regions created with Capture Region and Separate Region commands
- Regions created by trimming whole-file audio regions



When auto-created regions are hidden, Pro Tools warns you if the number of auto-created regions exceeds a certain threshold, and gives you the option of deleting them. If you choose to delete them, all auto-created regions are deleted at the same time.

To ensure that you keep a particular auto-created region, turn it into a user-created region by renaming it. For details, see “Renaming Regions” on page 311.

## Removing Unwanted Regions

You can locate and remove unused regions in a session with the Clear Selected command.

**⚠** *The Clear Selected command cannot be undone.*

### To find and remove unused regions in a session:

- 1 For MIDI regions, choose Select Unused from the MIDI Regions List pop-up menu.
- 2 For audio regions, choose one of the following from the Select Unused submenu in the Audio Regions List pop-up menu:
  - Unused Regions
  - Unused Regions Except Whole Files
  - Offline Regions
- 3 After all unused regions are selected, choose Clear Selected from the Regions List pop-up menu.
- 4 Click Remove to remove the unused regions from the session.

– or –

If clearing a whole-file audio region and you want to permanently remove the audio file from your hard drive, click Delete.

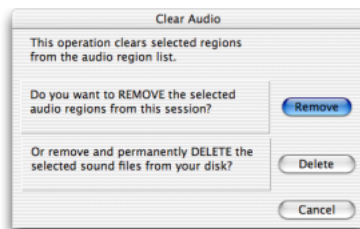

### Clear Selected dialog (audio regions)

When deleting audio files for multiple regions, Pro Tools presents a warning dialog for each audio file.

### To bypass repeated warning dialogs:

- Alt-click (Windows) or Option-click (Macintosh) the Delete button in the Clear Audio dialog. This permanently deletes each successive audio file from your hard drive (for each of the unused regions) without any further warnings.

Use this “power delete mode” with caution, since deletion of these files cannot be undone.



# Chapter 21: Conductor Tracks and Memory Locations

## Tempo Events

Tempo events, which are displayed in the Tempo Ruler, can be inserted at the beginning of a session to replace the default tempo (of 120 BPM), and they can be inserted anywhere within the session for additional tempo changes. Tempo events cannot be inserted in Manual Tempo mode.

### To display the Tempo Ruler:

- Select Display > Ruler View Shows > Tempo.

 *When in Manual Tempo mode, the Tempo Track is ignored and the session plays at the tempo defined in the Transport window. For details, see “Using Manual Tempo Mode” on page 154.*

## Current Tempo

As tempo events are encountered during playback, the session’s current tempo is displayed in the Transport window.



Current tempo displayed in Transport window

## Inserting Tempo Events

### To insert a tempo event:

- 1 Click in the Tempo Ruler where you want to insert the tempo event and then choose MIDI > Change Tempo.

– OR –

Click in the Tempo Ruler where you want to insert the tempo event and then click the Change Tempo button in the far left of the Tempo Ruler.

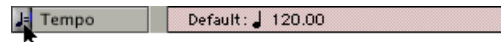

### Change Tempo button

– OR –

While pressing the Start key (Windows) or Control (Macintosh), move the cursor into the Tempo Ruler (where the cursor changes to the Grabber with a “+”) and click at the location where you want to insert the event.



Manually inserting a tempo event

2 In the Tempo Change window, enter the Location and BPM value for the tempo change.

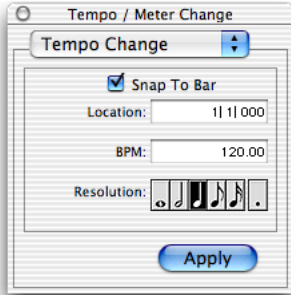

*Tempo Change window*

Select the Snap To Bar option to place the inserted tempo event cleanly on the first beat of the nearest measure.

3 To base the BPM value on something other than the default quarter note, select a different note value.

4 Click Apply. The new tempo event is inserted and appears in the Tempo Ruler.

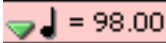

*Inserted tempo event*

Each tempo event has a small green triangle next to it that indicates its location. These triangles can be dragged to move the tempo event, and they can be double-clicked to edit the tempo event.

## Editing and Moving Tempo Events

Existing tempo events can be moved, edited, deleted, and copied and pasted.

### To move a tempo event by dragging:

- In the Tempo Ruler, drag the triangle for the tempo event left or right.

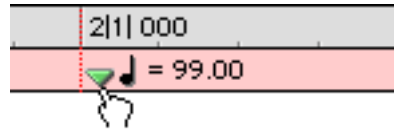

*Dragging a tempo event*

If the Edit mode is set to Grid, the dragged event snaps to the current Grid value.

### To edit a tempo event:

- 1 In the Tempo Ruler, double-click the tempo event.
- 2 In the Change Tempo dialog, enter a new Location or BPM value for the tempo event.
- 3 Click OK.

### To delete a tempo event:

- While pressing Alt (Windows) or Option (Macintosh), move the cursor over the tempo event (where the cursor changes to the Grabber with a “-”) and click to remove it.

### To copy and paste several tempo events:

- 1 If you want to constrain the selection to the current grid value, set the Edit mode to Grid.
- 2 Drag in the Tempo Ruler to select the range of measures that includes the tempo events.



*Tempo events selected*

If an existing tempo event is near the beginning of the selection, press Control (Windows) or Command (Macintosh) so the Selector appears.

💡 *Press Alt (Windows) or Option (Macintosh) while dragging to select across all Conductor tracks.*

- 3 Choose Edit > Copy.
- 4 Click in the Tempo Ruler at the point where you want to paste the tempo events.
- 5 Choose Edit > Paste. The contents of the Clipboard are pasted from the insertion point, replacing any existing tempo events.

#### To extend an Edit selection in a track to the Tempo Ruler:

- 1 Using either the Selector or Grabber, select a track range.
- 2 Shift-click in the Tempo Ruler.

Shift-click again in the Tempo Ruler to remove it from the selection.

#### To select all tempo events:

- Double-click with the Selector in the Tempo Ruler.

#### To clear a range of selected tempo events:

- 1 If you want to constrain the selection to the current grid value, set the Edit mode to Grid.
- 2 Drag with the Selector in the Tempo Ruler to select the tempo events you want to remove.
- 3 Choose Edit > Clear to delete the selected tempo events.

## Tempo and MIDI and Audio

When editing or moving tempo events, the Bars:Beats Ruler expands or shrinks, as necessary, to accurately reflect the placement of audio regions (which remain constant in terms of sample location). This, in turn, affects the relative placement of MIDI notes, and ensures that the visual relationship between MIDI and audio is accurate.

Figure 16 illustrates how MIDI notes shift and expand in relation to audio after the tempo is reduced.

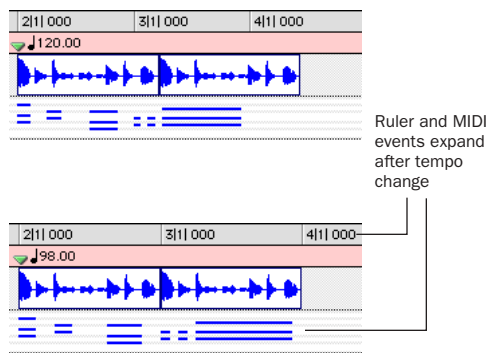

Figure 16. Before and after change in tempo

After editing or moving a tempo event:

- ◆ Bar and beat locations for audio regions (which are sample-based) are adjusted for the new tempo. The audio region's sample and SMPTE locations remain unchanged.
- ◆ MIDI notes (which are tick-based) remain at the same bar and beat location. In relation to audio, however, the notes shrink or expand based on the new tempo, and result in new sample and SMPTE locations for the note start and end times.

---

## Default Tempo

New sessions open with a default tempo of 120 BPM. This tempo can be changed by inserting a tempo event at 1|1|000. However, this is not the same as inserting normal tempo events at other locations. The tempo event that resides at 1|1|000 is actually a Bar|Beat Marker (notice that it has a blue triangle).

The main distinction is that this Bar|Beat Marker can be dragged to any location within the session (such as to align with a particular SMPTE frame) to redefine where 1|1|000 is.

---

## Identify Beat Command

### Bar|Beat Markers

The Identify Beat command lets you establish a tempo/meter map for audio that was recorded without listening to the click, or for imported audio with unknown tempos.

The Identify Beat command analyzes a selection range (usually with a distinct number of beats or measures) and calculates its tempo based on the specified meter. In doing this, Bar|Beat Markers for the calculated tempo are inserted and appear in the Tempo Ruler at the beginning and end of the selection; in addition, meter events are inserted into the Meter Ruler.

 *Pro Tools TDM systems can use Beat Detective to generate Bar|Beat Markers within a selection that includes rhythmic changes on every beat and sub-beat. For more information, see Chapter 22, “Beat Detective.”*

## Bar|Beat Markers

Bar|Beat Markers look similar to tempo events, but instead have small blue triangles to indicate their location.



### Bar|Beat Marker

The key to accurately defining tempos for a range of audio with the Identify Beat command is to make sure that the initial selection represents an accurate length of beats or measures. In fact, you may want to first loop the selection on playback (see “Looping Playback” on page 256) to see if it plays cleanly without skipping. To avoid drift, and remain sample-accurate, select the audio material with the Time Scale set to Samples rather than Bars:Beats.

 *Tempo events and Bar|Beat Markers cannot be mixed. If a session contains tempo events and you attempt to insert Bar|Beat Markers, existing tempo events are converted to Bar|Beat Markers (and vice versa).*

## Identifying Beats

### To add Bar|Beat Markers for a one-bar drum loop:

- 1 Place a one-bar drum loop at the beginning of an audio track.
- 2 Select Display > Samples. This ensures that the selected audio material will be sample-accurate.
- 3 Select the audio region with the Grabber and choose Edit > Identify Beat.

4 In the Bar|Beat Markers dialog, specify the start and end locations for the inserted Bar|Beat Markers. Since this example deals with a one-bar loop, enter 1|1|000 and 2|1|000.

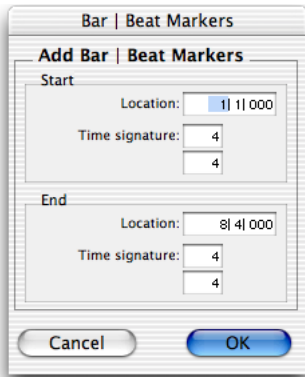

*Identify Beat dialog*

5 If necessary, specify a time signature for the start and end range.

6 Click OK to automatically calculate the new tempo and insert the necessary Bar|Beat Markers and meter events. Any existing tempo and meter events residing within the selection are deleted.

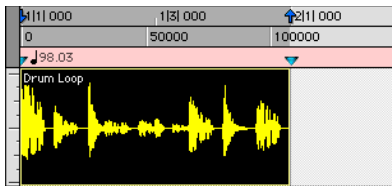

*Bar|Beat Markers inserted*

Once the tempo has been determined for the audio, you can duplicate the original audio region with the Repeat command.

When working with a selection, the Identify Beat command only calculates a single tempo for the selected range. If the tempo varies from measure to measure, or beat to beat, you'll need to use the Identify Beat command for each tempo variance (making sure to accurately define a precise selection range or beat location for the tempo change).

## Inserting Bar|Beat Markers One at a Time

### Audio Material with Varying Tempos

You can insert Bar|Beat Markers one at a time by setting an Edit insertion point (instead of making a selection) before using the Identify Beat command. The ability to identify each beat, one at a time, is especially useful when working with audio with varying tempos.

For instance, if you have a measure that accelerates slightly, you could insert a Bar|Beat Marker on each beat (see Figure 17) so the tempo is accurately reflected.

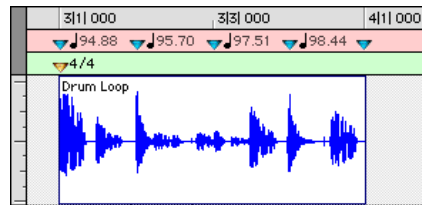
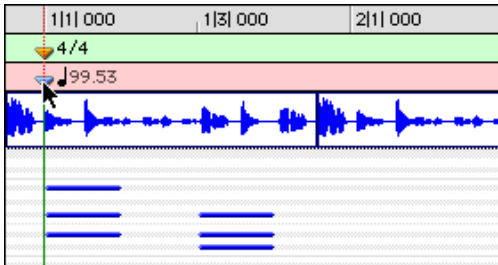

*Figure 17. Bar|Beat Markers on each beat*

After the Bar|Beat Markers are inserted, further adjustments in the tempo map are possible by dragging each of the Markers, as necessary, to align with the associated beat within the audio.

## Dragging Bar|Beat Markers

Bar|Beat Markers can be dragged to new locations so they can align with audio regions that have been moved, or so that they can align to a slightly different point within an audio region. This results in neighboring MIDI data being adjusted to align with the new tempo map.



Dragging a Bar|Beat Marker

## Tempo Events Versus Bar|Beat Markers

Bar|Beat markers and Tempo Events behave differently when you drag them in the Tempo Ruler.

### When dragging a tempo event:

- The tempo event is placed at a new bar and beat location. The sample and SMPTE locations for the event are updated as well.
- The BPM value for the dragged tempo event remains constant, as do any other tempo events in the session.
- Neighboring MIDI events, along with the Ruler, shrink or expand as necessary to adjust for the new tempo location.

### When dragging a Bar|Beat Marker:

- Its BPM value is recalculated along with the Bar|Beat Marker to its immediate left. Bar|Beat Markers to the right of the dragged marker remain unchanged.
- Its bar and beat location is dragged *with* the Bar|Beat Marker. If the Bar|Beat Marker was originally placed at 3|1|000, it remains there (unless it is edited).
- Its sample and SMPTE locations change, as calculated for by the new tempo for the Bar|Beat Marker.
- Neighboring MIDI events, along with the Bars:Beats Ruler, shrink or expand as necessary to adjust for the new tempo.

## Editing Bar|Beat Markers

A Bar|Beat Marker can be edited to redefine its bar and beat location, which also redefines the start or end point of the range being analyzed for tempo. This is different from dragging a Bar|Beat Marker.

### To edit a Bar|Beat Marker:

- 1 In the Tempo Ruler, double-click the Bar|Beat Marker.
- 2 In the Identify Beat dialog, enter a new Location for the Bar|Beat Marker.
- 3 Click OK to recalculate the new tempo.

Like meter and tempo events, Bar|Beat Markers can also be deleted.

### To delete a Bar|Beat Marker:

- While pressing Alt (Windows) or Option (Macintosh), move the cursor over the Bar|Beat Marker (where the cursor changes to the Grabber with a “-”) and click to remove it.



## Meter Events

Meter events can be inserted at the beginning of a session to replace the default meter (of 4/4), and they can be inserted anywhere within the session for additional meter changes. Meter events are displayed in the Meter Ruler.

### To display the Meter Ruler:

- Select Display > Ruler View Shows > Meter.

### Current Meter

As meter events are encountered during playback, the session's current meter is displayed in the Transport window.



current meter

*Current meter displayed in Transport window*

## Inserting Meter Events

### To insert a meter event:

- 1 Choose MIDI > Change Meter.

– or –

Click the Change Meter button in the far left of the Meter Ruler.

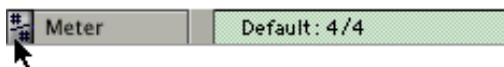

*Change Meter button*

– or –

While pressing the Start key (Windows) or Control (Macintosh), move the cursor into the Meter Ruler (where the cursor changes to the Grabber with a “+”) and click at the location where you want to insert the event.

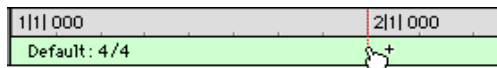

### Manually inserting a meter event

- 2 In the Meter Change window, enter the Location and Meter for the meter change.

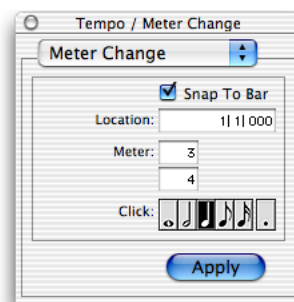

### Meter Change window

Select the Snap To Bar option if you want the inserted meter event to fall cleanly on the first beat of the nearest measure.

- 3 Select a note value for the number of clicks to sound in each measure. For a dotted-note click value, select the dot (.) option.

 For some meters, it may be desirable to use a dotted value for the click. For instance, if using a meter of 6/8, a dotted quarter note click (yielding two clicks per measure) is generally more suitable than a straight eighth note click (six clicks per measure).

4 Click Apply to insert the new meter event. The new meter event is inserted and appears in the Meter Ruler.

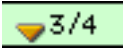

*Inserted meter event*

Each meter event has a small yellow triangle next to it that indicates its location. These triangles can be selected for copying and pasting, and they can be double-clicked to edit the meter event.

## Editing Meter Events

Existing meter events can be edited, deleted, and copied and pasted.

### To edit a meter event:

- 1 In the Meter Ruler, double-click the meter event.
- 2 In the Change Meter dialog, enter a new Location or Meter for the event.
- 3 Click OK.

### To delete a meter event:

- While pressing Alt (Windows) or Option (Macintosh), move the cursor over the meter event (where the cursor changes to the Grabber with a “-”) and click to remove it.

### To copy and paste several meter events:

- 1 If you want to constrain the selection to the current grid value, set the Edit mode to Grid.
- 2 Drag in the Meter Ruler to select the range that includes the meter events.



*Meter events selected*

If the beginning of the selection includes a meter event, press Control (Windows) or Command (Macintosh) so the Selector tool appears.

 Press Alt (Windows) or Option (Macintosh) while dragging to select across all Conductor tracks.

- 3 Choose Edit > Copy.
- 4 Click in the Meter Ruler at the point where you want to paste the meter events.
- 5 Choose Edit > Paste. The contents of the Clipboard are pasted from the insertion point, replacing any existing meter events.

### To extend an Edit selection in a track to the Meter Ruler:

- 1 Using either the Selector or Grabber, select a track range.
- 2 Shift-click in the Meter Ruler.

Shift-click again in the Meter Ruler to remove it from the selection.

### To select all meter events:

- Double-click with the Selector in the Meter Ruler.

### To clear a range of selected meter events:

- 1 If you want to constrain the selection to the current grid value, set the Edit mode to Grid.
- 2 Drag in the Meter Ruler to select the meter events you want to remove.
- 3 Choose Edit > Clear to delete the selected meter events.

## Partial Measures

### Aligning Beat 1 to a SMPTE Location

When scoring to film or video, you will often need to start a section of music at a precise SMPTE time code location. Since this location will usually not fall cleanly at the beginning of a measure, you can insert a meter event at the time code location where the music needs to start.

As necessary, Pro Tools will create a partial measure to accommodate the inserted meter event. When a meter event is preceded by a partial measure, the meter event is displayed in italics in the Meter Ruler.

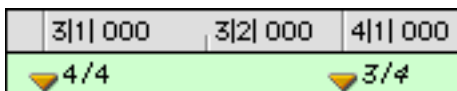

*Partial measure of 4/4*

Partial measures can also occur when pasting meter events to locations other than beat one.

## Renumbering Bars

You can use the Renumber Bars command to renumber all bars in the session, effectively changing the bar locations for all regions, meter and tempo events while leaving their position intact. In doing so, however, the SMPTE and sample locations of the session data are not changed.

### To renumber bars:

- 1 Choose MIDI > Renumber Bars.
- 2 Specify the bar you want to renumber, along with the new bar number, then click Renumber.

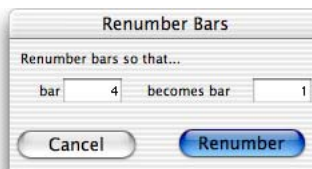

*Renumber Bars dialog*

---

## Memory Locations and Markers

Each session can save up to 200 Memory Locations that can be used to recall:

- Markers to important locations in the session
- Edit selections across one or more tracks
- Record and play ranges, along with pre- and post-roll times
- Track settings that include Show/Hide status, Track Heights, and zoom values
- Edit and Mix Groups enables

Memory Locations are viewed and sorted in the Memory Locations window, where they can be recalled by clicking the Memory Location.

 *With the Numeric Keypad Mode set to Classic, Memory Locations can be recalled from the numeric keypad by pressing the Memory Location number followed by period (.).*

 *With the Numeric Keypad Mode set to Transport or Shuttle, Memory Locations can be recalled from the numeric keypad by pressing period (.), the Memory Location number, and period (.) again.*

## Properties of Memory Locations

When creating a new Memory Location (see “Creating Memory Locations” on page 326) you are prompted to define its *Time Properties* and *General Properties*.

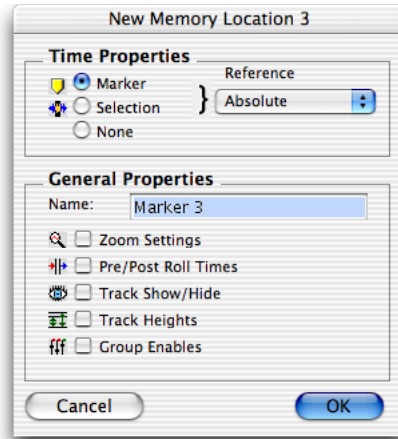

*Memory Location dialog*

### Time Properties

Under Time Properties, a Memory Location can be set to Marker, Selection, or None. This determines the type of Memory Location that is created. Each of these three Memory Location types can also save any combination of General Properties.

**Marker** Recalls a Timeline location whose reference can be either Bar|Beat (tick-based) or Absolute (sample-based). When recalling a *Marker Memory Location*, the playback cursor moves to the Marker’s location and the start and end times in the Transport window are also updated. If the Edit and Timeline Selections are linked, the edit cursor also moves to the Marker location.

Markers appear in the Markers Ruler with a thin yellow line extending down through all tracks in the Edit window (to assist in arranging and aligning track material). You can click a Marker in the Markers Ruler to recall its location along with its stored General Properties.

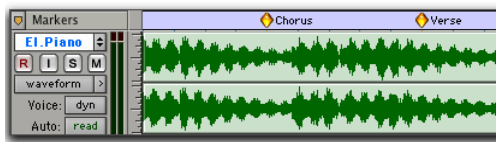

### Markers in the Markers Ruler

**Selection** Recalls an edit selection or edit cursor location whose reference can be either Bar|Beat (tick-based) or Absolute (sample-based). A *Selection Memory Location* lets you store edit selections, for one or more tracks, that you return to often within a session. If the Edit and Timeline Selections are linked, a Selection Memory Location can recall record and play ranges.

 *Only contiguous selections can be saved with Memory Locations. Discontiguous selections, made with the Object Grabber, will be recalled as if the selections were made with the Time Grabber.*

**None** Recalls no Time Properties and is therefore referred to as a *General Properties Memory Location*.

### Bar|Beat and Absolute Reference

The Reference pop-up determines whether the Marker or Selection Memory Location is Bar|Beat or Absolute. When set to Bar|Beat, the Memory Location is tick-based and its bar and beat location remains constant if the tempo is changed—though its relation to audio is scaled, resulting in a new sample location.

When set to Absolute, the Memory Location is sample-based and its bar and beat location shifts if the tempo is changed—though its sample location remains constant, along with its relation to audio material.



*Bar|Beat Marker (left) and Absolute Marker (right)*

In the Markers Ruler, Markers that are Bar|Beat appear as yellow chevrons, and Markers that are Absolute appear as yellow diamonds.

## General Properties

Any of the three types of Memory Locations (Marker, Selection, and None) can store and recall any combination of the following General Properties:

**Zoom Settings** Recalls the horizontal and vertical zoom values for both audio and MIDI tracks.

**Pre- and Post-Roll Times** Recalls pre- and post-roll times (but not whether they are enabled). This property can be stored with a Selection Memory Location to recall record and play ranges along with pre- and post-roll.

**Track Show/Hide** Recalls which tracks are hidden. Use this property to display groups of tracks for editing and mixing.

**Track Heights** Recalls all Track Heights. Use this option along with the Zoom Settings option to recall edit environments that are suited for particular tasks, such as editing down to the sample level or trimming MIDI notes.

**Group Enables** Recalls which Edit and Mix Groups are enabled. This option is helpful in recalling groups for particular edit and mixing operations, such as muting all drum tracks or fading a stereo pair.

## Creating Memory Locations

Memory Locations can be created in different ways, based on the type of Memory Location.

When creating Memory Locations, the next available number is assigned to it (1–200). This number is used in recalling the Memory Location from the numeric keypad.

### To create a Marker Memory Location:

- 1 Configure any session settings you will save with the Marker Memory Location, such as zoom settings, pre- and post-roll times, Show/Hide status for tracks, Track Heights, and Edit and Mix Group enables.
- 2 Make sure to select Operations > Link Edit and Timeline Selection.
- 3 If the Markers Ruler is not displayed, select Display > Ruler View Shows > Markers.
- 4 Click with the Selector in any track or Ruler at the location where you want to place the Marker. To place a Marker at the beginning of a region, select the region with the Grabber. Click the Marker Well button to the left of the Markers Ruler (or press Enter on the numeric keypad).

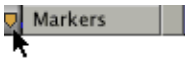

*Marker Well button*

– or –

While pressing the Start key (Windows) or Control (Macintosh), move the cursor into the Markers Ruler (where the cursor changes to the Grabber with a "+") and click at the location where you want to place the Marker.



*Manually inserting a Marker*

5 In the New Memory Location dialog, select the Marker option and specify the Reference as either Bar|Beat or Absolute.

6 Enter a name for the new Marker and select any General Properties you want to save with the Marker.

7 Click OK. The Marker is created and appears in the Markers Ruler, and in the Memory Locations window.

### To create a Selection Memory Location:

1 Configure any session settings you will save with the Selection Memory Location, such as zoom settings, pre- and post-roll times, Show/Hide status for tracks, Track Heights, and Edit and Mix Group enables.

2 Select a range of material in one or more tracks.

3 Press Enter on the numeric keypad.

– or –

From the pop-up menu in the Memory Locations window (click the Name button), choose Add Memory Location.

4 In the New Memory Location dialog, select the Selection option and specify the Reference as either Bar|Beat or Absolute.

5 Enter a name for the new Memory Location and select any General Properties you want to save with it.

6 Click OK. The Selection Memory Location is created and appears in the Memory Locations window.

### To create a General Properties Memory Location:

- 1 Configure any session settings you will save with the Selection Memory Location, such as zoom settings, pre- and post-roll times, Show/Hide status for tracks, Track Heights, and Edit and Mix Group enables.
- 2 Press Enter on the numeric keypad.
- 3 In the Memory Location dialog, select the None option.
- 4 Enter a name for the new Memory Location and select any General Properties you want to save with it.
- 5 Click OK. The General Properties Memory Location is created and appears in the Memory Locations window.



*In the New Memory Location dialog, you can Alt-click (Windows) or Option-click (Macintosh) any General Property to enable or disable all properties. You can also Control-click (Windows) or Command-click (Macintosh) any property to toggle its state and the state of all other General Properties.*

### Creating Memory Locations On-the-Fly

When the Editing Preference for “Auto-Name Memory Locations When Playing” is enabled, Memory Locations can be created during playback, without raising the New Memory Location dialog. This option can also be selected from the pop-up menu in the Memory Locations window.

This capability is useful if you want to mark certain locations while listening during a record pass, or if you want to mark frame locations while viewing a video scene.

### To create a Marker during playback:

- 1 From the pop-up menu in the Memory Locations window, select Default To Marker. This ensures that new Memory Locations default to being Markers.
- 2 From the pop-up menu in the Memory Locations window, select Auto-Name Memory Locations.
- 3 For inserted Markers to have a Bar|Beat reference, make sure to set the Time Scale to Bars:Beats.
- 4 Click Play in the Transport window.
- 5 When the location is reached, press Enter on the numeric keypad. A Marker is automatically created and appears in the Markers Ruler.

Auto-created Markers are named with increasing numbers, as in “Marker 1,” “Marker 2,” and “Marker 3.”

When the option for Default To Marker is deselected, new Memory Locations default to whatever type was last created. Therefore, if a Selection Memory Location was created last, it will be the type that is created on-the-fly. In this case, the name for the created Memory Location is based on the start of the Edit selection using the time format for the Main Time Scale (such as “2|2|305” or “0:02.658”).

## Recalling Memory Locations

Memory Locations can be recalled from the Memory Locations window and from the numeric keypad. In addition, Marker Memory Selections can be recalled by clicking them in the Markers Ruler.

### To recall a Memory Location:

- 1 If the Memory Locations window is not already open, choose Windows > Show Memory Locations to display it.
- 2 If recalling a Selection Memory Location that will define a record or play range, make sure to select Operations > Link Edit and Timeline Selection.
- 3 In the Memory Locations window, click the Memory Location to recall it.

– or –

With the Numeric Keypad Mode set to Classic, press the Memory Location number followed by period (.).

– or –

With the Numeric Keypad Mode set to Transport or Shuttle, press period (.), the Memory Location number, and period (.) again.

 *When recalling a Memory Location from the numeric keypad, the Memory Locations window does not need to be open.*

### To recall a Marker from the Markers Ruler:

- 1 If the Markers Ruler is not displayed, select Display > Ruler View Shows > Markers.

- 2 Click the Marker. The playback cursor locates to the Marker and any General Properties stored with the Marker are recalled.

 *Even if the Markers Ruler is not displayed, Markers can be recalled from the Memory Locations window, or from the numeric keypad.*

## Editing Memory Locations

Memory Locations can be renamed, edited, deleted, and copied and pasted.

### To rename a Memory Location:

- 1 In the Memory Locations window, double-click the Memory Location you want to rename.

– or –

If renaming a Marker Memory Location, double-click the Marker in the Markers Ruler.

- 2 Enter the new name for the Memory Location, and click OK.

### To redefine the General Properties stored with a Memory Location:

- 1 Make changes to the session's zoom settings, pre- and post-roll times, Show/Hide status of tracks, Track Heights, or Group Enables.
- 2 In the Memory Locations window, Right-click (Windows) or Control-click (Macintosh) the Memory Location you want to redefine.

– or –

If changing a Marker Memory Location, Right-click (Windows) or Control-click (Macintosh) the Marker in the Markers Ruler.

- 3 In the Memory Location dialog, select the General Properties you want to save with the Memory Location.
- 4 Enter a new name for the Memory Location, if desired, and click OK.



**To change a Memory Location from one type to another:**

- 1 In the Memory Locations window, double-click the Memory Location you want to change.  
– or –

If changing a Marker Memory Location, double-click the Marker in the Markers Ruler.

- 2 In the Memory Location dialog, select either Marker, Selection, or None as the Memory Location type.
- 3 Enter a new name for the Memory Location, if desired, and click OK.

**To change the Selection stored with a Memory Location:**

- 1 If the Memory Locations window is not already open, choose Windows > Show Memory Locations to display it.
- 2 Select a range of material in one or more tracks.
- 3 In the Memory Locations window, Right-click (Windows) or Control-click (Macintosh) the Memory Location that you want to redefine.
- 4 Enter a new name for the Memory Location, if desired, and click OK.

**To move a Marker by dragging:**

- 1 In the Markers Ruler, drag the Marker left or right.

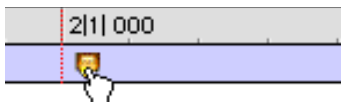

*Dragging a Marker*

If the Edit mode is set to Grid, the dragged event snaps to the current Grid value. If using Spot mode, the Spot dialog opens.

**To align a Marker to a different location:**

- 1 Make sure to select Operations > Link Edit and Timeline Selection.
- 2 In any of the Timebase Rulers, click with the Selector at the new location.  
– or –

Click in the playlist for any track. To align the Marker to the start of a region, select the region with the Grabber.

- 3 In the Memory Locations window or the Markers Ruler, Right-click (Windows) or Control-click (Macintosh) the Marker Memory Location that you want to redefine.
- 4 Enter a new name for the Marker, if desired, and click OK.

**Deleting Memory Locations**

**To delete a Memory Location:**

- In the Memory Locations window, select the Memory Location and choose Delete Memory Location from the pop-up menu.  
– or –
- In the Memory Locations window, Alt-click (Windows) or Option-click (Macintosh) the Memory Location.

**To delete all Memory Locations:**

- In the Memory Locations Window, choose Delete All from the pop-up menu.  
– or –
- Alt-Shift-click (Windows) or Option-Shift-click (Macintosh) any Memory Location in the Memory Locations window.

### To delete a Marker from the Markers Ruler:

- While pressing Alt (Windows) or Option (Macintosh), move the cursor over the Marker (where the cursor changes to the Grabber with a “-”) and click to remove it.

## Copying Marker Memory Locations

### To copy and paste a range of Markers:

- 1 If you want to constrain the selection to the current grid value, set the Edit mode to Grid.
- 2 Drag in the Tempo Ruler to select the range of measures that includes the Markers.

If the beginning of the selection includes a Marker, press Control (Windows) or Command (Macintosh) so the Selector tool appears.

 Press Alt (Windows) or Option (Macintosh) while dragging to select across all Conductor tracks.

- 3 Choose Edit > Copy.
- 4 Click in the Markers Ruler at the point where you want to paste the tempo events.
- 5 Choose Edit > Paste. The contents of the Clipboard are pasted from the insertion point, replacing any existing Markers.

### To extend an Edit selection in a track to the Markers Ruler:

- 1 Using either the Selector or Grabber, select a track range.
- 2 Shift-click in the Markers Ruler.

Shift-click again in the Tempo Ruler to remove it from the selection.

### To select all Markers in the Markers Ruler:

- Double-click with the Selector in the Tempo Ruler.

## Memory Locations Window

Memory Locations are listed, with their name and assigned number, in the Memory Locations window. To recall a Memory Location from this window, simply click it.



Memory Locations window with View Filter icons

You can select viewing and sorting options, along with commands for creating and removing Memory Locations, from the pop-up menu in the Memory Locations window (obtained by clicking the Name button in the upper left).

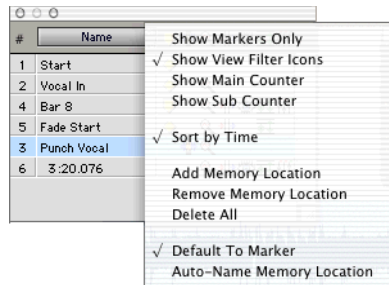

Memory Locations window pop-up menu

## Memory Locations Commands and Options

**Show Markers Only** When selected, only Marker Memory Locations are displayed in the Memory Locations window. However, even when Selection Memory Locations and General Property Memory Locations are hidden, they can still be recalled from the numeric keypad.

**Show View Filter Icons** When selected, the Memory Locations window provides an icon-based “View Filter” that allows you to show or hide Memory Locations based on the properties they contain. To show or hide Memory Locations containing a specific property, click the appropriate icon.

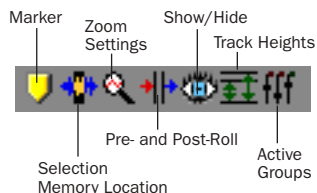

### Memory Locations View Filter

If an icon is disabled, all Memory Locations associated with that property are hidden. However, if a Memory Location contains other properties for an icon that is enabled, it is still displayed. When a view icon is enabled, it appears in color. When it is disabled, it appears gray.

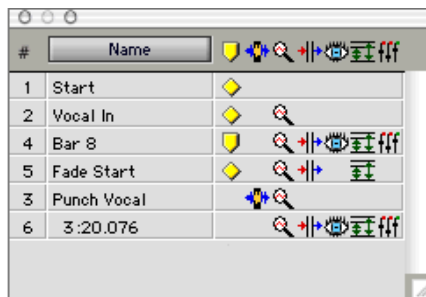

Memory Locations window with View Filter icons

In addition, the View Filter provides a handy reference for which properties are stored in each Memory Location (indicated by a row of icons for each Memory Location).

**Show Main/Sub Counter** When selected, a column appears in the Memory Locations window that displays the locations for Markers, and the start times for Selection Memory Locations. General Property Memory Locations display nothing in this column.

#	Name	Min:Secs	Bars:Beats	View Filter Icons
1	Start	0:30.944	50   3   694	[Yellow Shield]
2	Vocal In	1:02.597	103   2   949	[Yellow Shield], [Magnifying Glass]
4	Bar 8	1:36.376	159   3   848	[Yellow Shield], [Magnifying Glass], [Pre- and Post-Roll], [Show/Hide], [Track Heights]
5	Fade Start	5:04.248	506   2   231	[Yellow Shield], [Magnifying Glass], [Pre- and Post-Roll], [Track Heights]
3	Punch Vocal	2:45.824	275   3   119	[Magnifying Glass], [Pre- and Post-Roll], [Track Heights]
6	3:20.076			[Magnifying Glass], [Pre- and Post-Roll], [Show/Hide], [Track Heights]

### Main/Sub Counters in Memory Locations window

You can click at the top of these columns for a pop-up menu that will let you change the Main and Sub Time Scale.

**Sort by Time** When selected, Markers are sorted by their order in the Timeline, followed by Selection and General Properties Memory Locations, which are listed in the order in which they were created.

When Sort by Time is deselected, all Memory Locations are listed in the order of their assigned numbers.

**Add Memory Location** Choose this command to create a new Memory Location.

**Remove Memory Location** Deletes the currently selected Memory Location in the Memory Locations window.

**Delete All** Deletes all Memory Locations (Marker, Selection, and General Property) in the session.

**Default To Marker** When selected, new Memory Locations default to Markers, though in the New Memory Location dialog you can still define the new Memory Location as one of the other types.

**Auto-Name Memory Location** When selected, Memory Locations are created automatically without encountering the New Memory Location dialog. If the Default To Marker option is selected, a Marker Memory Location is auto-created. Otherwise, the Memory Location type is determined by whatever type (Marker, Selection, or None) was created last.

# Chapter 22: Beat Detective

Beat Detective (TDM systems only) is a powerful tool for analyzing, editing, and manipulating audio with an inherent rhythmic character.

Beat Detective analyzes an audio selection, identifies its peak transients, and generates *beat triggers* based on the detected peak transients. From these beat triggers, Beat Detective can:

- Extract tempo and beat information to create Bar|Beat Markers that can be used to define the session's tempo map. See “Generating Bar|Beat Markers with Beat Detective” on page 341.
- Extract tempo and groove information as groove templates, called DigiGrooves. These templates can be used in Beat Detective to apply to audio (TDM systems only). DigiGroove templates can also be used with Groove Quantize for MIDI data (all Pro Tools systems). See “DigiGroove Templates” on page 342.
- Separate the audio selection into discrete regions, and then conform (or “quantize”) separated regions to the session's tempo map, or to groove templates (Pro Tools 6.x only). See “Separating Regions with Beat Detective” on page 344 and “Conforming Regions with Beat Detective” on page 346.

## Beat Detective and Source Material

Beat Detective is most effective with rhythmic audio material that has strong percussive attacks (including most instruments used in popular music, such as drums, guitar, or bass). Beat Detective will be less successful with audio material with soft attacks, or legato phrasing (such as strings and vocals).

While Beat Detective has intelligent analysis algorithms with extrapolation for detecting rhythmic material, some material may deviate too far from the rhythmic grid, or have tempo or meter changes that are too varied, to be useful with Beat Detective.

## Uses for Beat Detective

Beat Detective can be useful in many situations, including:

**Extracting Tempo from Audio** Beat Detective can generate Bar|Beat Markers, from which it can extract the tempo—even if the audio contains varying tempos, or material with a swing feel. Additionally, once Bar|Beat Markers have been generated, other audio and MIDI regions can be quantized to them.

**Creating DigiGrooves (Pro Tools 6.x Only)** Beat Detective can extract groove templates, called DigiGrooves, from an audio selection. DigiGrooves can be used to apply the groove, or feel of the captured passage to other audio selections (using Groove Conform) or MIDI data (using Groove Quantize).

**Conforming Audio Regions** Beat Detective can conform (“quantize”) audio with a different tempo, or with varying tempos, to the session’s current tempo map, or to a groove template (Pro Tools 6.x only).

**“Tighten Up” Performances** Beat Detective can be used to improve the timing of some audio material by calculating and extracting its average tempo, and then conforming its rhythmic components—regions separated with Beat Detective—to the session’s tempo map.

**Loop Matching** Since Beat Detective can extract tempo and beat information from audio, and conform audio to an existing tempo map or groove template, this makes it very useful for aligning loops with different tempos or grooves. If a loop is at a different tempo than the current session, Beat Detective lets you quickly separate each beat in the loop and conform them to the tempo map (as an alternative to time compressing or expanding the loop, which can alter the pitch and tone of the audio).

**Remixes** Beat Detective can be used for remixes or creating new rhythms. It can extract tempo from the original drum tracks, or in some instances the original stereo mix. New audio or MIDI tracks can then be conformed to the original material, or the original material can be conformed to new drum tracks, achieving an entirely new feel.

**Smoothing Post Production Edits** Beat Detective’s Edit Smoothing can be used to automatically clean up foley tracks that contain many regions requiring trimming and crossfading, effectively removing the gaps of silence between the regions (thus retaining the room tone throughout the track).

---

## Beat Detective Requirements

Beat Detective is only available on Pro Tools TDM systems.

### RAM Requirements for Beat Detective

Beat Detective operations can require a large amount of RAM, especially when working with multiple tracks and lengthy selections.

To avoid low memory situations with Beat Detective, do the following:

- If you begin to experience slower Beat Detective response, add more RAM to your computer.
- If your computer does not have the extra RAM, work with shorter selections, or individual tracks.
- Set the Editing Preference for Levels of Undo to a smaller value (see “Levels of Undo and Memory” on page 220). Memory-intensive editing operations, such as Edit Smoothing with Beat Detective, can use up a large amount of memory when in the Undo queue.

---

## The Beat Detective Window

The Beat Detective window appears as shown in Figure 18, below.

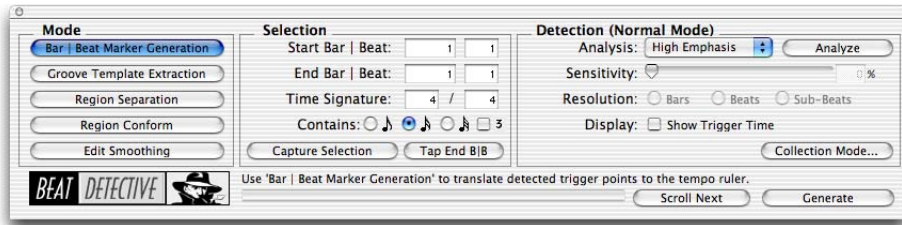

Figure 18. Beat Detective

### To open the Beat Detective window:

- Choose Windows > Show Beat Detective.
  - or –
- Press Control+8 (Windows) or Command+8 (Macintosh) on the numeric keypad.

Beat Detective is a floating window that can be left open while working. This lets you adjust the controls in real time during playback, while viewing the beat triggers that appear in your selection in the Edit window.

---

## Beat Detective Modes

The Beat Detective window is divided into three sections: Mode, Selection, and Detection. Depending on the current mode, the other controls in the window change. The Selection options for Beat Detective are available in each of the modes.

The Beat Detective modes include the following:

**Bar|Beat Marker Generation** Generates Bar|Beat Markers corresponding to transients detected in the audio selection.

**Groove Template Extraction** Extracts the rhythmic and dynamic information from audio, and saves this information to the Groove Clipboard, or as a DigiGroove template.

**Region Separation** Separates and creates new regions based on transients detected in the audio selection.

**Region Conform** Conforms all separated regions within the selection to the current tempo map. In Pro Tools 6.x, Beat Detective can conform audio regions to groove templates (such as DigiGroove templates) in addition to standard quantization.

**Edit Smoothing** Fills the gaps between conformed regions by automatically trimming them, and if you choose, inserts crossfades.

---

## Defining a Beat Detective Selection

Whether you will be generating Bar|Beat Markers, extracting a DigiGroove template, or separating regions to be conformed, you must always define the audio selection to be analyzed. The Beat Detective window provides tools to define and capture the selection range, time signature, and swing (sub-division) content for the selected audio.

 *To ensure the best possible results with Beat Detective, make sure the selected passage starts exactly on the attack of the first beat. Zooming in to the sample level to start the selection will help ensure there is no space before the first beat.*

For Beat Detective to generate beat triggers that are metrically accurate, the length and meter of the selection must be correctly defined. In addition, the selection should not contain any meter or tempo changes.

 *Use Loop playback to check the accuracy of your selection.*

### To define a selection for Beat Detective:

**1** In the Edit window, select a range of audio material in a single track or in multiple tracks.

 *To keep the Edit selection intact while playing or looping from any location, deselect Operations > Link Edit and Timeline Selection.*

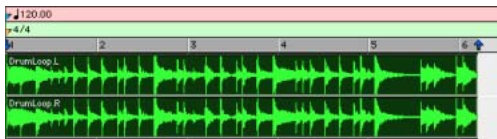

Making an audio selection for Beat Detective

Make sure the selection's start and end points fall cleanly on the beat. To zero in on start and end points, zoom to the sample level and use the Tab to Transients option (see "Tabbing to Transients" on page 254).

 *Save and recall an Edit selection by saving it as a Memory Location. See "Memory Locations and Markers" on page 324.*

**2** Choose Windows > Show Beat Detective.

**3** You must define or capture the selection every time you make a new selection or change the tempo map. To define the selection range, do one of the following:

- If the tempo and meter of the audio selection do not match the session's default tempo and meter, enter the Time Signature, and Start Bar|Beat and End Bar|Beat locations. For a four-bar selection that starts on beat 1, enter 1|1 and 5|1.
- If the tempo and meter of the audio selection do not match the session's default tempo and meter, and you are unsure of the length of the material, enter the Time Signature and the Start Bar|Beat location; then start playback, and click the Tap button repeatedly to automatically calculate the End Bar|Beat. When using Tap with long selections, continue to tap until the End Bar|Beat stabilizes. Once stabilized, you may need to manually adjust the number to the nearest bar boundary.



- If the selection's tempo and meter match the session tempo and meter (see “Calculating Tempo with Beat Detective” on page 337), and it aligns correctly with the session's bars and beats, click the Capture Selection button. The correct Time Signature, and Start Bar|Beat and End Bar|Beat values will be filled in automatically.



*Beat Detective, Selection options*

 *As long as the audio material is correctly aligned with the session's tempo map, use Capture Selection each time you make a new selection or make any changes to the tempo map (such as changing tempo or meter).*

 *The Selection definition is not retained when a session is closed and re-opened*

4 To improve Beat Detective's accuracy in analyzing swung notes, select the Contains option that indicates the smallest sub-division of the beat contained in the selection. The Contains options include eighth-note, sixteenth-note (the default setting), thirty-second-note, and triplet modifier. In Pro Tools 6.x, the selected Contains option determines the groove template grid locations for DigiGroove templates.

## Calculating Tempo with Beat Detective

If you know the meter, and start and end points of the audio selection, use Beat Detective to calculate its tempo.

### To calculate a selection's tempo with Beat Detective:

- 1 Make an audio selection in the Edit window and define the selection in the Beat Detective window as described in “Defining a Beat Detective Selection” on page 336.
- 2 Select Bar|Beat Marker Generation mode.
- 3 In the Detection section (Normal mode), click Analyze.
- 4 Set the Sensitivity slider set to 0%



*Beat Detective, Detection mode*

- 5 Click Generate.

Bar|Beat Markers are automatically generated at the beginning and end of the selection, indicating the material's tempo and meter.

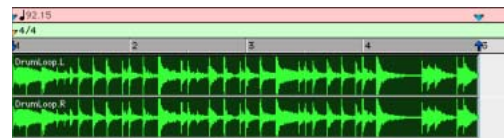

*Beat Detective generated Bar|Beat Markers identifying tempo and meter*

## Generating Beat Triggers

Once you've accurately defined the selection range, Beat Detective can generate beat triggers based on detected peak transients. The range and type of transients found can be adjusted with the Detection settings, allowing you to zero in on the bars, beats, and sub-beats in the material, while avoiding the non-rhythmic content.

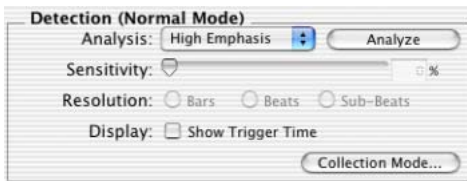

Beat Detective, Detection (Normal mode) options

### To generate beat triggers for the selection:

- 1 In the Edit window, make an audio selection.
- 2 In the Beat Detective window, select one of the following modes:
  - Bar|Beat Marker Generation
  - Groove Template Extraction (Pro Tools 6.x only)
  - Region Separation
- 3 Define or capture the selection as described in “Defining a Beat Detective Selection” on page 336.
- 4 From the Analysis pop-up menu, choose one of the following detection algorithms:
  - High Emphasis, works well with high frequency, inharmonic material, such as cymbals and hi-hats, while avoiding low frequency material.
  - Low Emphasis, works well with low frequency material, such as bass guitar and kick drum, as well as with most harmonic material, such as piano or rhythm guitar.
- 5 Click the Analyze button.

6 Depending on the rhythmic content of the selection, set the Resolution to Bars, Beats, or Sub-Beats.

7 Adjust the Sensitivity slider until beat triggers appear on the beats and sub-beats in the selection.

Bar triggers are indicated with thick lines, beat triggers with medium lines, and sub-beat triggers with thin lines.

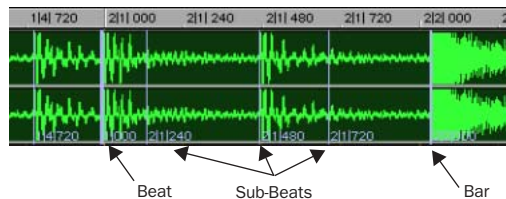

Beat triggers

8 In Pro Tools 6.x, you can zoom to the sample level and click the Scroll Next button to scroll to the next trigger within the selection. To scroll to the previous trigger, Alt-click (Windows) or Option-click (Macintosh) the Scroll Next button (see “Navigating Consecutive Beat Triggers” on page 341). This is useful to confirm that the beat triggers are appearing in the appropriate locations. If *false triggers* appear between the beats or sub-beats (representing non-rhythmic material) delete them (see “Deleting Beat Triggers” on page 339), or reduce the Sensitivity value.

9 To display the metric locations for the triggers, select the Show Trigger Time option.

10 If you cannot get the beat triggers to appear at the right locations, repeat steps 4–9 trying the other Analysis algorithm (High or Low Emphasis). In addition, see the following tips.

## Tips for Getting Useful Beat Triggers

Use the following tips to verify beat triggers:

- ◆ To focus on a particular area in the selection, unlink the Edit and Timeline Selections and set the playback range by clicking or dragging in any Timebase Ruler.
- ◆ Check the thickness of the beat triggers to see if they align properly with the audio material. Thick triggers fall on barlines, medium triggers fall on beats, and thin triggers fall on sub-beats.
- ◆ Select the option for Show Trigger Time and see if the (assumed) metric locations of the triggers align with the material. A false trigger should be moved or deleted because it can cause subsequent triggers to appear in the wrong locations (see “Editing Beat Triggers” on page 339).
- ◆ Consider whether lengthy selections should first be broken down into smaller selections, which could be more easily managed. For example, working in 8- or 4-bar sections might yield better results more quickly.
- ◆ For selections across multiple tracks, consider whether it may be easier to work with them individually, or in Collection mode (see “Detection (Normal) and Collection Mode” on page 349).

## Editing Beat Triggers

Even though Beat Detective offers a great deal of flexibility in how transients are detected, there may be times when beat triggers must be deleted, moved, or manually inserted. Additionally, triggers can be promoted so they are retained at lower sensitivity settings.

### Deleting Beat Triggers

False triggers, which do not represent an actual beat or sub-beat in the source material, may appear when raising the Sensitivity slider to detect quiet material. In these instances you can locate and manually delete any false triggers.

#### To delete a beat trigger:

- 1 With the Beat Detective window open, choose the Grabber tool in the Edit window.
- 2 Locate the false trigger you want to delete. Transients for false triggers usually have smaller peaks than the other trigger points, and typically fall between the sub-beats.

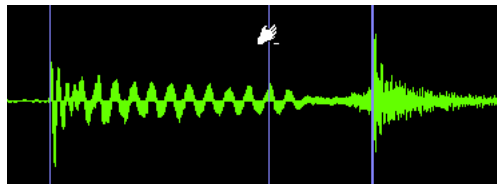

*Deleting a beat trigger*

- 3 Alt-click (Windows) or Option-click (Macintosh) the trigger to delete it.

### Moving Beat Triggers

You can adjust the placement of triggers to allow for the attack of their transients, or to compensate for an individual transient that is slightly ahead of or behind the beat.

### To move a beat trigger:

- 1 With the Beat Detective window open, choose the Grabber tool in the Edit window.
- 2 Locate the beat trigger you want to move and drag it left or right.

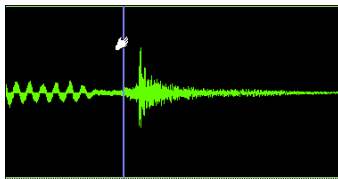
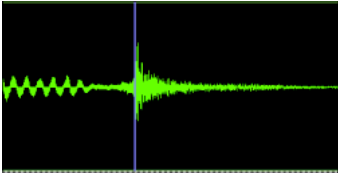

Moving a beat trigger

### Inserting Beat Triggers

If an important beat or sub-beat is not detected, because it is too quiet, you can manually insert a beat trigger.

#### To insert a beat trigger:

- 1 With the Beat Detective window open, choose the Grabber tool in the Edit window.
- 2 Click in the selection where you want to insert the new trigger. After inserting a beat trigger, you can drag it left or right to adjust its placement (see “Moving Beat Triggers” on page 339).

If you click too close to an existing trigger, the existing trigger will be moved to the new location.

### Promoting Beat Triggers

To ensure that important beat triggers do not disappear when lowering the Sensitivity value, you can *promote* them. This is useful if a selection has numerous false triggers (too many to bother deleting) at a Sensitivity level where crucial, necessary beat triggers are also displayed. If lowering the Sensitivity slider causes the needed triggers to disappear, simply promote them first.

#### To promote a beat trigger:

- 1 Raise the Sensitivity slider until the desired transient is detected and a beat trigger appears.
- 2 Control-click (Windows) or Command-click (Macintosh) the beat trigger to promote it.
- 3 If necessary, repeat steps 1–2 to promote additional beat triggers.
- 4 Lower the Sensitivity slider to a value where the false triggers disappear.

Once beat triggers are promoted, they will only disappear if the Sensitivity value is set to 0%. To *demote* all beat triggers in the selection—returning them to their original state—click the Analyze button.

### Redefining a Beat Trigger’s Metric Location

It is vital that beat triggers are accurately placed at the correct metric location. If a detected transient is slightly off the beat, Beat Detective may assign it, as well as other transients in the selection, to the wrong metric location.

For example, if you have a bass track where a note was intended to be a downbeat, but was played too early, Beat Detective may define its location as occurring a little before the down-

beat. If you then separate and conform the region containing this note, it will be moved to the wrong location. Subsequent regions may be moved to the wrong locations as well.

If a beat trigger is not assigned the correct metric location, relocate it using Identify Trigger.

**To change the metric location of a beat trigger:**

- 1 Double-click the beat trigger you want to relocate. The Identify Trigger dialog opens.
- 2 In the Identify Trigger dialog, enter the correct location for the trigger, then click OK.

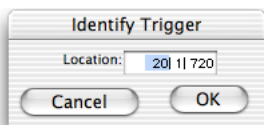

*Identify Trigger dialog*

**Navigating Consecutive Beat Triggers**

Use the Scroll Next button to move from the currently selected beat trigger to the next beat trigger. To move to the previous beat trigger, Alt-click (Windows) or Option-click (Macintosh) the Scroll Next button. This is particularly useful for editing consecutive beat triggers when zoomed in at the sample level.

---

## Generating Bar|Beat Markers with Beat Detective

Once Beat Detective has accurately detected the peak transients in the audio selection and accurately generated beat triggers, the triggers can be converted to Bar|Beat Markers. Bar|Beat Markers generated by Beat Detective create a tempo map that can be used throughout the session.

Once beat triggers are accurately represented according to Bars, Beats, and Sub-Beats, other audio regions and MIDI notes can be conformed to the Bar|Beat Markers generated by Beat Detective.

If you want to match the audio material to the session's existing tempo map or a groove template, do not generate Bar|Beat Markers from the material. Instead, use Beat Detective to separate and conform the material (see "Separating Regions with Beat Detective" on page 344).

**To generate Bar|Beat Markers with Beat Detective:**

- 1 In the Edit window, make an audio selection.
- 2 In the Beat Detective window, select Bar|Beat Marker Generation mode.
- 3 Define or capture the selection as described in "Defining a Beat Detective Selection" on page 336.
- 4 Set the Detection resolution to Bars or Beats, and configure the Detection settings so the selection's peak transients are accurately detected (see "Generating Beat Triggers" on page 338).
- 5 Click the Generate button.

Bar|Beat Markers are generated, based on the beat triggers, and appear in the Tempo Ruler.

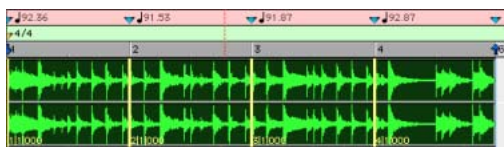

Bar|Beat Markers generated at Bar resolution

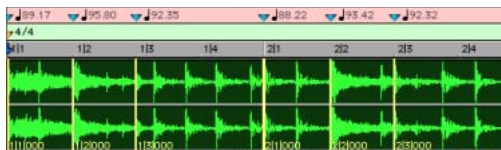

Bar|Beat Markers generated at Beat resolution

## Working with Sub-Beats

Tempo is derived from Bar|Beat Markers. Groove, or feel, is derived from Sub-Beats—the deviation of subdivisions of the beat from the strict tempo grid determines the groove or feel.

To extract the groove from a selection, set the Detection Resolution to Sub-Beats. This ensures that the inner rhythms within each bar (if they indeed exist) are represented when generating Bar|Beat Markers. These Bar|Beat Markers can then be used to quantize other audio regions or MIDI tracks, thereby conforming to the Bar|Beat Markers generated by Beat Detective.

**⚠** *When quantizing regions or MIDI notes to Bar|Beat Markers on sub-beats that represent a swing feel, make sure to use a straight quantize value (with the Swing option for Quantize disabled).*

---

## DigiGroove Templates

Beat Detective allows the fine timing nuances of a rhythmic performance to be extracted and saved as a groove template, called a DigiGroove template. DigiGrooves can be saved locally to the Groove Clipboard, or saved to disk as DigiGrooves.

Groove templates can be used to transfer the feel of a particular performance to:

- Selected audio regions using Groove Conform (see “Groove Conform” on page 347).
- Selected MIDI data using Groove Quantize (see “Groove Quantize” on page 385).

Groove templates are “quantization maps” derived from real musical performances. The rhythmic character of each performance is analyzed and stored as a groove template. Beat Detective analyzes an audio selection for transient peaks according to a defined threshold and maps the rhythmic relationships to a 960 parts per quarter note (ppq) template.

When create DigiGroove templates, Beat Detective also analyzes the dynamics of a performance. Accents and peak levels are incorporated into the groove template as velocity data, which can be applied to change the dynamics of MIDI tracks. Beat Detective translates amplitude to MIDI velocity according to a linear scale. For example, a 0 dBFS signal equals a MIDI velocity of 127, a signal at –6 dBFS equals a MIDI velocity of 64, a signal at –12 dBFS equals a MIDI velocity of 32, and –48 dBFS equals a MIDI velocity of 1.

Capturing this information is very important to preserving the feel of a performance, and can add life to MIDI tracks that lack dynamics.

**⚠** *Beat Detective does not capture duration data.*

### To extract a Groove Template:

1 In the Edit window, make an audio selection. The selection should consist of one or more complete bars, starting and ending on downbeats.

**⚠** *When extracting Groove Templates, the captured selection must not include Bar|Beat Markers. Otherwise, the accuracy of the Groove Template will be compromised.*

2 In the Beat Detective window, select Groove Template Extraction mode.

3 Define or capture the selection as described in “Defining a Beat Detective Selection” on page 336.

4 Configure the Detection options so the selection’s peak transients are accurately detected (see “Generating Beat Triggers” on page 338).

5 Click the Extract button.

6 In the Extract Groove Template dialog, enter comments about the groove. You can enter a maximum of 255 characters to describe the groove. Comments can be viewed using the Show Info button in the Beat Detective window.

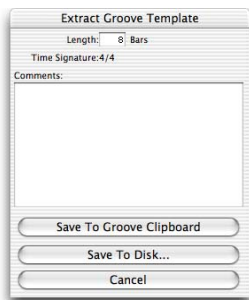

**Extract Groove Template dialog**

7 Do one of the following:

- To save the extracted template for use in the current session, without writing the template file to disk, click Save To Groove Clipboard. (This template will be lost when you close the current session.)
- To save the extracted template to disk in order to use it in other sessions or share it with other Pro Tools users, click Save To Disk. Enter a name for the template and click Save. (Do not change the location of DigiGroove template files and folders or they will not be available in your sessions.)
- Click Cancel to cancel without saving the template.

**💡** *Use folders and subdirectories to organize DigiGroove templates. However, be sure they are always located in Applications/Digidesign/Pro Tools/Groove. Groove template files located elsewhere will not be available in either Groove Quantize or Beat Detective).*

### Swing Content for Generating Groove Templates

When defining swing content of the selection, select the Contains eighth-note option if the audio selection has a heavily swung eighth-note groove. If the audio selection has relatively straight eighth-notes, use the Contains sixteenth-note option. This lets the resultant DigiGroove template be applied more easily elsewhere. Although a groove might be based upon non-swung eighth-note material, you might want to apply the template to material that contains sixteenth-notes. If a template only has eighth-note resolution, but the material being conformed contains sixteenth-notes, adjacent sixteenth-notes will be mapped to the same eighth-note location.



## Groove Extrapolation

Beat Detective's ability to extract tempo data from a wide range of material is enhanced by its powerful "groove extrapolation" logic. Groove extrapolation automatically generates beat triggers for inclusion in groove templates even if a peak transient is not detected. For example, a drum loop might not have a hit on beat 3, consequently no peak transient is detected and no beat trigger is generated. Beat Detective will extrapolate from other beat triggers in the selection and create a trigger for beat 3 in the groove template.

In addition, extrapolated triggers preserve the feel of triggers generated from detected peak transients. For example, if a bar of kick drum detected three beat triggers, all of which were 20 ticks ahead of the beat, any extrapolated beat triggers will also be mapped 20 ticks ahead of the beat.

---

## Separating Regions with Beat Detective

Once beat triggers appear in your selection, they can be used to define start and end points for new regions that can be separated automatically. The new regions can then be conformed to the session's existing tempo map, or to a groove template (Pro Tools 6.x only).

If you want to clean up the timing for the selection, without affecting the tempo, make sure to first calculate the tempo by generating Bar|Beat Markers (see "Calculating Tempo with Beat Detective" on page 337).

### To separate regions with Beat Detective:

- 1 In the Edit window, make an audio selection.
- 2 In the Beat Detective window, select Region Separation mode.
- 3 Define or capture the selection as described in "Defining a Beat Detective Selection" on page 336.
- 4 Configure the Detection options so the selection's peak transients are accurately detected (see "Generating Beat Triggers" on page 338).
- 5 Click the Separate button.

Regions are separated based on the detected beat triggers.

### Trigger Pad

When separating regions, the Beat Detective window displays an option called Trigger Pad.



Detection settings, Region Separation mode

Enter a value (0–50 ms) in this field to pad region start points—where the point of separation is located in relation to the beat trigger (transient). This creates a space between the region start point and the region sync point, thereby ensuring that the attack portion of the material remains intact.

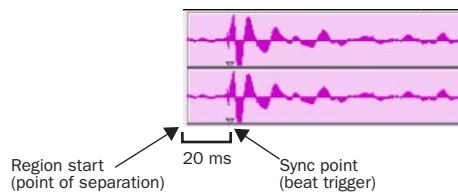

Separated region with 20 ms Trigger Pad



When conforming separated regions, the region sync point, not the region start point, determines where the region is placed.

 For more information on region sync points, see “Defining Region Sync Points” on page 265.

## Separating Multiple Tracks

You can use beat triggers from a single track, or subset of tracks, to separate a group of tracks.

In the following example, the defined selection is a drum loop consisting of two bars of 5/4. The kick, snare, hi-hat, and overhead microphones are recorded to separate tracks.

Analyzing the loop’s kick drum track, with Detection Resolution set to Beats, Beat Detective places beat triggers at the transients on beats 1 and 4 (see Figure 19).

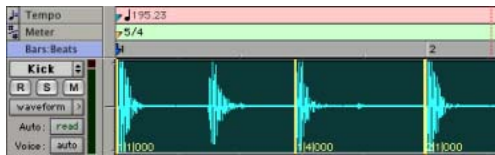

Figure 19. Kick drum track

Extending the selection to the snare, hi-hat, and overhead microphones tracks, and then performing the separation, results in separated regions in each of the drum tracks at the same location, based on the beat triggers from the kick drum track (see Figure 20).

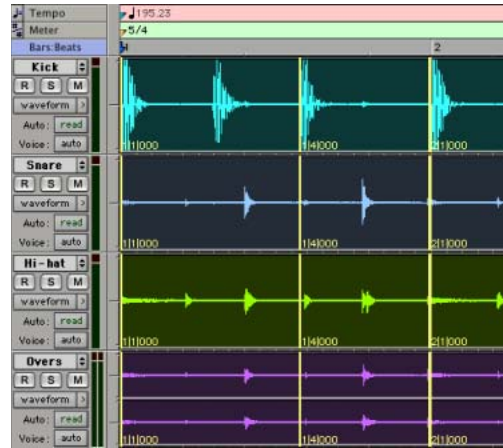

Figure 20. Kick drum, snare, hi-hat, and overhead microphones tracks

The separated regions can then be conformed as a group.

You can also utilize Collection mode when working with multiple tracks. Collection mode lets you analyze and detect triggers on tracks individually, and if you choose, add only the unique triggers from the current track to the overall collection. For more information, see “Detection (Normal) and Collection Mode” on page 349.

---

## Conforming Regions with Beat Detective

After regions have been separated with Beat Detective, the regions can then be conformed using one of two modes:

**Standard Conform** Uses the session's current tempo map (Grid)

**Groove Conform (Pro Tools 6.x only)** Uses groove templates.

Beat Detective will conform any selected region, whether or not it was separated with Beat Detective. However, in order to successfully conform regions with Beat Detective, the region start points must correspond to the start of the material that will align with the session's bars and beats. This should generally not be a problem if the regions were separated with Beat Detective (rather than manually separated or trimmed).

### Standard Conform

This is similar to using the Quantize Regions command, but with one important difference: With a single operation, Beat Detective can adjust the position of all regions, whether they have a straight or swing feel.



Beat Detective, Standard Conform options

### To conform regions using Standard Conform:

- 1 In the Beat Detective window, select Region Conform mode.
- 2 In Pro Tools 6.x, make sure Standard is selected.
- 3 In the Edit window, if not already selected, select the separated regions you want to conform. Make sure the selection's start and end points fall cleanly on the beat.
- 4 In the Beat Detective window, define or recapture the selection as described in "Defining a Beat Detective Selection" on page 336.
- 5 To affect how strongly the regions are conformed to the Grid (tempo map), select the Strength option and specify a percentage value with either the slider or by typing in a value:
  - Lower percentage values preserve the original feel of the regions.
  - Higher percentage values align the regions more tightly to the tempo map, with 100% aligning precisely to the tempo map.



*To "tighten up" the original feel, while retaining it, set the Strength option to 85–88%.*

- 6 To affect which regions are conformed, select the Exclude Within option and specify a percentage value with the slider or by typing in a value:
  - Lower percentage values ensure that regions further away from the Grid are conformed, while those closer to the Grid are not.
  - Higher percentage values ensure that regions closer to the Grid, as well as those further away, are conformed.



*To "tighten up" the original feel, while retaining it, set the Exclude Within option to 10–15%.*

**7** To achieve a swing feel for the conformed regions, select the Swing option and whether the swing is based on eighth-notes or sixteenth-notes, then specify a percentage value with the slider or by typing in a value:

- Smaller percentage values yield less swing, with 0% yielding none.
- Larger percentage values yield more swing, with 100% yielding a triplet, swing feel.
- Percentage values between 100–150 move the regions beyond a triplet, swing feel, toward the next sixteenth-note boundary (provided the Swing note value is set to eighth-notes).



*If Beat Detective has successfully captured enough of the sub-beats from a selection before separating, you can successfully conform with the Swing option to change the groove from a “straight” feel to one that is swung. You can also import a groove template containing a swing feel (see “Groove Conform” on page 347).*

**8** Click the Conform button to automatically conform all regions in the selection.

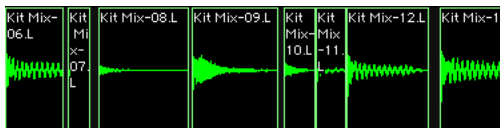

**Regions conformed with Beat Detective**

**9** Audition the new conformed regions by clicking Play in the Transport window.

**10** If necessary, select Edit > Undo, and repeat steps 4–8 trying a different set of Conform settings.

– or –

If necessary, apply Edit Smoothing (see “Edit Smoothing” on page 348).

## Groove Conform

### (Pro Tools 6.x Only)

Instead of using a grid based on the session’s tempo map, Groove Conform uses a grid based on a groove template, or DigiGroove. DigiGrooves can be used to apply the feel of a captured passage to the selected audio regions. For information about creating DigiGroove templates, see “DigiGroove Templates” on page 342.

#### To conform regions using Groove Conform:

- 1** In the Beat Detective window, select Region Conform mode.
- 2** Select Groove.



**Beat Detective, Groove Conform options**

**3** In the Edit window, if not already selected, select the separated regions you want to conform. Make sure the selection’s start and end points fall cleanly on the beat.

**4** In the Beat Detective window, define or recapture the selection as described in “Defining a Beat Detective Selection” on page 336.

**⚠** *When using Groove Conform, the captured selection must not include Bar|Beat Markers. Otherwise, the accuracy of the Groove Template will be compromised.*

**5** From the Groove Template pop-up menu, select the Groove Clipboard or a saved groove template (for information on creating groove templates, see “DigiGroove Templates” on page 342).

**6** To see comments about the selected template, click Show Info.

**7** To affect how strongly the regions are conformed to the groove template, select the Timing option and specify a percentage value with either the slider or by typing in a value:

- Lower percentage values preserve the original feel of the regions.
- Higher percentage values align the regions more tightly to the groove templates grid, with 100% aligning precisely to the template grid.
- If the slider is set to 200%, regions move to a location that is twice the difference between the original region location and the position of the referenced template event.

For example, if a note was played at Bar 1|1|060 (a 16th note), and the corresponding template event is at 1|1|073, a slider value of 100% results in the note being shifted to 1|1|073; a slider value of 200% shifts the note to 1|1|086.

**8** If desired, enable the Pre-Process using Standard Conform option. With this option enabled, Beat Detective conforms regions to the current Standard Conform settings before applying the groove template. With material in which the performance was not accurate, Pre-Process using Standard Conform can lead to better results by ensuring that the performance is accurately mapped to the correct bars, beats, and sub-beats before the groove template is applied. Experimentation is the best way to determine when it is appropriate to use this option.

 *When conforming an audio passage to a heavily swung groove template, enabling Pre-Process using Standard Conform will often yield better results.*

**9** Click the Conform button to automatically conform all regions in the selection.

**10** Audition the new conformed regions by clicking Play in the Transport window.

**11** If necessary, select Edit > Undo, and repeat steps 4–9 trying a different groove template or Groove Conform settings.

– or –

If necessary, apply Edit Smoothing (see “Edit Smoothing” on page 348).

---

## Edit Smoothing

After regions are conformed, there may be gaps between the regions. These gaps can cause the material to sound unnatural on playback.

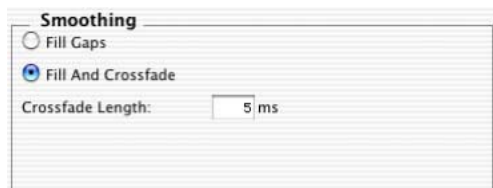

### Beat Detective, Smoothing options

Beat Detective can automatically fill the gaps between regions, and even add crossfades if you choose. This Edit Smoothing option can be used with regions that have been conformed, or with a track that contains many regions that need to be trimmed and crossfaded (such as in a sound effects track). This automated process of smoothing region edits can save many hours of tedious editing.

### To use Edit Smoothing on conformed regions:

**1** In the Beat Detective window, select Edit Smoothing mode.

**2** Select one of the following Smoothing options:

- Select Fill Gaps to trim region end points so that the gaps between regions are filled.
- Select Fill And Crossfade to trim region end points and automatically add a pre-fade (in ms) directly before each region start point.

**3** In the Edit window, if not already selected, select the range of conformed audio regions you want to smooth. Make sure the selection's start and end points fall cleanly on the beat.

**4** Click the Smooth button to smooth the edits for the selected regions.

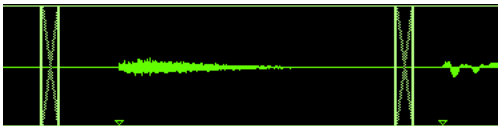
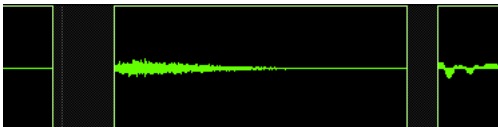

*Regions before and after Edit Smoothing*

**5** Audition the results by clicking Play in the Transport window.

**6** If necessary, select Edit > Undo, and repeat steps 2–5 trying a different Crossfade Length.

## Edit Smoothing Creates Sync Points

After smoothing edits with Beat Detective, sync points (corresponding to the material's start point) are automatically created for the conformed regions. This allows you to later conform the regions to a different tempo map or groove template, or use different Conform settings. However, sync points are only created as they are needed: If gaps between regions are created during Region Conform, Fill Gaps in Edit Smoothing mode will trim regions to fill the gap

and a sync point will be created at each region's original start point. If there is no gap between regions, no sync point will be created by Edit Smoothing.

 *For more information on region sync points, see "Defining Region Sync Points" on page 265.*

## Consolidating Regions after Edit Smoothing

The process of separating, conforming, and smoothing with Beat Detective can leave tracks with many regions and many crossfades. If you are working with multiple tracks, the density of these edits may lead to system performance problems.

Once you are satisfied with the results from Beat Detective, it is recommended that you flatten the tracks with the Consolidate Selection command. For all regions selected, Consolidate Selection creates a single, contiguous audio file to reduce the session's edit density. See "Consolidate Selection Command" on page 310.

 *Before consolidating a large selection across multiple tracks, make sure there is enough RAM available. See "RAM Requirements for Beat Detective" on page 334.*

---

## Detection (Normal) and Collection Mode

In some instances, it may be difficult for Beat Detective to successfully analyze multiple tracks with the same Detection settings. With Beat Detective's Collection mode, you can collect a set of beat triggers from different tracks, each with different Detection settings, and use the collection of triggers to generate Bar|Beat Markers or

DigiGroove templates, or separate new regions. Collection mode is the only way to analyze and create beat triggers on one track, and apply them to another track.

This method of selectively adding beat triggers from separate analysis passes on different tracks, until you get only the triggers you want, is potentially much more effective than manually deleting, inserting, or adjusting incorrect or false triggers.

## Drum Tracks and Collection Mode

Suppose you have drum tracks for kick, snare, hi-hat, and overhead mics. If you analyze a selection across all of the tracks, you may get many false triggers when you raise the Sensitivity slider high enough to capture the hi-hat material (coming mainly from the tracks for the overhead mics).

However, if you analyze only the track for the overhead mics, the resulting beat triggers are slightly later than the material on the other tracks (since it will take more time for the sound to reach the overhead mics). If you then extend the selection to the other drum tracks and separate them, the regions from the kick, snare, and tom tracks will be cut slightly late (see Figure 21 below).



Figure 21. Overhead mics generate late beat triggers

Using Collection mode, you can analyze each drum track separately, one at a time, optimizing the Detection settings for each track until you get the triggers you want. The triggers for each track can be added successively to the collec-

tion, or you can choose to collect only the unique triggers from a track. The collection of triggers that results can then be used to generate Bar|Beat Markers or a DigiGroove template, or separate new regions.

## Using Collection Mode

Collection mode is available in Bar|Beat Marker Generation, Groove Template Extraction, or Region Separation mode, and is accessed by clicking the Collection Mode button in the Detection section.

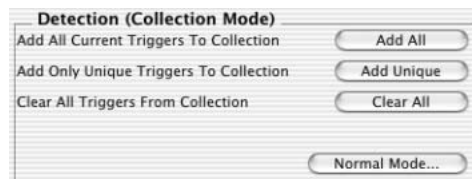

Beat Detective, Collection mode options

### To use Collection mode:

- 1 In the Edit window, make an audio selection on a single track. Make sure the selection's start and end points fall cleanly on the beat.
- 2 In the Beat Detective window, select one of the following modes:
  - Bar|Beat Marker Generation
  - Groove Template Extraction (Pro Tools 6.x only)
  - Region Separation

3 Define or capture the selection as described in “Defining a Beat Detective Selection” on page 336.

4 Configure the Detection options so the selection’s peak transients are accurately detected (see “Generating Beat Triggers” on page 338).

5 Click the Collection Mode button.

6 In the Detection (Collection Mode) section, click Add to add all the current beat triggers to the collection.

7 Click the Normal Mode button and move the selection to the next track you want to analyze. Make sure to keep the selection range constant for each track.

 Press **Start+P** (Windows) or **Control+P** (Macintosh) to move the selection up, or **Start+Semi-colon** (Windows) or **Control+Semi-colon** (Macintosh) to move the selection down.

*With Commands Focus enabled, press “P” to move the selection up, or Semi-colon (;) to move the selection down. Hold down the Shift key to retain and add to the current selection*

8 Configure the Detection options so the selection’s peak transients are accurately detected (see “Generating Beat Triggers” on page 338).

9 Click the Collection Mode button again.



Beat triggers detected in Kick track added to collection



Unique beat triggers detected in Snare track added to collection



Unique beat triggers detected in Hi-hat track added to collection



Collected beat triggers applied to Overhead microphones track

**Figure 22.** Overhead mic track displaying a collection of beat triggers containing unique triggers generated from the kick, snare, and hi-hat tracks

**10** In the Detection (Collection Mode) section, click Add Unique Triggers to add only the *unique* triggers from the track to the collection (Pro Tools 6.x only).

– or –

Click Add All to add *all* triggers to the collection.

– or –

Click Clear All to clear *all* triggers from the collection.

Each new set of triggers added to the collection appears in a different color. If successive triggers in the collection are located closely together (for example, because of microphone leakage), Beat Detective keeps only the earlier triggers (see Figure 22).

**11** Repeat steps 7–10 for each additional track you are analyzing.

The beat triggers stored in the Collection mode are saved with sessions. Therefore, when a session is opened later, the previous collection material is still there (until it is cleared).

**12** Once the desired beat triggers have been added to the collection, you can use them to generate Bar|Beat Markers or groove template, or separate regions. However, this must be done from the Collection Mode sub-pane (when the triggers are displayed in multiple colors).



*To separate regions across multiple tracks, make sure to extend the selection to any additional tracks before separating.*



# Part V: MIDI Editing



# Chapter 23: MIDI Editing

Pro Tools provides powerful MIDI editing tools. You can create and edit individual MIDI notes and controller events with the Pencil, Trimmer, and Grabber in the Edit window. You can also use the various MIDI Operations (such as Quantize, Transpose, Change Velocity, and Change Duration) to transform groups of MIDI notes to affect pitch, timing, and phrasing. For information on region-specific editing for both MIDI and audio, see Chapter 17, “Working with Regions and Selections.”

---

## The Pencil Tool

The Pencil tool is useful for creating and editing MIDI data. The Pencil tool shapes (Freehand, Line, Triangle, Square, and Random) can be used to enter pitches with varying durations and velocities (note velocities are determined by the Pencil shape). The various Pencil tool shapes can be particularly useful for drawing and editing different types of MIDI control data—for example, try using Line for volume, Triangle for pan, Freehand for pitch bend, and Square or Random for velocity.

### To select the Pencil tool shape:

- 1 Click the Pencil tool icon in the Tool Bar for the Pencil tool shape pop-up menu.

- 2 Select a Pencil tool shape.

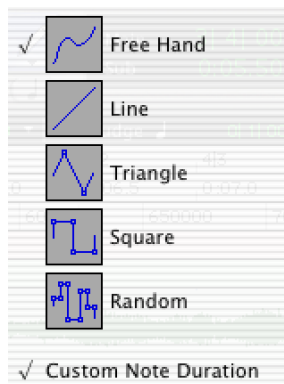

*Pencil tool shape pop-up menu*

### Freehand

When in Note view, the Freehand shape inserts a single MIDI note whose velocity is defined by the Default Note On Velocity MIDI preference (Setups > Preferences > MIDI). The pitch, location, and duration of the note are determined by where on the MIDI track you click and release with the mouse.

When editing MIDI velocities or continuous controller data, the Freehand shape draws freely according to the movement of the mouse. The shape is reproduced as a series of steps according to the Pencil Tool Resolution. When Drawing Controller Data MIDI preference (Setups > Preferences > MIDI).

## Line

When in Note view, the Line shape inserts a series of MIDI notes on a single pitch whose velocities are defined by the Default Note On Velocity MIDI preference (Setups > Preferences > MIDI). The duration of each note is determined by the current Grid value.

When editing MIDI velocities or continuous controller data, the Line shape draws in a straight line from click to release. MIDI continuous controller values change in steps according to the Pencil Tool Resolution When Drawing Controller Data MIDI preference (Setups > Preferences > MIDI).

## Triangle

When in Note view, the Triangle shape inserts a series of MIDI notes on a single pitch whose velocities oscillate between the defined Default Note On Velocity MIDI preference (Setups > Preferences > MIDI) and 127 according to a triangle pattern. The duration of each note is determined by the current Grid value.

When editing MIDI velocities or continuous controller data, the Triangle shape draws a triangular pattern that changes direction according to the current Grid value. MIDI controller values change in steps according to the Pencil Tool Resolution When Drawing Controller Data MIDI preference (Setups > Preferences > MIDI).

## Square

When in Note view, the Square shape inserts a series of MIDI notes on a single pitch whose velocities alternate between the defined Default Note On Velocity MIDI preference (Setups > Preferences > MIDI) and 127. The duration of each note is determined by the current Grid value.

When editing MIDI velocities or continuous controller data, the Square shape draws a square pattern that repeats at a rate based on the current Grid value.

## Random

When in Note view, the Random shape inserts a series of MIDI notes on a single pitch whose velocities change randomly within the range between the defined Default Note On Velocity MIDI preference (Setups > Preferences > MIDI) and 127. The duration of each note is determined by the current Grid value.

When editing MIDI velocities or continuous controller data, the Random shape draws a series of random values that change at a rate based on the current Grid value.

---

## Custom Note Duration

### (Pro Tools 6.x Only)

The Custom Note Duration command lets you define the default note duration for inserting notes manually.

#### To select a Custom Note Duration:

- 1 Click the Pencil tool icon in the Tool Bar for the Pencil tool shape pop-up menu.
- 2 Select Custom Note Duration. A note icon will appear below the Pencil tool icon in the Tool Bar.



*Pencil tool with note icon*

- 3 Click the note icon for the Custom Note Duration pop-up menu, and select a note duration.

The note icon changes to show the selected note value.

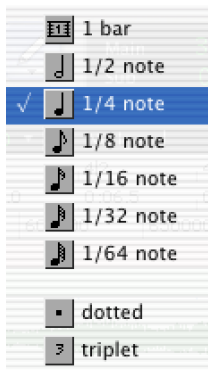

Custom Note Duration pop-up menu

---

## Setting the Grid Value

When inserting MIDI notes, the Grid Value determines the duration of each note, or other characteristics, based on the Pencil tool shape (see “The Pencil Tool” on page 355).

### To set the Grid value for MIDI editing:

- 1 Set the Main Time Scale to Bars:Beats (see “Setting the Main Time Scale” on page 234).
- 2 From the Grid Value selector, select a note value (such as 1/4, 1/8, or 1/16).
- 3 Verify the default session meter and tempo (see “Setting the Default Meter” on page 153 and “Setting the Default Tempo” on page 153).

 For more information on Grid mode, see “Grid” on page 225.

---

## Inserting MIDI Notes

In addition to recording and importing MIDI into Pro Tools, you can manually insert MIDI notes using the Pencil tool.

### To insert a MIDI note:

- 1 Set the MIDI track to Notes view.
- 2 Select the Pencil tool and make sure it is set to Freehand. The cursor will change to the Pencil when located over the playlist area of a MIDI track in Note view.



Pencil tool set to Freehand

- 3 To insert quarter notes on the beat, set the Time Scale to Bars:Beats, and set the Edit mode to Grid and the Grid value to quarter notes (0|1|000).
- 4 Move the Pencil into the playlist area for the MIDI track. Use the Edit window’s Ruler and the track’s mini-keyboard to locate the pitch and time location you want.

When using the Pencil, the Current Cursor display in the Options Bar provides information about its time location.



Current Cursor display

5 When you reach the pitch and time location you want, click to insert the note.

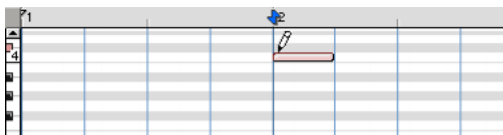

MIDI note inserted with the Pencil

💡 With the Smart tool active (see “The Smart Tool” on page 288), Start-click (Windows) or Control-click (Macintosh) to change the cursor to the Pencil tool and insert MIDI notes; Option-Control-click (Macintosh) or Alt-Start-click (Macintosh) to delete notes.

💡 In Pro Tools 6.x, with Grid mode enabled, the start point of the MIDI note snaps to the nearest Grid boundary by default. Control-click (Windows) or Command-click (Macintosh) with the Pencil to temporarily disable snap to grid.

The velocity for inserted notes is determined by the Default Note On Velocity MIDI preference (Setup > Preferences > MIDI). When in Grid mode, the duration of the note is determined by the Edit window’s Grid value. In Pro Tools 6.x, the duration of the note can also be determined by the Custom Note Duration value (see “Custom Note Duration” on page 356).

If the “Play MIDI Notes when Editing” preference is enabled (Setup > Preferences > MIDI), each inserted note will sound.

The Pencil can be dragged after clicking (and before releasing) to adjust the note’s pitch or duration. Click and drag right to lengthen the note without changing its start point. Click and drag left to shorten the note without changing its end point.

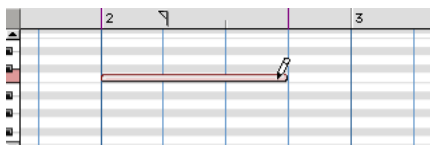

Adjusting the duration for an inserted note

💡 In Pro Tools 6.x, with Grid mode enabled, the end point of the MIDI note snaps to the nearest Grid boundary by default. Control-drag (Windows) or Command-drag (Macintosh) with the Pencil to temporarily disable snap to grid.

In Pro Tools 5.x, with Grid mode enabled, Control-drag (Windows) or Command-drag (Macintosh) with the Pencil to snap the note’s end point to the nearest Grid boundary.

The Pencil tool shapes (Line, Triangle, Square, and Random) can be used to enter a series of identical pitches with varying velocities. The length and spacing for the inserted notes are determined by the current Grid value, or by the Custom Note Duration value (Pro Tools 6.x only). The note velocities are determined by the Pencil shape.

Use the Square shape for alternating velocities of loud and soft. Use the Triangle shape for a ramp up and down of velocities. The Line shape enters notes with identical velocities.

### To insert a series of notes with random velocities:

- 1 Set the MIDI track to Notes view.
- 2 Select the Pencil tool and make sure it is set to Random.



*Pencil tool set to Random*

- 3 Set the Time Scale to Bars:Beats. In addition, set the Edit mode to Grid and the Grid value to quarter notes (0|1|000).

With these settings, the inserted notes will be spaced one quarter note apart.

- 4 Click at the point where the first note will be inserted and drag to the right until you have the number of notes you want.

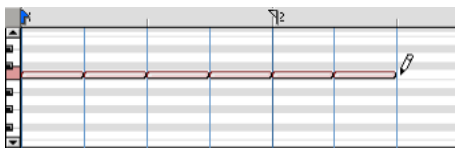

*Inserting a series of notes with the Pencil*

## Manually Editing MIDI Notes

All aspects of a MIDI note can be edited from the Edit window, including start and end points, duration, pitch, and velocity. The Grabber, Pencil, and Selector can operate on individual notes or groups of notes.

### Selecting MIDI Notes

MIDI notes must be selected, before they can be edited.

### To select MIDI notes:

- With the Grabber or Pencil, Shift-click each note.
  - or –
- With the Grabber, move the cursor to where there are no notes (the Marquee appears) and click and draw a rectangle around the group of notes.

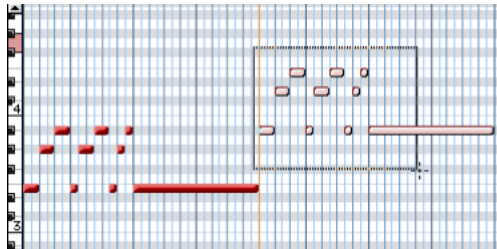

*Selecting notes with the Grabber*

When using the Grabber, if any portion of the rectangle touches a note (either its start or end point), the note is included in the selection. Selections made with the Grabber do not include underlying controller and automation data for the MIDI track.

- or –
- With the Selector, drag across a range of notes.



*Selecting notes with the Selector*

When using the Selector, a note's start point must be included in order for it to be selected. When a MIDI track is in Notes or Regions View, selections made with the Selector include underlying controller and automation data.

### To select a single pitch for the entire length of a track:

- On the mini-keyboard, regardless of the currently selected edit tool, Control-Shift-click (Windows) or Command-Shift-click (Macintosh) the note.

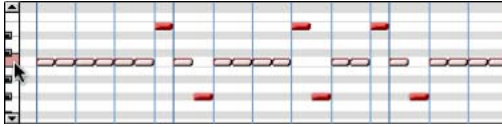

Selecting a pitch from the mini-keyboard

### To deselect one or more notes from a selection:

- With the Grabber or Pencil, Shift-click the notes so they become deselected.

## Transposing Notes

MIDI notes can be transposed by dragging up or down with the Grabber or Pencil. If several notes are selected before dragging, each is transposed.

### To transpose a MIDI note:

- 1 Set the MIDI track to Notes view.
- 2 Select the Grabber or Pencil.
- 3 While pressing Shift, drag the note up or down.

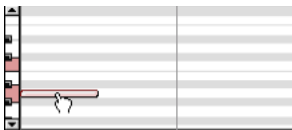

Transposing with the Grabber

The Shift key ensures that the transposed note retains its start point. While dragging, each new note sounds and the Current Cursor display indicates the number of semitones and direction (+/-) for the transpose.

 To transpose a copy of the note, leaving the original unchanged, press Control (Windows) or Option (Macintosh) while dragging.

## Moving Notes

Like regions, MIDI notes can be dragged left or right with the Grabber or Pencil to change their start point. If several notes are selected before dragging, each is moved.

### To move a MIDI note:

- 1 Set the MIDI track to Notes view.
- 2 With the Grabber or Pencil, drag the note left or right (press Shift while dragging to preserve the note's pitch).

As the note is dragged, the Current Cursor display indicates the new start point.

If the Edit mode is set to Grid, the dragged note snaps to the nearest Grid boundary. If the Edit mode is set to Spot, the Spot dialog opens.

 To copy the selected notes, leaving the originals intact, press Control (Windows) or Option (Macintosh) while dragging.

 The placement of MIDI notes can also be adjusted with Shift (see "Shift Command" on page 278) or Nudge (see "Nudging" on page 276).



## Trimming Note Start and End Times

Like regions, start and end points for MIDI notes can be adjusted with the Trimmer tool. If several notes are selected when performing the trim, each note is changed.

 *In Pro Tools 6.x, the Pencil tool can function like the Trimmer tool for changing the start and end points of MIDI notes.*

### To change the start or end points for a group of MIDI notes:

- 1 Set the MIDI track to Notes view.
- 2 Using the Grabber or Pencil, Shift-click each note you want to trim.
- 3 Select the Trimmer. For TDM systems, make sure the Standard Trimmer is selected in the Trimmer Tool pop-up menu.



**Trimmer tool set to Standard**

– or –

Use the Pencil tool (Pro Tools 6.x only).

- 4 Move the cursor near the beginning of any of the highlighted notes, so the Trim cursor appears. Drag right to shorten the notes, or drag left to lengthen them.

– or –

Move the cursor near the end of any of the highlighted notes, so the Trim cursor appears. Drag left to shorten the notes, drag right to lengthen them.

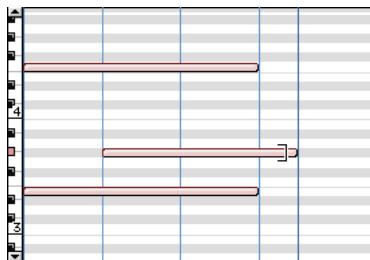

### Changing note end times with the Trimmer

If using Grid mode, the dragged start or end point snaps to the nearest Grid boundary. If using Spot mode, the Spot dialog opens, where you can enter the new location for the note's start or end point.

 *In Pro Tools 6.x, when in Grid mode, use the Control key (Windows) or the Command key (Macintosh) to temporarily disable Grid mode.*

Notes can also be trimmed with the Trim To Selection command (see “Trim To Selection Command” on page 263) and the Trim To Insertion command (see “Trim To Insertion Command” on page 270).

## Manually Editing Note Velocities

When a MIDI track is set to Velocity view, each note's attack velocity is represented with a velocity stalk. The taller the velocity stalk, the higher the velocity value (0–127).

### To edit MIDI velocity:

- 1 Set the MIDI track to Velocity view.
- 2 Select the Grabber tool.

**3** Drag the top (diamond) of the velocity stalk up or down.

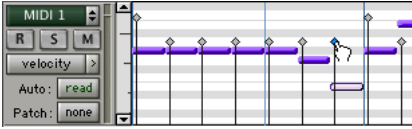

**Dragging a velocity stalk**

– Or –

If two notes have the same start time (with velocity stalks on top of each other), Control-drag (Windows) or Command-drag (Macintosh) the actual note up or down.

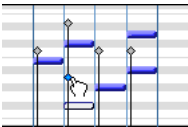

**Editing simultaneous velocities**

Drag up to increase the velocity value, or down to decrease it. While dragging, the diamond turns blue and the associated note becomes selected. The dragged velocity values are reflected in the Current Cursor display.

The velocities for a range of notes can be edited with the Pencil tool, either by Freehand or with any of the Pencil tool shapes.

**To draw velocity values that fade in:**

- 1 Set the MIDI track to Velocity view.
- 2 Select the Pencil tool with the shape set to Line.

**3** Click at the beginning of the note range, near the bottom of the velocity range, and drag to the right and up until the line encompasses the range of notes you want to include in the fade.

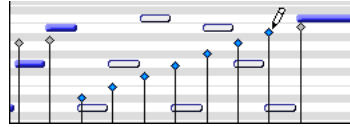

**Changing velocities with the Line shape**

You can also use the Trimmer tool to scale the velocities for all selected notes. This is useful if you like the velocity relationship between the notes, but want them to be louder or softer.

 *In Pro Tools 6.x, when in Velocity view, the Trimmer tool can be used to trim note durations in addition to changing velocities.*

**To scale velocities with the Trimmer:**

- 1 Set the MIDI track to Velocity view.
- 2 Using either the Selector or Grabber, select the range of notes to be edited.
- 3 With the Trimmer, click near the range of selected notes and drag up or down. Dragging up increases the velocities for each note; dragging down decreases them.

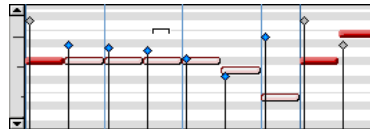

**Changing velocities with the Trimmer**

 *In Pro Tools 6.x, click in the upper 25% of the track height to scale velocities. When in Velocity view, clicking in the lower 75% of the track height lets you trim note lengths.*

## Typing in Note Attributes

When an individual note is selected with the Grabber or Pencil, its attributes are displayed in the Event Edit area.

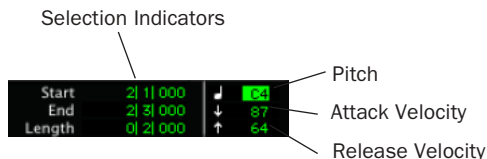

### Event Edit Area showing MIDI track information

Pitch is listed by note name and octave number. Attack and release velocities are listed with their MIDI values (0–127). Times for Start, End, and Length are displayed in the Main Time Scale.

### To change an attribute for a MIDI note:

- 1 In the MIDI track's playlist area, select the note with the Grabber or the Pencil.
- 2 Click in the Attributes text box and do one of the following:
  - Enter the new value on the numeric keypad.
  - Press the Up or Down Arrow to scroll to the new value.
  - In Pro Tools 6.x, drag up or down to scroll to the new value. In Pro Tools 5.x, press Control (Windows) or Command (Macintosh), then drag up or down to scroll to the new value.
  - Play the new note value on your MIDI controller keyboard.

Press the slash key (/) to move between the fields in the Event Edit area.

## Multiple Notes and Event Edit Area

When multiple notes are selected, you can enter values in the Event Edit area fields to affect all selected notes. A triangle (delta symbol) to the left of the displayed note indicates that multiple notes are selected.

A new value in the Start field moves the first note in the selection to that location, with all other notes moving with it.

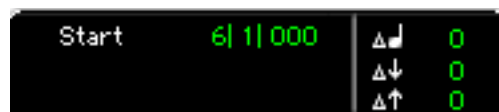

### Multiple notes in the Event Edit area

Values entered in the pitch and velocity fields add to or subtract from the values for all selected notes. For example, to transpose all selected notes down an octave, enter a value of –12 for pitch.

## Deleting MIDI Notes

In addition to deleting selected notes with the Clear command in the Edit menu, individual notes can also be deleted with the Pencil tool.

### To delete a group of MIDI notes with the Clear command:

- 1 Using the Grabber or Selector tool, select the notes to be deleted. For details, see “Selecting MIDI Notes” on page 359.

2 Choose Edit > Clear to delete the selected notes. The track's underlying controller data remains intact.

– or –

Press the Delete (Backspace) key.

**⚠** *When deleting MIDI notes within a time range selection, all underlying controller and automation data is also deleted.*

### To delete a single MIDI note with the Pencil:

■ With the Pencil tool selected, press Alt (Windows) or Option (Macintosh) so the tool changes to an Eraser, then click the note to delete it.

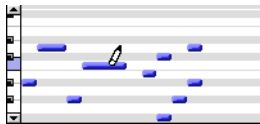

*Deleting a note with Pencil*

**💡** *Program change events and Sysex events can also be deleted by Alt-clicking (Windows) or Option-clicking (Macintosh) them with the Pencil tool.*

## Continuous Controller Events

Continuous controller events for MIDI tracks are displayed in the form of a line graph with a series of editable breakpoints. Controller events for MIDI tracks differ somewhat from automation data for audio tracks in that the breakpoints are stepped (instead of vector-based), where each breakpoint represents a single controller event.

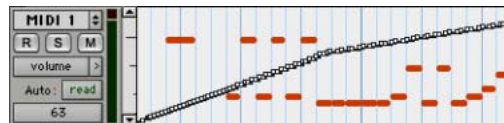

*MIDI track displaying volume events*

Continuous controller events that can be inserted and edited in Pro Tools include:

- volume
- pan
- pitch bend
- aftertouch (mono)
- MIDI controllers, 0–127

**⚠** *Polyphonic aftertouch cannot be viewed in the Edit window. To view polyphonic aftertouch in Pro Tools, use the MIDI Event List (see Chapter 25, “MIDI Event List”).*

MIDI controller #7 (volume) and #10 (pan) are treated by Pro Tools as automation data. This means that these controller events (along with Mutes) can be recorded and automated from the Mix window; in addition, each MIDI track's automation mode affects how these events are played back and recorded. While a MIDI track's volume and pan (and mute) events can be suspended, all other controller events in the track always play.

To avoid overwriting existing MIDI volume and pan automation data, record in MIDI Merge mode. In Pro Tools 6.x, when recording in MIDI Merge mode, existing volume and pan data will play back while recording new MIDI data. However, in Pro Tools 5.x, existing volume and pan data will not play back while recording new MIDI data.

Continuous controller events (including volume and pan) can be recorded from an external MIDI controller (such as a keyboard or control surface), and they can be inserted in a MIDI track's playlist using the Grabber or the Pencil.

## Inserting/Editing Controller Events

Continuous controller events can be edited with any of the following methods:

- ◆ Individual breakpoints can be dragged with the Grabber to adjust their location or value.
- ◆ A group of selected breakpoints can be scaled up or down with the Trimmer.
- ◆ New controller events can be drawn in with the Pencil tool to replace existing events. Events can be drawn with the Pencil set to Freehand, or using any of the shapes (Line, Triangle, Square, or Random).
- ◆ Controller events can be copied and pasted, nudged, and shifted.



*To copy continuous MIDI controller events and paste to a different MIDI controller, use Special Paste: Control+Start+V (Windows) or Command+Control+V (Macintosh). For example, you might want to use the same control data for volume and a cut-off filter, or for pan and pitch bend. For more information, see "Special Paste Function for Automation Data" on page 472.*

For details on these editing procedures, see Chapter 28, "Automation."

**▲** *Edits to volume data affect all tracks within an enabled Edit Group. This is not the case, however, for other controller playlists (such as pan). To insert and edit other controller types across all tracks in an Edit Group, press the Start key (Windows) or Control (Macintosh) while performing the edits.*

## Resolution for Inserted Controller Events

When inserting controller events with the Pencil, the density of the events is determined by the MIDI Preference for "Pencil Tool Resolution When Drawing Controller Data."

### To set the Pencil tool resolution:

- 1** Choose Setups > Preferences, then click the MIDI tab.
- 2** Enter a value for "Pencil Tool Resolution When Drawing Controller Data." The value range is from 1 to 100 milliseconds.
- 3** Click OK.

## Patch Select (Program and Bank Changes)

Each MIDI track can have a default program change that is sent each time the track plays. Additional program changes can be inserted at any point within the track.

### About Program and Bank Changes

The MIDI protocol lets you choose from a range of 128 programs (0–127). Most MIDI instruments have several banks of 128 programs. To specify which bank you're selecting from, a *bank select* message must be sent. Some instruments use Controller 0 to switch the bank while others use Controller 32; some use a combination of the two. The Patch Select dialog in Pro Tools allows you to use either of these bank select messages when inserting a program change event. Check the manufacturer's documentation for your MIDI device to see which Controller it uses.

 *Some older MIDI devices (such as the Kurzweil K1000) use a program change instead of a Bank Select message to switch banks. For these devices you may find it necessary to send two program change messages to access a particular program, where the first sets the bank and the second sets the program.*

### Default Program Change

The default program change for each MIDI track is specified by clicking on the Patch Select button, from either the Edit or Mix window. Once specified, the default program change message is sent to your instrument when playing the track.

To set the default program change for a MIDI track:

- 1 From the Edit or Mix window, click the Program button.



Program button, Edit window

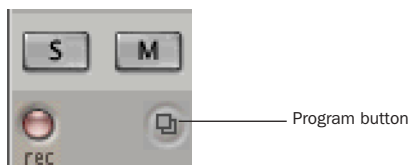

Program button, Mix window

- 2 Do one of the following:

- In the Patch Select dialog, select a program number.

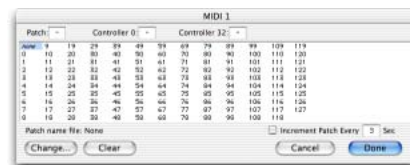

Patch Select dialog

- If you are using patch name files (Mac OS X only), choose a bank from the pop-up menu in the upper right of the Patch Select dialog and select a patch name. See “Patch Names” on page 367.

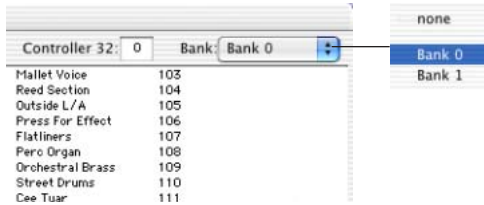

Choosing a bank in Patch Select dialog (Pro Tools 6.x)

- 3 Click Done.

Once selected, the program number (or patch name) appears in the Program button in the Edit window.



Program button, Edit window

Unlike recorded and inserted program change events, the default program change does not appear in the track’s playlist.

To clear the default program change, select None in the Patch Select dialog.

## Patch Names

### (Mac OS X Only)

Pro Tools supports XML (Extensible Markup Language) for storing and importing patch names for you external MIDI devices. Pro Tools installs MIDI patch name files (.midnam) for the factory default patch names of many common MIDI devices. These files reside in directories, sorted by manufacturer, in /Library/Audio/MIDI Patch Names/Digidesign/.

## To import MIDI patch names into Pro Tools:

- 1 Verify the MIDI Device name in Audio MIDI Setup (Setups > Edit MIDI Studio Setup).
- 2 Verify the MIDI track’s output is correctly assigned to the MIDI device.
- 3 Click the MIDI track’s Program button.
- 4 In the Patch Select dialog, click the Change button.
- 5 In the resulting Open dialog, navigate to /Library/Audio/MIDI Patch Names/Digidesign/<name of manufacturer>, and select the MIDI Patch Name file (.midnam) for the MIDI device.
- 6 Click Open.
- 7 The Patch Select dialog will be populated with patch names and the Patch Name Bank pop-up menu will appear in the upper left hand corner of the window.

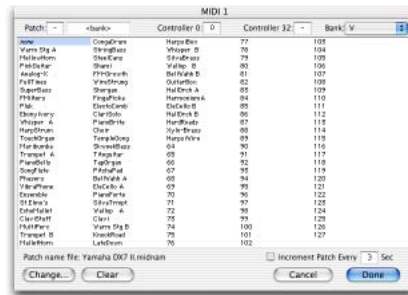

Patch Select dialog with patch names

Once patch names have been imported into Pro Tools, they will be available for that MIDI device in all sessions.

### To clear patch names:

- In the Patch Select dialog, click the Clear button.

 MIDI patch name files (.midnam) can be edited in any text editor (such as TextEdit), so you can create your own custom patch names.

## Inserting and Editing Program Changes

Program changes can be inserted into a track's playlist with the Pencil tool. Existing program changes can be edited, moved, and copied and pasted.

 On some instruments, changing programs during playback can interrupt playback. To avoid this, place program change events in the track where there are no notes sounding.

### To insert a program change with the Pencil:

- 1 Set the MIDI track to Program view.
- 2 If you want the inserted event to snap to a grid value, set the Edit mode to Grid.
- 3 Click with the Pencil in the track's playlist at the point where you want to insert the program change.
- 4 In the Patch Select dialog, select a program number (or name) and, if necessary, specify a bank change value.
- 5 Click Done to insert the program change event in the track's playlist.

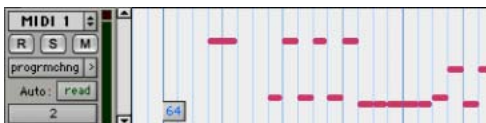

Program change event

### To edit a program change event:

- 1 With the Grabber or Pencil, double-click the program change event you want to edit.
- 2 In the Patch Select dialog, select the new program number (or name) and, if necessary, specify a bank change value.
- 3 Click Done.

### To move a program change event:

- With the Grabber or Pencil, drag the program change event left or right.

If the Edit mode is set to Grid, the dragged event snaps to the nearest Grid boundary. If the Edit mode is set to Spot, the Spot dialog opens.

 The placement of program changes can also be adjusted with Shift (see "Shift Command" on page 278) or Nudge (see "Nudging" on page 276).

### To delete a program change event:

- 1 With the track set to Notes view, click the program change event with the Grabber to select it.

– or –

If the region contains other events you want to delete, select the entire region with the Grabber (when the track is displaying regions).

- 2 Choose Edit > Clear to remove the selected events from the track.

– or –

Press the Delete (Backspace) key.

 Individual program change events can also be deleted by Alt-clicking (Windows) or Option-clicking (Macintosh) them with the Pencil.



## Auditioning Programs

When the Patch Select dialog is open, you can have Pro Tools automatically scroll through the different patches for a track's assigned MIDI device.

### To audition patches for a MIDI track during playback:

- 1 Click Play in the Transport window.
- 2 Open the Patch Select dialog by clicking the Program button in the Mix window, or by inserting or editing a program change event in a MIDI track.
- 3 Click a program number—the starting point from which you will scroll through the patches.
- 4 Enter a value for the number of seconds that will elapse between each program change.
- 5 Select the option for Increment Patch.

After the specified number of seconds, Pro Tools selects the next patch and transmits the program change to the track's assigned MIDI device.

### To audition patches from the Patch Select dialog:

- 1 Open the Patch Select dialog by clicking the Program button in the Mix window, or by inserting or editing a program change event in a MIDI track.
- 2 Click a program number—the starting point from which you will scroll through the patches.
- 3 Enter a value for the number of seconds that will elapse between each program change.
- 4 Select the option for Increment Patch.

After the specified number of seconds, Pro Tools selects the next patch and transmits the program change to the track's assigned MIDI device.

## System Exclusive Events

System Exclusive (Sysex) events can be recorded to MIDI tracks in Pro Tools (see “Recording System Exclusive Data” on page 188). Once the events are recorded, they appear in the track's playlist as blocks when the Display Format is set to Sysex.

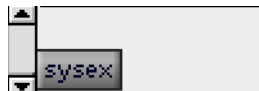

Sysex event block

While the contents of recorded System Exclusive events cannot be directly edited in Pro Tools, the events can be moved or nudged, copied and pasted, or deleted.

### To move a Sysex event:

- 1 Set the MIDI track to Sysex view.
- 2 With the Grabber, drag the Sysex event left or right.

If the Edit mode is set to Grid, the dragged event snaps to the nearest Grid boundary. If the Edit mode is set to Spot, the Spot dialog opens.

 *The placement of Sysex event blocks can also be adjusted with Shift (see “Shift Command” on page 278) or Nudge (see “Nudging” on page 276).*

### To delete one or more Sysex events:

1 With the track to Sysex view, click the Sysex event with the Grabber to select it.

– OR –

If the region contains other Sysex events you want to delete, select the entire region with the Grabber (when the track is displaying regions).

2 Choose Edit > Clear to remove the selected events from the track.

– OR –

Press the Delete (Backspace) key.

 *Individual Sysex event blocks can also be deleted by Alt-clicking (Windows) or Option-clicking (Macintosh) them with the Pencil.*

---

## Note and Controller Chasing

### Note Chasing

*Note Chasing* allows long, sustained MIDI notes to be heard when playing from a point after their start time. For example, if a note's start time is at 1|1|000 and lasts for 8 measures (until 9|1|000), note chasing lets you begin playing from bar 5 and still hear the note that started at 1|1|000 as it continues to sustain until 9|1|000.

Note Chasing is something that can be turned on and off individually for each MIDI track. By default, new MIDI tracks have Note Chasing enabled.

### To enable Note Chasing for a MIDI track:

■ Click the track's Playlist Selector and select the option for Note Chasing.

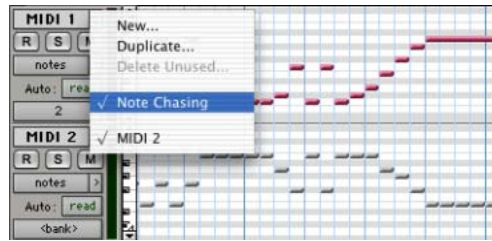

*Note Chasing enabled in Playlist Selector pop-up*

Make sure to disable Note Chasing when working with samplers that are playing loops. If a MIDI track, for example, is triggering a 4-bar drum loop and you begin playing at bar 3, the loop will begin playing at the wrong time and be out of sync with the other tracks.

### Controller and Program Chasing

Pro Tools always chases continuous controller events and program changes for MIDI tracks. This ensures that controller values and patches for MIDI devices are always appropriately set.

For example, suppose a MIDI track lasting 32 measures starts with a volume of 127 and in the last bar fades the volume down to 0. If after playing the track in its entirety you attempt to play from bar 8, the initial volume of 127 is chased and sent to the track's assigned device—otherwise the track would not be heard since the most recent volume event sent would have been 0.

Chasing also occurs for a MIDI track's default program change, along with any program change events residing within the track. Therefore, if you have chosen a default program change for a track, when playing from any point within the track, the program change event is sent to the track's assigned device.

## Default Controller Values and Chasing

Though new MIDI tracks appear to have default values for continuous controller playlists, this is actually not the case. For example, when viewing a MIDI track's Mod Wheel playlist, you'll see that the breakpoint line is set to a default of zero. However, since the modulation wheel on your synth may purposely be set to a different value, the default value in the track is not transmitted when playing.

This can cause some confusion, however, if you insert a fade (for example, from 0–90) in the Mod Wheel playlist towards the end of the track. If you then play from the beginning of the track, or from anywhere before the fade, the Mod Wheel value on your synth will be at 90 until the beginning of the fade data is reached—which is likely not what you want.

To ensure that the default controller value for a playlist is sent (and chased), click the initial breakpoint at the beginning of the track, move it slightly, and set it back to the default value.

---

## Offsetting MIDI Tracks

Pro Tools can offset MIDI tracks globally or individually.

### Global MIDI Playback Offset

Pro Tools offers a MIDI offset preference that allows MIDI tracks to play back earlier or later (than audio tracks) by a specified number of samples. The offset affects playback only and does not alter in any way how MIDI data is displayed in the Edit window.

This capability is provided in large part to compensate for the audio monitoring latency in Pro Tools LE. If you are monitoring the output of your MIDI devices with an external mixer or

sound system (or headphones), there is no latency. If, however, you are monitoring the output of your MIDI devices through a Digi 002, Digi 002 Rack, Digi 001, or Mbox, your MIDI tracks will appear to play slightly later than your audio tracks. The larger the setting for the H/W Buffer Size (128, 256, 512, or 1024 samples), the larger the latency.

By configuring the Global MIDI Playback Offset, you can get your MIDI tracks to play back slightly earlier (by a specified number of samples), thereby compensating for the latency in monitoring audio within Pro Tools LE.

### To configure the Global MIDI Playback Offset:

- 1 Choose Setups > Preferences and click MIDI.
- 2 For the “Global MIDI Playback Offset” option, enter the number of samples (–10,000 to 10,000) for the offset. A negative value causes the MIDI tracks to play back earlier than the audio tracks; a positive value causes the MIDI tracks to play back later.

To allow for monitoring latency in Pro Tools LE, set the offset to a value that is roughly equivalent to the H/W Buffer Size.

- 3 Click Done.



*The Global MIDI Playback Offset can also be set from the MIDI Track Offsets window.*

### Individual MIDI Track Offsets

You can offset individual MIDI track offsets in Pro Tools to compensate for delays in MIDI devices (the time it takes to trigger events on a sampler or synth).

For example, if you have some kick drums that are being played by an audio track in Pro Tools and want them to be perfectly “in sync” with kick drums that are being played by a MIDI de-

vice, you may need to use a MIDI offset. In this example, it will usually take at least 5 ms to trigger the MIDI notes, and it could take even longer, depending on the MIDI device.

You can measure the latency for a MIDI device assigned to a MIDI track by recording its audio output back into Pro Tools. Compare the sample locations for the recorded audio events against the original MIDI notes to calculate the latency.

### To configure a MIDI track offset for a track:

- 1 Choose Windows > Show MIDI Track Offsets.

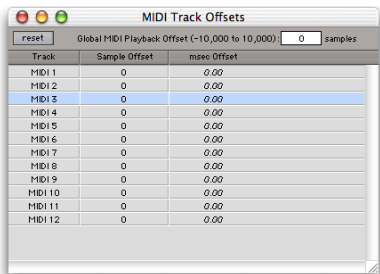

#### MIDI Track Offsets

- 2 Click in the Sample Offset column for the MIDI track and enter the number of samples (-10,000 to 10,000) for the offset. A negative value causes the MIDI tracks to play back earlier than the audio tracks; a positive value causes the MIDI tracks to play back later.

The equivalent offset in milliseconds is displayed in the Msec Offset column. This value cannot be edited, but updates when a new value is entered in the SMPTE Offset column.

- 3 Press Enter (Windows) or Return (Macintosh) to accept the entered offset value.

To reset all offsets for all MIDI tracks, click the Reset button in the upper left of the window.

---

## Stuck Notes

If you encounter stuck notes with any of your MIDI devices, you can silence them with the All Notes Off command.

### To turn off all stuck notes:

- Choose MIDI > All Notes Off.



*Press Control+Shift+Period (Windows) or Command+Shift+Period (Macintosh) for the All Notes Off command.*

# Chapter 24: MIDI Operations

## MIDI Operations Window

The MIDI Operations window opens when choosing any of the following commands from the MIDI menu:

- Quantize
- Groove Quantize
- Restore Performance
- Flatten Performance
- Change Velocity
- Change Duration
- Transpose
- Select Notes
- Split Notes
- Input Quantize

To reconfigure the MIDI Operations window for a different command, select the command from the MIDI menu or from the pop-up menu at the top of the window.

The MIDI Operations window can be left open, revisiting it as necessary to apply a command, or to try out different options for a particular command.

### To show or hide the MIDI Operations window:

- Choose Windows > Show MIDI Operations.

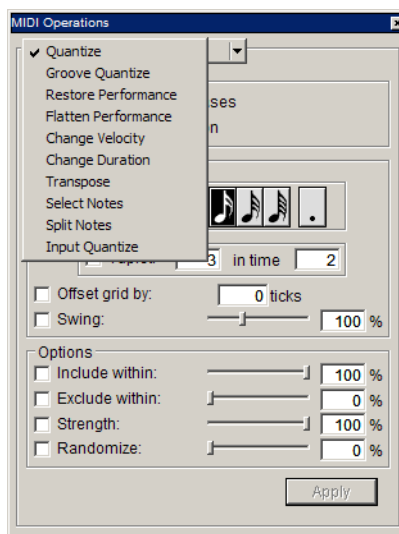

Figure 23. MIDI Operations window

### To apply the command in the MIDI Operations window:

- Click Apply or press Enter on the numeric keypad. This applies the command and leaves the window in the foreground.

– or –

- Press Enter on the alpha keyboard (Windows) or Return (Macintosh). This applies the command and closes the window.

### To undo the command in the MIDI Operations window:

- Choose Edit > Undo.

## Using the MIDI Operations Window

Use the following methods to easily configure the various options, which vary from command to command, in the MIDI Operations window:

- ◆ To move forward and back through the various fields, press Tab or Shift+Tab.
- ◆ Increment or decrement selected fields with the Up and Down Arrows. Press and hold these keys to scroll quickly through the values.
- ◆ Control-drag (Windows) or Command-drag (Macintosh) up or down in a selected field to scroll to a new value.
- ◆ Press Control (Windows) or Command (Macintosh) while adjusting sliders for finer resolution.
- ◆ For selected pitch and velocity fields, play a note on your MIDI controller keyboard to automatically enter it.
- ◆ Changing a value for a particular control (such as the Swing Percentage in the Quantize window), automatically enables the control.

---

## Select Notes

The Select Notes command allows you to further narrow a selection of MIDI notes based on pitch. The command can be used to select a single note or note range for the entire length of a region or track, or to select the upper or lower voices within chords.

### To open the Select Notes window:

- Choose MIDI > Select Notes.

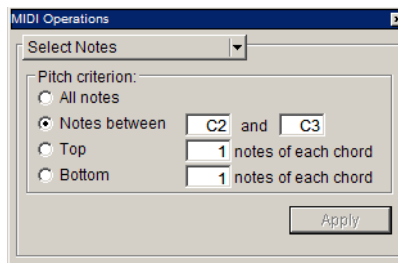

Select Notes window

Options for the Select Notes command include:

**All Notes** Selects all notes.

**Notes Between** Selects a range of notes between the specified upper and lower note. Values for the notes can be entered in pitch (C1–G8) or MIDI note numbers (0–127).

**Top** Selects the highest note or notes in each chord.

**Bottom** Selects the lowest note or notes in each chord.

### Selecting a Pitch Range of Notes

A common use for Select Notes is to select a single note for the entire length of a region or track. This is especially useful if you want to select a note in a MIDI drum track (such as a hi-hat), and affect it over the selected time range with the Quantize, Groove Quantize, Transpose, or Change Duration command.

### To select only the hi-hats in a General MIDI drum track:

- 1 Using the Grabber or Selector, select the range of MIDI notes that contains the note.
- 2 Choose MIDI > Select Notes.

3 Select the Notes Between option with the note range set to F#1 and F#1 (if the MIDI Note Display preference is set to Standard Pitch).

For a General MIDI drum kit, the closed hi-hat is assigned to MIDI note number 42 (F#1 at Standard Pitch). If the hi-hat for your drum kit is assigned to a different note, make sure to specify it.

4 Click Apply.

## Selecting Notes in a Chord

Another use for Select Notes is to select only the upper or lower notes in a chord. Many times you'll want to affect only the upper or lower notes in a chord—to boost their velocities, or transpose their pitch.

### To select only the bass notes in a chord:

1 Using the Grabber or Selector, select the range of MIDI notes that contains the notes.

– or –

To affect all the MIDI notes on a track, click in the track with the Selector, so that it contains a blinking Edit cursor.

2 Choose MIDI > Select Notes.

3 Select the Bottom option and leave the number of notes set to 1.

4 Click Apply.

 *In order for notes to be considered a chord, their start times must be within five ticks of each other.*

## Split Notes

The Split Notes command has the same selection criteria as the Select Notes command, but also lets you automatically cut or copy the selected notes when clicking Apply.

### To open the Split Notes window:

■ Choose MIDI > Split Notes.

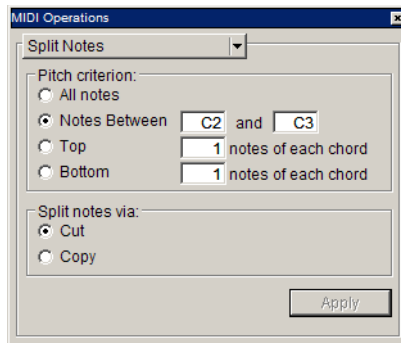

*Split Notes window*

One use for this command would be if you recorded a track with chords in the left hand and melody in the right. With the Split Notes command, you could cut the melody notes and paste them to another track so you could assign them to play on a different device or channel. Another use is split the various notes of a drum track (such as kick, snare, and toms) from a single drum track to create separate tracks for each instrument.

### To cut a specific pitch range of notes:

1 Using the Grabber or Selector, select the range of MIDI notes that contains the notes.

– or –

To affect all the MIDI notes on a track, click in the track with the Selector, so that it contains a blinking Edit cursor.

2 Choose MIDI > Split Notes.

3 In the Split Notes dialog, select the option for Notes Between and enter the low and high notes for the pitch range.

When either of the Pitch fields are selected, you can play a pitch on your MIDI controller to automatically enter it.

4 Select Cut.

5 Click Apply. Notes falling within the specified pitch range are removed from the selection and placed on the Clipboard. The notes can then be pasted or merged to another track.

---

## Change Velocity

The Change Velocity command automatically adjusts attack and release velocities for selected MIDI notes. Use it to make notes louder or softer, or to create crescendos or decrescendos.

Velocities can also be edited manually with the Pencil and Grabber Tools (see “Manually Editing MIDI Notes” on page 359).

 *Velocity values usually affect the loudness of MIDI notes. They may also affect other aspects of an instrument's sound, such as filter cutoff, envelopes, and modulations.*

 *The settings in the Change Velocity window are saved with each session. To store your favorite settings as the default for use in future sessions, save them as part of a session template (see “Creating Custom Session Templates” on page 51).*

### To open the Change Velocity window:

- Choose MIDI > Change Velocity.

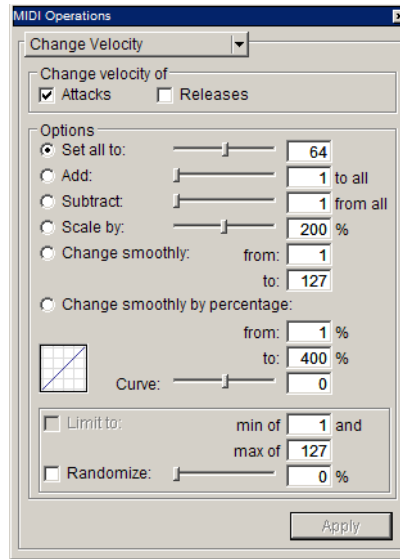

### Change Velocity window

 *While there are options for adjusting both the attack and release velocities for notes, most MIDI devices ignore release velocity information. To see if your instrument supports release velocities, refer to the manufacturer's documentation.*

**Set All To** Sets all velocities to the specified value (1–127).

**Add** Adds to existing velocity values by the specified amount (1–127).

**Subtract** Subtracts from existing velocity values by the specified amount (1–127).

**Scale By** Scales all velocities by a percentage amount (1–400%).

**Change Smoothly** Allows velocities to change smoothly from one value to another over time.



**Change Smoothly by Percentage** Allows velocities to change smoothly from one percentage value to another over time.

The curve for this change can be adjusted (+/- 99) to affect how gradually the change occurs.

**Limit To** When selected, restricts the Change Velocity command to a minimum and maximum range.

**Randomize** When selected, the Change Velocity command is randomized by the specified percentage value. For example, using “Set all to” with a value of 64, along with a Randomize value of 50%, yields velocities anywhere between 48 and 80 (+/- 25% of the velocity value).

## Velocity Ranges

The valid range for MIDI note velocities is 1–127. The Change Velocity command will never result in moving velocities outside this range; 1 will always be the lowest and 127 will always be the highest. This means that you may reach a state where the Change Velocity command has no effect on a particular note.

For example, if a note with a velocity 64 is scaled by 200%, the new velocity would be 127. Attempting to scale or increase the velocity any further would yield no change.

## Fading Velocities

**To change velocities smoothly over time:**

- 1 Select the range of MIDI notes to be edited.
- 2 Choose MIDI > Change Velocity.
- 3 Select the Change Smoothly option with the range set from 127 to 0.
- 4 Click Apply.

To preserve (somewhat) the existing velocity relationships and still achieve velocity fades, use the option for Change Smoothly by Percentage. Figure 24 illustrates the difference between the two Change Smoothly options.

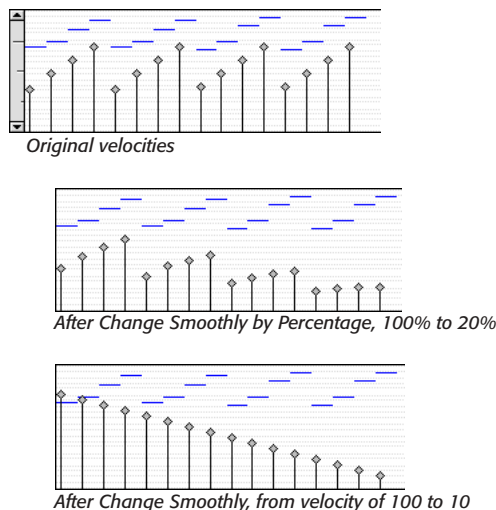

Figure 24. Change Smoothly by Percentage

## Scaling Velocities

Many times existing note velocities will have the relationship you want, but will either be too soft or too loud overall. In these instances, use the Scale By option.

**For example, to make velocities 20% louder:**

- 1 Select the range of MIDI notes to be edited.
- 2 Choose MIDI > Change Velocity.
- 3 Select the Scale By option with the percentage value set to 120.
- 4 Click Apply.

---

## Change Duration

The Change Duration command adjusts durations for selected MIDI notes. Use it to make melodies and phrases more staccato or legato.

 *The settings in the Change Duration window are saved with each session. To store your favorite settings as the default for use in future sessions, save them as part of a session template (see “Creating Custom Session Templates” on page 51).*

### To open the Change Duration window:

- Choose MIDI > Change Duration.

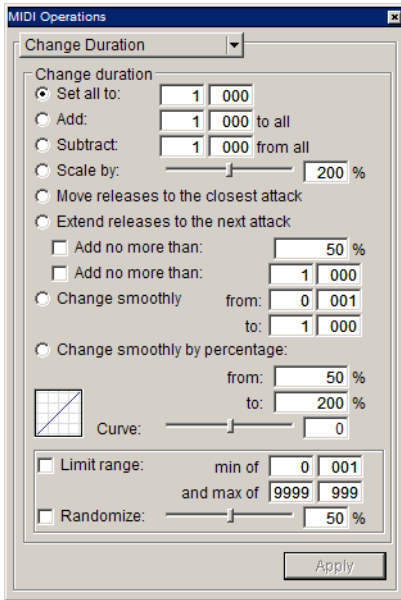

Change Duration window

**Set All To** Sets all durations to a length specified in quarter notes and ticks.

**Add** Adds to the durations by a specified number of quarter notes and ticks.

**Subtract** Subtracts from the durations by a specified number of quarter notes and ticks.

**Scale by** Shortens or lengthens durations based on a percentage value (1–400%).

**Move Releases to the Closest Attack** Shortens or lengthens durations so that end times are moved to the closest attack.

**Extend Releases to the Next Attack** Lengthens durations so that end times are extended to the next attack. To limit the duration change, select either of the Add No More Than options, using either a percentage value or a number of quarter note and ticks.

**Change Smoothly** Allows note lengths to change smoothly from one duration to another over time. Duration values are specified in quarter notes and ticks.

**Change Smoothly by Percentage** Allows note lengths to change smoothly from one percentage value to another over time.

The curve for this change can be adjusted (+/– 99) to affect how gradually the change occurs.

**Limit Range** When selected, restricts the Change Duration command to a minimum and maximum range (in quarter notes and ticks).

**Randomize** When selected, the Change Duration command is randomized by the specified percentage value. For example, using “Set all to” with a value of 480 ticks, along with a Randomize value of 50%, yields durations anywhere between 360 and 600 (+/– 25% of the duration value).

## Change Duration Examples

### To make notes more staccato:

- 1 Select the range of MIDI notes to be edited.
- 2 Choose MIDI > Change Duration.

3 Select the option for Scale By with a percentage value of 50.

4 Click Apply. The durations for the selected notes are reduced by 50%.

With this option you may have to experiment with the percentage value to achieve the desired effect.

**To make notes more legato:**

1 Select the range of MIDI notes to be edited.

2 Choose MIDI > Change Duration.

3 Select the “Extend Release to the Next Attack” option.

4 Click Apply. The end points for the selected notes are extended to the start point of the next note, thereby eliminating the space between each note.

To vary this effect, making it more or less legato, select the Add No More Than percentage option. Percentage values larger than 100 extend note end times so that the notes essentially overlap.

---

## Transpose

While the Grabber Tool can be used to manually transpose individual MIDI notes, or small groups of notes, the Transpose command can be used for entire MIDI tracks and regions.

**To open the Transpose window:**

- Choose MIDI > Transpose.

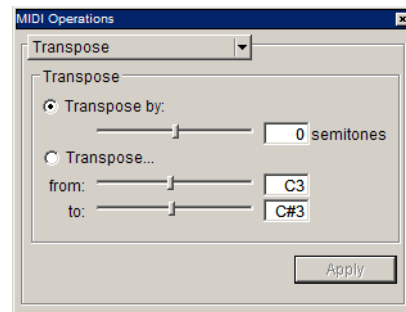

**Transpose window**

The two options for the Transpose command are:

**Transpose By (Semitones)** Transposes chromatically, up or down, by up to 60 semitones. To transpose down by an octave, for example, use -12 semitones.

**Transpose (From and To)** Transposes by semitones, as expressed by the difference between the source and destination pitches. Transposing from C3 to F#3, for example, transposes the notes up by an augmented fourth (six semitones).

One of the more common uses for Transpose is to change the key for your MIDI tracks. You can define an Edit Group for MIDI tracks that you want to transpose, making sure to exclude any drum tracks from the group so they aren't transposed.

**To transpose MIDI notes to another key:**

- 1 If you will be transposing a group of tracks, make sure to enable the Edit Group.
- 2 With the Selector or Grabber, select the range of MIDI notes to be transposed.
- 3 Choose MIDI > Transpose.
- 4 Select the option for Transpose (From, To).
- 5 Set the "From" and "To" values, for example, to C4 and E4 to transpose from C to E.

With either of the pitch fields selected, you can play a note on your MIDI controller to automatically enter it as the pitch value.

- 6 Click Apply.

It is also common to transpose MIDI tracks up or down by an octave.

**To transpose a MIDI track up by an octave:**

- 1 With the Selector, double-click in the track to select all of its notes.
- 2 Choose MIDI > Transpose.
- 3 Select the Transpose By option.
- 4 Enter a value of 12 semitones and then click Apply.

---

## Quantize

The Quantize command adjusts MIDI note locations and durations so that timing is improved, or so that a particular rhythmic "feel" is achieved. Quantize works by aligning notes to a Quantize Grid, the size of which is defined in the Quantize window by a standard note duration.

The Quantize command is not the same as the Quantize Regions command (in the Edit menu). The Quantize Regions command adjusts the start point for a selected region, and its contents are moved along with the region (with rhythmic relationships remaining intact).

The Quantize command, on the other hand, affects MIDI notes individually. Some notes may be moved back in time, others forward; and, some notes will be more drastically affected than others.



*The settings in the Quantize window are saved with each session. To store your favorite settings as the default for use in future sessions, save them as part of a session template (see "Creating Custom Session Templates" on page 51).*

## To open the Quantize window:

- Choose MIDI > Quantize.

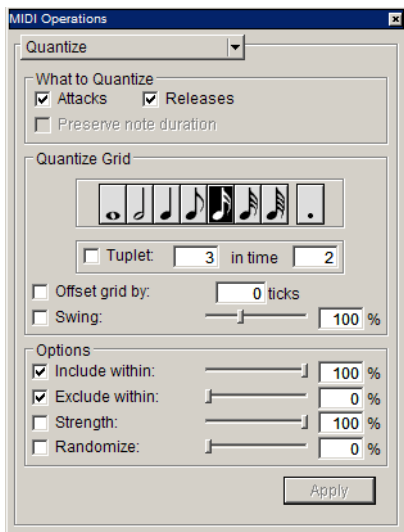

Quantize window

## What to Quantize

The options under “What to Quantize” determine which aspects of the notes are quantized: attacks, releases, or both.

**Attacks** When selected, note start points are quantized.

**Releases** When selected, note end points are quantized.

**Preserve Note Duration** When selected, note durations are preserved.

When deselected with the Attacks option selected, note end points are not moved.

When deselected with the Releases option selected, note start points are not moved.

If the options for both Attacks and Releases are selected, the Don't Change Durations option is ignored (and dimmed).

Figure 25 shows how notes are adjusted by the different What To Quantize options.

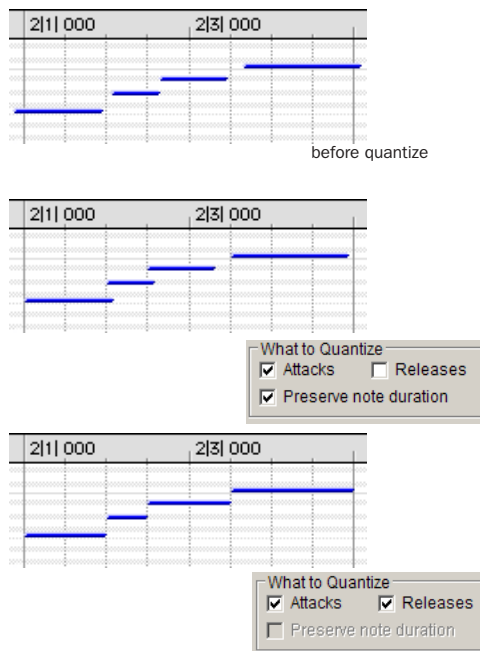



Figure 25. What To Quantize examples

## Quantize Grid

The Quantize Grid determines the beat boundaries to which notes are aligned. Any size from whole notes to thirty-second notes (including dotted values) can be selected for the Grid size.

 *Relative Grid mode does not affect the Quantize Grid.*

**Tuplet** Select the Tuplet option to quantize irregular note groupings like triplets or quintuplets. The Quantize Grid for triplets is calculated from the note size selection and the Tuplet value. For example, if an eighth note equals 480 ticks, triplet eighth notes with 3 in time of 2 would yield a Grid size of 320 ticks ( $480 \text{ ticks} / 3 * 2$ ).

**Offset Grid By** Offsets the Quantize Grid forward or back in time by a specified number of ticks. Use this option to achieve a pushed feel (by using positive values) or a laid back feel (by using negative values).

 To Quantize just the backbeats, set the Quantize Grid to half-notes with an Offset of 960 ticks.

**Swing** When selected, every other Grid boundary is shifted by the specified percentage value (0–300) to achieve a “swing” feel. A Swing value of 0% yields no swing, while 100% yields a triplet feel. With Swing set to 300%, every other Grid boundary is moved to the next Grid point.

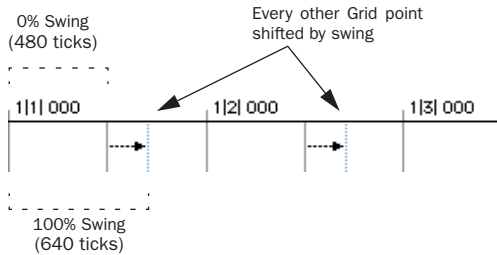

100% Swing, eighth note Grid

## Options

Additional Quantize options include:

**Include Within** When selected, attacks and releases are only quantized if located within the specified percentage of the Quantize Grid. Use this option to clean up downbeats without affecting notes that are “swung” or wildly off the beat.

Figure 26 shows the Quantize Grid set to quarter notes with the Include Within option set to 50%. Only attacks and releases falling within the shaded area (equivalent to an eighth note area around each beat) are quantized.

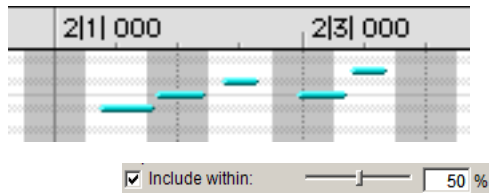

Figure 26. Include Within option

**Exclude Within** When selected, attacks and releases are not quantized if located within the specified percentage of the Quantize Grid. Use this option to preserve the feel of notes close to the beat, while correcting others that are drastically away from the beat.

Figure 27 shows the Quantize Grid set to quarter notes with the Exclude Within option set to 25%. Attacks and releases falling within the shaded area (equivalent to a sixteenth note area around each beat) are not quantized.



Figure 27. Exclude Within option

**Strength** When selected, notes are moved a percentage toward the Quantize Grid. Lower percentages preserve the original feel of the notes, higher percentages align the notes more tightly to the Grid.

**Randomize** When selected, notes are moved randomly forward or back in time (after the Quantize occurs). For example, with the Quantize Grid set to eighth notes and Randomize set to 50%, notes are placed up to a 32nd note before or after the beat boundary. The Randomize setting also affects note durations (if Releases is selected).

## Quantize Examples

The following examples illustrate some of the more common uses for the Quantize command.

If you intend to loop playback while quantizing, you may want to deselect Operations > Link Edit and Timeline Selection. This ensures that the play range will not change when selected notes are moved in the course of quantizing and undoing.

**▲** *In Pro Tools 6.x, you can use Restore Performance to revert to the original version (See “Restore Performance” on page 390.)*

*With Pro Tools 5.x, you must duplicate the playlist before quantizing.*

### Straight Quantize

#### To quantize to a straight sixteenth note feel:

- 1 Select the range of MIDI notes to be quantized.
- 2 Choose MIDI > Quantize.
- 3 Under What to Quantize, select the Attacks option. To quantize note durations as well, select the Releases option.
- 4 Set the Quantize Grid to sixteenth notes. Make sure that the other options for Tuplet, Offset Grid By, and Swing are not selected.
- 5 Leave the remaining Quantize options deselected and click Apply.

### Quantizing While Preserving the Original “Feel”

You can quantize less strictly, to preserve the original feel of your recorded MIDI tracks.

#### To quantize while preserving the original feel:

- 1 Select the range of MIDI notes to be quantized.
- 2 Choose MIDI > Quantize.
- 3 Under What to Quantize, select the Attacks option. To quantize note durations as well, select the Releases option.
- 4 Set the Quantize Grid to the note value you want to use. Make sure that the other options for Tuplet, Offset Grid By, and Swing are not selected.
- 5 Select the Exclude Within option with a value of 10–15%.
- 6 Select the Strength option with a value of 70–80%.
- 7 Leave the remaining Quantize options deselected and click Apply.

Audition the change and if the desired effect is not achieved, undo the edit and experiment with different values for Exclude Within and Strength.

## Quantizing with Swing

If you're working with hi-hats or bass lines, you may want to apply more of a swing feel to the track.

### To quantize with an eighth note swing feel:

- 1 Select the range of MIDI notes to be quantized.
- 2 Choose MIDI > Quantize.
- 3 Under What to Quantize, select the Attacks option. To quantize note durations as well, select the Releases option.
- 4 Set the Quantize Grid to eighth notes.
- 5 Select the Swing option with the Swing percentage you want:
  - For a light swing, use 12%.
  - For a tighter swing-like groove, use 24%.
  - For a true “triplet-like” swing feel, use 50–75%.
- 6 Make sure the options for Tuplet, Offset Grid By, and Randomize are not selected. Click Apply.

Audition the change and if the desired effect is not achieved, undo the edit and experiment with a different Swing percentage.

## Quantizing with Randomize

If quantized notes sound too mechanical or “on the beat,” use the Randomize option in the Quantize window to make them sound more natural.

### To “humanize” the rhythmic feel of notes:

- 1 Select the range of MIDI notes to be quantized.
- 2 Choose MIDI > Quantize.
- 3 Under What to Quantize, select the Attacks option. To quantize note durations as well, select the Releases option.
- 4 Set the Quantize Grid to the note value you want to use.
- 5 Select the Randomize option with a value of 5%.
- 6 Click Apply.

Audition the change and if the desired effect is not achieved, undo the edit and experiment with a different Randomize percentage.

## Experimenting with Quantize

When using the Quantize command, you'll often have to experiment with many of the controls. You may have to try different values for Include and Exclude Within, and Strength; these controls determine which notes are affected and how drastically they are changed. In addition, the Randomize control, which adds a percentage of randomness to the quantize, can be used to make tracks feel less mechanical—less perfect.

Although quantize is a wonderful tool for cleaning up tracks and playing with the feel of your music, sometimes the recorded data may not be salvageable. In these instances it is wise not to spend too much time trying to fix something that should probably just be re-recorded.



## Input Quantize

When Input Quantize is enabled, all recorded MIDI notes are quantized automatically. To preserve the original “feel” of your recorded MIDI tracks, make sure to disable this option.

### To enable Input Quantize:

- 1 Choose MIDI > Input Quantize.
- 2 In the Input Quantize window, select the Enable Input Quantize option.

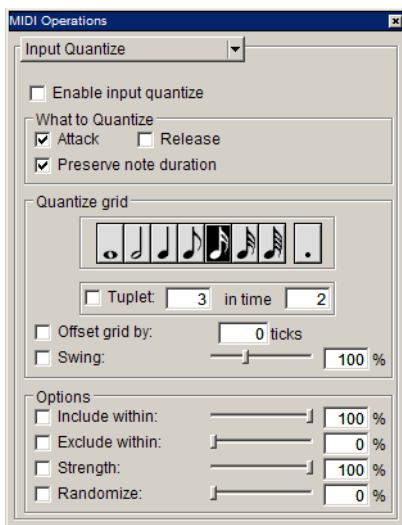

*Input Quantize window*

Configure the other options in the Input Quantize window. For details on the various Quantize options, see “Quantize” on page 380. When finished, close the Input Quantize window.

For *drum machine* style loop recording, use Input Quantize while loop recording MIDI in Merge mode (see “Loop Recording with Merge Mode” on page 185).

## Groove Quantize

The Groove Quantize command adjusts MIDI note locations and durations according to a *groove template* rather than a strict quantization grid. Groove templates extract the particular rhythmic feel of a recorded performance so that it can be applied to a MIDI sequence. Digi-Groove templates can be generated using Beat Detective (TDM systems only).

To open the Groove Quantize window, choose MIDI > Groove Quantize.

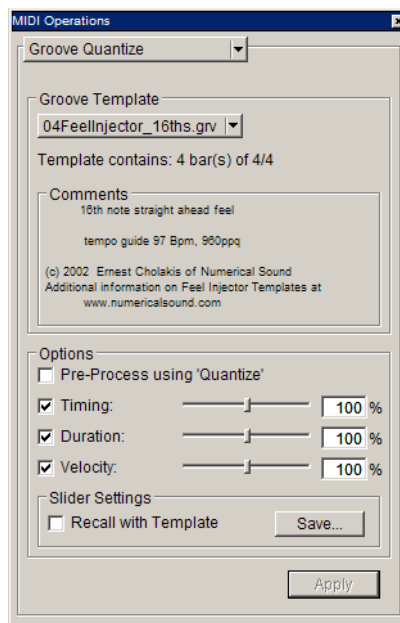

*Groove Quantize window*

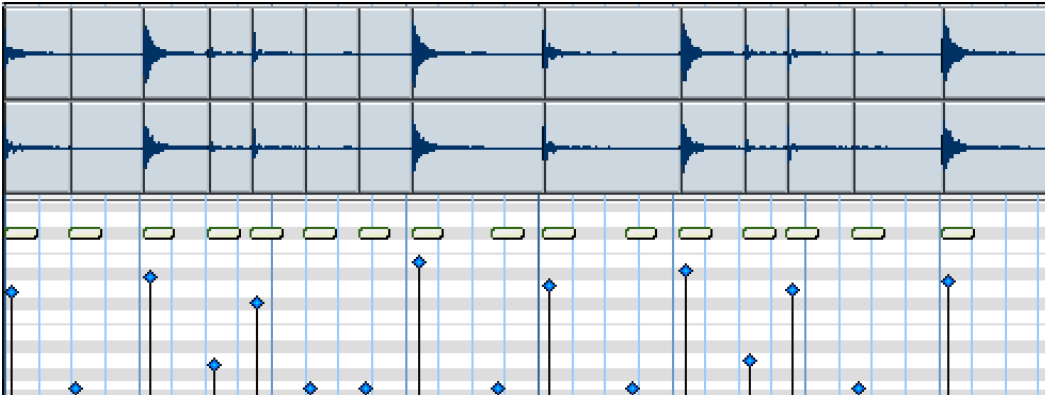



Figure 28. A DigiGroove template (derived from the audio shown) applied to a series of sixteenth-notes with Timing and Velocity both set to 100%

## Groove Template

Groove templates (such as DigiGroove templates) are “quantization maps” derived from real musical performances. The rhythmic character of each performance is analyzed and stored as a groove template. Groove templates can be used to transfer the feel of a particular performance to MIDI data (Timing, Duration, and Velocity).

DigiGroove templates can be created using Beat Detective (TDM systems only). Beat Detective analyzes an audio file for transient peaks according to a defined threshold and maps the rhythmic relationships to a 960 parts per quarter note (ppq) template. This template can then be used within Groove Quantize, as well as within Beat Detective.

 For information on Beat Detective and creating Groove Templates, see Chapter 22, “Beat Detective.”

Additionally, DigiGroove templates are available from Digidesign and third party manufacturers.

 Numerical Sound’s Feel Injector Templates (960 ppq) are supported in Pro Tools, but DNA Groove Templates (192 ppq) are not.

**Groove Template Pop-Up Menu** All groove template files in the Grooves folder are available in the Groove Template pop-up menu. The directory path for the Grooves folder is: C:\Program Files\Digidesign\Pro Tools\Grooves (Windows), or Applications/Digidesign/Pro Tools 6/Grooves (Mac OS X). If you organize your groove templates in sub-folders in the Groove folder, they will appear as sub-menus in the Groove Template pop-up menu. Once you have selected a groove template, specific information about the template’s meter and duration (in bars) is displayed under the Groove Template pop-up menu.

**Comments** The Comments field displays any comments saved with the Groove Template from Beat Detective. The Comments field cannot be edited in the Groove Quantize window, but can be edited when saving a groove template from the Groove Quantize window.

## Options

**Pre-Process Using Quantize** Enable to hard quantize the selected MIDI notes according to the Quantize command's settings before applying Groove Quantize.

The Pre-Process Using Quantize option is only available when the Timing option is enabled.

**Timing** Enable to apply Groove Quantize to the selected MIDI notes. Use the slider to change the amount of quantization applied to the selection. If the slider is set to 0%, there is no change in timing. A setting of 100% moves notes to the underlying template locations. If the slider is set to 200%, notes move to a tick location that is twice the difference between the original note location and the position of the referenced template event.

For example, if a note was played at Bar 1|1|060 (a 16th note), and the corresponding template event is at 1|1|073, a slider value of 100% results in the note being shifted to 1|1|073 (a slider value of 200% shifts the note to 1|1|086).

The default value for the Timing slider is 100%.

**Duration** Enable to influence the durations of the selected MIDI notes. At a setting of 100%, durations are changed to match the current groove template. Set to 200%, durations increase and decrease based on the ratio of the original duration of the selected notes and the durations in the template.

The default value for the Duration slider is 100%.

**⚠ Beat Detective does not currently extract duration information from audio performances. DigiGroove templates created using Beat Detective contain a fixed duration value that is 50% of the selected template resolution (see "Defining a Beat Detective Selection" on page 336).**

**Velocity** Enable to influence the velocities of the selected MIDI notes. If the slider is set to 0% there is no change to the selected velocities, a setting of 100% sets all velocities to match the current groove template. A velocity setting of 200% typically results in over-exaggerated velocities—loud notes increasing and soft notes decreasing in volume.

For example, if two adjacent notes have equal velocities of 80, and the two corresponding template velocities are 70 and 90, setting the slider to 200% changes both to velocities of 60 and 100.

The default value for the Velocity slider is 100%.

## Slider Settings

**To Save the groove template with the current Options Slider Settings:**

1 In the Groove Quantize window, click the Save button.

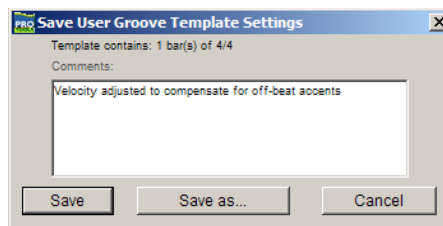

Save User Groove Template Settings

2 Enter or edit any comments you want to save with the template.

3 Click the Save button to save the groove template with the current Options Slider Settings.

– or –

Click the Save As button to make a copy of the groove template with the current Options Slider Settings. In the resulting Save dialog, enter a name for the copy and click Save.

Slider settings may be lost if any of the following operations are performed without saving the settings first:

- Another MIDI Operations pane is selected.
- The MIDI Operations window is closed.
- You switch to another groove template.

**Recall With Template** Restores all Groove Quantize Options to the settings that are saved with the current template.

## Applying Groove Templates

Groove templates can be of any length and can be applied to any number of bars. Typically, you will apply groove templates to selections of the same length and meter. However, groove templates can be applied to different meters—for example, a groove template in 6/8 can be applied to a selection in 4/4. Also, it is not necessary to start on the downbeat when making a selection to apply a groove template.

### To apply Groove Quantize:

1 Using the Grabber or Selector, select the MIDI notes you want to Groove Quantize.

2 Choose MIDI > Groove Quantize.

3 Select a groove template from the Groove Template pop-up menu.

4 Enable Timing, Duration, and Velocity, and adjust their sliders to the percentages you want.

5 If desired, enable Pre-Process using Quantize.

6 Click the Apply button.

## Mapping Groove Templates

Pro Tools applies groove templates relative to the song start. For example, a two-bar groove template repeats starting at every odd-numbered bar in the session (bar 1, 3, 5, 7...).

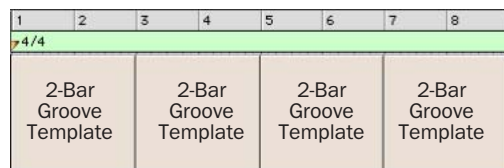

*2-bar groove template, repeating template grid*

### Template Mapping for Equal Meters And Odd Numbered Bars

If a two-bar groove template is applied to a selection of one bar of the same meter, only the first bar of the template is used. If the selection does not encompass bar boundaries, for example 1|2|000 to 2|1|000, the groove template will only modify the selected notes.

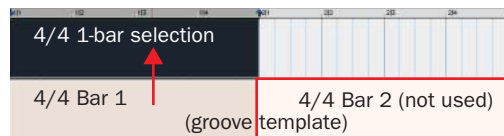

*Applying 2-bar groove template to a 1-bar selection, odd numbered bar*

## Template Mapping for Equal Meters And Even Bars

If a selection starts on an even bar, only the appropriate portion of the groove template will be used. For example, if the selection is two bars long and starts on an even bar, the template will apply bar 2 before bar 1.

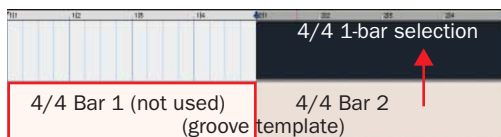

*Applying a 2-bar groove template to a 1-bar selection, even numbered bar*

## Template Mapping for Unequal Meters

In cases where the Groove Templates and track selections are based on different meters, the template will be repeated or truncated to match the number of beats in the selection.

For example, if the Groove Template contains fewer beats than the selection, such as a one-bar template in 6/8 being applied to a one-bar selection in 4/4, the template will repeat to make up the difference.

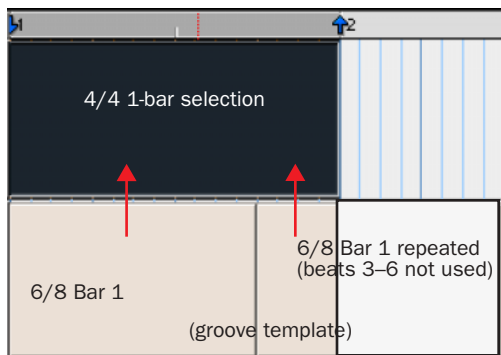

*Applying a 1-bar groove template in 6/8 to a 1-bar selection in 4/4*

If the Groove Template contains more beats than the selection on a track, such as a one-bar template in 6/4 being applied to a two-bar selection in 4/4, only the appropriate number of beats will be used.

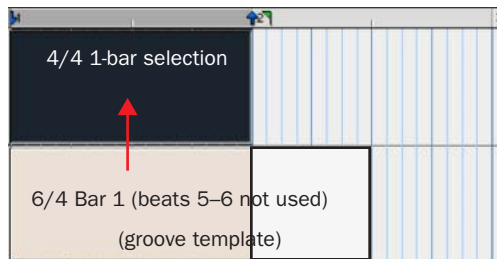

*Applying a 1-bar groove template in 6/4 to a 1-bar selection in 4/4*

## Behavior for Mixed Meters

If the selection contains mixed meters, the groove template will always be mapped so that the downbeats are aligned. For example, if the Groove Template consists of one-bar of 4/4 and it is being applied to a selection of one-bar of 4/4 followed by a bar of 3/8 and one-bar of 3/4, the

downbeat of the Groove Template will be aligned with the downbeats in the selection and only the appropriate number of beats from the Groove Template will be applied.

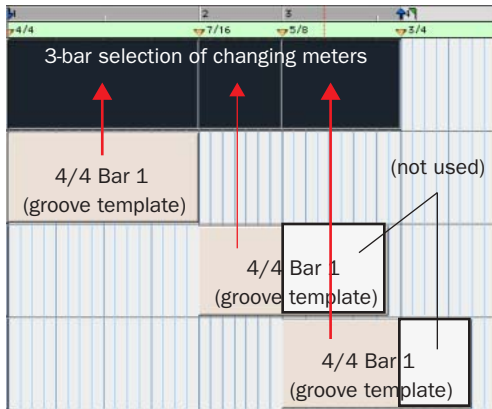

Applying a 1-bar groove template in 4/4 to a 3-bar selection in different meters

 You can reset the groove template grid by adding a new meter marker (it can be the same meter). The groove template will re-start at the meter marker regardless of the measure number or whether or not the meter has actually changed.

## Restore Performance

The Restore Performance command reverts all selected MIDI notes to their original state (when first recorded or manually inserted), even after the session has been saved, or the Undo queue has been cleared. The following MIDI note attributes can be restored:

- Timing (Quantization)
- Duration
- Velocity
- Pitch

 *The Restore Performance command can be undone.*

**To restore a note's original time, duration, velocity, or pitch:**

- 1 Using the Grabber or Selector, select the MIDI notes you want to restore.
- 2 Choose MIDI Operations > Restore Performance to open the Restore Performance window.

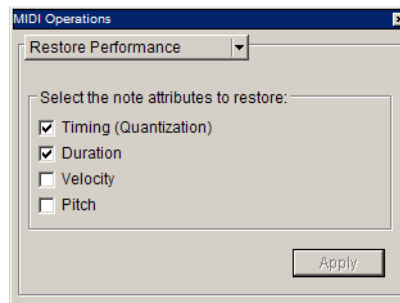

Restore Performance window

- 3 Select the note attributes to restore.
- 4 Click Apply.

Any changes made through the standard Quantize, Groove Quantize, Change Duration, Change Velocity, or Change Pitch commands will be undone and the original “performance” will be restored. Also, any notes that were recorded with Input Quantize enabled will be restored.

**⚠** *Restore Performance does not undo cut, copied, pasted, or otherwise manually moved MIDI notes.*

*Restore Performance also does not undo Duration changes made by trimming the start of a note. Trimming the start of a note is essentially changing the note’s timing, and therefore is treated by Pro Tools as manually moving it.*

**Timing (Quantization)** Enable to restore the original start times of the selected notes. This will change the durations of the notes if the Duration option is not enabled.

**Duration** Enable to restore the original durations of the selected notes. If the Timing (Quantization) option is not enabled, the start time of the note will not be restored and the note end time will be affected.

**Velocity** Enable to restore the original velocities of the selected notes.

**Pitch** Enable to restore the original pitches of the selected notes.

## Removing Input Quantize

Restore Performance can be used to remove quantization on input. For example, if you recorded a performance with Input Quantize on, you can still restore the performance as it was actually played.

---

## Flatten Performance

The Flatten Performance command “locks in” the current performance for selected notes, creating a new “restore to” state for the specified note attributes when using Restore Performance.

### To flatten the performance:

- 1 Using the Grabber or Selector, select the MIDI notes you want to flatten.
- 2 Choose MIDI Operations > Flatten Performance to open the Restore Performance window.

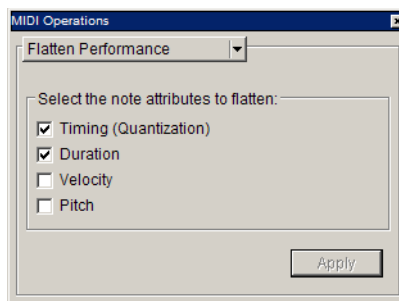

### Flatten Performance window

- 3 Select the note attributes to flatten.
- 4 Click Apply

**⚠** *The Flatten Performance command can be undone.*





# Chapter 25: MIDI Event List

## The MIDI Event List

The MIDI Event List displays a detailed list of all events in a single MIDI track. The events are displayed with text and numbers, allowing you to precisely edit their location, length, and event values.

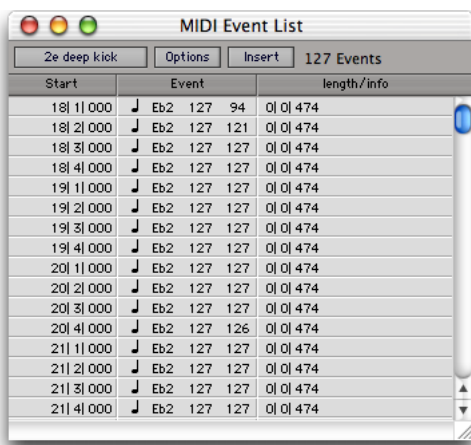

MIDI Event List

Events in the MIDI Event List can be copied and pasted, selected, or deleted. Any MIDI event (except Syssex) can be inserted and edited in the list. Certain MIDI event types can be hidden with the View Filter.

 Unlike playlists in the Edit window, you can insert and display polyphonic aftertouch in the MIDI Event List.

 Mute data for MIDI tracks is not displayed in the MIDI Event List.

## Opening the MIDI Event List

To open the MIDI Event List, do one of the following:

- Choose Windows > Show MIDI Event List.
- Start-double-click (Windows) or Control-double-click (Macintosh) a track name in the Edit or Mix window.
- Press Alt+Equal (Windows) or Option+Equal (Macintosh).

 You can also use Alt+Equal (Windows) or Option+Equal (Macintosh) to toggle between the MIDI Event List and the Edit window.

## Menus in the MIDI Event List

At the top of the MIDI Event List are three pop-up menus:

**MIDI Track Selector** Indicates the MIDI track currently displayed, and can be used to choose a different MIDI track to be displayed.

**Options Menu** Contains commands and options for the MIDI Event List (see “MIDI Event List Options” on page 400).

**Insert Menu** Contains a list of event types that can be inserted.

To the right of these pop-up menus, the number of displayed events is indicated.

## Columns in the MIDI Event List

Information for the events in the MIDI Event List is displayed in the following three columns:

**Start Column** Displays the start location, using the Main Time Scale, for each event. Locations can also be displayed in the Sub Time Scale when the Show Sub Counter option is selected in the Options pop-up menu.

The Playback cursor appears as a blue arrow (red, when tracks are record-enabled) in the Start column.

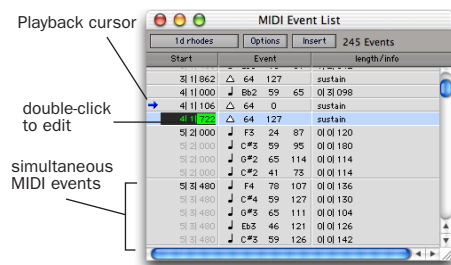

MIDI Event List columns

When several events reside at the same location, the location is only indicated for the top event, with the others dimmed. The dimmed locations can be edited by double-clicking them.

**Event Column** Displays the event type, indicated by an icon, and associated event values.

**Length/Info Column** Displays the end point or length for notes, depending on which option is selected in the Options pop-up menu. Also displayed are the names for continuous controller events and program changes.

## View Filter for MIDI Event List

You can use the View Filter to specify which event types are displayed in the MIDI Event List. This can help you zero in on only the events you want to affect; it also protects MIDI events from being edited or deleted. Events not displayed in the MIDI Event List still play back.

The View Filter can be set to display “all” messages, “only” the specified messages, or “all except” the specified messages.

**⚠** *When inserting an event type that has been filtered from the MIDI Event List, that event type will no longer be filtered.*

**For example, to filter the display of aftertouch and System Exclusive Messages in the MIDI Event List:**

**1** In the MIDI Event List, choose View Filter from the Options pop-up menu.

2 In the MIDI Event List View Filter dialog, select the All Except option.

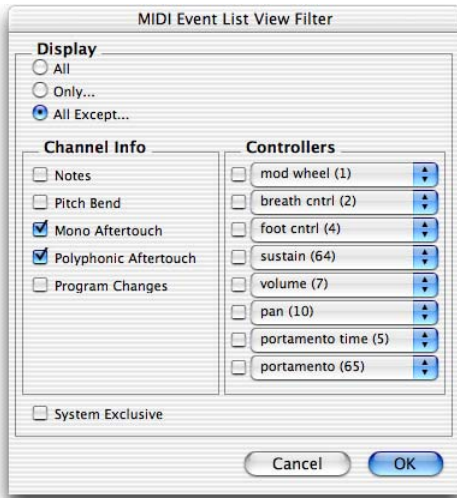

#### MIDI Input Filter

3 Select the options for Mono Aftertouch, Polyphonic Aftertouch, and System Exclusive. Leave all other messages deselected.

When using the All Except option, the selected events are not displayed. Conversely, when using the Only option, only the selected events are displayed.

4 Click OK.

### Navigating in the MIDI Event List

You can use the Tab and Arrow keys to move through the MIDI Event List. You can also locate to the Edit start point, or any other specified location.

**To move through the MIDI Event List, do one of the following:**

- Double-click to edit a value.

- Press Tab or the Down Arrow to move to the next event (with or without the edit field selected).
- Press Control+Tab (Windows) or Option+Tab (Macintosh) or the Up Arrow to move to the previous event (with or without the edit field selected).
- With an edit field selected, press the Right Arrow to move to the next edit field to the right.
- With an edit field selected, press the Left Arrow to move to the next edit field to the left.

To keep the last event selected, press Shift while moving to the next or previous event.

#### To go to the Edit start point:

- In the MIDI Event List, choose Scroll To Edit Selection from the Options pop-up menu.

#### To go to a specific location in the MIDI Event List:

- 1 In the MIDI Event List, choose Go To from the Options pop-up menu.
- 2 In the Go To dialog, choose a format from the Time Scale pop-up menu.

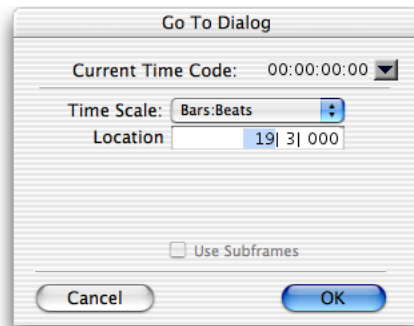

#### Go To dialog

If using Time Code (all TDM systems and Pro Tools LE systems with DV Toolkit only), you can select the Use Subframes option.

3 Enter the location you want to go to, then click OK.

The following items from the Options menu affect navigating in the MIDI Event List:

- When Page Scroll During Playback is selected, the MIDI Event List scrolls during playback.
- When Scroll During Edit Selection is selected, the MIDI Event List is scrolled automatically when the Edit selection changes in the Edit window.

## Inserting Events in the MIDI Event List

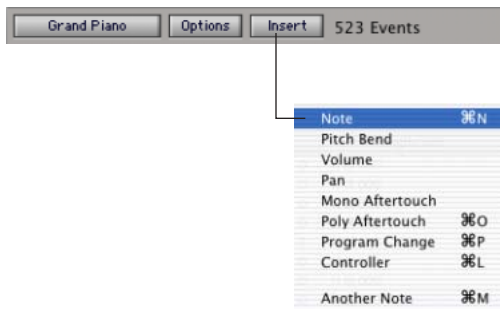

Insert menu, MIDI Event List

You can insert events in the MIDI Event List by choosing an event type from the Insert menu. Following are several examples of inserting events in the MIDI Event List.

### To insert a note in the MIDI Event List:

1 Click the Insert button and choose Note from the pop-up menu.

– or –

Press Control+N (Windows) or Command+N (Macintosh).

2 Enter the location, pitch, attack and release velocities, and length for the new note. To move between the Event Entry fields, use the Left and Right Arrow keys.

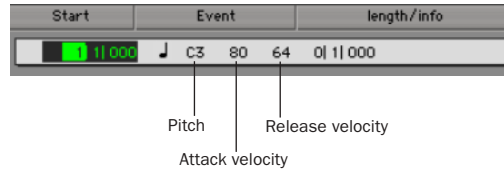

### Event Entry fields for note

When a field is selected, enter a value with any of the following methods:

- Enter the value on the numeric keypad.
- Drag up or down to scroll to the value.

**A** In Pro Tools 5.x, drag up or down while pressing Control (Windows) or Command (Macintosh) to scroll to the value.

- Play the note on your MIDI controller keyboard, then press Enter (Windows) or Return (Macintosh) on the alpha keyboard to confirm the value.

**💡** With the Start field selected, you can automatically enter the location of another event already in the track by clicking that event.

3 To insert the note and remain in Event Entry mode, press Enter on the numeric keypad.

– or –

To insert the note and exit Event Entry mode, press Enter (Windows) or Return (Macintosh) on the alpha keyboard.

– or –

To exit Event Entry mode, without inserting the note event, press Escape on the alpha keyboard.

### To insert a controller event in the MIDI Event List:

1 Click the Insert button and choose Controller from the pop-up menu.

– or –

Press Control+L (Windows) or Command+L (Macintosh).

2 Enter the location, controller “type” number, and controller value for the new event. The controller name is displayed in the Length/Info column, to the right of the controller value. To move between the Event Entry fields, use the Left and Right Arrow keys.

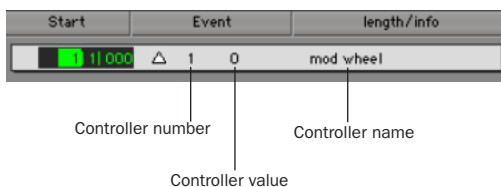

#### Event Entry fields for controller event

When a field is selected, enter a value with any of the following methods:

- Enter the value on the numeric keypad.
- Press the Up or Down Arrow to scroll to the value.
- While pressing Control (Windows) or Command (Macintosh), drag up or down to scroll to the value.
- Play the controller event on your MIDI controller keyboard, then press Enter (Windows) or Return (Macintosh) on the alpha keyboard to confirm the value.



*With the Start field selected, you can automatically enter the location of another event already in the track by clicking that event.*

3 To insert the controller event and remain in Event Entry mode, press Enter on the numeric keypad.

– or –

To insert the controller event and exit Event Entry mode, press Return on the alpha keyboard.

– or –

To exit Event Entry mode, without inserting the controller event, press Escape on the alpha keyboard.

### To insert a program change in the MIDI Event List:

1 Click the Insert button and choose Program Change from the pop-up menu.

– or –

Press Control+P (Windows) or Command+P (Macintosh).

2 Enter the location for the new event.

3 Enter a Program Change number and Bank Select value (if necessary). The program change name is displayed in the Info column.

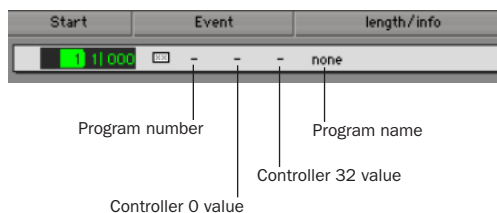

#### Event Entry fields for program change

You can click in the Info column to open the Program Change window (for details, see “Patch Select (Program and Bank Changes)” on page 366).



*With the Start field selected, you can automatically enter the location of another event already in the track by clicking that event.*

4 To insert the program change and remain in Event Entry mode, press Enter on the numeric keypad.

– or –

To insert the program change and exit Event Entry mode, press Return on the alpha keyboard.

– or –

To exit Event Entry mode, without inserting the program change, press Escape on the alpha keyboard.

## Inserting Another Event

After inserting an event, you can easily insert another event of the same type. The event type to be inserted is indicated at the bottom of the Insert menu.

**For example, after inserting a note, to insert another:**

■ Click the Insert button and choose Another Note from the pop-up menu.

– or –

■ Press Control+M (Windows) or Command+M (Macintosh).



*When the option for Insert At Playback Location is enabled (see “MIDI Event List Options” on page 400), you can use the keyboard shortcuts for inserting “another” event to insert events on-the-fly.*

---

## Editing in the MIDI Event List

Events in the MIDI Event List can be edited, selected, deleted, and copied and pasted.

**To edit an event in the MIDI Event List:**

1 Double-click the event field you want to edit.

– or –

To edit a selected event, press Control+Enter (Windows) or Command+Enter (Macintosh).

2 Enter a new value with any of the following methods:

- Enter the new value on the numeric keypad.
- While pressing Alt (Windows) or Option (Macintosh), press the Up or Down Arrow to scroll to a new value.
- While pressing Control (Windows) or Command (Macintosh), drag up or down to scroll to a new value.
- Play the new note or controller value on your MIDI controller keyboard, then press Enter (Windows) or Return (Macintosh) on the alpha keyboard to confirm the value.

3 To accept the new value, do one of the following:

- To enter the new event value and move to another field or event, use the Arrow keys.
- To enter the new value and remain in Edit Entry mode, press Enter on the numeric keypad.
- To enter the new value and exit Edit Entry mode, press Enter (Windows) or Return (Macintosh) on the alpha keypad.

– or –

To exit Edit Entry mode without entering the new value, press Escape on the alpha keyboard.

## Selecting in the MIDI Event List

### To select a range of events in the MIDI Event List:

- Click the event at the beginning of the selection and drag to the ending event.

– or –

- Shift-click the event at the beginning of the selection, then Shift-click the ending event.

### To select discontinuous events in the MIDI Event List:

- Control-click (Windows) or Command-click (Macintosh) each event.

### To remove an event from the selection in the MIDI Event List:

- Control-click (Windows) or Command-click (Macintosh) the selected event.



*Notes selected in the MIDI Event List can be modified by any of the commands in the MIDI Operations window. For details, see Chapter 24, “MIDI Operations.”*

## Deleting in the MIDI Event List

### To delete an event in the MIDI Event List:

- Alt-click (Windows) or Option-click (Macintosh) the event you want to delete.

### To delete a selection of events in the MIDI Event List:

1 Select the events you want to delete, by either dragging in the Start column, or by Shift-clicking each event.

2 To view only the events you want to delete, use the View Filter (see “View Filter for MIDI Event List” on page 394). Events not displayed cannot be deleted.

3 Choose Edit > Clear to delete all selected events.

– or –

Press Backspace (Windows) or Delete (Macintosh) on the alpha keyboard.

## Copy and Paste in the MIDI Event List

### To copy and paste in the MIDI Event List:

1 Select the range of events you want to copy by dragging in the MIDI Event List. To select discontinuous events, Control-click (Windows) or Command-click (Macintosh) each event you want to copy.

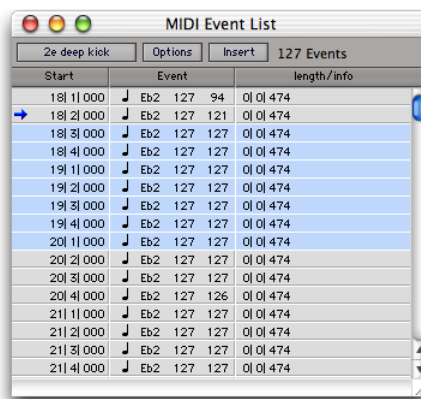

### Selecting in the MIDI Event List

2 Choose Edit > Copy.

3 To paste the material at an existing event's location, click the event in the MIDI Event List.

– or –

To paste the material at any location, choose Go To from the Options menu in the MIDI Event List, enter the location you want to paste to, and click OK.

4 Choose Edit > Paste. The events from the Clipboard are pasted, replacing any existing events already there.

 To paste events without overwriting other events, use the Merge Paste command.

## MIDI Event List Options

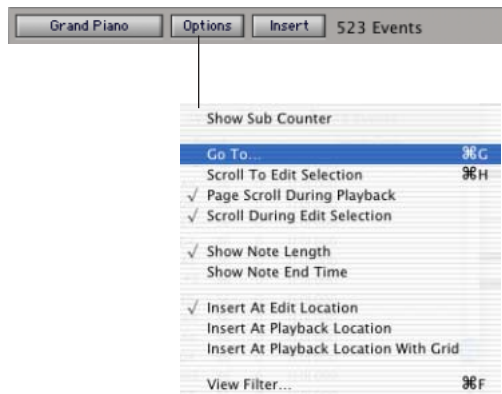

Options menu, MIDI Event List

**Show Sub Counter** Displays event times in the Sub Time Scale.

**Go To** Opens the Go To dialog, where you can specify a location, based on any of the supported Time Scales, to which the Edit insertion point is moved.

**Scroll To Edit Selection** Scrolls the MIDI Event List to the Edit start point or Edit insertion point.

**Page Scroll During Playback** Scrolls the MIDI Event List during playback.

**Scroll During Edit Selection** Scrolls the MIDI Event List automatically when the Edit selection changes in the Edit window.

**Show Note Length** Displays note lengths, instead of note end times, in the Length/Info column of the MIDI Event List.

**Show Note End Time** Displays note end times, instead of note lengths, in the Length/Info column of the MIDI Event List.

**Insert At Edit Location** Defaults the location for inserted events defaults to the Edit start point or Edit insertion point.

**Insert At Playback Location** Lets you insert events in the MIDI Event List in real time while listening to the session playback.

**Insert At Playback Location With Grid** Snaps the location for events inserted in real time to the grid.

**View Filter** Opens the View Filter dialog, where you can specify which events are displayed in the MIDI Event List. Events that are not displayed are not affected by Cut, Copy, and Paste operations in the MIDI Event List. Events that are not displayed still play back. For more information, see “View Filter for MIDI Event List” on page 394.



# Part VI: Mixing



# Chapter 26: Basic Mixing

In addition to the final mixdown, mixing tasks can occur any time during a recording session. This chapter covers Pro Tools mixing, including audio signal flow, output and bus paths, sends, and signal routing.

During mixing, real-time plug-ins and hardware inserts provide effects and signal processing (see Chapter 27, “Plug-In and Hardware Inserts”).

---

## Mixing Concepts

Mixing involves making decisions about elements such as volume levels, panning, and effects. These mixing decisions are initially based on what you hear in your studio. While you can control many variables in your studio (such as speakers and room acoustics), you cannot control the listening environment in which your final mix will be heard. The following tips include a few ways to make sure your mix will sound as good as possible to as many listeners as possible:

### Alternate Speakers and Reference

**Monitoring** Listen to your mixes on a variety of different speakers, to gauge how well the mix will translate. By listening to a mix through different playback systems, you are attempting to anticipate what the intended audience will hear.

**Reference Mixes** Tapes and discs of rough mixes let you audition mixes outside the studio in different listening environments.

**Format Compatibility Monitoring** Stereo mixes must often be mono-compatible. When you are mixing in multichannel surround, mixes may also need to be compatible with stereo or mono playback systems (see Chapter 30, “Surround Concepts”).

---

## Metering and Calibration

Meters provide a visual display of signal levels. They tell whether signal is getting to a channel, and how loud or soft a signal is relative to (above or below) “0.”

By calibrating all your equipment to standard reference levels, a consistent level can be achieved (and metered) among different recording devices in a studio, throughout a facility, or throughout an entire production chain of a feature-length film. For example, a level of, say,  $-18$  dBFS coming out of a DAT deck should play and meter at  $-18$  dBFS in Pro Tools.

 *For more information about calibrating your studio, refer to your Getting Started Guide. For audio interfaces that have trims (such as the 192 I/O), see the interface’s guide for calibration instructions.*

## Audio Signal Flow

Pro Tools provides three different types of audio tracks:

- Audio tracks
- Auxiliary Inputs
- Master Faders

Mono and stereo audio tracks are available on all Pro Tools systems.

Multichannel audio tracks and surround mixing formats require Pro Tools|HD-series or MIX-series systems.

Tracks can be identified in the Mix window by their Track Type icon:

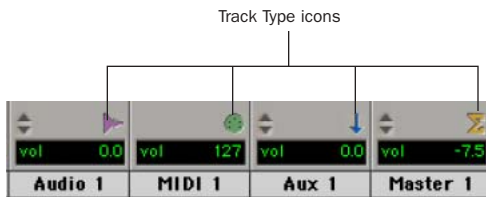

Audio, MIDI, Auxiliary Input, and Master Fader tracks

## Audio Tracks

Audio tracks play audio from disk, record audio to disk, or monitor input signals when record enabled, or in TrackInput monitoring mode. Inserts on audio tracks are pre-fader. Sends can be pre- or post-fader.

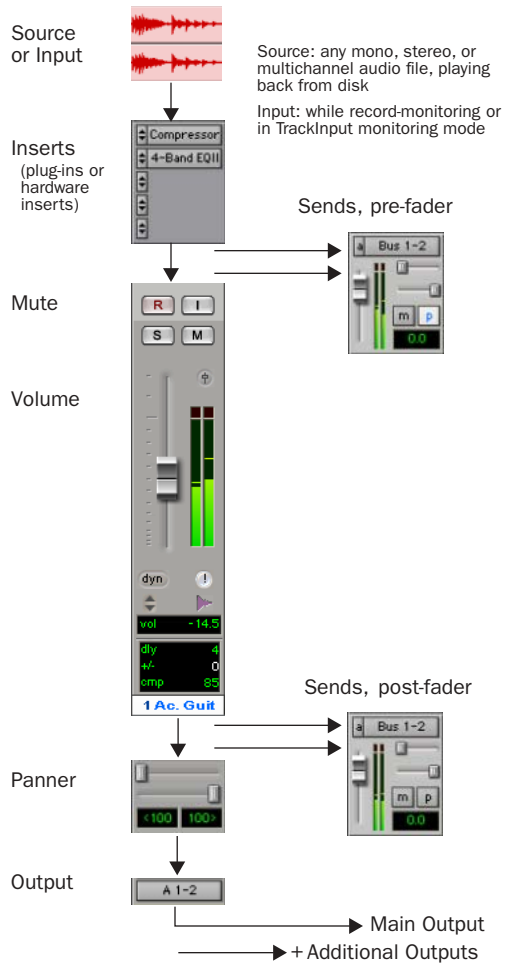

Audio signal flow, audio tracks

### To create an audio track

- 1 Choose File > New Track.
- 2 In the New Track dialog, specify the number of tracks.
- 3 From the Track Type pop-up menu, select Audio Track.
- 4 From the Track Format pop-up menu, select the number of channels (for example, Stereo).
- 5 Click Create.

## Auxiliary Inputs

Auxiliary Inputs provide the same signal routing options as audio tracks, except that their input must come from an internal bus or hardware input. Inserts on Auxiliary Inputs are pre-fader. Inserts on Auxiliary Inputs are pre-fader.

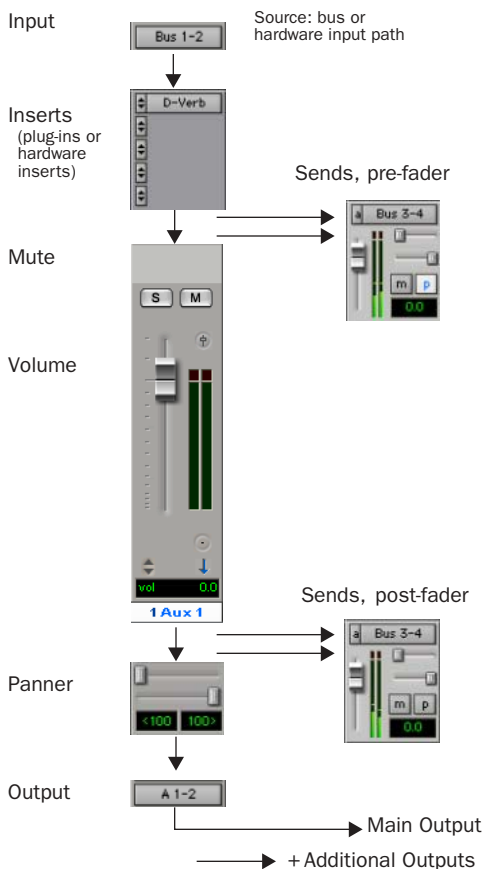

### Audio signal flow, audio tracks

Auxiliary Inputs are used as inputs for audio from MIDI devices and other sources, as well as to submix internal bus and output paths. They can be fully automated. When using Auxiliary Inputs as inputs for external sources, adjust the source output levels to achieve proper recording levels.

## Common Uses for Auxiliary Inputs

By bussing tracks to the Auxiliary Input, you can:

- Apply real-time plug-ins or an external processor to a submix, using the Auxiliary Input as an effects return
- Input MIDI and other audio sources into the mix, to monitor or route to audio tracks for recording to disk
- Consolidate control of any submix under a single fader (see “Submixing for Signal Routing and Effects Processing” on page 423)

### To create an Auxiliary Input:

- 1 Choose File > New Track.
- 2 In the New Track dialog, specify the number of tracks.
- 3 From the Track Type pop-up menu, select Aux Input.
- 4 From the Track Format pop-up menu, select the number of channels (for example, Mono).
- 5 Click Create.

### To route an Auxiliary Input:

- 1 Click the Input Selector of the Auxiliary Input and choose an input or bus path.
- 2 Click the Output Selector of the Auxiliary Input and choose an output or bus path.
- 3 Adjust the Auxiliary Input fader to set the return volume (it defaults to 0 dB).

 *Submix examples begin in “Submixing for Signal Routing and Effects Processing” on page 423.*

## Master Faders

Master Faders control the master output levels of output and bus paths. When assigned to an active output or bus path, they provide post-fader effects processing and master level control for a main mix, headphone and cue mixes, stems, effects sends, and other signal routing applications. Master Faders support all track formats supported on your Pro Tools system.

Input (source) determined by output assignment (of other tracks)

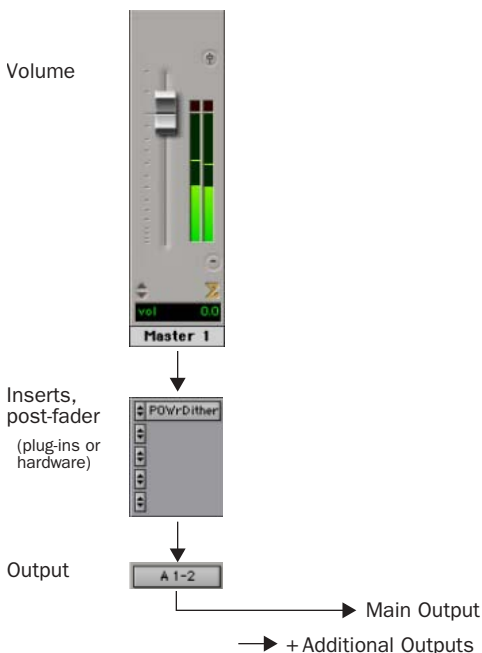

### Audio signal flow, Master Faders

Unlike inserts on audio tracks and Auxiliary Inputs, Master Fader inserts are post-fader. This lets you insert a dither plug-in, or similar plug-in, on your master mix. For more information about dithering, see “Dither” on page 430.

Master Faders provide up to five *post-fader* inserts and no sends. Also, Master Fader tracks do not have Pan controls, or Mute and Solo buttons.

 *If you absolutely must have a pre-fader insert on your Master Fader signal, set up an Auxiliary Input before the Master Fader.*

### Common Uses for Master Faders

Master Faders can be used to:

- Control and process output mixes
- Monitor and meter an output (such as a bus or hardware output) to guard against clipping
- Control submix levels
- Control effects sends levels
- Control submaster (bussed tracks) levels
- Apply dither or other inserts to an entire mix

Use Master Faders to control submix levels, send level masters, and other outputs. Master Faders do not consume any of your system's audio processing power.

### To create a Master Fader:

- 1 Choose File > New Track.
- 2 In the New Track dialog, specify the number of tracks.
- 3 From the Track Type pop-up menu, select Master Fader.
- 4 From the Track Format pop-up menu, select the number of channels (for example, Stereo).
- 5 Click Create.
- 6 In the Mix window, click the Master Fader's Output Selector and choose the output that you want to control. You can choose either audio interface outputs or internal busses. A Stereo Master Fader controls the level of a pair of outputs.

### To use a Master Fader as a stereo master volume control:

- 1 Create a stereo Master Fader track (as described above).
- 2 Set the outputs of all audio tracks in the session to the main output path (for example, outputs 1–2 of your primary audio interface) and set the panning of each track.
- 3 Set the output of the Master Fader to the main output path.

### Master Fader Meters

Meters on Master faders always show post-fader levels, regardless of the Pre-Fader Metering setting in the Operations menu.

### Master Faders and Paths

Master Faders can be assigned to main and sub-paths. When more than one Master Fader is assigned to the same output or bus path, only one can be active at the same time. If you try to assign a Master Fader to a main or sub-path that is already actively assigned on another Master Fader, the new assignment will be assigned, but be inactive. Master Faders can be assigned to different sub-paths of the same main path, as long as the sub-paths do not overlap.

### Active and Inactive Master Faders (TDM Systems and Pro Tools LE 6.x Only)

When a Master Fader track is inactive, its associated plug-ins, I/O assignments, and their resources are made inactive.

When a Master Fader output assignment (path assignment) is made inactive, the Master Fader no longer controls the master gain of that path.

When you duplicate a Master Fader track, the duplicated track's assignment will be inactive.

---

## Inserts

Pro Tools lets you insert up to five inserts on each audio track, Auxiliary Input, or Master Fader. Each insert can be either a software *plug-in insert* or a *hardware insert*.

Inserts provide the following features:

- Plug-ins and hardware inserts route the signal from the track through the effect of your choice, and automatically return it to the same track.
- Hardware inserts send and return the signal to corresponding input and output channels of an audio interface, to which you can connect outboard effects.
- Inserts on audio tracks and Auxiliary Inputs are pre-fader.
- Inserts on Master Faders are post-fader.
- Inserts can be bypassed or made inactive.
- Most plug-in controls are fully automatable.
- On TDM systems, RTAS plug-ins can be inserted on audio tracks, but not on Auxiliary Inputs or Master Faders.

 See Chapter 27, “Plug-In and Hardware Inserts” for details about using plug-ins and inserts.

## Track Output Format and Plug-Ins

Pro Tools supports mono, multi-mono, stereo, and (on systems that support surround mixing) multichannel plug-ins.

Because inserts process in series, changing the plug-in format can alter the channel format. For example, inserting a mono-to-stereo plug-in on a mono Auxiliary Input changes the signal path from that plug-in through the rest of the track. This restricts all hardware inserts or plug-ins after the stereo plug-in to be stereo-in/stereo-out plug-ins (or the supported multichannel format).

### Plug-In Formats

All Pro Tools TDM and LE systems support mono and stereo plug-ins. The following three types of plug-in paths are supported on all Pro Tools systems:

- mono-in/mono-out
- mono-in/stereo-out
- stereo-in/stereo-out

Pro Tools TDM systems running the Surround mixer also support 3–8 channel, multi-mono and multichannel plug-ins.

---

## Views in the Mix and Edit Windows

Both the Mix and Edit windows can be configured to show or hide various mixing controls. Comments, inserts, sends, and mic preamp views can be shown or hidden in both the Mix and Edit windows.

The I/O view is always shown in the Mix window and can be shown or hidden in the Edit window.



The Delay Compensation view is only available in the Mix window.

**To show or hide available views in the Mix and Edit windows:**

1 Choose Display > Mix Window Shows or Display > Edit Window Shows for one of the view types (such as Inserts View).

– or –

Click the View Selector in the Edit window.

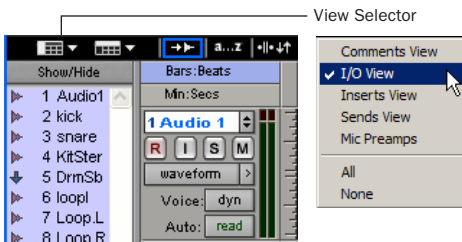

Selecting an Edit window view with the View Selector

2 Choose any or all of the following:

**Comments View** Shows any text entered as comments in the Track Name dialog. For more information, see “Naming Tracks” on page 91.

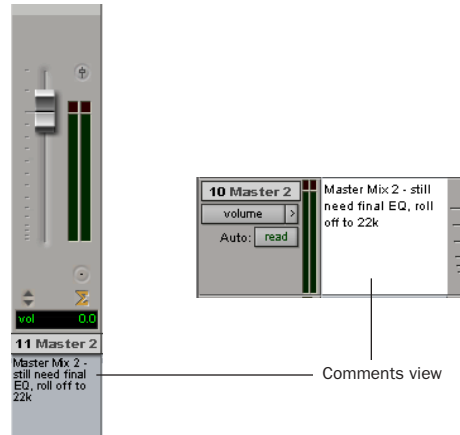

Comments View in the Mix and Edit windows

**I/O View (Edit Window Only)** Shows input and output, volume, and pan controls in each track. Deselect to hide.

**Inserts View** Shows inserts (software plug-ins and hardware I/O inserts) in each track. Deselect to hide.

**Sends View** Shows send assignments in each track. Deselect to hide. For more information, see “Configuring Sends View in the Mix and Edit Windows” on page 416.



Edit window views

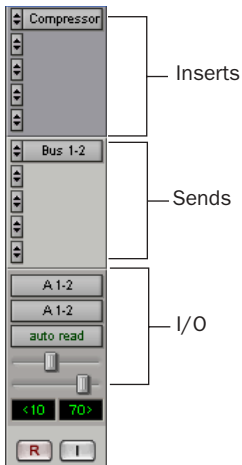

Mix Window views

**Mic Preamps View** Shows controls in each track for the Digidesign PRE. Deselect to hide. For detailed information, see the *PRE Guide*.



Mic Preamps view

**Delay Compensation View** The Delay Compensation View displays the total amount of plug-in delay on each track, lets you apply a user offset of track delay, and displays the total amount of delay that Pro Tools applies to each track. The Delay Compensation View can be shown in the Mix Window.

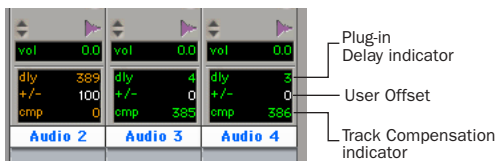

Delay Compensation view

**To view Delay Compensation information:**

- Choose Display > Mix Window Shows > Delay Compensation View.

Delay values can be specified in either samples or milliseconds, as determined in the Display page of the Preferences dialog. For more information, see “Delay Compensation” on page 428.

## Track Input

Input Selectors determine the source input for audio tracks and Auxiliary Inputs. Track input can be a hardware input, or bus. While recording, the Input Monitor mode determines when live input will be monitored through a record-enabled audio track.

You can also define what physical ports are routed to Pro Tools input ports in the “Main” page of the Hardware Setup dialog. For more information, see “Configuring Pro Tools System Settings (in the Playback System Engine)” on page 37.

**To assign track input:**

- Select an input path or sub-path from the track Input Selector.

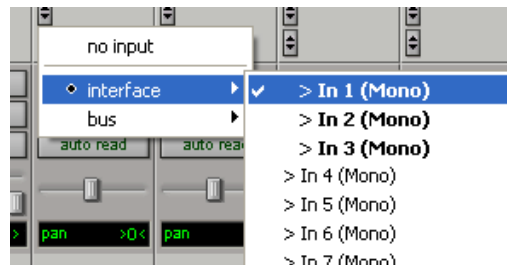

Selecting input path (Mix window)

### To assign multiple tracks to the same input:

- Alt-select (Windows) or Option-select (Macintosh) a track input to assign all tracks to the selected input.

– or –

- Alt-Shift-select (Windows) or Option-Shift-select (Macintosh) a track input to assign all selected tracks to the selected input.

### To assign multiple tracks to unique inputs (ascending, incrementing):

- Control-Alt-click (Windows) or Command-Option-click (Macintosh) a track input to assign it to an input path and auto-assign each subsequent track to the next available input path (moving top-to-bottom in the Edit window, left-to-right in the Mix window).

Auto-assigning is determined by the path format, and the active/inactive state of the tracks, as follows:

- Only tracks of a matching format (such as two mono tracks) will be auto-assigned.
- Only active tracks and outputs will be auto-assigned.

---

## Track Output

Track Output Selectors route the post-fader signals to the assigned output or bus paths.

The Output Selector routes the main track output to the chosen main or sub-path. Tracks can be routed directly to hardware outputs, or to internal bus paths for submixing (main or sub-paths).

The track format (mono, stereo, or multichannel) determines the available main and sub-path choices for track output.

When you create new tracks, their default Output assignment is determined by your selection of Default Output Path in I/O Setup. You can change the Default Output Path in I/O Setup to any available path. For more information, see “Default Output Path” on page 84.

 *Sends, and Send windows, provide another way to route track audio. See “Sends” on page 414 for more information.*

### To assign a track output:

- Select an output path or sub-path from the track Output Selector.

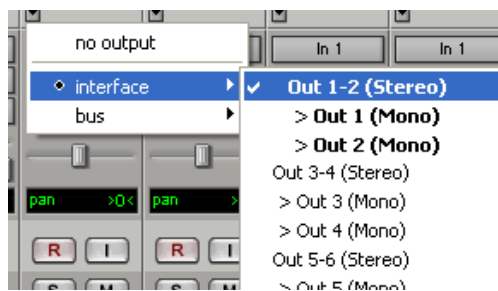

Assigning track output (Mix window)

### To assign all audio or Auxiliary Input tracks to the same output:

- Alt-select (Windows) or Option-select (Macintosh) a track output to assign all tracks to the same path.

### To assign all selected audio or Auxiliary Input tracks to the same output:

- Alt+Shift (Windows) or Option+Shift (Macintosh) a track output, to assign all selected tracks to the same path.

### To assign multiple tracks to unique outputs (ascending, incrementing):

- Control-Alt-click (Windows) or Command-Option-click (Macintosh) a track output to assign it to an output path and auto-assign each subsequent track to the next available output path (moving top-to-bottom in the Edit window, left-to-right in the Mix window).

## Output Paths

When audio tracks, Auxiliary Inputs, and Master Faders are created, their mono, stereo, or greater-than-stereo multichannel format is defined.

- Mono tracks can be assigned to any available mono, stereo, multichannel main and sub-paths.
- Stereo tracks can be assigned to any available mono, stereo, or multichannel main and sub-paths.
- Multichannel tracks can be assigned to any mono path, or path of the same number of channels (for example, an LCRS track can be assigned to a mono or LCRS path).

## Output Windows

Output windows provide the essential track mixing controls (such as track panning and volume), as an alternative to Mix and Edit window views. Multichannel Output and Send windows also provide expanded Panner views, and other surround-specific controls. (See Chapter 33, “Surround Panning and Mixing.”)

Output windows are useful in large sessions to leave important tracks in an anchored location, unaffected by Mix and Edit window (or control surface) banking. See “Output Windows for Tracks and Sends” on page 418.

These windows appear differently for mono, stereo, and multichannel tracks. For multichannel mixing, there is also an X/Y panner Output window available. For more information on using multichannel Output windows, see Chapter 33, “Surround Panning and Mixing.”

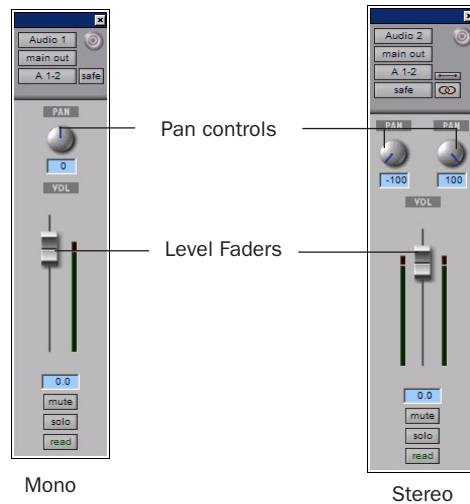

Output windows (mono and stereo tracks)

## Multiple Output Assignments

Pro Tools audio tracks and Auxiliary Inputs can have multiple track output and send assignments. Multiple outputs are limited only by the paths and resources available on your system.

Assigning to multiple paths is an efficient way to route an identical mix to other discrete outputs, for simultaneous monitor feeds, headphone mixes, or other situations where a parallel mix is needed. Master Faders can only be assigned to a single path.

You can also define what physical ports are routed to Pro Tools output ports in the “Main” page of the Hardware Setup dialog. For more information, see “Configuring Pro Tools System Settings (in the Playback System Engine)” on page 37.

#### To assign a track to multiple outputs:

- 1 Assign a main output path by selecting it from the track’s Output Selector.
- 2 Start-click (Windows) or Control-click (Macintosh) an additional output path in the track’s Output Selector. The newly selected output destination is added as an additional output.

 *Alt-Start-click (Windows) or Option-Control-click (Macintosh) to add the assignment to all tracks, or Alt-Shift-Start-click (Windows) or Option-Shift-Control-click (Macintosh) to add to all selected tracks.*

#### Display of Multiple Output Assignments

When a track is assigned to multiple output paths, the Output Selector denotes multiple assignment status and active/inactive status with the following indicators:

- A plus sign (+) indicates that the track has multiple output assignments.



*Indication of multiple output assignments*

- In the Output Selector menu, all currently assigned track outputs are checked to indicate they are active for the current track.
- An asterisk (\*) indicates that one or more currently assigned outputs is Inactive.

## Inactive Outputs

An output path can be made inactive, either globally in the I/O Setup window (affecting all tracks assigned to that path), or locally per assignment (only affecting that output on that audio track or Auxiliary Input).

When opening sessions, outputs will be made inactive automatically if the required hardware or other resources are not available.

Inactive outputs retain all associated automation playlists. Edits made in the session also affect the inactive track’s output automation playlists.

 *See “Making Tracks Inactive” on page 102.*

#### Inactive Outputs and DSP Resources

Making a track output inactive silences the output, while retaining all automation and playlist data. Inactive outputs do not consume resources for TDM mixer connections, but any assigned plug-ins on the track continue to use their required DSP resources. RTAS plug-ins require CPU resources, and TDM plug-ins use the DSP available on Pro Tools audio cards.

You can free up DSP of unused plug-ins by setting a track to inactive, or by setting just the plug-in to inactive.

 *See “Active and Inactive Items” on page 17, and “Making Inserts Inactive” on page 436 for more information.*

#### About the “No Output” Option

Track outputs can be set to No Output. Assigning a track output to No Output loses any panning automation associated with the track.

Tracks assigned to No Output will not be audible, but they do not free their associated DSP resources.

---

## Sends

Pro Tools lets you insert up to five sends on each audio track or Auxiliary Input.

Sends provide the following features:

- Sends can be set as pre- or post-fader.
- Send level and mute can be configured to follow Groups.
- Send level, send mute, and send pan (for stereo and multichannel sends) are fully automatable. See “Automating Sends” on page 460.
- Send controls can be displayed and edited from the Mix or Edit windows, or in their own output windows.
- Sends can be assigned to available output and bus paths (main or sub-paths), in mono or stereo, or any of the supported multichannel formats for surround mixing.
- Each send can have multiple assignments (for example, to available output and bus paths).

Sends must be returned to the mix through an Auxiliary Input or audio track to be audible in Pro Tools. They can be monitored and processed through an Auxiliary Input, recorded to audio tracks, and bounced to disk. (Bouncing and mix-down are explained in Chapter 29, “Mix-down.”)

## Assigning Sends to Tracks

**To add a send to a track:**

- 1 Make sure Sends View is enabled in the Mix or Edit window (see “Views in the Mix and Edit Windows” on page 408 for information).
- 2 Click the Sends button on the track and choose a path from the pop-up menu.

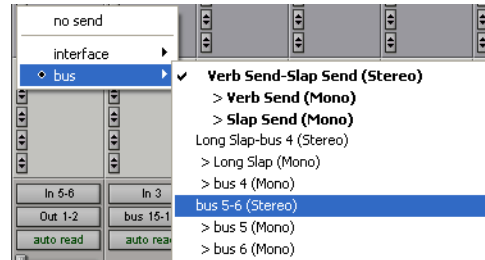

**Assigning a send to a stereo bus path**

The send can be a mono or stereo (or any of the supported multichannel formats for surround mixing) output or bus path.

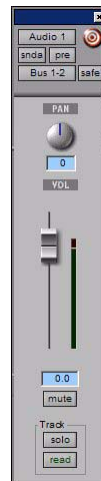

*Send window (mono)*

**3** Set the output level of the send in the Send window:

- Adjust the send level fader.
- or –
- Set the send level to unity gain (0 dB) by Alt-clicking (Windows) or Option-clicking (Macintosh) the send fader.

The first time you create a new send, its output level is automatically set to off, displayed on-screen as  $-\text{INF}$  ( $-\infty$ ).

#### **To change the default setting for sends:**

**1** Choose Setups > Preferences, and click the Operation tab.

**2** Select Sends Default to “ $-\text{INF}$ .”

– or –

Deselect Sends Default to “ $-\text{INF}$ ” and new sends will default to unity gain (0 dB).

#### **To remove a send from a track:**

- Click the Sends button on the track and choose No Send from the pop-up menu.

## **Send Formats**

**Mono and Stereo Sends** Available on all Pro Tools systems. When you click the Sends button on a track, you can choose from a list of mono or stereo output or bus paths.

**Multichannel Sends** Supported on Pro Tools|HD-series and MIX-series systems only

## **Send Path Choices**

The choices available in track Send Selectors include bus and output paths.

 *The names, format, and channel mapping of busses and output paths can be customized in the I/O Setup dialog. See “Creating and Editing Paths” on page 73.*

**Internal Mix Busses** Pro Tools TDM systems provide 64 busses and Pro Tools LE systems provide 16 busses for routing signals internally. Internal bus paths are useful for submixing and processing with plug-ins. Bus paths are defined in the I/O Setup dialog, and are available in all supported channel formats (mono, stereo, or multichannel, as supported on your system).

**Hardware Outputs** Hardware sends are often used for headphone cue mixes, or for sending signals to external effects processors. Sends do not automatically return audio as do hardware inserts.

## Configuring Sends View in the Mix and Edit Windows

Sends are displayed in the Mix and Edit window according to the Sends View Shows settings.

Choices include Assignments View, plus the five Send A–E Views, explained below.

### To display the controls for an individual send across all tracks:

1 If sends are not currently visible on your tracks, choose **Display > Mix Window Shows** (or **Edit Window Shows**) > **Sends View**.

2 Do one of the following:

- Choose **Display > Sends View Shows** and select the send (A–E).
- In Assignment View, Control-click (Windows) or Command-click (Macintosh) the Send Selector.
- When displaying sends in a Send A–E View, select the send (A–E).

### To show all send assignments:

- Choose **Display > Sends View Shows > Assignments**.

– or –

- When displaying sends in a Send A–E View, Control-click (Windows) or Command-click (Macintosh) the Send Selector and select Assignments.

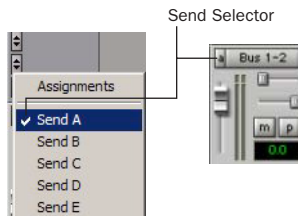

**Sends Views**

## Assignment View

This is the default Send Display mode, showing the five available sends on all tracks displayed in the Mix and Edit windows.

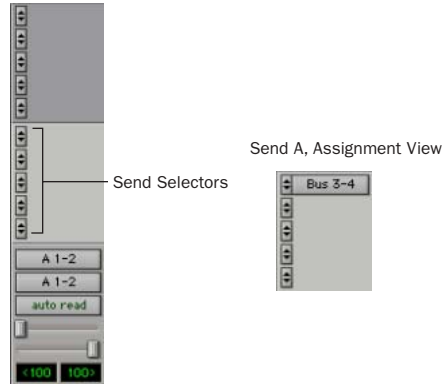

**Assignments View, no sends (left) and with an assigned send (right)**

In Assignment View, send controls are adjusted from Send windows. See “To view a different track Output or Send window:” on page 419.

## Send A–E Views

The Send A–E views provide send level, pan, and mute controls.

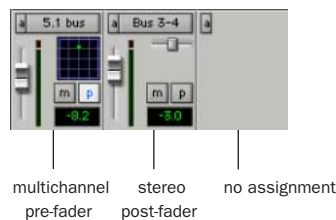

**Send A View, with different types of send assignments**

Send controls can be adjusted directly from these Send views. Sends can also be opened for control or metering in Send windows. See “Output Windows for Tracks and Sends” on page 418.



## Editing Sends in the Mix and Edit Windows (Send A–E Views)

Send A–E Views display all the controls of an individual send in the sends area of the Mix and Edit windows. These views provide full access to all controls for that send on all tracks.

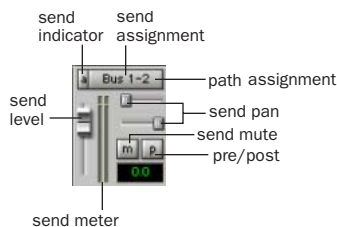

**Send A View, with stereo send shown**

Send level and mute can follow Mix groups, to adjust multiple send controls from a single set of controls. (See “Sends and Groups” on page 423.)

### Sends View Meters

When you display the controls for an individual send, you also have the option of displaying send level meters.

Send level meters show peak values and indicate clipping that occurs while the meter is displayed (if a send clips any time before its meter is displayed, this is not shown). If you are using a slower computer, hiding send level meters can improve screen redraw times.

#### To display send level meters when viewing individual sends:

- 1 Choose Setups > Preferences and click Display.
- 2 Select Show Meters in Sends View and click Done.

#### To clear a send meter’s Clip indicator:

- Click the Clip indicator.

#### To clear all meters, do one of the following:

- Option-click any Clip indicator.
- Choose Operations > Clear All Clips.
- Press Alt-C (Windows) or Option-C (Macintosh).

 *In Assignment View, edit sends by opening their Output windows. See “To view a different track Output or Send window:” on page 419.*

### Send Status Display

When displaying sends in a Send A–E View, the Send status is visible directly in the Mix or Edit windows.

In Assignment View, Send status is displayed as follows:

- By default, the Send button is grey, to indicate that it is unmuted.
- The Send button text is red when the send has clipped.
- The Send button is blue when the send is muted.
- The Send button is lit whenever a send’s window is open.

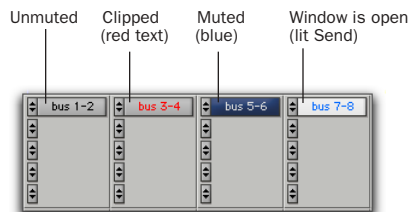

#### Indication of Send mute, clipping, and window status

If you use a control surface (such as D-Control, ProControl or Control|24) with Pro Tools, colored outlines around sends, inserts, and Outputs indicate the current controller focus.

## Inactive Sends

Sends can be made inactive. Inactive sends free their DSP and mixer resources, while retaining their position in track Sends View. Inactive sends do not output audio. However, Inactive sends retain all related automation playlists. In addition, any edits made in the session affect the sends automation playlists.

When opening sessions, sends will automatically be made inactive if the required hardware or other resources are not available.

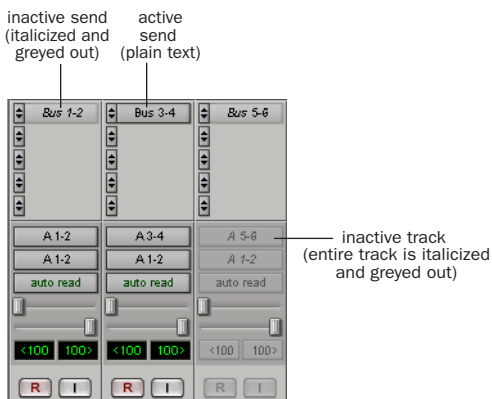

Display of inactive sends

### To make a send inactive:

- Control-Start-click (Windows) or Command-Control-click (Macintosh) on the Send assignment.

– or –

- Make the Track inactive. See “Making Tracks Inactive” on page 102.

### To toggle sends in the same position (A–E) on all tracks active or inactive:

- Control-Start-Alt click (Windows) or Command-Control-Option click (Macintosh) a send button in the position you want to toggle.

### To toggle sends in the same position (A–E) on all selected tracks active or inactive:

- Control-Start-Alt-Shift-click (Windows) or Command-Control-Option-Shift-click (Macintosh) a send button in the position you want to toggle.

## Output Windows for Tracks and Sends

Track outputs and sends can be opened for display and editing in dedicated windows.

- Track Output windows provide track fader, pan, automation, solo, and mute controls.
- Send windows provide send level, pan, automation, and mute controls.
- Standard Output and Send window controls provide additional routing, assignment, and display settings.

### To open a track Output window:

- Click the Output icon in the channel strip.

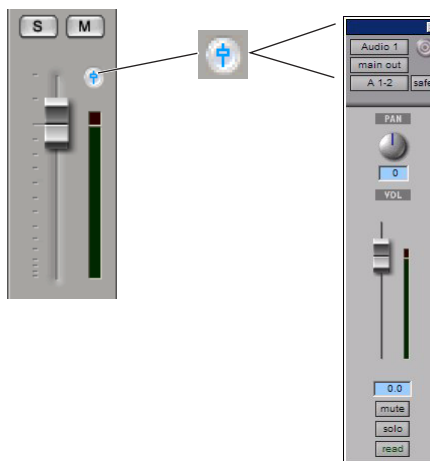

Opening a track Output window

### To open a Send window:

- Click the send in the Mix or Edit window.

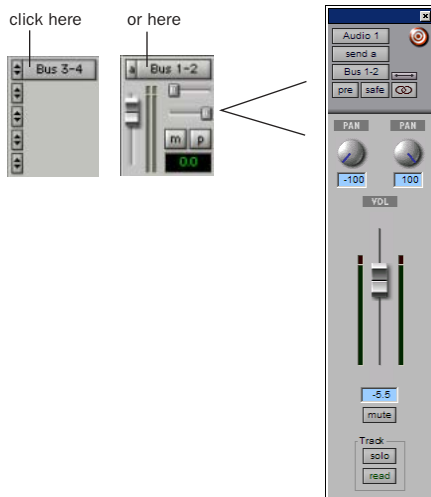

### Opening a Send window

#### To view a different track Output or Send window:

- Click an output icon, or send, in the Mix or Edit window.

If a similar Output window was already open with a highlighted Target icon (red, lit), the newly selected send will open in its place.

## Opening Multiple Output Windows

Multiple track and Send windows can be displayed simultaneously using either of the following methods.

#### To open additional Output windows:

- Shift-click any output icon or send.

#### To set a window to remain open when opening additional Output windows:

- Make sure the Target is disabled.



### Multiple Send windows

Arrange multiple windows as needed. For additional information, see “Targeted Windows” on page 422.

## Panner Linking

Stereo outputs provide two panning controls, one for each side of the left/right pair. Multichannel outputs provide a multichannel panner.

The Output window provides controls to unlink (or link) channels for precise panning of stereo and multichannel tracks.

In the default Linked mode, all sides match changes to any other side's pan control. This is Absolute Link mode. To mirror panning changes, see "Inverse Linked Panning" on page 420.

When unlinked, pan controls are completely independent of each other.



*Linked (left), unlinked (middle), front inverse linked (right) Output windows*

### To enable linking:

- Enable the Link icon.

### To unlink an output for independent panning:

- Deselect the Link icon.

## Inverse Linked Panning

When linked and set to Inverse mode, panning moves are inverted, or reversed, in the other channels.

Inverse panning reflects one side's location and direction in the other side. For example, when enabled for Front Inverse, if you pan one side of a stereo track output from right to left, the other side will exactly mirror that movement and pan left to right.

Front Inverse linking is available on all systems. Rear Inverse, and Front/Rear Inverse linking are available on Pro Tools|HD-series and MIX-series systems only, and only appear as options on multichannel plug-ins and panners/output windows.

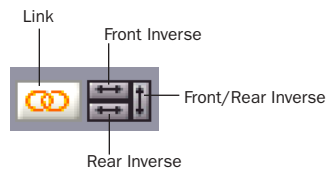

*Link, and Inverse Selectors (multichannel track)*

### To enable inverse linking:

- 1 Enable the Link icon.
- 2 Select an Inverse mode.

## Standard Selector Controls in Output Windows

All Output windows provide standard selectors for path, automation, and other controls in the top area of the window (the Output Editor area).

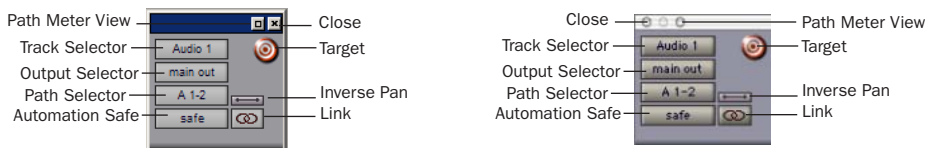

*Output window standard controls, Windows (left) and Macintosh (right)*

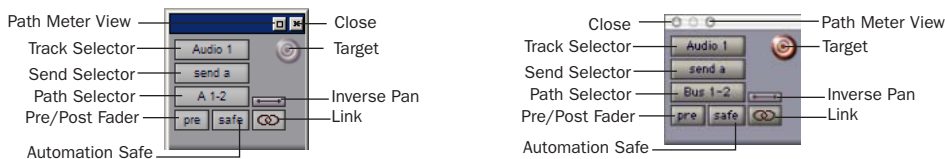

*Send window standard controls, Windows (left) and Macintosh (right)*

**Close** Closes the window.

**Track Selector** Provides access to any audio track, Auxiliary Input, or Master Fader in the session.

**Output Selector** Provides access to other outputs (track and send) in the track, if any, displaying the selected output in the current window.

**Send Selector (Send Window Only)** Provides access to other sends on the track.

**Path Selector** Allows you to assign the Output path for the current track or send.

**Pre/Post Fader (Sends Window Only)** Determines whether the send is pre- or post-fader.

**Automation Safe** Protects track and send level, pan, and other controls from automation overwrites by placing them in Automation Safe mode. See Chapter 28, “Automation” for more information.

**Inverse Pan** Reflects one side’s panning location and direction in the other side (for example, left- and right-channel pan controls).

**Link and Unlink** Allows linking and unlinking of left and right (or other) outputs in stereo (or multichannel). Unlinked mode provides discrete adjustment of individual sides, or channels. When linked, all changes affect all channels. See “Panner Linking” on page 420.

**Target** Identifies the target of plug-in settings commands. Also sets the current window for display of Output windows. See “Targeted Windows” on page 422.

**Meter View** opens the path Meter View. These meters display levels of the selected path (not the levels of the track or send).

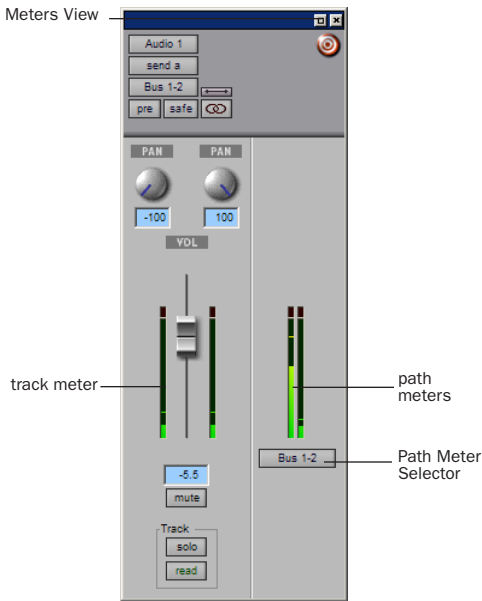

Meters View in a Send window

## Track Fader, Solo, Mute, and Auto

Output windows provide the associated track's volume fader, pan controls, solo and mute switches, and Automation Mode Selector. Use these to adjust or automate the controls of the Output window.

## Targeted Windows

When lit (red), the Target indicates its window is "targeted," and the next window opened of the same type replaces the current display (unless it is opened as an additional window with the Shift modifier). When unlit, the target is gray, and the current window anchors to its current contents and location on-screen. Opening additional windows does not affect anchored windows.

## To set an open Send window as the Target window:

- Click the Target, so that it is lit (red).

 *Plug-in windows have additional features related to the Target (such as Focus of Settings commands). See "The Plug-In Window" on page 440.*

## Using Output Windows

Output windows provide standard Pro Tools track, send, Target, and other controls.

## To move to a different track:

- Click the Track Selector button and choose a track from the pop-up menu.

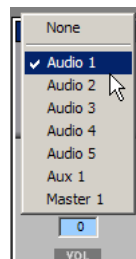

Selecting a track from the Output window

## To reassign output:

- Click the Path Selector button and select a path from the pop-up menu.



Selecting a path in the Output window

### To display the controls for a different send on the same track:

- Click the Send Selector button and select the send.

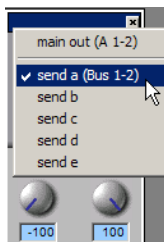

Accessing another send in the Output window

### To add a different send to the same track:

- Click the Send Selector button and choose an output or bus path from the pop-up menu, then click the Send Path Selector and choose a destination from the pop-up menu.

### To add an additional output assignment to the current send:

- Press Start (Windows) or Control (Macintosh) while selecting an additional output path from the Send Selector.

## Sends and Groups

Send level and mute can follow Mix groups in each of the five available sends (A–E). Use this option to adjust multiple send controls from a single set of controls.

### To configure sends and Mix groups:

- 1 Choose Setups > Preferences, and click the Automation tab.
- 2 Enable Send Level Follows Groups, or Send Mute Follows Groups.
- 3 Click Done to set the new Preferences.

 For more information on groups, see “Grouping Tracks” on page 103.

## Copying Track Settings to Sends (TDM Systems Only)

Sometimes you need send settings to match the settings in the track itself—for example, to provide a headphone mix based on the main mix.

### To copy track settings to sends:

- 1 Select the tracks you want to edit by clicking on the track names to highlight them.
- 2 Choose Edit > Copy To Send.

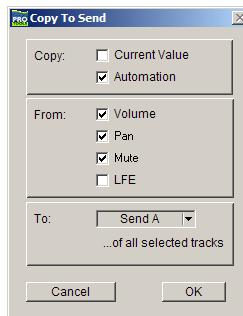

Copy To Send dialog

- 3 Select the controls you want to copy.
- 4 Select the sends you want to copy the settings to, and click OK.

---

## Submixing for Signal Routing and Effects Processing

The bussing and mixing features in Pro Tools support myriad possibilities for submixing and signal routing, including the ability to:

- Create inputs for MIDI devices and other audio sources, to monitor or record in Pro Tools.

- Control and automate any submix from a single fader and channel strip.
- Apply real-time plug-ins or an external processor to the submix, using the Auxiliary Input as an effects return.

## Audio Input from MIDI Devices and Other External Sources

You can use an Auxiliary Input to bring external audio sources such as MIDI devices, tape, microphone inputs, and instruments, into a Pro Tools mix.

### To use Auxiliary Inputs to bring external audio sources into a mix:

- 1 Connect the audio outputs of your MIDI and other external devices to available inputs on your Pro Tools audio interfaces.
- 2 If necessary, configure the I/O Setup dialog for the input paths you plan to utilize. The I/O Setup dialog configuration determines the choices available for track sends, inputs, busses, and hardware inserts. (For more information, see Chapter 7, “I/O Setup.”)
- 3 Specify the track type (Aux Input), and mono, stereo, or any of the supported multichannel formats for surround mixing.
- 4 Click Create.
- 5 Set the input of the Auxiliary Input track to the appropriate input path.
- 6 Assign the track output to the appropriate path, or paths. (See “Multiple Output Assignments” on page 412 for more information.)
- 7 Adjust the Auxiliary Input fader to control the track, and any assigned post-fader send levels.

## Mixing Audio Input from MIDI Devices and External Sources

By mixing MIDI and other audio sources through Pro Tools, you can apply mix automation to the volume, pan, mute, send level, send pan, send mute, and plug-in controls of the Auxiliary Input.

Auxiliary Inputs can be routed to audio tracks through internal send busses, or using their track output, to record them to disk.

Using plug-ins, inserts, and sends on Auxiliary Inputs, you can process instruments and other inputs with real-time plug-ins, or external devices. See “Send and Return Submixing for Effects Processing” on page 425.

## Creating a Submix

Audio is routed to a submix by assigning any combination of sends and track outputs to available bus or output paths.

Auxiliary Inputs can serve as effects returns by inserting plug-ins or external effects processors.

### Submixing with Track Outputs or Sends

You can use both track outputs and sends to route audio for submixing, depending on whether you want a *discrete* or *send and return* submix.

### Discrete Submix Output

Pro Tools lets you discretely route source audio through a submix. This is preferred for dither or other mastering processing, where you do not want unprocessed audio heard in addition to the processed signals. Use track outputs (not



sends) to assign tracks to a bus path for discrete submixing. In this arrangement, the balance of processed and unprocessed signal is controlled by plug-in wet/dry settings.

 For another way to submix effects, see “Send and Return Submixing for Effects Processing” on page 425.

#### **To create a discrete submix:**

- 1 Set the output of the tracks you want to include in the submix to a stereo bus path.
- 2 Pan each track.
- 3 Choose File > New Tracks.
- 4 Specify the track type (Aux Input) and format (stereo), then click Create.
- 5 Set the input of the Auxiliary Input to the same bus path to which you assigned all contributing tracks.
- 6 Set the output of the Auxiliary Input track to your main stereo mix outputs (typically, outputs 1–2).
- 7 Set the Auxiliary Input Track level.
- 8 To process the submix, assign a plug-in or hardware insert on the Auxiliary Input.
- 9 Set the controls of the plug-in. The plug-in Bypass and Wet/Dry controls (if available) determine the amount of effect heard.

The contributing track faders control the balance within the submix. The Auxiliary Input track controls the output levels of all tracks routed to it.

You can apply mix automation to the volume, pan, mute, and send level, send pan, and send mute controls of the Auxiliary Input.

You can also bounce a submix to disk to free up the voices for use by other tracks. See Chapter 29, “Mixdown” for information.

## **Send and Return Submixing for Effects Processing**

When you are submixing for reverb, delay, and similar effects processing, use sends to achieve traditional send/return bussing. You can use a real-time plug-in or a hardware I/O insert as a shared resource for all tracks included in a submix. The wet/dry balance in the mix can be controlled using the track faders (dry level) and Auxiliary Input fader (effect return, or wet, level).

 See Chapter 27, “Plug-In and Hardware Inserts” for more information.

### **Send and Return with a Plug-In or Hardware Insert**

#### **To create an effects return submix with a plug-in or hardware insert:**

- 1 Assign each track’s main output to your main mix outputs.
- 2 On the source tracks, assign a send (mono or stereo) and select a mono or stereo bus path from the send’s Output Selector. Configure the sends for pre- or post-fader, as needed.
- 3 Choose File > New Tracks.
- 4 Specify the track type (Aux Input) and format (stereo), then click Create.
- 5 From the Auxiliary Input track’s Input Selector, select the send bus path.
- 6 Assign a plug-in or hardware insert on the Auxiliary Input.
- 7 Set the effect to “100% wet,” and set any other controls as needed.

**8** From the Auxiliary Input track's Output Selector, select an output path (main outputs).

Adjust the individual track faders to balance the dry (unprocessed) tracks. The amount of effect is controlled by the level of the Send fader or the Auxiliary Input fader.

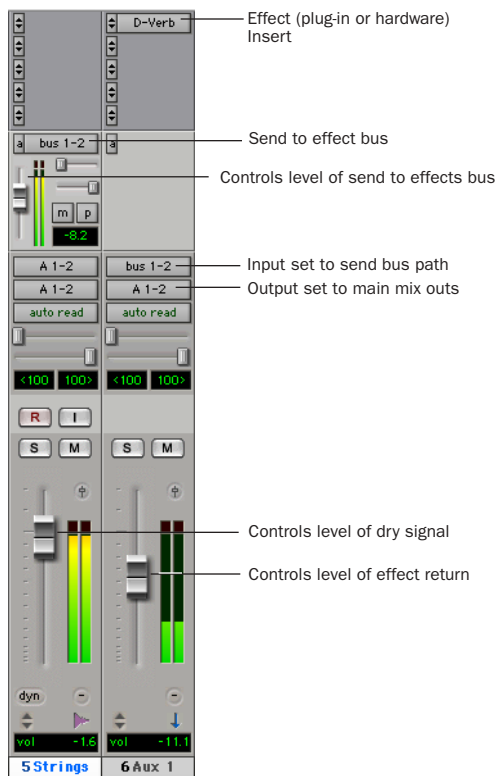

*Send/return setup for a plug-in or hardware insert*

### Send and Return with an External Device

**To create an effects return submix with an external device:**

**1** Assign each track's main output to your main mix outputs.

**2** Assign a send (mono or stereo) and set the send destinations on the source tracks to the output path connected to the external device. Configure the sends for pre- or post-fader, as needed.

**3** Choose File > New Tracks.

**4** Specify the track type (Aux Input) and format (stereo or mono), then click Create.

**5** From the Auxiliary Input track's Input Selector, select the input path connected to the external device.

**6** From the Auxiliary Input track's Output Selector, select an output path (main outputs).

Adjust the individual track faders to balance the dry (unprocessed) tracks. The amount of effect is controlled by the level of the Send fader or the Auxiliary Input fader.

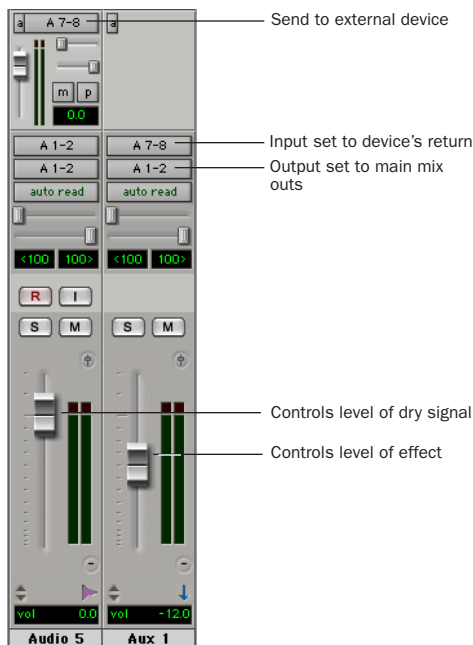

*Send/return setup for an external device*

## Creating a Master Send Level Control

A Master Fader can control the overall level of bus and output paths.

### To create a Master send level control:

- 1 Choose File > New Track.
- 2 Specify the track type (Master Fader), and mono, stereo, or any of the supported multi-channel formats for surround mixing.
- 3 Click Create.
- 4 Do one of the following:
  - Set the output of the Master Fader to the same path that you are using to send to an Auxiliary Input track.
  - Set the output of the Master Fader to match the path that you have chosen for your effects send.

You can then adjust send levels to balance the source tracks, and use the Master Fader as a master level control for the entire submix.

## Soloing Tracks in a Submix

Before you solo any tracks in a submix, you can solo safe the Auxiliary Input track to eliminate the necessity of having to also solo the Auxiliary Input (to hear any effects) when you solo a source track.

### To solo safe an Auxiliary Input:

- Control-click (Windows) or Command-click (Macintosh) the Solo button on the Auxiliary Input track.

### To solo an individual track that is part of a group:

- Start-click (Windows) or Control-click (Macintosh) the Solo button.

## Generating Stereo Output from a Mono Send/Return

You can use an Auxiliary Return arrangement to generate a stereo output from a mono send. Set the send destination to a mono Auxiliary Input track and place a mono to stereo plug-in on the Auxiliary Input. The output of the Auxiliary Input becomes stereo.

To create a “stereo” effect from a mono source, you must use “reverb” or “delay” effects.

---

## Delay Compensation

### (HD-series Systems with Pro Tools 6.4 Only)

Pro Tools provides Delay Compensation for managing DSP delays that occur on audio tracks, Auxiliary Inputs, or Master Faders because of plug-in use and mixer routing.

Pro Tools maintains time-alignment between tracks that have plug-ins with differing DSP delays, tracks with different mixing paths, tracks that are split off and recombined within the mixer, and tracks with hardware inserts.

To maintain time alignment, Pro Tools adds the exact amount of delay to each track necessary to make that particular track's delay equal to the delay of the track that has the *longest* delay.

Delay Compensation should be enabled during mixing and playback for optimal delay compensated sound. In some cases, Delay Compensation should be turned off when recording.

#### To enable Delay Compensation:

- Choose Operations > Use Delay Compensation.

## Delay Compensation Settings

There are three settings in the Playback Engine dialog for dedicating DSP resources for Delay Compensation:

**None** Allocates no DSP resources for automatic delay compensation.

**Short** Allocates minimal DSP resources of delay compensation for each channel. This is the most efficient setting for Pro Tools|HD Accel systems.

**Long** Allocates maximum DSP resources of delay compensation for each mixer channel. Long delay compensation uses the same DSP resources used by high DSP overhead plug-ins.

#### To configure the Delay Compensation Engine:

- 1 Choose Setups > Playback Engine.
- 2 From the Delay Compensation Engine pop-up menu, select a Delay compensation setting.
- 3 Click OK.

The delay compensation option will be saved as a session and system preference.

## Delay Compensation View

The Delay Compensation View displays the total amount of plug-in delay on each track, lets you apply a user offset of track delay, and displays the total amount of delay that Pro Tools applies to each track. The Delay Compensation View can be shown in the Mix Window.

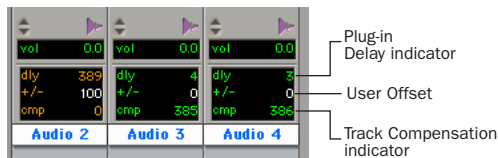

#### Delay Compensation view

#### To view Delay Compensation information:

- Choose Display > Mix Window Shows > Delay Compensation View.

Delay values can be specified in either samples or milliseconds, as determined in the Display page of the Preferences dialog.

## Plug-In Delay (dly) Indicator

This indicator shows the total plug-in and hardware insert delay on the track. This delay total is used by Pro Tools to calculate the delay applied to other tracks to keep them time-aligned. The track with the highest plug-in and insert delay displays delay information in orange.

Bypassing the track's reported delay to Pro Tools can be useful if your total plug-in delay on a track exceeds the amount allowed in the Delay Compensation Engine setting. After bypassing the track's reported delay, you must manually nudge your track earlier by the reported amount to achieve the proper delay compensation for that track, while continuing to use Delay Compensation (see "User Offset (+/-) Field" on page 429.)

### To bypass reporting plug-in delay to Pro Tools:

- Start-Control-click (Windows) or Command-Control-click (Macintosh) the Plug-in Delay indicator. The track delay will appear greyed out, and Pro Tools will not use that track's plug-in delay to calculate Delay Compensation for the other tracks.

## User Offset (+/-) Field

This field lets you adjust track delays manually. In addition to the automatic delay, positive or negative delay times can be entered in the user offset (+/-) field.

This is useful for changing the feel of a track or for time-aligning a track in case a plug-in is incorrectly reporting its delay.

### To change track delay using the User Offset field:

- 1 In the Delay Compensation view, click in the User Offset edit field.

- 2 To set your delay value (in samples or milliseconds depending on your current preferences), do one of the following:

- Enter a positive number (with or without the "+" modifier) or negative number (with the "-" modifier.)
- Control-drag (Windows) or Command-drag (Macintosh) in the User Offset field to scroll to a new value.
- Press the Up and Down Arrow keys to increase or decrease the numerical values.

- 3 Press Enter.

### To bypass the user delay:

- Start-Control-click (Windows) or Command-Control-click (Macintosh) the User Offset field. The user defined delay will appear greyed out, and it will no longer be applied to the track.

## Track Compensation (cmp) Indicator

This indicator shows the amount of compensation Pro Tools applies to each track.

## Delay that Exceeds the Compensation Limit

When the total delay on a track exceeds the amount of compensation available, Pro Tools applies the maximum available compensation, and displays the delay information in red (in the Delay Compensation View) for any tracks that cannot be fully compensated. The Delay Compensation indicator in the Edit window also turns red to indicate that the track delay exceeds the delay compensation limit. In this case, you need to bypass the track's reported delay (see "Plug-In Delay (dly) Indicator" on page 429), then manually nudge the track to maintain proper delay compensation (see "User Offset (+/-) Field" on page 429).

## Low Latency Monitoring During Recording

For recording, Pro Tools automatically suspends delay compensation to provide a low-latency monitor path through the main outputs of the record-enabled tracks. When an audio track is TrackInput-enabled, armed for recording (in stop), or punched in, the track's delay compensation is automatically suspended (and the Track Compensation indicator displays 0).

Delay compensation can be intentionally applied to audio tracks regardless of input mode.

### To apply delay compensation to automatically bypassed tracks:

- Start-Control-click (Windows) or Command-Control-click (Macintosh) the Track Compensation indicator. Track delay will be applied to the track and the Track Compensation Indicator will display in blue.

## Track Compensation on Auxiliary Inputs

Delay compensation on Auxiliary Inputs can be bypassed to let you monitor outside sources (such as the audio tracks of a slaved video deck) with minimal latency, while still reporting the track's delay.

### To bypass an Auxiliary Input's delay compensation:

Start-Control-click (Windows) or Command-Control-click (Macintosh) the Track Compensation indicator. The reported track delay will be zero, and will appear greyed out.

---

## Dither

Dither is a special form of randomized noise used to mask quantization noise in digital audio systems. Digital audio's poorest distortion performance exists at the lowest end of the dynamic range, where quantization distortion can occur. Dither reduces quantizing errors by introducing very low-level random noise, thereby minimizing distortion artifacts as audio reaches low level. With dither there is a trade-off between signal-to-noise performance and less-apparent distortion. Proper use of dither lets you squeeze better subjective performance out of a 16-bit data format (such as Red Book compact discs).

Pro Tools TDM systems process all audio internally at 24-bit, and Pro Tools LE processes internally at 32-bit, floating. Without Dither to process the 24-bit data to 16-bit, the extra 8 bits are truncated (dropped entirely) when written to media or a device with a 16-bit maximum (such as CD recorders, and many DAT machines). Dithering, on the other hand, preserves low-level (quiet) fidelity in a surprising way—by adding a small amount of noise to a signal.

## Dither in Pro Tools

There are several dither options provided in Pro Tools. Each has a specific application within the various operations that could benefit from dithering.

In addition to the TDM, RTAS and AudioSuite dither plug-ins, Pro Tools has a built-in dither capability.

### Dither Mixer Plug-Ins (Pro Tools|HD Systems Only)

There are two Mixer plug-ins that feature dither with noise shaping: Stereo Dithered and Surround Dithered. For more information, see “Surround Dithered and Stereo Dithered Mixers” on page 607. Standard Stereo and Surround Mixers do not have dither and require use of dither plug-ins.

**Dither on Final Output for Mixdown** You can insert a real-time dither plug-in on a Master Fader that controls your output mix, to dither your final mix for CD or other 16-bit media. Inserts on Master Fader process post-fader. This form of dithering lets you use dither plug-ins from Digidesign or third-party manufacturers. To use dither when recording to disk (Bounce to Disk), see “Dither and Bounce to Disk” on page 480.

**AudioSuite Dither** For AudioSuite plug-in processing, dither is based on the Dither plug-in.

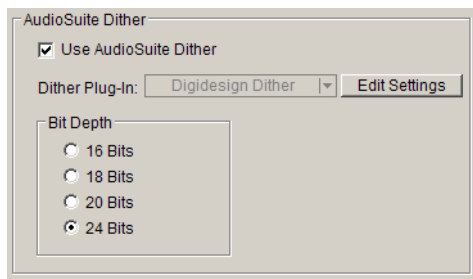

Operation Preferences, for AudioSuite dither

For most AudioSuite plug-ins, dither can be automatically applied in the Pro Tools Preferences dialog, under Processing. The Use AudioSuite Dither checkbox enables a preset, N-shaped dither.

The following AudioSuite plug-ins can automatically apply dither when processing:

- EQ II
- Compressor II
- Limiter II
- Gate II
- Expander/Gate II
- Normalize
- Gain
- DC Offset Removal
- Time Compression/Expansion
- Pitch Shift

 For information about AudioSuite Dither, see the *Digi-Rack Plug-Ins Guide*.

**Fades and Crossfades** In the Fades dialog (Edit > Fades > Create Fades), the Use Dither checkbox enables a preset, noise-shaped dither.

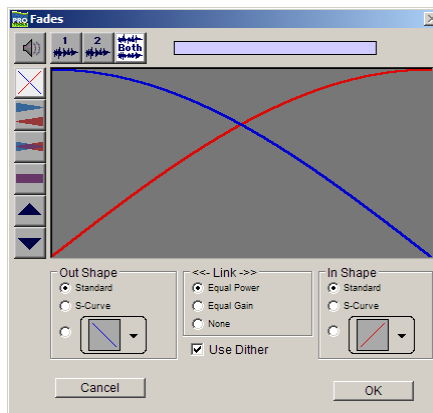

Create Fades dialog

## Noise Shaping

Noise is an integral part of the dithering process. *Noise shaping* can further improve audio performance and reduce perceived noise inherent in dithering. Noise shaping utilizes digital filtering to move noise from frequencies around 4 kHz to near the Nyquist frequency. Essentially, noise shaping lessens our perception of the noise inherent in dithering by shifting audible noise components into a less audible range.

Noise Shaping is available in the Dither plug-in.

 *For more information about dither during mixdown, see Chapter 29, “Mixdown.”*

---

## Using a Control Surface with Pro Tools

Control surfaces add hands-on control to Pro Tools functions. You can use a control surface to adjust on-screen faders and knobs, activate transport controls, or scrub and shuttle in Pro Tools.

There are several optional control surfaces for mixing in Pro Tools:

- Digidesign’s D-Control, an innovative tactile worksurface that employs a familiar, intuitive channel strip/center section console layout.
- ProControl and Control|24, dedicated controllers that provide access to Pro Tools recording, mixing, editing, signal routing, plug-in control, and automation features.

- Digidesign’s Command|8, a low cost USB-based control surface for Pro Tools, developed in a collaboration between Digidesign and Focusrite. Command|8 is a compact, convenient, and flexible control surface for Pro Tools systems running on Windows XP or Mac OS X.

 *For more information on using MIDI control surfaces with Pro Tools, refer to the Pro Tools MIDI Control Surfaces Guide.*



# Chapter 27: Plug-In and Hardware Inserts

Pro Tools provides up to five unity-gain inserts on each audio track, Auxiliary Input, or Master Fader. Audio track and Auxiliary Input inserts are pre-fader, and Master Faders inserts are post-fader only.

An insert can be either a software DSP *plug-in* or a *hardware insert*. A Pro Tools insert routes the signal from the track to a plug-in or external hardware effect of your choice and automatically returns it to the same track. Inserts do not alter the original audio source files, but process audio in real time, during playback. You can permanently apply real-time effects to tracks by recording or bouncing the effect to disk (see Chapter 29, “Mixdown” for more information).

**Plug-In Inserts** Plug-in inserts are software inserts that process audio material on a track in real time. For example, the EQ, Dynamics, and Mod Delay plug-ins supplied with your Pro Tools system are real-time plug-in inserts.

 For more information about the plug-ins supplied with your Pro Tools system, see the *DigiRack Plug-Ins Guide*.

Additional real-time plug-ins are available from Digidesign and from many third-party developers.

 For information about optional Digidesign plug-ins, see the electronic *Digidesign Plug-Ins Guide*. For information about third-party plug-ins, visit the Digidesign Web site ([www.digidesign.com](http://www.digidesign.com)).

**Hardware I/O Inserts** Hardware I/O inserts can route audio through an external device connected to parallel inputs and outputs of an audio interface. You can process the audio material on a track with a hardware insert in real time.



**Hardware I/O insert**

Insert paths require audio interface inputs and outputs, and are determined by the I/O Setup configuration of your system.

## General Information

When more than one insert is used on a track, they are processed in series. Each effect is added to that of any previous plug-ins or inserts, (flowing from top to bottom in the Mix window Inserts View, and left to right in the Edit window Inserts View).

Inserts on audio tracks and Auxiliary Inputs are pre-fader. You can cause clipping if you boost their gain to extremes, especially on tracks recorded at high amplitude. Watch on-screen metering for indication of clipping. (Inserts on Master Faders are post-fader.)

## How to Use Inserts for Effects Processing

Inserts can be used in two ways:

**On Single Tracks** An insert can be applied to an individual audio track, Auxiliary Input, or Master Fader.

With in-line inserts, you control the amount of effect by adjusting the balance (or, wet/dry) controls of the plug-in or external device.

**As Shared Resources** An insert can be used as a shared resource in a send-and-return arrangement, by bussing signals from several tracks to an Auxiliary Input, and then applying the insert to the Auxiliary Input track. You can then control the send level for each track, and the overall level of the effect can be controlled from the Auxiliary Input track. Using sends and other signal routing features helps maximize your system's processing power.

 For examples of send and return busses and other submixing setups, see “Submixing for Signal Routing and Effects Processing” on page 423.

## Insert Formats

**Mono Inserts** Used on mono tracks. Inserts that occur on a track after a stereo insert are automatically used in stereo as well.

**Stereo Inserts** Used on stereo tracks. A stereo hardware I/O insert sends the signal to an input/output path.

**Mono In/Stereo Out Plug-In Inserts** Used to return a stereo effect from a mono source. Certain plug-ins (such as D-Verb) let you generate stereo output from a mono channel. A track made into stereo in this way has pan controls for each channel of the stereo signal. Any inserts that occur on a track after a stereo insert are automatically used in stereo as well.

**Multi-Mono Plug-In Inserts** Used on stereo or greater-than-stereo multichannel tracks when a multichannel version of the plug-in is not available. Controls for all channels are linked by default so that you can adjust them in tandem. You can unlink controls for independent adjustment using the Master Link button. See “Linking and Unlinking Controls on Multi-Mono Plug-Ins” on page 443.

**Multichannel Plug-In Inserts** Used on stereo and greater-than-stereo multichannel tracks. On greater-than-stereo multichannel tracks, the controls for all channels are generally ganged together.

 *Relinking may cause automation to be lost. See “Linking and Unlinking Controls on Multi-Mono Plug-Ins” on page 443*

## TDM and RTAS Plug-Ins

There are three plug-in formats supported by Pro Tools (TDM, RTAS, and AudioSuite), two of which can be used as real-time inserts, as follows:

**TDM Plug-Ins** Used on TDM-based Pro Tools systems, and rely on the processing power of Digidesign DSP cards.

**RTAS Plug-Ins** Similar to their TDM counterparts, but unlike TDM plug-ins, they rely on and are limited by the host processing power of your computer.

 For information on AudioSuite plug-ins, see the *DigiRack Guide*, the *Digidesign Plug-Ins Guide*, or the guides for your third-party plug-ins.

Use the following guidelines for plug-ins supported on your system:

### Pro Tools TDM Systems

- TDM plug-ins can be used on audio tracks, Auxiliary Inputs, and Master Faders.
- RTAS plug-ins can be used on Auto-Voiced audio tracks only.
- When using RTAS and TDM plug-ins on the same track, RTAS plug-ins must precede TDM plug-ins in the insert signal path.

### Pro Tools LE Systems

- RTAS plug-ins can be used on audio tracks, Auxiliary Inputs, and Master Faders.

 For tips on maximizing RTAS performance, see the *DigiRack Plug-Ins Guide*.

## Viewing Inserts

Both the Mix and Edit windows can be configured to show or hide inserts. Plug-in windows provide complete access to plug-in controls.

### To show (or hide) inserts:

- In the Mix or Edit window, choose Display > Mix Window Shows > Inserts View, or Edit Window Shows > Inserts View.

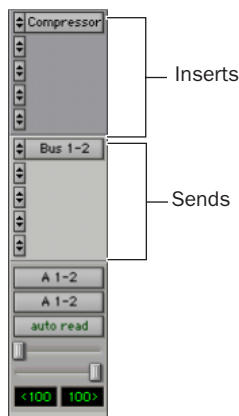

Showing Inserts in the Mix Window

– OR –

- In the Edit window, select Inserts View from the View Selector (located next to the Rulers View).



Showing Inserts using the View Selector

## Display of Plug-In Window Status

In the Mix and Edit window, the plug-in button and selector display the currently inserted plug-in, its bypass state (see “Bypassing Plug-Ins” on page 443), target status, and window status.

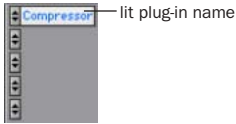

Indication of open plug-in window

## Indicating the Controller Target

If you are using a control surface with Pro Tools, only one plug-in can be targeted at a time. The current controller target, if any, is indicated with a color outline around its name:

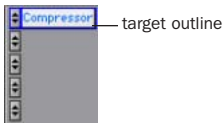

The controller target

 For more information on controller targets, refer to the *MIDI Control Surfaces Guide*, or the documentation for your Digidesign control surface.

## Making Inserts Inactive

Plug-in and hardware inserts can be made inactive to free up their resources for other uses. When a plug-in insert is inactive it retains its assignment, position, and related automation playlists. However, it will not pass audio and does not consume any DSP or TDM resources.

When opening sessions, inserts will automatically be made inactive in any of the following situations:

- The system has insufficient DSP resources.
- A plug-in is not installed.
- A plug-in type is not available (RTAS or TDM).
- Opening the session results in plug-in type substitutions. This can happen if the type is available but substituting would result in an unsupported condition, such as an RTAS plug-in after TDM plug-ins in a track.

### To make an insert inactive:

- Control-Start-click (Windows) or Command-Control-click (Macintosh) the Insert button.  
– or –
- Make the track inactive. See “Making Tracks Inactive” on page 102.

### To toggle inserts in the same position on all tracks active or inactive:

- Control-Start-Alt click (Windows) or Command-Control-Option click (Macintosh) an Insert button in the position you want to toggle.

### To toggle inserts in the same position on all selected tracks active or inactive:

- Control-Start-Alt-Shift-click (Windows) or Command-Control-Option-Shift-click (Macintosh) an Insert button in the position you want to toggle.

## Inactive Plug-In Inserts

Inactive plug-in inserts retain all associated automation playlists. In addition, any edits made in the session affect the plug-in automation playlists. You cannot record automation or adjust the controls for an inactive plug-in.

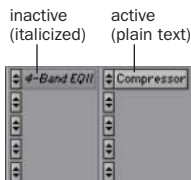

Display of inactive plug-ins (Pro Tools 6.x)



Display of inactive Plug-In window

## Inactive Hardware Inserts

Inactive hardware inserts retain their assignments, but do not pass audio and do not consume any DSP resources.

💡 *Hardware inserts do not provide a bypass control. You can use the inactive feature whenever you need to mute or bypass a hardware insert.*

## Inserting Plug-Ins on Tracks

To use a real-time plug-in, insert it on a track.

### To insert a plug-in on a track:

- 1 Make sure the Inserts View is shown in the Mix or Edit window.
- 2 Click the Insert Selector on the track and select the plug-in that you want to use. (See “TDM and RTAS Plug-Ins” on page 435 for related information.)

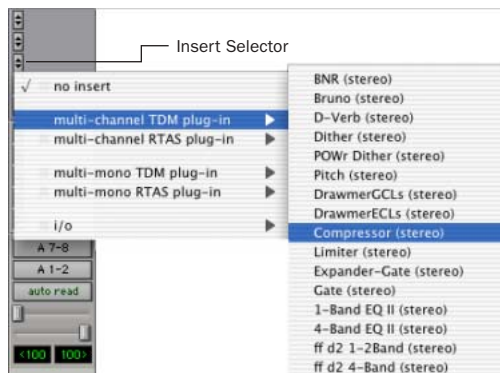

Inserting a TDM plug-in

### To remove an insert from a track:

- Click the Insert Selector and choose No Insert.

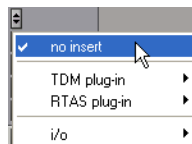

Removing a plug-in

## Plug-In Menu Organization

### (Pro Tools 6.4)

In Pro Tools 6.4, plug-ins are automatically organized by category (effect type). Plug-ins that do not fit into a standard category (such as the DigiRack Signal Generator), or third-party plug-ins that have not been defined by their developers, appear in the Other category. Plug-ins can appear in more than one category.

Plug in categories include:

- EQ
- Dynamics
- Pitch Shift
- Reverb
- Delay
- Modulation
- Harmonic
- Noise Reduction
- Dither
- Sound Field
- Hardware
- Instrument
- Other
- Wrapped Plug-Ins

## Plug-in Favorites

For faster navigation to commonly used plug-ins, a plug-in can be designated a *favorite*. Favorite plug-ins are shown at the top of the plug-in menu.

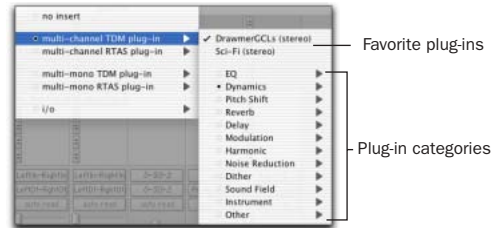

### Menu display of favorite plug-Ins

#### To designate a plug-in favorite:

- Control-click (Windows) or Command-click (Macintosh) on a plug-in Insert button, and select the plug-in that you want to designate as a favorite.

#### To remove a plug-in favorite:

- Control-click (Windows) or Command-click (Macintosh) on a plug-in Insert button, and select the favorite plug-in that you want to remove.

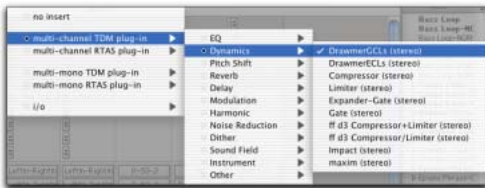

### Plug-Ins by Category

#### To organize plug-ins by category:

- 1 Choose Setups > Preferences.
- 2 Click on the Display tab.
- 3 Select Organize Plug-In Menus By Category.

## Inserting Plug-Ins During Playback

Plug-ins can be inserted or removed during playback, with the following restrictions:

- Plug-ins cannot be inserted or removed during recording.
- A plug-in cannot be dragged to a different insert location during playback or recording. Stop playback to do this.
- Plug-ins that change a track's format (a mono-to-stereo plug-in, for example) cannot be inserted or removed during playback. Stop playback to do this.
- Plug-ins that contain automation cannot be removed during playback. Stop playback to do this.
- Playback must be stopped when enabling plug-in controls for automation.
- Side-chain inputs cannot be created during playback. Stop playback to do this.

---

## Moving and Duplicating Plug-In and Hardware Inserts

You can move or duplicate an insert by dragging it to a different position on the same track or a different track. Inserts that are moved or duplicated retain their original settings and automation.

**⚠** *Plug-ins cannot be moved or duplicated during playback or recording.*

### To move an insert:

- Drag the insert to a new insert location.

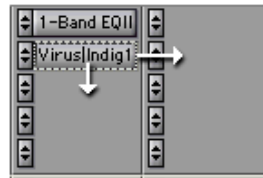

*Moving a plug-in*

**💡** *Dragging an insert on top of an existing insert will replace it and any automation.*

### To duplicate an insert:

- Alt-drag (Windows) or Option-drag (Macintosh) the insert to a new insert location. Duplicated plug-in inserts retain their original settings and automation.

## The Plug-In Window

The Plug-In window appears whenever you click a plug-in's Insert button on a track. This floating window lets you edit and adjust the controls of any real-time plug-in insert in use on a track.

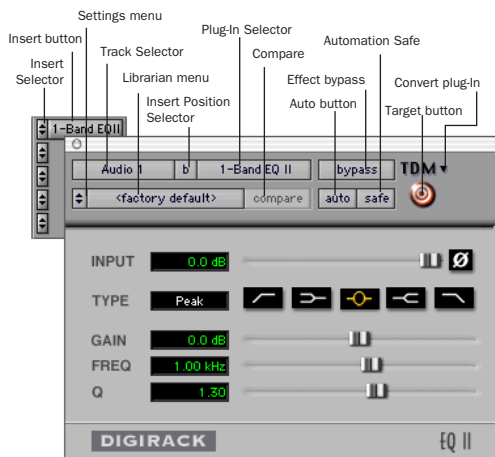

Plug-In window (mono 1-Band EQ shown)



Plug-In window (multi-mono 1-Band EQ shown)

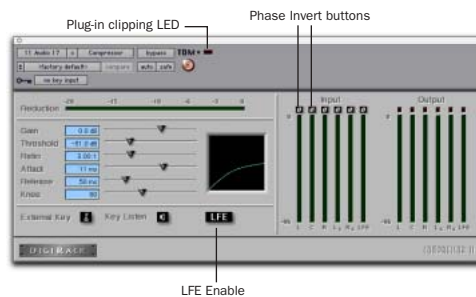

Plug-In window (multichannel Compressor shown)

**Settings Menu** Lets you copy, paste, save, and import plug-in settings.

**Track Selector** Accesses any non-MIDI track in your session.

**Librarian Menu** Recalls settings files saved in the plug-in's root settings folder or in the current session's Settings folder.

**Insert Position Selector** Accesses any insert on the current track.

**Key Input Selector** Lets you select audio on a particular input or bus and route it to trigger the plug-in. This menu only appears on plug-ins that feature side-chain processing. Key inputs are monophonic.

**Plug-In Selector** Lets you select any real-time plug-in installed in the DAE Plug-Ins folder.

**Compare** Toggles between the original saved plug-in setting and any changes you have made to it so you can compare them.

**Effect Bypass** Disables the currently displayed plug-in. This lets you compare the track with and without the effect.

**Auto** Lets you enable individual plug-in controls for automation recording. See "Automating Plug-Ins" on page 461.



**Safe** When enabled, prevents existing plug-in automation from being overwritten.

**Convert Plug-In** Lets you convert the insert from a TDM plug-in to an RTAS plug-in of the same type (or vice-versa). This feature can only be used on plug-ins that are available in both TDM and RTAS formats.

**Target Plug-In** When multiple Plug-In windows are open, clicking this button in a Plug-In window until it is lit, selects that plug-in as the target for any computer keyboard commands. Clicking the button until it is unlit leaves the window open when other Plug-Ins windows are opened. The target in the Plug-In window functions the same as the target in Output and Send windows. For more information, see “Targeted Windows” on page 422.

**Phase Invert** Inverts the phase polarity of the input signal.

**Plug-In Clip LED** In addition to clipping displays that are a part of a plug-in’s individual interface, plug-ins that display internal clipping also report the clipping in the plug-in header.



*Plug-In Clipping Indicator in the plug-In header*

**Channel Selector** Accesses a specific channel within a multichannel track for plug-in control editing. This menu appears only on multi-mono plug-ins inserted on tracks with more than one channel. Alt-click (Windows) or Option-click (Macintosh) this Selector to open a separate Plug-In window for each channel of the multichannel track on which the plug-in is inserted.

**Link Enable Buttons** Lets you selectively link the controls of specific channels of a multi-mono plug-in. Each square represents a plug-in output. The Master Link button must be disabled to use the Link Enable buttons. See “Linking and Unlinking Controls on Multi-Mono Plug-Ins” on page 443.

**LFE Enable** Enables plug-in processing of the LFE (low frequency effects) channel on a 5.1, 6.1, or 7.1 multichannel track. To disable LFE processing, deselect this button.

**Master Link Button** When enabled, links the controls on all channels of a multi-mono plug-in so that they can be adjusted in tandem.

## Opening Plug-In Windows

**To open a Plug-In window:**

- Click the plug-in button in the Mix or Edit window channel strip.

By default, each plug-in you open will appear in the same location as a currently open plug-in, replacing it in the same window location.

## Opening Multiple Plug-In Windows

Pro Tools normally displays a single Plug-In window from which you can adjust the controls of any session plug-in. You can also open additional Plug-In windows for specific plug-ins. Once you begin working with multiple Plug-In windows, you will need to click the Target button on the plug-in whose controls you want to adjust using keyboard commands.

**To open an additional Plug-In window:**

- In the Mix window, Shift-click the Insert button of a plug-in.

**To open Plug-In windows for each channel of a multi-mono plug-in:**

- Alt-click (Windows) or Option-click (Macintosh) the Channel Selector in the Plug-In window of a plug-in insert.

**To close all currently open Plug-In windows:**

- Alt-click (Windows) or Option-click (Macintosh) the close box of any currently open Plug-In window.

## Plug-In Window Controls

All plug-ins provide standard Pro Tools controls for track and insert selection, bypass, and other controls, in addition to the EQ, dynamics, and other processor-specific controls.

**To select a different plug-in on the same track:**

- Click the Insert Selector and select a plug-in from the pop-up menu.

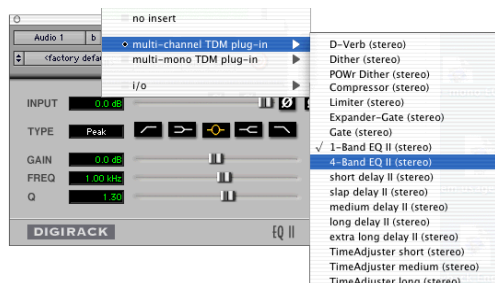

*Choosing a plug-in from the Plug-In window*

**To choose a different track:**

- Click the Track Selector and choose a track from the pop-up menu.

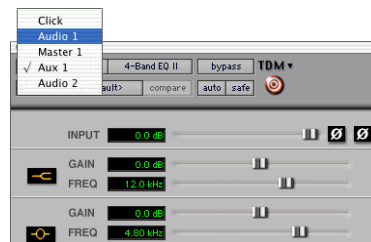

*Choosing a track from the Plug-In window*

## Target Window and Settings Shortcuts

When multiple Plug-In windows are open, a highlighted target indicates the target window. Pro Tools keeps a single plug-in target window. Opening a new plug-in opens it as the new target window, in the same location. In addition, the plug-in target window is also the focus of keyboard shortcuts for plug-in settings.

## Bypassing Plug-Ins

Plug-ins can be bypassed from their Plug-In window, or from the Mix and Edit window Inserts View.

 When a plug-in insert is bypassed, the Insert Selector in the Mix window changes its color to blue for easy visual reference. If some, but not all channels of an unlinked multi-mono plug-in are bypassed, the Insert Selector appears purple (Pro Tools 6.x) or half blue and half black (Pro Tools 5.x).

### To bypass a plug-in:

- Click the Plug-In window's Bypass button.
  - Or –
- Control-click (Windows) or Command-click (Macintosh) the plug-in's Insert button in the Mix or Edit window.

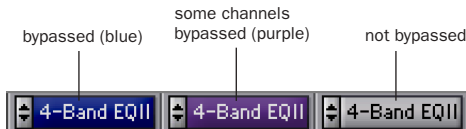

Indication of bypassed plug-in state (Pro Tools 6)

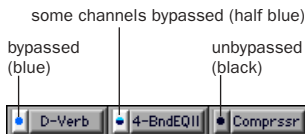

Indication of bypassed plug-in state (Pro Tools 5.x)

## Linking and Unlinking Controls on Multi-Mono Plug-Ins

### (TDM Systems Only)

When a multi-mono plug-in is used on a multi-channel track of more than two channels, the controls are normally linked. Adjusting the Gain control on one channel, for example, will adjust it for all channels.

You can unlink multi-mono plug-in controls on specific channels of a track and edit them independently. You can also selectively link the controls of specific channels.

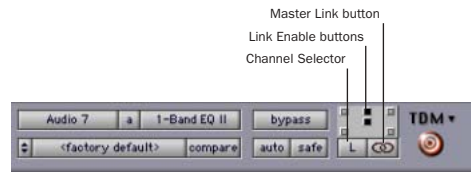

Channel Selector and Link controls (shown with Link disabled)

### To unlink controls on a multi-mono plug-in:

- Deselect the Master Link button.

### To access controls for a specific channel:

- Select the channel from the Channel Selector.

### To link the controls of specific channels:

- 1 Deselect the Master Link button if it is not already deselected.
- 2 Click the Link Enable buttons for the channels whose controls you want to link. For example, to link all channels except the LFE, highlight the icons representing the five full-range speakers in a multi-mono plug-in.

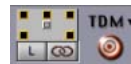

All channels linked except the LFE

---

## Editing Plug-In Controls

You can adjust plug-in controls by dragging the control's slider or knob, or by typing a value into the control's text box. For instructions on editing specific plug-ins, see the plug-in's documentation (such as the *DigiRack Plug-Ins Guide* and *Digidesign Plug-Ins Guide*).

### To adjust a plug-in control:

- 1 Begin audio playback so that you can hear the control changes in real time.
- 2 Adjust the controls of the plug-in for the effect you want.
- 3 Close the Plug-In window to save the most recent changes.

### Keyboard Shortcuts

- ◆ For finer adjustments, Control-drag (Windows) or Command-drag (Macintosh) the control.
- ◆ To return a control to its default value, Alt-click (Windows) or Option-click (Macintosh) the control.

## Keyboard Shortcuts for Plug-In Controls

You can use your computer keyboard to edit plug-in controls.

If multiple Plug-In windows are open, Tab and keyboard entry remain focused on the plug-in that is the Target window.

### To adjust controls from a computer keyboard:

- Click or Tab to the control text field that you want to edit to activate the field. Type an appropriate value.

- In fields that support values in kilohertz, typing “k” after a number value will multiply the value by 1,000. For example, type “8k” to enter a value of 8,000.
- To increase a value, press the Up Arrow on your keyboard. To decrease a value, press the Down Arrow on your keyboard.
- Press Enter on the numeric keyboard after typing a value to input the value (without leaving the selected control field).
- Press Enter on the alpha keyboard (Windows) or Return (Macintosh) to enter the value and leave keyboard editing mode.
- To move forward through the different control fields, press the Tab key. To move backward, press Shift+Tab.
- Press Alt-C (Windows) or Option-C (Macintosh) to clear plug-in clipping.



*The plug-in target window is the focus of keyboard shortcuts for plug-in settings. To make a plug-in the target for any computer keyboard commands (including key shortcuts), click the plug-in's Target button in its Plug-In window.*

## Plug-In Automation and Safe

All real-time plug-ins can be fully automated, and support all Pro Tools automation modes (Write, Touch, and Latch, plus Trim).

The Auto button opens the Plug-in Automation dialog, where you can enable individual plug-in controls for automation recording. (See “Automating Plug-Ins” on page 461 for more information.)

The Safe button engages Automation Safe mode. When enabled, existing plug-in automation is protected from being overwritten. (See “Record Safing Plug-In Automation” on page 462.)

## Using a Key Input for Side-Chain Processing

Some plug-ins (such as the DigiRack Compressor, Limiter, Gate, and Expander/Gate) feature side-chain processing capabilities. Side-chain processing allows you to trigger a plug-in from a separate reference track or external audio source. The source used for triggering is referred to as the *Key Input*. Key inputs are monophonic.

A typical use for this feature is to control the dynamics of one audio signal using the dynamics of another signal (the Key Input). For example, a kick drum track could be used to trigger gating of a bass track to tighten it up, or a rhythm guitar track could be used to gate a keyboard pad.

Another side-chain usage, is to create a tunable signal generator: Use a Signal Generator plug-in on an Auxiliary Input, add a gate plug-in to the track, then feed its gate with a side-chain from the kick. The generator is tunable (based on what tone you record).

**▲** *RTAS plug-ins do not provide side-chain processing when used on TDM-based systems; use the TDM versions of plug-ins on TDM-based systems if you want to use side-chain processing.*

### Key Input Filters

Some plug-ins feature key high pass and low pass filters. These controls allow you to define a specific frequency range in the Key Input signal with which to trigger the plug-in effect. A common production technique is to use these controls to filter a drum track so that only specific high frequencies (a hi-hat, for example) or low frequencies (a tom or a kick, for example) trigger the effect.

### To use a Key Input for side-chain processing:

**1** From the Key Input menu, choose the input or bus carrying the audio you want to use to trigger the plug-in.

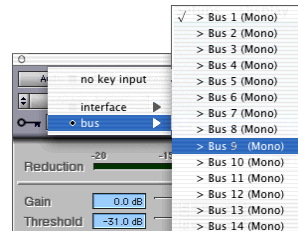

### Choosing a Key Input

**2** Click External Key to activate side-chain processing.

**3** To hear the audio source you have selected to control side-chain input, click Key Listen.

**4** To filter the Key Input so that only specific frequencies trigger the plug-in, use the Key HPF and Key LPF controls (if available) to select the frequency range.

**5** Begin playback. The plug-in uses the input or bus that you chose as a Key Input to trigger its effect.

**6** Adjust the plug-in's Threshold control (if available) to fine-tune Key Input triggering. Also experiment with the Send level, by feeding the side-chain more or less gain.

**7** Adjust other controls to achieve the desired effect.

---

## Using Hardware Inserts

You can connect external devices, such as reverb or effects processors, to your Pro Tools system and use them as inserts, or in a send-and-return arrangement.

Pro Tools inserts utilize corresponding hardware input and output channels to send and return the audio. Inserts can be defined, and their channels mapped to audio interface channels, in the I/O Setup dialog.

If you plan to use a device as an insert, be sure to connect the device to matching inputs and outputs on your system. For example, to use outputs 7–8, the insert has to use inputs 7–8. Routing the physical inputs and outputs of the interface to Pro Tools inputs and outputs can be done in the Hardware Setup dialog (or I/O Setup dialog). For more information, see “Configuring Pro Tools System Settings (in the Playback System Engine)” on page 37, or “Routing Hardware I/O to Pro Tools I/O” on page 71.

### To define a hardware insert:

- 1 Choose **Setups > I/O Setup**, then click the **Inserts** tab.
- 2 Select an insert path, or click **New Path** to create a new Insert path.
- 3 Double-click the **Path Name** to enter a custom path name for the insert.
- 4 Make sure the insert path is set to the correct format (mono, stereo, or other).
- 5 Map inserts in the **Channel Grid** as needed. Insert and Output paths have special rules regarding channel mapping (see “Overlapping Channels and Valid Paths” on page 77).

## Assigning Hardware Inserts

### To assign a hardware insert to a track:

- Select an insert from the track Insert Selector.

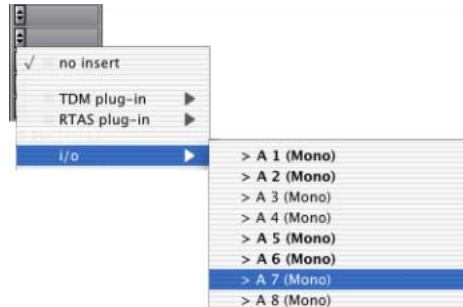

Selecting a hardware I/O insert

## Bypassing Hardware Inserts

Hardware inserts do not provide a bypass control. To monitor playback without a hardware insert, either set it to **Inactive**, remove it by reassigning it to **No Insert**, or use a bypass switch on the hardware device itself.

See “Making Inserts Inactive” on page 436 for more information.

---

## Connecting and Integrating External Devices

Pro Tools TDM and LE systems can create dedicated connections to external analog or digital devices. The number and type of connections depends on what kind of system you have.

### To connect an external device to a Pro Tools system:

- 1 Connect an unused output (or pair of outputs for a stereo device) of your Pro Tools system to an input of the external signal processor.
- 2 Connect the output of the external signal processor to an unused input (or pair of inputs for a stereo device) of your Pro Tools system.
- 3 Define what physical ports are routed to Pro Tools input and output ports, as appropriate, in either the Hardware Setup dialog or I/O Setup dialog.
- 4 Define output, input, or insert paths as appropriate in the I/O Setup dialog.

If you plan to use a device as an insert, be sure to connect the device to matching inputs and outputs on your system. For example, to use outputs 7–8, the insert has to use inputs 7–8 also.

 For additional information on connecting external devices, refer to your Pro Tools Getting Started Guide.

## Connecting Effects Units Digitally

If you want to use the digital inputs and outputs on your Pro Tools system as effects sends and returns to a digital effects device, Pro Tools should be the clock master in most cases. Set your digital effects device to accept an external digital clock so that it synchronizes to Pro Tools.

### To set up a digital send to an external device from a TDM system:

- 1 Do one of the following:
  - On a 192 I/O, 192 Digital I/O, 96 I/O, 96i I/O, or 888|24 I/O in an HD-series system, choose Setups > Hardware Setup, choose the peripheral, and set the channel pair to Digital.
  - On an 888|24 I/O that is used on a MIX-series system, choose Setups > Hardware, choose the peripheral, click Other Options, and set the channel pair to Digital.
  - On an 882|20 I/O or 1622 I/O, choose Setups > Hardware Setup, choose the peripheral, and set Channel 1–2 input to Digital.
- 2 Choose Internal from the Clock Source pop-up menu (Pro Tools 5.3 and higher) or Sync Mode pop-up menu (Pro Tools 5.2 and lower).
- 3 Click OK.

**To set up a digital send to an external device from a Digi 002, Digi 002 Rack, or Digi 001 system:**

- 1 Choose Setups > Playback Engine and choose the peripheral.
- 2 Do one of the following:
  - If the external device is connected to the S/PDIF RCA jacks, deselect S/PDIF Mirroring. (When S/PDIF Mirroring is on, digital output at the S/PDIF RCA jacks exactly mirrors the output of analog Channels 1–2.)
  - If the external device is connected to the Optical ports, choose a format (most likely S/PDIF for an effects device) from the Optical Format pop-up menu.
- 3 Choose Internal from the Clock Source pop-up menu.
- 4 Click OK.
- 5 Optionally, configure the I/O Setup dialog with new path names for effects routing.

 *If you set the Optical Format to S/PDIF, Pro Tools will watch the Optical port for any audio input, and ignore any audio input on the S/PDIF RCA jacks.*

## Using External Clock Sources

All Pro Tools systems can synchronize to an external clock source. Options for external clock vary according to the type of Pro Tools system you are using.

### TDM Systems

Pro Tools|HD systems can receive external clock through any of the digital inputs on any HD-series I/O (including AES/EBU, S/PDIF, and Optical).

With Pro Tools|24 MIX-series systems, or if an expanded Pro Tools|HD system includes Legacy interfaces (such as the 888|24 I/O), connect to the digital input on Channels 1–2 of the Legacy audio interface in order to clock from them. Legacy I/Os only support 44.1 kHz and 48 kHz sample rates.

 *To determine correct card order and audio interface connections for TDM systems, refer to the Getting Started Guide that came with your system.*

**To select an external clock source for a TDM system:**

- 1 Choose Setups > Hardware Setup.
- 2 Select the appropriate HD I/O in order to display its settings in the Main page.
- 3 If necessary, enable the appropriate Digital Format (if you have not already done so, according to the instructions in your *Getting Started Guide* or *I/O Guide*).
- 4 Set the Clock Source (Pro Tools 5.3 and higher) or Sync Mode (Pro Tools 5.2 and lower) to match the type of input.
- 5 Configure input routing of the digital source, using the Input and Output pop-up menus, if necessary.



6 Click OK to close Hardware Setup.

### **Digi 002, Digi 002 Rack, and Digi 001 Systems**

Pro Tools can receive external clock from the Optical input or S/PDIF input.

#### **To select an external clock source for a Digi 002, Digi 002 Rack, or Digi 001 system:**

- 1 Choose Setups > Hardware Setup.
- 2 Set the Clock Source (Pro Tools 5.3 and higher) or Sync Mode (Pro Tools 5.2 and lower) to match the type of input.

If you choose Optical, make sure the Optical Format matches the type of optical input you are sending to your Pro Tools system.

 *If you set the Optical Format to S/PDIF, Pro Tools will watch the Optical port for external clock, and ignore any clock input on the S/PDIF RCA jacks.*

### **Mbox Systems**

Pro Tools can receive external clock from the S/PDIF input on the Mbox.

#### **To select an external clock source for an Mbox system:**

- 1 Choose Setups > Hardware Setup.
- 2 Choose the SPDIF (Windows) or SPDIF/RCA (Macintosh) from the Clock Source pop-up menu.
- 3 Click OK

 *Your digital input device must be connected and powered on for Pro Tools to synchronize to it. If your input device is not powered on, leave the Clock Source set to Internal.*



# Chapter 28: Automation

Pro Tools features dynamic automation of volume, pan, and mute controls for audio tracks and sends, MIDI tracks, and real-time plug-in controls. In Pro Tools, you can write automation moves in real time during playback of your session. You can also edit automation data with the same techniques you use to edit audio and MIDI data.

## Automation Accuracy with Control Surfaces

**D-Control, ProControl and Control|24** Digidesign's D-Control, ProControl and Control|24 control surfaces support all automation features in Pro Tools. Digidesign control surfaces provide 10-bit resolution, or 1,024 steps of fader resolution. Pro Tools interpolates this input to 24-bit resolution on playback, resulting in extremely accurate and smooth fader automation.

 *For details on using Digidesign control surfaces to create mix automation, refer to your Digidesign control surface guide.*

**MIDI Control Surfaces** Most MIDI control surfaces have 8-bit resolution, or 128 steps. Pro Tools interpolates this input to 24-bit resolution on playback, resulting in extremely accurate and smooth fader automation.

 *For details on using MIDI control surfaces to create mix automation, refer to the MIDI Control Surfaces Guide.*

---

## Automation Quick Start

Pro Tools provides many options for recording, replacing, and editing automation data.

The basic steps for automation recording are:

- Enable the automation type that you want to record (volume, pan, mute, send level, send pan, send mute, or plug-in automation).
- Put the appropriate tracks in an automation writing mode (Write, Touch, or Latch, or a Trim mode).
- If you are automating a plug-in, enable the individual plug-in controls to be automated.
- Automation Safe any plug-ins, outputs, or sends that have existing automation data that you want to protect from being overwritten.
- Begin playback to begin automation recording, and adjust controls as needed. Pro Tools remembers all moves performed on enabled controls.

To edit automation once it has been recorded, you can:

- Repeat the above steps to write new automation over the previous data.
- Graphically edit the automation data in the Edit window.
- Cut, copy, paste, or delete automation data (certain restrictions apply).

---

## Automation Playlists

Each Pro Tools track contains a single automation playlist for each automatable parameter.

On audio tracks, these parameters include:

- Volume
- Pan
- Mute
- Send volume, pan, and mute
- Plug-in controls

On MIDI tracks, these parameters include:

- Volume
- Pan
- Mute

You can display and edit each of these automatable playlists individually from Pro Tools, even during playback.

In addition, you can display and edit other continuous MIDI controller data (such as mod wheel, breath controller, foot controller, or sustain) in a similar manner. For more information on editing MIDI data, see “Continuous Controller Events” on page 364.

## Automation Playlists with Audio and MIDI Regions

Pro Tools handles audio regions and their automation playlists differently from MIDI regions and their automation playlists.

### Audio Tracks

On audio tracks, automation data resides on a separate playlist from audio data and regions. Each edit playlist on an audio track shares the same automation data.

### MIDI Tracks

On MIDI tracks, all controller automation data *except for Mute data* is stored in the MIDI region that contains it. Each edit playlist on a MIDI track is separate, and represents a distinct performance, complete with controller automation.

**▲** *Mute data is independent of the MIDI data in a MIDI region. This lets you mute playback of individual MIDI tracks in Pro Tools without altering the controller data.*

### Multiple Edit Playlists and Audio Track Automation

All edit playlists on a single audio track share the same automation data. When you record or edit automation data in an audio track, the automation data is stored in the track automation playlist so it can be edited with, or independently

from, its associated audio regions. (MIDI automation data always follows region editing, with the exception of mute. See “MIDI Tracks” on page 452 for more information.)

- ◆ When you copy or cut audio data from a track while it is in Waveform View, the underlying automation data is cut or copied with it.
- ◆ If you paste audio data from other locations or tracks into an edit playlist, you may change the underlying automation data on the track.
- ◆ When you trim regions using Edit > Trim, the underlying automation data remains unchanged.

 For more information, see “Editing Automation” on page 467.

### Duplicating Tracks for Playlist Editing

The Duplicate Selected Track command provides a convenient way to make a working copy of a track to experiment with routing, plug-ins, and automation. This protects the original track and its automation data from being edited or overwritten.

#### To copy a track for automation:

- 1 Select the track and choose File > Duplicate Track. Duplicate Track creates a complete copy of the track, including all routing, plug-ins, and automation.
- 2 Command-Control-click the Track Type icon, or select that track and choose File > Make Selected Tracks Inactive.
- 3 Edit automation on the duplicated track.

---

## Automation Modes

Each track provides an Automation Mode Selector. Automation modes control how a track’s automation data is written and played back.

### Auto Off

Auto Off mode turns off automation for all automatable parameters:

- Volume
- Pan
- Mute
- Send volume, pan, and mute
- Plug-in controls
- MIDI volume, pan, and mute

In Auto Off mode, automation data for these parameters is ignored during playback. All other MIDI controller data is sent.

### Auto Read

Auto Read mode plays the automation that was previously written for a track.

### Auto Write

Auto Write mode writes automation from the time playback starts to the time it stops, erasing any previously written automation for the duration of the automation pass.

After an automation pass, Pro Tools automatically switches from Auto Write mode to Auto Touch mode. This prevents you from accidentally overwriting automation data on later playback. On TDM systems, you can turn off this behavior and remain in Auto Write mode. See “Write Switches To Touch After Pass” on page 61 for details.

## Auto Touch

Auto Touch mode writes automation only while a fader or switch is touched or clicked with the mouse. When the fader is released, the writing of automation stops and the fader returns to any previously automated position, at a rate determined by the AutoMatch and Touch Timeout settings. See “Automation Preferences” on page 456.

In Auto Touch mode, certain control surfaces start writing automation as soon as you touch them. These include:

- Touch-sensitive motorized fader controllers, such as Digidesign’s D-Control, ProControl, Control|24, Digi 002, Command|8, or the Mackie HUI.

With other control surfaces in Auto Touch mode, writing of automation does not begin until the fader hits the *pass-through point*, or the previously automated position. Once you reach the pass-through point with the fader, or a non-touch sensitive rotary control, writing of automation begins and continues until you stop moving the fader.

## Auto Latch

Auto Latch mode works in the same way as Auto Touch mode, writing automation only if you touch or move a control. However, unlike Auto Touch, writing of automation continues until you stop playback or “punch out” of the automation pass by changing the automation mode to Read or Touch. Auto Latch mode is particularly useful for automating pan controls and plug-ins on non-touch sensitive rotary controls, since it does not time out and revert to its previous position when you release a control.

 See also “Writing Automation to the Start, End or All of a Selection” on page 473.

## Trim Mode

### (TDM Systems Only)

Pro Tools TDM systems can adjust (or *trim*) existing track volume and send level automation data in real time. Pan and plug-in automation cannot be trimmed in this manner. Trim mode works in combination with the other Automation modes (Auto Read, Auto Touch, Auto Latch, Auto Write) and is useful when you want to preserve all of your volume automation moves, but need to make levels a bit louder or softer to balance a mix.

When editing automation in Trim mode, fader moves write *relative* rather than *absolute* values. The existing automation data is changed by the amount of increase or decrease (or the *delta* value) indicated by the faders. When trimming, a track’s Volume indicator or Send Level indicator shows the delta values being written rather than the absolute value.

When Trim mode is enabled, *non-trimmable* controls behave in the same manner as in the standard Automation modes, with the exception of Trim/Auto Write mode, where non-trimmable controls operate as in Auto Touch mode.

### Trim/Auto Off

Trim/Auto Off mode turns off automation and trimming for a track. All automation moves are suspended during playback.

### Trim/Auto Read

In Trim/Auto Read mode, volume and send faders follow the previously written automation. When one of the faders is touched, the trim moves (delta values) are played back, but are not written into the automation data. This lets you audition trim moves without affecting existing automation.

When this mode is enabled, non-trimmable controls (all controls other than track volume and send level) behave as if they are in regular Auto Read mode—no automation data is written.

### **Trim/Auto Touch**

In Trim/Auto Touch mode, when playback begins, volume and send faders follow the previously written automation. When one of the faders is touched, real-time trimming begins. Fader moves write delta values (an increase or decrease in the form of an offset to existing automation data).

When the fader is released, trimming stops and the fader returns to a zero delta or offset value and continues to follow the previously written automation. The rate of the fader's return to a zero delta value is determined by the AutoMatch Time specified in the Automation Preferences. See "Automation Preferences" on page 456 for more information.

When this mode is enabled, non-trimmable controls (all controls other than track volume and send level) behave as if they are in regular Auto Touch mode—they follow the previously written automation until touched. When they are touched, their absolute positions are written until the control is released or until playback stops.

### **Trim/Auto Latch**

In Trim/Auto Latch mode, when playback begins, volume and send faders follow the previously written automation. When one of the faders is touched, real-time trimming begins. Any fader moves after trimming begins increase or decrease existing automation data accordingly.

Trimming of the touched control continues until playback stops, or until you "punch out" of the record pass by changing the automation mode to Read or Touch.

When this mode is enabled, non-trimmable controls (all controls other than track volume and send level) behave as if they are in regular Auto Latch mode—they follow the previously written automation until touched. When they are touched, their absolute positions are written until playback is stopped.

### **Trim/Auto Write**

In Trim/Auto Write mode, the volume and send level faders are disengaged from displaying the existing automation data, so you don't have to chase them during playback. Faders are automatically positioned at 0 dB, where no trimming occurs (they start with a delta value of zero). From this reference point you can then set the initial delta values before initiating playback.

In this mode, as soon as playback begins, delta values are applied to the existing automation data. Trimming continues until playback stops.

When Trim/Auto Write mode is enabled, non-trimmable controls (all controls other than track volume and send level) are not in Write mode, but behave as if they are in *regular Auto Touch mode* (no automation is written unless a control is touched). This is to prevent the controls from overwriting all of their automation data on every pass in Trim mode.

**⚠** *In Trim mode, tracks do not automatically change from Trim/Auto Write to Trim/Auto Touch after an automation pass. Be sure to switch out of Auto Write when you leave Trim mode to avoid overwriting automation data.*

## Automation Preferences

Pro Tools gives you several options for controlling the writing and playback of automation data.

### To display Automation Preferences:

- Choose Setups > Preferences, and click Automation.

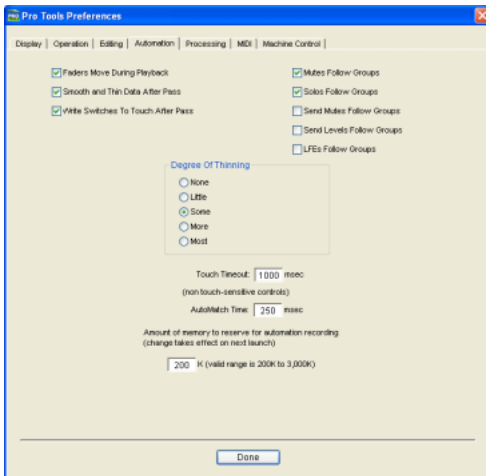

Automation Preferences dialog

 For detailed information on Pro Tools Automation Preferences, see “Automation Preferences” on page 61.

## Smoothing

When you perform automation moves with a continuous control, Pro Tools records the move as a series of very small steps, resulting in a staircase pattern with many breakpoints. Smoothing intelligently resolves this staircase pattern into a single, smooth ramp from one breakpoint to the next. (Smoothing does not apply to switched controls such as mutes or plug-in bypasses.) With smoothing enabled, the resulting automation is often a more accurate representation of actual automation moves.

## Thinning

Thinning automatically reduces the overall number of breakpoints in the automation playlist in order to improve system performance. The amount of thinning applied is determined by the Degree of Thinning setting in the Automation Preferences. When using high amounts of thinning, the resulting automation may differ noticeably from the original automation moves. Thinning only applies to audio tracks, and does not affect MIDI tracks. For instructions, see “Thinning Automation” on page 465.

## AutoMatch

When you write automation in Auto Touch mode, if you release a fader during playback, Pro Tools returns to the level of any automation still on the track by ramping up or down over a certain amount of time, called the *AutoMatch Time*. This time value is set in the Automation Preferences.

The AutoMatch feature works with continuous controls (such as Volume or Pan) by ramping their values back to previously automated levels. There are some stepped controls (for example,



the EQ type in the 1-band EQ plug-in) that provide more than two discrete steps over their operational range. AutoMatch has no effect on these controls.

### AutoMatch Indicators

There are triangular AutoMatch indicators at the bottom left of each channel strip in the Mix window. When lit, these indicate the direction you need to move a fader in order to match the original automation level of that fader.



Triangular AutoMatch indicators on a channel strip

### Setting the Automation Buffer Size

Pro Tools lets you specify the size of the memory buffer used to write automation. If you are working on a large session or writing a very large number of automation moves, you may want to increase this value.

#### To set the Automation Buffer size:

- 1 Choose Setups > Preferences and click Automation.
- 2 For the option “Amount of memory to reserve for automation recording,” enter a value between 200 and 20,000K (Pro Tools 6.4) or between 200 and 3000K (Pro Tools 6.3 and below). The default value for a new session is 200K.
- 3 Relaunch Pro Tools for this change to take effect.

### About Processing Bandwidth

Meters in the System Usage window indicate how much of your system’s processing power is being used in processing audio, and when writing and playing back automation. In Pro Tools LE, these meters show System Activity and CPU Processing Activity; on Pro Tools TDM systems, they show System Activity, PCI Bus Activity, CPU Processing Activity, Disk Activity (Pro Tools 6.x only), and TDM Time Slot usage.

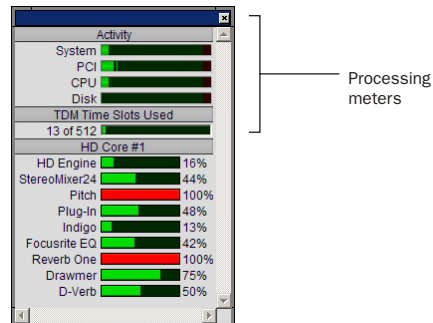

Meters in the System Usage window (TDM shown)

As these meters approach their limits, recording or playback of automation data may be affected.

If CPU or PCI Activity are high, a System error may occur. If System Activity is high, Pro Tools may miss playback of some of your automation data during particularly dense periods of activity, such as while using the Bounce to Disk command.

 For more information, see “Bounce to Disk” on page 482.

### To reduce processing load, try the following:

- Deselect the Faders Move During Playback option in the Automation Preferences.
  - or –
- Reduce the density of automation in places where it shows the most activity. For details, see “Thinning Automation” on page 465.
  - or –
- Turn off Sends View meters, if enabled, in the Preferences > Display window. See “Sends View Meters” on page 417 for more information.

## Automation Safe

Outputs, sends, and plug-ins can be placed in Auto Safe mode. In Auto Safe mode, any automation associated with an Output window (such as track or send level, panning, or mute), or plug-in on that track, is protected from being overwritten while automating other items on that track.



**Automation Safe enabled send**

Automation Safe mode suspends automation recording for the selected track output, send, or plug-in that is enabled. You can also suspend automation recording and playback session-wide from the Automation Enable window. See “Enabling and Suspending Automation” on page 463.

## Viewing Automation

Pro Tools creates a separate playlist for each type of automation you write. This data can be viewed and edited in the same way as audio and MIDI data.

### To show automation data:

- Click the Track View Selector and select from the pop-up menu the automation type you want to view.



### Displaying automation data

 You can easily toggle between Volume and Waveform View for audio tracks. For more information, see “Toggling Track Views” on page 210.

## Writing Automation

You can write automation for all automatable controls by moving those controls during playback.

### To write automation on a track:

- 1 Choose Windows > Automation Enable.
- 2 Make sure the automation type is write-enabled.

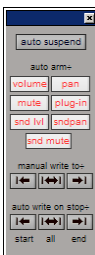

### Automation Enable window

3 From the Automation Mode pop-up menu, select an Automation mode for each track you want to automate. For the initial automation pass, select Auto Write.

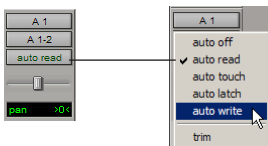

### Choosing an Automation mode

- 4 Click Play to begin writing automation.
- 5 Move the controls you want to automate.
- 6 When you have finished, click Stop.

After the first automation pass, you can write additional automation to the track without completely erasing the previous pass by choosing Auto Touch mode or Auto Latch mode. These modes add new automation only when you actually move the control. (See “Automation Modes” on page 453.)

### To write additional automation to a previous pass:

- 1 Enable Operations > Link Edit and Timeline Selection.
- 2 In the Edit window, make a selection or place the cursor in the location where you want to start writing automation.
- 3 From the Automation Mode pop-up menu, select Auto Touch or Auto Latch mode for the tracks you want to automate.
- 4 Click Play to begin writing automation.
- 5 Move the controls you want to automate.
- 6 When you have finished, click Stop.

 *If you write automation in Auto Touch mode with Loop Playback enabled, writing of automation will automatically stop at the end of the looped selection. At the beginning of each successive loop, you can then touch or move the control again to write new data.*

## Storing an Initial Controller Position

When you create a new audio track, Auxiliary Input, or MIDI track, it is automatically placed into Auto Read mode. Even though the track is in Auto Read mode, you can set the initial position of any automatable control, and it is saved with your session.

In this initial state, only a single automation breakpoint appears at the beginning of each automation playlist. If you move the control without writing automation, this breakpoint will move to the new value.

You can permanently store the initial position of an automatable control by doing one of the following:

- Place the track in Auto Write mode and press Play to write a few seconds of automation data to the track
- Manually place a breakpoint on the automation playlist somewhere after the initial breakpoint. (See “Graphical Editing of Automation Data” on page 467 for more information.)

## Automating Switched Controls

Pro Tools treats switched controls (such as mutes and plug-in bypasses) as touch sensitive controls. Automation data is written for as long as the switch or button for that control is pressed or touched.

For example, if you have just written a series of mute on/off states on a track in quick succession, the manual method for clearing this automation data would require you to move to the Edit window, choose automation playlist for Mute, select the mute automation data, and delete it.

In Pro Tools, it is not necessary to perform all of these steps. Instead, perform another automation pass on the track and hold down the Mute button when it reaches the state you want to remove. For example, when playback gets to the first muted section, the Mute button become highlighted. At this time, press and hold down the Mute button. As long as the button is held down, Pro Tools overwrites the underlying mute data on the track with the *current state* of the switch (on or off) until playback is stopped.

## Automating Sends

Pro Tools provides automation of send level, send mute, and send pan (for stereo and multi-channel sends only). This makes it easy to control effects levels and placement during mix-down with great precision.

Send level and mute can also be configured to follow groups.

### To automate a send level, mute or pan:

- 1 In the Automation Enable window, make sure the automation type is write-enabled (send level, send mute, send pan).
- 2 Choose an Automation mode for each track you want to automate. For the initial automation pass, choose Auto Write.
- 3 To display send controls, do any of the following:
  - Select Windows > Mix Window Shows > Sends View, then click the send to open the Output window for the send that you want to automate.
  - Choose Display > Sends View Shows and select the individual send from the submenu.
- 4 Click Play to begin writing automation.
- 5 Move the controls you want to automate.
- 6 When you have finished, click Stop.



*Send mutes and levels can also be configured to follow Mix Groups. See “Automation Preferences” on page 456 for information.*

## Copying Track Automation to Sends

### (TDM Systems Only)

There may be times where you want a track's send automation to mirror automation in the track itself, for example, when an effect level needs to follow the levels in a main mix. To do this, you can copy the entire automation playlist for the selected control to the corresponding playlist for the send.

#### To copy a track's automation to one of its sends:

- 1 Select the tracks you want to edit by clicking on the track names to highlight them.
- 2 Choose Edit > Copy To Send.

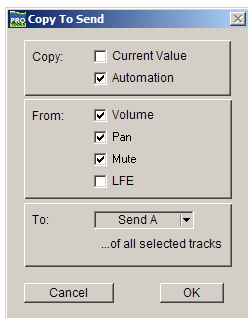

*Copy To Send dialog*

- 3 In the Copy to Send dialog, select Automation to copy the entire automation playlist for the corresponding controls.

- 4 Select the controls you want to copy.

- 5 Select the sends to which to copy the automation, and click OK.



*When overwriting automation, Pro Tools presents a confirmation dialog. To suppress this dialog, press Alt (Windows) or Option (Macintosh) while clicking OK.*

You can undo the results of the Copy to Send command (Edit > Undo).

## Automating Plug-Ins

You can automate changes to virtually all controls of the plug-ins included with your Pro Tools system. Automating a plug-in is slightly different from other automation procedures, because you must enable individual plug-in controls for automation.

#### To enable plug-in controls for automation:

- 1 Open the Plug-In window for the plug-in you want to automate.

2 Click the Automation Enable button in the Plug-In window.

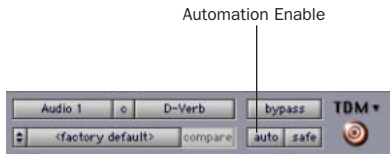

Accessing the Plug-In Automation dialog

– or –

Control-Alt-Start-click (Windows) or Command-Option-Control-click the Track View Selector in the Edit window.

 You can also use this keyboard shortcut to open the Plug-In Automation dialog: Control-Alt-Start-click (Windows) or Command-Option-Control-click (Macintosh) any plug-in parameter in the Plug-In window, then choose Open Plug-In Automation Dialog from the pop-up menu.

3 Choose the controls to automate and click Add. If there are multiple plug-ins on the same track, you can select from among these by clicking their buttons in the Inserts section of this dialog.

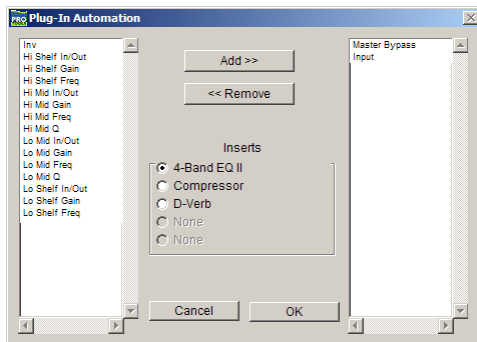

Plug-In automation dialog

4 Click OK to close the Plug-In Automation dialog.

 As an alternative to using the Plug-In Automation window, you can enable individual plug-in controls directly from the Plug-In window by Control-Alt-Start-clicking (Windows) or Command-Option-Control-clicking (Macintosh) the control. Refer to the DigiRack Plug-Ins Guide or Digidesign Plug-Ins Guide for more information.

### To automate a plug-in:

- 1 In the Automation Enable window, make sure plug-in automation is enabled.
- 2 Select an Automation mode for each track containing plug-ins you want to automate. For the initial automation pass, choose Auto Write.
- 3 Click Play to begin writing automation, and move the controls you want to automate.
- 4 When you have finished, click Stop.

### Record Safing Plug-In Automation

You can protect plug-in automation from being overwritten by using Automation Safe mode.

#### To enable plug-in safe mode:

- 1 Open a plug-in.
- 2 Click the Safe button so that it is highlighted.



Automation Safe enabled plug-in

---

## Enabling and Suspending Automation

From the Automation Enable window, you can enable or suspend writing for the following types of automation across all tracks:

- Volume
- Pan
- Mute
- Plug-in
- Send level
- Send pan
- Send mute

### To suspend writing of automation on all tracks:

1 Choose Windows > Show Automation Enable.

2 Do one of the following:

- To suspend writing of all automation on all tracks, click the Auto Suspend button.
- To suspend writing of a specific type of automation on all tracks, click the button for that automation type (volume, mute, pan, plug-in, send level, send mute, or send pan).



Automation Enable window

## Suspending Automation Playback

You can suspend playback of automation for tracks by clicking on the track's View Selector.

### To suspend playback (and writing) of automation for specific controls:

1 In the Edit window, set the Track View Selector to show the automation playlist for the control you want to suspend.

2 Do one of the following:

- To suspend writing and playback of automation for only the displayed control, Control-click (Windows) or Command-click (Macintosh) the control name in the Track View Selector.
- To suspend writing and playback of automation for all controls, Control-Shift-click (Windows) or Command-Shift-click (Macintosh) the name of any control in the Track View Selector.
- To suspend writing and playback of automation for a specific control on all tracks, Control-Alt-click (Windows) or Command-Option-click (Macintosh) the name of the control in the Track View Selector.

**A** *Enabling and suspending automation from the Edit window obeys Edit Groups (except for Pan automation). This grouped behavior can be suppressed by Start-clicking (Windows) or Control-clicking (Macintosh) the control name.*

## Automation Enable Guidelines

The following rules determine whether automation is written or played back for a track:

- ◆ Although Pro Tools shows a single Automation mode for each track, all automatable controls associated with that track are not necessarily in the same Automation mode.
- ◆ If automation is globally suspended in the Automation Enable window, all automatable controls behave as if they were in Auto Off mode, regardless of the track's current Automation mode.
- ◆ If automation for a control is suspended by Command-clicking (Macintosh) or Control-clicking its name in the Track View Selector, that control behaves as if it were in Auto Off mode, regardless of the track's current Automation mode.
- ◆ If automation for a control is suspended in the Automation Enable window, that control behaves as if it is in Auto Read mode when the track is in a recordable Automation mode (Auto Touch, Auto Latch, or Auto Write mode).

---

## Deleting Automation

Automation data takes the form of a line graph with editable breakpoints. The easiest way to remove automation in a track or selection is to manually delete breakpoints from the automation playlist.

Removing data in this manner is different from using the Cut command, which creates anchor breakpoints at the boundaries of the remaining data. For details, see “Cutting, Copying, and Pasting Automation” on page 471.

To remove automation data, display the automation playlist you want to edit by selecting it from the Track View Selector, and do one of the following:

### To remove a single breakpoint:

- With the Grabber or the Pencil Tool, Alt-click (Windows) or Option-click (Macintosh) the breakpoint.

### To remove several breakpoints at once:

- Use the Selector to select a range that contains the breakpoints, and press Backspace (Windows) or Delete (Macintosh).

### To remove all automation data of the displayed type:

- Click with the Selector in the track and choose Edit > Select All, then press Backspace (Windows) or Delete (Macintosh).

### To remove all automation for all automation playlists on a track:

- 1 Use the Selector to select a range of data to be removed.
- 2 Press Control+Backspace (Windows) or Control+Delete (Macintosh).

All automation data within the selection is removed for *all* automation playlists on that track, regardless of whether automation is write-enabled for those controls.



---

## Thinning Automation

Pro Tools writes a maximum density of automation data during an automation pass, in the form of breakpoints. Since Pro Tools creates ramps between breakpoints, it may not need all of the captured points to create a sonically accurate representation of the automation moves that you have made. Each breakpoint takes up space in memory allocated for automation, so thinning data can maximize efficiency and CPU performance.

Pro Tools provides two different ways to thin automation data and remove unneeded breakpoints: the Smooth and Thin Data After Pass option and the Thin Automation command.

### Using Smooth and Thin Data After Pass

When this option is selected in Setups > Preferences > Automation, Pro Tools automatically thins the automation breakpoint data after each automation pass.

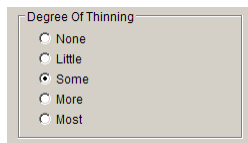

#### *The Smooth and Thin Data After Pass Option*

In the default settings for new sessions, the Smooth and Thin Data After Pass option is selected, with the “Some” setting chosen. In most cases, this setting yields optimum performance while providing an accurate reproduction of your automation moves.

If you choose None, Pro Tools writes the maximum possible number of breakpoints. You can still perform thinning at any time with the Thin Automation command (Edit > Thin Automation). For more information on smoothing automation data, see “Smoothing” on page 456.

## Using the Thin Automation Command

The Thin Automation command lets you selectively thin areas in a track where automation data is too dense. You can use the Undo command to audition the results of thinning (comparing thinning and not thinning) before you apply it permanently.

### To use the Thin Automation command:

- 1 In the Edit window, click the Track View Selector to display the automation type you want to thin.
- 2 With the Selector, highlight the automation data you want to thin. To thin all automation of the selected type in the track, click the Selector in the track and choose the Select All command.
- 3 Choose Edit > Thin Automation to thin the selected automation by the amount you have selected in the Automation Preferences.

---

## Drawing Automation

Use the Pencil tool to create automation events for audio and MIDI tracks by drawing in any automation or MIDI controller playlist.

The Pencil tool can be set to draw a series of automation events with the following shapes:

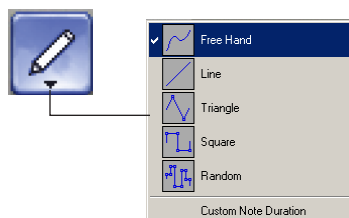

#### *Choosing a Pencil tool shape*

**Free Hand** Draws freely according to the movement of the mouse. In audio tracks, the shape has the number of breakpoints needed to smoothly interpolate and reproduce the automation shape. In MIDI tracks, the shape is reproduced as a series of steps, according to the resolution setting in the MIDI preferences (Setups > Preferences > MIDI).

**Line** Draws a straight line. In audio tracks, the line has a single breakpoint at either end. In MIDI tracks, the controller value changes in steps according to the resolution setting in the MIDI preferences (Setups > Preferences > MIDI).

**Triangle** Draws a sawtooth pattern that repeats at a rate based on the current Grid value. In audio tracks, the pattern has a single breakpoint at each extreme. In MIDI tracks, the controller value changes in steps according to the resolution setting in the MIDI preferences. Amplitude is controlled by vertical movement of the Pencil tool.

**Square** Draws a square pattern that repeats at a rate based on the current Grid value. Amplitude is controlled by vertical movement of the Pencil tool.

**Random** Draws a random pattern of levels that change at a rate based on the current Grid value. Amplitude is controlled by vertical movement of the Pencil tool.

## Using Pencil Tool Shapes

You can draw automation for audio as well as MIDI tracks. For example, use the Triangle pattern to control continuous functions, or the Square pattern to control switched functions such as Mute or Bypass.

Since the pencil draws these shapes using the current Grid value, you can use it to perform panning in tempo with a music track, or on frame scene changes when working in post production.

 For more information on MIDI continuous controller data, see “Continuous Controller Events” on page 364.

## Resolution of MIDI Controller Data

When using the Pencil tool to draw MIDI automation, the data is drawn as a series of discrete steps. You can control the resolution (or density) of these steps to help manage the amount of MIDI data sent for a given MIDI controller move.

### To set the resolution for the Pencil tool:

- 1 Choose Setups > Preferences and click the MIDI tab.
- 2 Enter a value for “Pencil Tool Resolution When Drawing Controller Data.” The value can range from 1 to 100 milliseconds.

The illustrations below show the same MIDI controller automation drawn with different Pencil Tools resolution settings.

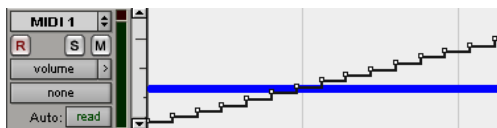

MIDI Data drawn with resolution of 10 ms

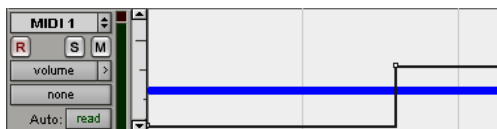

MIDI Data drawn with resolution of 100 ms

For better performance, consider selecting a smaller value for MIDI controls that need higher resolution (such as MIDI volume), and a larger value for controls that may not require a high resolution (such as Pan).

---

## Editing Automation

Pro Tools provides several ways to edit automation data for any track in your session. You can edit automation data graphically, by adjusting breakpoints on the automation playlist of a track. You can also cut, copy, and paste automation data in the same manner as audio and MIDI data.

### Graphical Editing of Automation Data

Automation data takes the form of a line graph with editable breakpoints. By dragging these breakpoints, you can modify the automation data directly in the Edit window. When you drag an automation breakpoint up or down, the change in value is numerically or textually indicated. Dragging an automation breakpoint to the left or right adjusts the timing of the automation event.

### Using the Grabber

The Grabber lets you create new breakpoints by clicking on the graph line, or adjust existing breakpoints by dragging them. Alt-click (Windows) or Option-click (Macintosh) breakpoints with the Grabber to remove them.

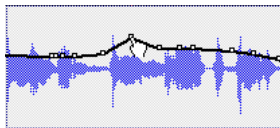

*Using the Grabber to create a new breakpoint*

### Using the Pencil Tool

The Pencil tool lets you create new breakpoints by clicking once on the graph line. Alt-click (Windows) or Option-click (Macintosh) breakpoints with the Pencil tool to remove them.

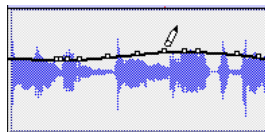

*Using the Pencil to delete a breakpoint*

### Using the Trimmer

The Trimmer lets you adjust all selected breakpoints up or down by dragging anywhere within that selection.

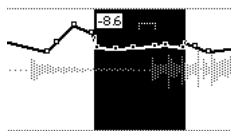

*Using the Trimmer to move breakpoints*

## Editing Automation Types

Each automatable control has its own automation playlist, that can be displayed by choosing it from the Track View Selector. “Viewing Automation” on page 458.

### Editing Volume Automation

Drag a breakpoint up or down to change the volume (dB value). Drag a breakpoint to the left or right to adjust the timing of the volume change.

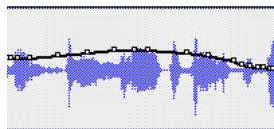

*Track volume automation*

## Editing Pan Automation

Drag a breakpoint down to pan right, and up to pan left. Drag a breakpoint to the left or right to adjust the timing of the panning moves.

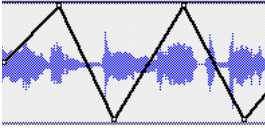

Track Pan automation

## Editing Mute Automation

Drag the breakpoint down to mute a section. Drag a breakpoint up to unmute the section. Drag a breakpoint to the left or right to adjust the timing of the mute.

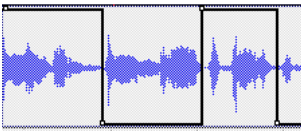

Track mute automation

## Editing Stepped Control Automation

Automation for certain controls (such as MIDI controller values or plug-in settings) appears as a stepped pattern on the breakpoint line. Drag a breakpoint up or down to a different step to change to a new control value. Drag a breakpoint to the left or right to adjust the timing of the stepped control change.

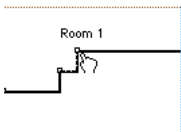

Stepped control automation

## Editing Automation Breakpoints

To edit automation breakpoints, display the automation playlist for the control you want to edit by selecting it from the Track View Selector, then do one of the following:

### To create a new breakpoint:

- Click with the Grabber (or the Pencil) on the line graph.

### To edit one breakpoint:

- Click an existing point on the line graph with the Grabber and drag it to a new position.

### To clear one breakpoint:

- Alt-click (Windows) or Opt-click (Macintosh) with the Grabber.

### To edit several breakpoints at once:

- Use the Selector to select a range in the automation playlist that contains the breakpoints, and do one of the following:
  - To move the breakpoints earlier or later in the track, press the Plus key (+) to nudge them later (to the right) or the Minus key (-) to move them earlier (to the left). The breakpoints move by the current Nudge value.
  - To adjust the breakpoint values, click with the Trimmer in the selection and drag the breakpoints up or down.



*When you use the Trimmer to edit a selection containing breakpoints, new anchor breakpoints are created before and after the selected area. To suppress creation of anchor breakpoints, press Alt (Windows) or Option (Macintosh) while using the Trimmer.*

### To edit all breakpoint values in a region:

- Click in the region with the Trimmer and drag the breakpoints up or down.

## Editing Automation on Stereo and Multichannel Tracks

Stereo and multichannel tracks display a single automation playlist per track. Only one playlist for volume and mute is available for the stereo or multichannel track.

For multi-mono plug-ins, automation playlists for each individual channel can be displayed and edited when the plug-in is unlinked, and the track is in Expanded Track Display.

### Expanded Track View

By default, a single automation playlist is displayed on stereo and multichannel tracks. The playlist occupies the entire height of the track (similar to mono automation playlists).

Optionally, you can display an expanded view of the track whereby the same automation playlist is displayed across each channel.

### Plug-In Automation Playlists on Stereo and Multichannel Tracks

Some multichannel plug-ins provide a single set of automatable controls for all channels in a track. Other multi-channel plug-ins and all multi-mono plug-ins provide a single set of controls for all channels when linked, or discrete controls for each channel when unlinked. Refer to your plug-in guide for more information.

### To view and edit the individual playlists of a multi-mono plug-in:

- 1 Unlink the plug-in.

- 2 Select the required playlist from the Track View Selector.

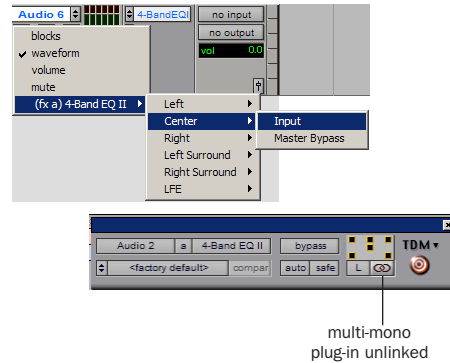

### Selecting an automation playlist for an unlinked multi-mono plug-in

## Editing Automation on Grouped Tracks

When you edit automation on an audio track that is a member of an active Edit Group, the same type of automation (with the exception of audio and MIDI Pan controls) is also edited on all tracks that are part of that group. This occurs even if the playlist for that type of automation is not currently displayed on the other grouped tracks.

However, when you edit automation on a MIDI track that is a member of an active Edit Group, grouping is ignored; the same type (with the exception of audio and MIDI Pan controls) are not edited on all tracks that are part of that group. To edit all members of MIDI group, see the steps below.

### Examples

- ◆ If you create new automation breakpoints on a grouped track (with the Grabber or Pencil), other members of the group have breakpoints placed relative to that track.
- ◆ If you move volume or send automation on a grouped track (with the Trimmer), other members of the group have their volume or send breakpoints trimmed relative to that track. This lets you trim entire sections of a mix.

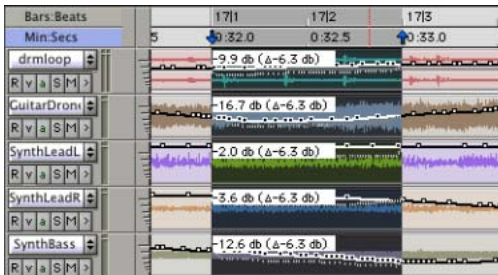

Trimming automation on an active grouped track

**To individually edit a member of a group without affecting the other members:**

- For audio tracks, press the Start key (Windows) or Control (Macintosh) while you perform the edit.

– or –

- For MIDI tracks, do *not* press the Start key (Windows) or Control (Macintosh) while you perform the edit.

**To edit all members of a group:**

- For audio tracks, do *not* press the Start key (Windows) or Control (Macintosh) while you perform the edit.

– or –

- For MIDI tracks, press the Start key (Windows) or Control (Macintosh) while you perform the edit.

**⚠** *When editing automation, audio and MIDI Pan controls work opposite from the way all other controls work.*

*For audio tracks, when you edit or trim Pan breakpoints, Edit Groups are not obeyed. For grouped behavior, press the Start key (Windows) or Control (Macintosh) while trimming.*

*For MIDI tracks, when you edit or trim Pan breakpoints, Edit Groups are obeyed. For individual behavior, press the Start key (Windows) or Control (Macintosh) while trimming.*

## Cutting, Copying, and Pasting Automation

*Cutting* automation data is different from *deleting* it, and yields different results (although both change the existing automation data). *Copying* automation leaves the original automation data intact.

You *delete* automation data by selecting a range of breakpoints and pressing Backspace (Windows) or Delete (Macintosh). See “Deleting Automation” on page 464 for details.

You *cut* automation data by selecting a range of breakpoints from an automation playlist and selecting the Cut command.

When you cut automation data and when you paste it into a new location, anchor breakpoints are added to the beginning and end points of the data. This is done to preserve the true slope (of continuous controls, such as Volume faders or pans) or state (of switched or stepped controls, such as Mutes) of the automation data both inside and outside the selection.

The following illustrations show the difference between cutting and deleting automation data. In Figure 29, a track is set to display volume automation, and a range of automation data is selected.

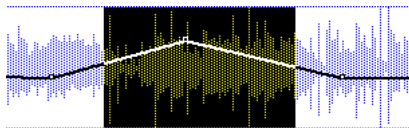

Figure 29. Selecting automation data

If the Cut command is chosen, anchor breakpoints are created at each end of the selection, and the automation slope on either side of the cut data is preserved, as shown in Figure 30.

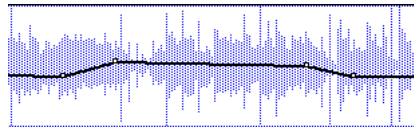

Figure 30. After cutting the automation data

If the data is deleted by pressing Backspace (Windows) or Delete (Macintosh), the automation data is removed, and automation values span the gap between pre-existing breakpoints, as in Figure 31.

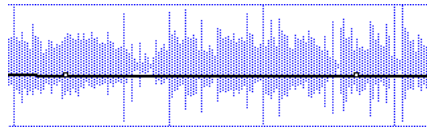

Figure 31. After deleting the automation data

In addition, if cut or copied data is pasted elsewhere in a track, breakpoints are created at the end points of the pasted data to preserve its “neighboring” (incoming and outgoing) automation value and slope, as shown in Figure 32.

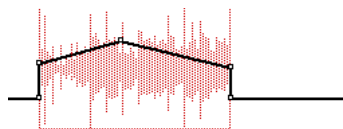

Figure 32. After pasting the automation data in another location

## Editing and Track Views

Audio and MIDI tracks each have a Track View that acts as the main format for purposes of editing. When the main format is displayed, any edits performed on the track apply to all data in the track.

The main view formats are:

- Audio tracks: Blocks and Waveform
- MIDI tracks: Blocks, Regions, and Notes

For example, when an audio track is set to Waveform or Blocks, cutting, copying and pasting affects the audio data and all types of automation data on that track. If the track is set to show Pan automation, only the Pan data is affected.

When a selection includes multiple tracks, if any of those tracks is in its main view format, *all* data on all selected tracks is affected.

To edit all automation types on an Auxiliary Input or Master Fader track, do one of the following:

- Make an edit selection that includes at least one audio or MIDI track that is displayed in its main format.
  - or –
- Press Control while cutting or copying the automation data.



*For additional flexibility, you can use playlists or the Duplicate Track command to work nondestructively on a copy of the edit data.*

### **Tips for Cutting, Copying and Pasting**

- ◆ On audio tracks, when you are in Waveform View and cut or copy a section of the waveform, any automation data associated with the waveform is also cut or copied.
- ◆ On audio tracks, when you are in Waveform View and cut audio data from a track also containing automation data, breakpoints are automatically created at the boundaries of the remaining automation data.
- ◆ On audio tracks, pasting waveform data also pastes any associated automation data.

- ◆ On Auxiliary Input or Master Fader tracks, only the displayed automation data is cut or copied. To cut or copy all automation data on these types of tracks, press Control while cutting or copying.

- ◆ In tracks where an automation playlist contains no data (when there is only a single breakpoint at the very beginning of the track), if you cut data, no new breakpoints are created.

- ◆ In cases where regions overlap (such as when moving regions in Slip mode) and an overlapping region is removed, any overlapped automation breakpoints are lost.

- ◆ If cut or copied data contains a type of automation not currently on the target track, Pro Tools prompts you before allowing you to paste the data.

- ◆ Cut or copied automation data for plug-ins or sends that do not exist on the target track is ignored when pasted.

### **Special Paste Function for Automation Data**

Normally, when you copy and paste automation data, it is pasted in an automation playlist of the exact same type (for example, Left Pan data is pasted into the Left Pan playlist).

However, there may be times when you want to paste from one data type to another (for example, pasting Send 1 level data into the Send 2 level playlist, or track mute data into the send mute playlist).



### To paste data into a different automation playlist:

- Press the Start key (Windows) or Control (Macintosh) when choosing Edit > Paste.

For this special paste mode to function, the following must be true:

- Every track selected for pasting must be currently displayed as automation data.
- There must be only one automation playlist on the Clipboard for each target track. (The Special Paste function cannot copy multiple automation playlists for each track.)

**⚠** *You cannot interchange automation data between audio and MIDI tracks, or between continuous controls (such as faders or pans) and switched or stepped controls (such as mute or MIDI controllers).*

---

## Writing Automation to the Start, End or All of a Selection

### (TDM Systems Only)

Pro Tools lets you write current automation values from any insertion point forward (or backward) to the end (or beginning) of a selection or track, or to an entire selection or track, while performing an automation pass.

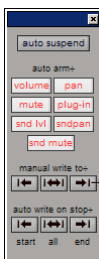

Write to Start, End, All

**Write to Start, All, End controls in the Automation Enable window**

The standard Write to Start/All/End commands do not operate when the Pro Tools transport is stopped. It only affects automation for those parameters that are currently write-enabled and currently writing automation data.

Optionally, Write to Start, End, and All can be configured to always be applied automatically. See “Write to Start, End, and All On Stop” on page 474.

### Requirements for Write to Start, End, and All

For a automation data to be written for a specific parameter, the associated track must be in one of the following Automation modes and meet the following conditions:

**Latch Mode** The control for the parameter must be changed (touched) during the automation pass.

**Touch Mode** The control for the parameter must be changed (touched).

**Write Mode** All controls on that track must be in Auto Write mode.

This command can be undone (Edit > Undo).

### To write current automation values to the start, end, or all of a track or selection:

**1** In the Automation Enable window, make sure that the automation type is write-enabled.

**2** Click in a track at an insertion point.

– or –

Drag with the Selector to select a portion of the track.

**3** Click Play to begin playback.

4 Make sure you are actively writing on the appropriate track if you are in Latch or Touch mode.

5 When you reach a point in the track or selection that contains the automation data you want to apply, click Write to Start, Write to All, or Write to End in the Automation Enable window.

The current values of all write-enabled automation at that point are written to the corresponding area of the track/selection.

## Trim Mode

Using Trim mode, it is also possible to write trim delta values for track volume and send levels to the start (beginning), end or all of a track.

### To write current trim delta values to the start, end, or all of a track or selection:

- 1 In the Automation Enable window, make sure that the automation type (track volume or send level) is write-enabled.
- 2 Click the Automation Mode Selector on the track. Select Trim from the pop-up menu to enable Trim mode. The track volume and send level faders turn yellow.
- 3 Click in a track at an insertion point.  
– or –

Drag with the Selector to select a portion of the track.

- 4 Click Play to begin playback.
- 5 When you reach a point in the track or selection that contains the trim setting (delta value) you want to apply, click the Write to Start, Write to All, or Write to End button in the Automation Enable window.

The relative changes to the track volume and send levels at that point are written to the corresponding area of the track/selection.

## Write to Start, End, and All On Stop

The Automation Enable window provides options for automatic Write to Start, End, and All On Stop.

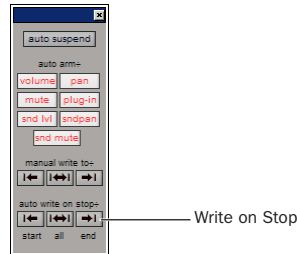

### Write On Stop controls in the Automation Enable window

#### To configure Write on Stop:

- 1 Open the Automation Enable window.
- 2 Click to enable one of the Write On Stop modes (Start, End, or All).

When any of these options are enabled, automation writing will be performed automatically after a valid automation pass has been performed. See “Requirements for Write to Start, End, and All” on page 473.

---

## Trimming Automation

### (TDM Systems Only)

If you have already written automation, you can modify automation data for track volume and send levels in real time by using Trim mode. When a track is trim-enabled, you are not recording absolute fader positions, but relative changes in the existing automation. See “Trim Mode” on page 454 for more information.

#### To enable Trim mode:

- Click the Automation Mode Selector and choose Trim from the pop-up menu.

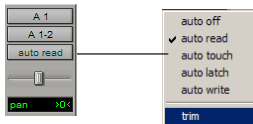

#### Enabling Trim mode

When Trim mode is enabled for a track, its volume and send level faders turn yellow, and its Automation Mode button is outlined in yellow. This outline flashes to indicate that the track is trim-enabled, and appears solid whenever trimming is occurring on the track’s volume or send levels.

#### To trim track volume or send levels in real time:

- 1 In the Automation Enable window, make sure the automation type (volume or send level) is write-enabled.
- 2 Click the Automation Mode Selector, and choose an Automation mode:
  - Use Auto Touch or Auto Latch to have the faders follow existing automation, so you can “chase” them during the automation pass.
  - Use Auto Write if you want to disengage the faders from existing automation.

- 3 Click the Automation Mode Selector on the tracks you want to automate and select Trim from the pop-up menu.

- 4 Click Play to begin trimming automation, and move the volume or send level faders.

- 5 When you have finished, click Stop.

---

## Creating Snapshot Automation

### (TDM Systems Only)

Pro Tools lets you write automation data values for multiple parameters in a single step. You can write snapshot automation in two ways:

**To a selection** Automation data is written to the Timeline selection (as well as the Edit selection if linked). Anchor breakpoints are placed just before and after the selection so that data outside the selection is not affected.

**To a cursor location** Automation data is written at the insertion point. After the insertion point, the automation ramps to the next breakpoint value, or if no breakpoints exist, remains at the newly written value for the remainder of the session.

For more information on cutting, copying, and pasting automation data within a session, see “Writing Automation to the Start, End or All of a Selection” on page 473.

#### To write snapshot automation:

- 1 In the Edit window, click the Track View button to show the automation you want to edit.
- 2 In the Automation Enable window, make sure that the parameters you want to edit are write-enabled. Deselect any parameters whose automation you want to preserve.

**3** Select an area in the track's playlist (or within multiple tracks) where you want to apply the automation.

– or –

Place the cursor at an Edit insertion point.

**4** Adjust the controls you want to automate. You can also change a plug-in preset.

**5** Choose Edit > Write Automation and do one of the following:

- To write the current value to only the currently displayed automation parameter, choose To Current Parameter.
- To write the current settings for all automation parameters enabled in the Automation Enable window, choose To All Enabled Parameters.

### **Adding Snapshot Automation to Empty Automation Playlists**

When you use the Write Automation command on an automation playlist with no previously written automation data, the selected value is written to the entire playlist and not just the selected area.

This is because a playlist with no automation data contains only a single automation breakpoint that corresponds to the current position of the control for the parameter. The position of the breakpoint is updated whenever the parameter value is changed.

If you do not want the Write Automation command to write the selected automation value to the entire playlist, you can:

- Anchor the automation data by placing the cursor at the end of the session (or any other endpoint) and choosing Write Automation To Current Parameter.
- or –
- Click with the Grabber on each side of the selection.

This lets the Write Automation command write only to the selected area.

### **Writing Snapshot Automation over Existing Automation Data**

When you move the playback cursor, the automated controls in Pro Tools update on the screen to reflect the automation data that is already on the track. To keep the settings you have made for a snapshot, you can suspend automation parameters to prevent them from updating.

#### **To write snapshot automation over existing data:**

- 1** In the Automation Enable window, make sure that the automation parameters you want to edit are write-enabled. Deselect any parameters whose automation you want to preserve.
- 2** Adjust the controls for the parameters you want to automate.
- 3** From the Automation Mode pop-up menu, select Auto Off for the tracks you want to apply the automation.
- 4** With the Selector, select the track range you want to apply the automation.

5 Choose Edit > Write Automation and select one of the following from the submenu:

- To write the current value to only the automation parameter currently displayed in the Edit window, choose To Current Parameter.
- To write the current settings for all automation parameters enabled in the Automation Enable window, choose To All Enabled Parameters.

6 From the Automation Mode pop-up menu, select Auto Read for the tracks you want to play back with automation.

## Capturing Automation and Applying it Elsewhere

The Write Automation command can also be used to capture automation states at specific locations in a session and apply them to other locations. This differs from simply copying and pasting automation data in that you can set any selection length for the application of the captured automation data.

### To capture and apply automation:

1 In the Automation Enable window, make sure that the automation parameters you want to edit are write-enabled. Deselect any parameters whose automation you want to preserve.

2 Click with the Selector in the track with the automation you want to capture. All automated controls update to reflect the automation at that location. (If you make a selection, the controls update to reflect the automation at the beginning of the selection.)

3 From the Automation Mode pop-up menu, select Auto Off for the tracks you want to apply the automation.

4 With the Selector tool, select the location where you want to apply the automation.

5 Enable the automation parameters previously suspended.

6 Choose Edit > Write Automation and select one of the following from the submenu:

- To write the current value to only the automation parameter currently displayed in the Edit window, choose To Current Parameter.
- To write the current settings for all automation parameters enabled in the Automation Enable window, choose To All Enabled Parameters.

7 From the Automation Mode pop-up menu, select Auto Read for the tracks you want to play back with automation.

## Snapshot Automation and Trimming of Automation Data

Pro Tools lets you use trim values as snapshots and apply the *relative* changes (delta values) to the selected automation by using the Trim Automation command. This works in much the same way as the Write Automation command, except that it writes delta values instead of absolute values to automation data.

You can use trim values in writing snapshot automation to any automatable parameter.

### To create a snapshot of relative changes in automation data:

1 In the Automation Enable window, make sure that the automation parameters you want to edit are write-enabled. Deselect any parameters whose automation you want to preserve.

2 Select the area of the track you want to edit. All automated controls update to reflect the automation at the beginning of the selection.

**3** Move the controls for the parameter up or down by the amount you want to change the data.

**4** Choose Edit > Trim Automation and do one of the following:

- To write the current delta value to only the currently displayed automation parameter, choose To Current Parameter.
- To write the current delta value for all automation parameters enabled in the Automation Enable window, choose To All Enabled Parameters.

# Chapter 29: Mixdown

Pro Tools lets you *record* and *bounce* tracks to disk. The Bounce to Disk command lets you write a final mix to disk, create a new loop, print effects, or consolidate any submix. You can also submix, route, and record busses and inputs to new audio tracks.

**Bounce to Disk** This command writes the current session (if no selection), Edit, or Timeline selection as new audio files to disk. Any available output or bus path can be selected as the bounce source. Use Bounce to Disk to write or master any output or bus path directly to disk. Sample rate, bit depth, and other conversion processes can be applied during or after the bounce. The Bounce to Disk command lets you bounce all available voices to disk without holding any in reserve. Though you can hear the bounce being created in real time, you cannot adjust mixer or other controls during a Bounce to Disk.

**Recording to Tracks** This is the process of submixing and recording to new audio tracks, as you would any input signals. This method requires available tracks, voices, and bus paths to accommodate the submix and the new tracks. While recording to tracks, you can adjust mixer or other controls.

## Selecting Audio for Loops, Submixes, and Effects

Both Bounce to Disk and recording to tracks operate on the current Timeline or Edit selection, if any. This makes it easy to turn multitrack selections into mono, stereo, or multichannel loops. Submixes, stems, and other specialized types of mixes can also be printed to disk using either method, or recorded out to a DAT, MDM, or other recording, transfer, or archiving medium.

Printing effects to disk is the technique of permanently adding real-time effects, such as EQ or reverb, to an audio track by bussing and recording it to new tracks with the effects added. The original audio is preserved, so you can return to the source track at any time. This can be useful when you have a limited number of tracks or effects devices.

 *AudioSuite plug-ins provide another option for printing a plug-in effect to disk. See the DigiRack Plug-Ins Guide for details.*

Use Bounce to Disk if you need to convert the bounce files, or if you do not want or need to interact with mixer controls during the bounce.

Record to new tracks if you want to adjust controls while the files are being written.

## Dither and Bounce to Disk

Dithering can significantly improve audio quality. Generally, dithering is necessary when reducing the bit depth for digital audio.

If you use Bounce to Disk, it is important to understand that the Bounce to Disk process does *not* apply dither.

To dither a bounce file, you should insert one of the included Digidesign Dither plug-ins (such as POW-r Dither), or another dithering plug-in, on a Master Fader assigned to the bounce source path. Master Faders are often preferable to Auxiliary Inputs because Master Fader inserts are post-fader (better for dithering).

If you do not use a dithering plug-in on your bounce source path, and you choose to convert to a lower resolution during or after a Bounce to Disk, the resultant file will be converted by truncation.

### When to Use a Dithering Plug-In

You should use a dithering plug-in in any situation where you are reducing bit depth, for example, when mastering to a 16-bit file with the Bounce To Disk command, or when mastering to an external device that records at 16-bit.

This is even necessary when using 16-bit sessions. Even though 16-bit sessions use 16-bit files, they are still being processed at a higher bit rate:

- 24-bit audio input and output signal paths with internal 48-bit mixing and processing for Pro Tools TDM systems
- 24-bit audio input and output signal paths with internal 32-bit floating point processing for Pro Tools LE systems

For this reason, whether you are using a 16-bit session or a 24-bit session, it is recommended that you use a Dither plug-in when mastering to 16-bits.

When mastering to 24-bits, it is not necessary to use a Dither plug-in.

### Using Dither on an Output Mix

Pro Tools includes real-time dithering plug-ins that improve 16-, 18-, or 20-bit performance and reduce quantization noise when mixing or fading low-level signals.

The dithering plug-ins have no user-selectable controls other than Bit Resolution and Noise Shaping controls.

 For more information about dither, see “Dither” on page 430.

#### To use a dithering plug-in on a submix:

- 1 Choose File > New Track and select Master Fader (stereo) from the pop-up menu.
- 2 Set the output of the Master Fader to the output or bus path you want to bounce.
- 3 Assign the outputs of all audio tracks in the session to the same path you selected in step 2. The Master Fader now controls the output levels of all tracks routed to it.
- 4 On the Master Fader, click an Insert button and choose one of the Digidesign dithering plug-ins (such as POW-r Dither).
- 5 In the dithering plug-in window, choose an output Bit Resolution and Noise Shaping setting.



When you Bounce to Disk you can convert the file to the appropriate resolution. Before being converted by the Bounce to Disk command, the signal will have been dithered to the resolution and noise shaping settings in a dithering plugin.

 *For more information about the Digidesign dithering plug-ins, refer to the DigiRack Plug-Ins Guide.*

---

## Recording to Tracks

You can create a submix in your Pro Tools session and record it to available tracks in the same session. This technique lets you add live input to the mix, as well as adjust volume, pan, mute, and other controls during the recording process. You can also use this technique instead of Bounce To Disk, to create mixed tracks directly in your Pro Tools session.

### Voice Requirements

Recording a submix to new tracks requires an available voice for each track that you want to record. Make sure you have enough voices available to play back all tracks that you want to record and enough voices available to record the destination tracks.

In contrast, the Bounce to Disk command lets you bounce all available voices to disk without holding any in reserve, but you cannot manually change any controls during the bounce. See “Bounce to Disk” on page 482 for more information.

 *For information about voice management, see “Track Priority and Voice Assignment” on page 96.*

### To record a submix:

- 1 Apply any plug-ins or external processors you want to add to your audio tracks or Auxiliary Inputs before you record.
  - 2 Set the main channel output of the tracks you want to include in the submix to a bus path. If you are using stereo or multichannel tracks, set the panning of each track.
  - 3 Choose File > New Track and create one or more mono, stereo, or multichannel audio tracks.
  - 4 If you are recording in stereo, pan the new stereo track (or two mono tracks) hard left and right.
  - 5 Set the input of each destination track to match the bus path from which you are recording.
  - 6 Set the output of your new tracks to your main output path.
-  *If you are working with 16-bit files, and you are recording submixes, you should apply dither on the Master Fader.*
- 7 Select Operations > Link Edit and Timeline Selection.
  - 8 Select audio to record. The start, end, and length of the recording can be based on cursor location or Edit and Timeline selections.
    - Selection-based recording automatically punches in and out of recording at the selection start and end. Be sure to include time at the end of a selection for reverb tails, delays, and other effects.
    - If you don't make a selection, recording will begin from the location of the playback cursor. Recording will continue until you press Stop.
  - 9 Record enable the new tracks and click Record in the Transport window.

**10** Click Play in the Transport window to begin recording the submix.

**11** If recording a selection of audio, recording will stop automatically. If performing an open-ended recording, click Stop, or punch out of recording. Make sure Loop Playback is not enabled.

---

## Bounce to Disk

The Bounce to Disk command lets you mix down with all available voices on your system. Since it records to separate audio files, you don't have to reserve any tracks for a bounce.

Pro Tools bounces are done in real time, so you hear audio playback of your mix during the bounce process (though you can't adjust it).

You can use the Bounce to Disk command to create and automatically import loops, submixes, or any audio into your session. You can use it to create a final mono, stereo, or multi-channel master, in any of several audio file formats. Bounce to Disk provides conversion options for sample rate, bit resolution, and format.

When you bounce a track to disk, the bounced mix includes the following:

**Audible Tracks** All audible tracks that are routed to the output which is selected as the source of the bounce are included in the bounce. Any muted tracks are not included in the bounce. If you solo one or more tracks, only the soloed tracks are included in the bounced mix.

**Automation** All read-enabled automation is played back and incorporated in the bounced mix.

**Inserts and Sends** All active inserts, including real-time plug-ins and hardware inserts, are applied to the bounced mix.

**Selection or Track Length** If you make a selection in a track, the bounced mix will be the length of the selection. If there is no selection in any track, the bounce will be the length of the longest audible track in the session.

**Time Stamp Information** Bounced material is automatically time stamped so that you can drag it into a track and place it at the same location as the original material. For more information about time stamping, see "Time Stamping" on page 570.

### Bounced Files Are "Delay-Compensated"

Pro Tools compensates for any bus delays due to a bounce. This means that if a bounce file is imported back into a session, and placed directly in time against the source mix, it is time-aligned with the original source mix.

### Record-Enabled Tracks and TrackInput Enabled Tracks Cannot Be Bounced

Pro Tools does not allow you to bounce tracks that are either record-enabled or in Input Only monitoring mode.

### To Bounce to Disk:

- 1 Choose File > Bounce to Disk.
- 2 Configure bounce options as needed and perform the bounce (see "Bounce Options" on page 483).

### Bouncing with Mute Frees Assigned Voice (TDM Systems Only)

When bouncing sessions that include muted tracks, enabling "Mute Frees Assigned Voice" can, in some instances, increase the number of tracks that can be successfully bounced. See "Mute Frees Assigned Voice" on page 102.

## Bounce Options

When you use the Bounce to Disk command, you can configure several file options.

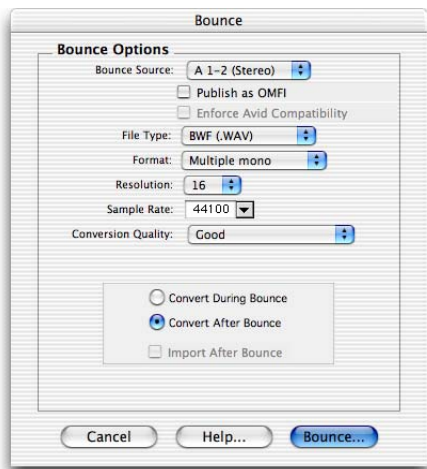

**Bounce to Disk dialog, with conversion and options enabled**

## Default Settings

Available options and their default settings are listed in the following table.

### Options and Default Settings

Bounce Option	Default
Bounce Source	current main output path
File Type	session default file type
Format	Auto Stereo Interleaved
Resolution	session default resolution
Sample Rate	session default sample rate
Conversion Quality	Good
Use Squeezer (8-bit only)	deselected
Convert During Bounce	deselected
Convert After Bounce	selected
Import After Bounce	deselected

## Bounce Source

Select any mono, stereo, or multichannel output or bus path as the source for the bounce. All currently active paths as defined in the I/O Setup dialog are available as the Bounce Source.

### To set the bounce source:

- Select an output or bus path from the Source Selector.

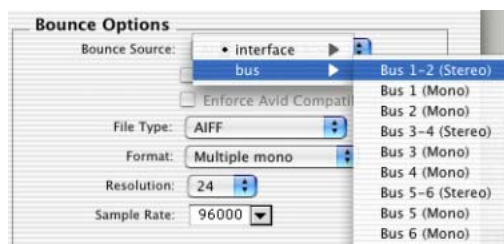

Select a bounce source

## File Type

Selects the (creator) type for the bounced files.

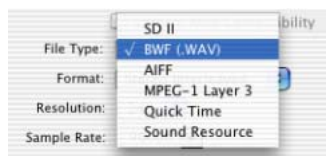

Selecting a file type

## Sound Designer II

This was the native format for older Macintosh-based Pro Tools systems. Select this to use the bounced audio with any Digidesign application for Macintosh.

## BWF (Broadcast .WAV Format)

This was the native format for older Windows-based Pro Tools systems, but is now supported on Windows and Macintosh. To use a BWF (.WAV) file in Pro Tools, you can drag and drop from the DigiBase Browser, or use the Import Audio command. Files in this format do not have to be converted to be used in Pro Tools.

## AIFF (Audio Interchange File Format)

To use an AIFF file in Pro Tools, you can drag and drop from the DigiBase Browser, or use the Import Audio command. Files in this format do not have to be converted to be used in Pro Tools. AIFF waveform overview data is calculated and saved to a cache file, which is accessed each time the session is opened.

## SND Resource

### (Macintosh Only)

This file type is supported by some Macintosh software applications and also by Macintosh System Software. Pro Tools does not directly support this type of file in its sessions. To use a SND file within Pro Tools, use the Import Audio command. The SND format is useful if you plan to use your audio with other Macintosh applications that do not support Sound Designer II or AIFF formats. To use a bounced file as a System alert sound, save it in this format and then drag it onto the Macintosh System File.

## QuickTime

### (Macintosh Only)

This is Apple's audio file format for QuickTime-based multimedia. Pro Tools does not directly support this type of file in its sessions. To use a QuickTime audio file within Pro Tools, use the Import Audio from Other Movie command. The QuickTime format is popular for attaching to emails, to simplify long-distance project review and approval. Many popular multimedia applications also support QuickTime.

## Windows Media

### (Windows Only)

Windows Media formatted files can contain audio, video, or script data stored in Windows Media Format. A Windows Media Format file may have an .asf, .wma, or .wmv file name extension.

## RealAudio G2

### (Windows and Mac OS 9 Only)

RealAudio G2 was created by Real Networks for streaming audio over the Internet. The RealAudio encoder file is stored in a folder named CoDecs inside the DAE folder.

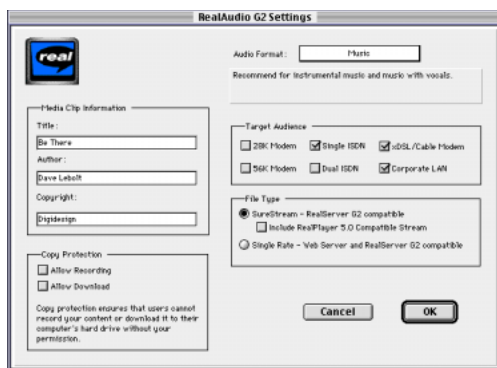

### RealAudio G2 Output Options

When you select this format, the Resolution and Sample Rate pop-up menus in the Pro Tools Output Options dialog are unavailable, because resolution and sample rate are set by the encoder.

The RealAudio G2 format lets multiple streams with different bit rates be encoded into a single file. During playback, the RealAudio G2 server and the RealPlayer G2 client continuously adjust the bit rate to make the best use of available bandwidth. The RealPlayer G2 is available on the Real Networks Web site ([www.real.com](http://www.real.com)).

When you export or bounce to RealAudio G2 format, you can set the following options:

**Media Clip Information** Type the title, author, and copyright information for your RealAudio clip. This information is displayed on the RealPlayer G2 as the clip plays back.

**Copy Protection** These settings determine how the clip is handled by the RealPlayer client.

- To let RealPlayer Plus users save your clip using the RealPlayer Plus recording feature, select Allow Recording.
- To let RealPlayer users download your clip to their hard drive, select Allow Download.

If you don't want RealPlayer users to make copies of your clip, deselect both of these options.

**Audio Format** From the pop-up menu, select the setting that best matches the type of audio you are bouncing. A brief explanation of each format is displayed.

**Target Audience** Select the connection speed that most users downloading your clip are likely to have. This setting determines the bit rate at which the audio will be encoded. Depending on the file type you choose (see below), you can choose more than one connection speed.

**File Type** This option determines the compatibility of the output file with different RealAudio servers and clients.

If you select SureStream, you can select more than one connection speed under Target Audience. With this file type, multiple bit rate streams are encoded into a single output file. Files encoded with the SureStream option are larger than Single Rate files, and can only be played back from G2 servers.

Select the “Include RealPlayer 5.0 Compatible Stream” option to include a backward compatible stream that can be played on older version 5.0 RealPlayers. (This backward compatibility is only available for SureStream-encoded files.)

If you select Single Rate, you can only select one connection speed under Target Audience. With this file type, a single stream is encoded into the output file. Files encoded with the Single Rate option can be played back from either a standard web server or a G2 server.

### MP3 (MPEG Layer 3)

The MPEG-1 Layer 3 compression format (MP3) is used for streaming and downloading audio over the Internet, and for playback on portable devices. The MP3 option is required to use this file type.



#### MP3 Output Options

On Windows and Mac OS 9, the MP3 encoder file is stored in a folder named Codecs inside the DAE folder; on Mac OS X, the MP3 encoder file is stored in Applications/Pro Tools/Codecs/MP3/. This version of the encoder uses the latest technology from the developer of the MP3 format, the Fraunhofer Institute. It features improved processing speed and quality, and supports both constant and variable bit rate encoding.

The MP3 encoder provided as an install option with Pro Tools is a fully functional 30-day demo version. To purchase the full version of the MP3 encoder, visit Digidesign’s Web site ([www.digidesign.com](http://www.digidesign.com)).

When you select this format, the Resolution pop-up menu in the Pro Tools Output Options dialog is unavailable. The resolution is set by the encoder.

The sample rate chosen is given to the codec as a “base” sample rate for operations. The actual sample rate of the resulting file is determined in the MP3 Encoder Options dialog. For example, if a base sample rate of 48000 Hz is chosen, the MP3 Encoder Options dialog will allow output streams in 48, 24, or 12 kHz, depending on encoding quality.

When you export or bounce to MP3 format, you can set the following options:

#### Encoder Settings

**Encoding Quality** Determines the audio quality of the bounced file. The higher the quality, the longer it will take to process the audio. The three options, in ascending order of quality, are Fastest Encoding, Medium Encoding, and Highest Quality.

The Highest Quality setting can take up to five times longer to process audio than the Fastest Encoding setting, so you should use it only when the highest fidelity is essential and you have a considerable amount of time to devote to the encoding process. You should experiment with the other encoding quality settings, since they can provide acceptable quality with a significantly shorter encoding time.

**Encoding Method** Two encoding methods are available:

- **Constant Bit Rate (CBR)** encodes the file at a single bit rate that you choose from the CBR pop-up menu. Because the bit rate is fixed, the quality of the encoded audio will vary depending on the nature of the material being compressed. This option is best for streaming over the Internet, since it has predictable bandwidth requirements.
- **Variable Bit Rate (VBR)** encodes the file at a varying bit rate to maintain the level of encoding quality that you choose from the VBR pop-up menu. The bit rate varies automatically depending on the nature of the material being compressed. This option is best for personal jukebox applications.

### ID3 Tag Info Settings

**ID3 Tag Type** The ID3 tag stores data about the encoded audio file that is used by MP3 players to display information about the file. Pro Tools supports three versions of this tag, in order to provide backward compatibility with older MP3 players:

- **ID3 v1.0:** Appears at the end of a streaming MP3 file, so that tag information is only displayed after software streaming is finished.
- **ID3 v1.1:** Same as version 1.0, but adds track number information to the tag.
- **ID3 v2.3:** Appears at the front of a streaming MP3 file, so that tag information is displayed when streaming begins.

**⚠** *While ID3 v2.3 is becoming the standard MP3 format, not all MP3 players currently support ID3 v2.3. Contact the developer of your player software for compatibility information.*

**Title/Artist/Album/Comment** Type the title, artist, and other information for the MP3 file. This information is displayed by many MP3 players.

**Genre** Choose a genre for the file. This information is displayed by many MP3 players, and can appear in searchable catalogs and databases.

**Track Number** If you select ID3 tag type v1.1 or v2.3, you can enter a CD track number for the file. This information is displayed by many MP3 players.

**Year** Enter a year for the file. This information is displayed by many MP3 players.

### Advanced Settings

The options listed under Advanced Settings, under normal situations, do not need to be changed from their default values.

**Pad To Match Bit Rate Exactly** This option determines whether MP3 frames are padded to maintain bit rate very precisely. You should only select this option if you need a file with an exact bit rate, for specific applications (such as synchronous transmission over an ISDN line).

**⚠** *Padding of MP3 frames can cause problems with some versions of Internet streaming software. If your files are destined for desktop or Internet delivery, do not select this option.*

**Allow Intensity Stereo Coding** This option determines whether the encoder takes into account the frequency of a signal when encoding its phase characteristics, allowing for more compression at low bit rates. In most cases, you should leave this option selected. However, if you are working with highly phase-dependent material, such as Dolby Surround, you may want to deselect this option.



**Write CRC Checksums** This option adds error-detection data to the MP3 file. This data is not necessary for most computer and Internet applications, and also takes away from the space available for audio data. Select this option only if you are sure your delivery mode requires error correction.

**Copyrighted** This option sets a bit in the MP3 data stream to indicate that the audio is copyrighted. Not all MP3 players use this information. Selecting this option does not guarantee that the audio file will not be copied.

**Original** This option sets a bit in the MP3 data stream to indicate that the audio is the original media for the track, rather than a copy. This setting is not widely used.

**Private** This option sets a bit in the MP3 data stream that is interpreted differently by various applications. It is not normally used.

## Mac File Settings

**Mac File Type and Creator** If you expect your file to be used on a Macintosh, you can enter the Macintosh file type and creator. This will allow users to double-click the file to open their MP3 player.

## Default Button

To restore all settings in this dialog to their default values, click Defaults.

## Format

This is the format for the bounced result. Choices are Mono (summed), Multiple mono, and Interleaved.

## To set the bounce file format:

- Select a file format from the Format Selector.

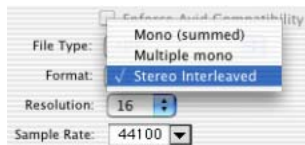

**Mono (Summed)** Creates a single disk file that is a summed mono mix of the current sources being monitored.

When bouncing to mono (summed) files, the output may clip. Avoid clipping by monitoring the meters of your bounce source Auxiliary Input or Master Fader. When bouncing stereo tracks to mono (summed) files, clipping occurs if left and right signals exceed  $-3$  dB below maximum, or full code (0 dBFS).

**Multiple Mono** Creates multiple mono files with the same number of channels as the source path.

- If the source output or bus path is stereo, two mono files will be created, and appended with “.L” and “.R” suffixes on bounce.
- If a multichannel format is used (for example, six-channel, 5.1), individual mono files will be created for each member of the path. Files will be appended with path suffixes according to the path definition in the I/O Setup dialog.
- If the source output or bus path is mono, the pop-up menu will switch from multiple mono to mono, and will create one mono file (no summing of multiple sources).

**Stereo Interleaved** Creates a single, interleaved file that contains all of the bounced streams from the chosen output path. In an interleaved stereo bounce, tracks assigned to odd-numbered outputs are sent to the left channel, and tracks assigned to even-numbered outputs are sent to the right channel.



Pro Tools also lets you create multichannel interleaved files of any supported file type. This can simplify file management of mixes and projects for backup and archiving.

Pro Tools does not support interleaved files natively. This means that they must be split into multi-mono files on import (requiring additional disk space).

## Resolution

This option lets you select between three different bit resolutions for the bounce conversion.

Bounce to Disk does not apply dither when converting during or after a bounce to a lower resolution (including when bouncing to 16-bit). When you need to create a lower resolution bounce file, use a Digidesign Dither plug-in, or similar, on a Master Fader assigned to the bounce source path. This dithers the bounce file, before the Bounce to Disk conversion truncates bits into the final file resolution. (See “Dither and Bounce to Disk” on page 480.)

Resolution choices include the following:

**8-bit** This resolution is often used in multimedia applications. If the material you are working with is relatively simple, you can use the Pro Tools “Squeezer” feature for optimal results. See “Sample Rate Conversion Quality Option” on page 490 for details.

**16-bit** This is the Compact Disc standard bit resolution.

**24-bit** If you plan to use the bounced file with a Pro Tools TDM system, you can take advantage of the greater resolution and headroom afforded by this higher bit rate.

### To set the bounce file resolution:

- Select a bit depth from the Resolution Selector.

## Sample Rate

This option lets you save to any of several sample rates. Choices are dependent on your Pro Tools system and Digidesign audio interfaces.

### Sample Rate Conversion Quality

If you choose a sample rate that differs from the original sample rate of the session, the conversion options become available. You can configure the conversion quality, and schedule conversion to occur during, or after, the bounce. See “Sample Rate Conversion Quality Option” on page 490 for more information.

The following are the more common sample rates, and their application. Higher sampling rates will provide better audio fidelity for recording and playback, and also for processing with dynamics, dither (with noise shaping), and analog emulation plug-ins.

**192000** This is a supported sample rate for some audio DVDs, and provides the highest quality audio fidelity with compatible audio interfaces (such as the 192 I/O).

**176400** You may want to work at a sample rate of 176.4 kHz if the final delivery will be at 44.1 kHz (such as compact disc). This will provide a slightly faster sample rate conversion to 44.1 kHz than from 192 kHz.

**96000** This is a supported sample rate for DVD audio and provides high-quality audio fidelity with compatible audio interfaces (such as the 192 I/O, 96 I/O, 96i I/O, and Digi 002).

**88200** You may want to work at a sample rate of 88.2 kHz if the final delivery will be at 44.1 kHz (such as compact disc). This will provide a slightly faster sample rate conversion to 44.1 kHz than from 96 kHz.

**48000** This is a standard sample rate for Professional and DVD video, and is supported by DA-88/98, DAT, and ADAT decks.

**44100** This is the standard sample rate for compact discs (CD), and is supported by DA-88/98, DAT, and ADAT decks.

**Custom** For a custom sample rate, click in the sample rate window and manually enter in a value.

**Pull-up and Pull-down Rates** All available sample rates support pull-up and pull-down rates, or other specialized rates.

## Sample Rate Conversion Quality Option

The Conversion Quality option sets the quality of sample rate conversion used to create the converted file. The higher the quality of sample rate conversion, the longer it takes to convert the file after the bounce has taken place. There are five possible settings, ranging from Low to Tweak Head. For most applications, the Better setting yields satisfactory results.

### Processing Resources and Conversion Quality

Because the Best and Tweak Head settings take longer than the others, you may want to use them only in cases where the highest fidelity is essential and you are not facing strict time limitations.

## Use Squeezer

The Use Squeezer option uses a proprietary DSP algorithm specifically designed for performing 8-bit conversion of simple source files such as voice-overs. It optimizes the dynamics of the audio by preprocessing it using compression, limiting, and gating before conversion to 8-bit resolution. This results in greater apparent loudness in the signal, and improved intelligibility. If you are converting a more complex 16-bit audio file to 8-bit resolution, test this option before converting all of your material.



*Bounce to Disk, Use Squeezer enabled*

## Convert During or After Bounce

The Bounce dialog can perform any conversion options, including sample rate and bit depth conversion, during a bounce or post-bounce.

**Convert During Bounce** This option may take less time than Convert After Bounce, but does so at the expense of plug-in automation playback accuracy.

**Convert After Bounce** The Convert After Bounce option, though it takes more time, offers the highest level of plug-in automation accuracy possible.

## Import Into Session After Bounce

The Import Into Session After Bounce option automatically imports the newly bounced files into the Audio Regions List so you can place them in tracks. If your newly bounced files are split stereo files, they are listed together in the Audio Regions List.

The Import Into Session After Bounce option is only available if the target bit depth for the bounce is the same or less as the bit depth of the current session, and it is supported by the Digidesign audio interface.

## Help

The Help button opens a display-only dialog that describes the Bounce to Disk features.

---

## Recording a Submix (with Bounce To Disk)

You can create a submix with the Bounce to Disk command by muting tracks or bypassing inserts that are not part of the submix group, and selecting the part of the session you want to bounce. Or, you could solo only the audio you want to bounce.

You can also create a submix by recording to new tracks. For details, see “Recording to Tracks” on page 481.

### To bounce a submix to disk and bring it into the session:

**1** Configure your submix using sends, auxiliary inputs, and master faders. (See “Submixing for Signal Routing and Effects Processing” on page 423.)

**2** Do one of the following:

- To bounce the entire session, click Return to Zero in the Transport window to go to the beginning of the session.
- or –
- To bounce a portion of the session, enable Operations > Link Edit and Timeline Selection, and make a selection in the Edit window.

**3** Choose File > Bounce to Disk.

**4** Configure bounce options and settings.

**5** Verify the bit resolution for the bounced file matches the bit resolution of the session.

**6** Verify the sample rate for the bounced file is supported by the session and the audio interface.

**7** If required, verify the file type and format for the bounced file matches the file type and format of the session.

**8** Select the Import After Bounce option.

**9** Click Bounce.

**10** Select a destination for the new audio file, enter a name, and click Save.

Pro Tools bounces are done in real time, so you hear audio playback of your mix during the bounce process. You cannot adjust controls during a Bounce to Disk.

## To bring bounced files back into tracks:

### 1 Do one of the following:

- If the newly bounced audio was automatically imported into the session, drag the new files from the Audio Regions List to existing tracks in your session.



*If you bounced from a selection point, you can snap the file to the bounce point: While pressing the Start key (Windows) or Control (Macintosh), drag the region from the Audio Regions List to the destination track.*

- If the bounced files are not available in the Audio Regions List, import them into the session by choosing File > Import Audio to Track, or drag and drop the bounced files from your DigiBase browser.
- If you are placing multiple files, keep channels time-aligned with each other by Shift-selecting them in the Regions List, and dragging them simultaneously into existing tracks of the right format.

**2** When working with stereo tracks, set the pan controls hard left and hard right.

**3** Mute or turn off the voices of original source tracks so that you don't double monitor your audio material.

**4** Click Play in the Transport window to hear the results of the bounce.

---

## Final Mixdown

In final mixdown, you create a mix that includes all your edits, automation, and effects processing.

### To bounce a final mix to disk:

**1** Adjust track output levels, finalize any mix automation, and choose an Automation mode for each track in the session.

**2** Adjust any real-time plug-in and effects settings and automation for each track in the session.

**3** Make sure that all of the tracks you want to include in the bounce are audible (not muted or inactive).

**4** Assign the output of each of the tracks you want to include in your bounce to the same output path.

**5** Do one of the following:

- To bounce the entire session, click Return to Zero in the Transport window to go to the beginning of the session.
- or –
- To bounce a portion of the session, enable Operations > Link Edit and Timeline Selection, and make a selection in the Edit window.

**6** Add dither. See “Dither and Bounce to Disk” on page 480.

**7** Choose File > Bounce to Disk.

**8** Choose the source path you want to bounce.

**9** Configure other Bounce to Disk settings as appropriate. See “Bounce Options” on page 483.

**10** Click Bounce.

**11** Select a destination for the new audio file, enter a name, and click Save.

---

## Mastering

In the final mastering process, you might record directly to disk, DAT, DVD, CD, stereo mastering recorder, or a multitrack recorder (for surround mixes).

Once you have created a master of your session, you can transfer it to a portable medium for duplication. You can transfer the master file to CD or DAT to be used as a master for pressing compact discs.

### Mastering to a Digital Recorder

Although it is usually best to master sessions directly to hard disk, Pro Tools also lets you master digitally, direct to any AES/EBU-equipped or S/PDIF-equipped digital recorder such as a DAT deck.

### 24-Bit Input and Output

Pro Tools TDM systems support full 24-bit audio input and output signal paths, with 48-bit internal mixing and processing, providing an additional 16 bits of headroom at the top of a channel's dynamic range, and 8 bits at the bottom. You can exchange files with other 24-bit recording systems without any bit-depth conversion (as long as they are in a compatible file format).

Pro Tools LE systems support 24-bit input and output, and uses 32-bit floating point mixing and processing internally.

### Mastering and Audio Compression

Although audio compression is often an indispensable tool in analog recording, it can present problems in the digital domain. If you compress an input signal at a very high ratio, you create a signal that contains a much higher overall power level compared to its transients. By re-

coding a number of such signals at the highest possible level on multiple tracks, you create a scenario that is more likely to clip the mixed output signal.

High-power compressed signals, when mixed together, create an extremely high-level output. This output may rise above the full-code level, resulting in clipping.

To avoid this problem, watch the overall level of your program material—use a meter on a Master Fader, or use an external mastering deck's meters to help avoid clipping. If you are mastering to hard disk, avoid mixing full-code audio signals together at unity or “0” level, as this invariably causes clipping.

### Mastering and Error-Correcting Media

Random access media (such as hard disks, optical cartridges, Bernoulli cartridges or WORM drives) can produce a true digital copy of your data, because every bit value is maintained. Sequential media (such as DAT tapes) use error correction schemes to fix the occasional bad data that is received in a digital transfer. These corrections are deviations from the actual data, and with successive reproductions, represent a subtle form of generation loss.

You can avoid this loss by creating and maintaining masters on random-access digital media (such as a hard drive) and transferring them to sequential digital media (such as DAT tapes) only as needed.

**To configure Pro Tools for direct digital stereo mastering:**

- 1** Connect your digital recorder to your system's digital outputs. If your system has multiple digital outputs, use channel 1 and 2 of the audio interface.
- 2** In Pro Tools, set the appropriate digital format and output from the Hardware Setup dialog or I/O Setup dialog. (See "Configuring Pro Tools Hardware Settings" on page 41.)
- 3** On your digital recorder, choose the appropriate digital format for the connections.
- 4** In Pro Tools, set all audio tracks you want to your master outputs 1–2 path.
- 5** Click Return to Zero in the Transport window to go to the beginning of the session.
- 6** Press Record on your digital recorder.
- 7** Start playback of your session.
- 8** When your session has finished playing, stop the digital recorder.

# Part VII: Surround





# Chapter 30: Surround Concepts

Pro Tools HD-series and MIX-series systems support multichannel mixing for surround sound.

## How to Use These Chapters

This part of the guide describes multichannel mixing for surround sound with Pro Tools. These sections supplement the basic Pro Tools information provided elsewhere in the *Pro Tools Reference Guide*.

If you are new to surround mixing, read the remaining sections of this chapter for an introduction to surround terminology and concepts.

If you already have experience with surround mixing, mastering, and monitoring, this chapter can be skipped. Operational instructions for Pro Tools surround features begin in Chapter 31, “Pro Tools Setup for Surround.”

---

## Mixing Formats and Surround Formats

When running Pro Tools version 5.1 or higher with the Surround Mixer plug-in, Pro Tools HD-series and MIX-series systems let you mix in 3- to 8-channel formats, in addition to standard mono and stereo.

Supported mixing formats include Mono, Stereo, LCR, Quad, LCRS, 5.0, 5.1, 6.0, 6.1, 7.0, and 7.1.

Surround formats include Dolby Surround (Pro Logic), Dolby Digital, DTS, and SDDS. Pro Tools does not provide its own surround format processing, and requires appropriate plug-ins (such as Dolby Surround Tools™) or hardware to provide Dolby surround encoding and decoding.

## Pro Tools Mixing Formats

 See also “5.1 Track Layouts, Routing, and Metering” on page 512.

Table 31. Multichannel Mixing and Surround Formats

Speaker Channels	Multichannel Mixing Format	Surround Format	Channels and Track Layout
1	Mono		C
2	Stereo		L R
3	LCR	Cinema Stereo	L C R
4	Quad	Quadraphonic	L R Lr Rr
4	LCRS	Dolby Surround (Pro Logic)	L C R S
6	5.1	Film (Pro Tools default), for Dolby Digital	L C R Ls Rs LFE
6	5.1	SMPTE/ITU (Control 24)	L R C LFE Ls Rs
6	5.1	DTS (ProControl)	L R Ls Rs C LFE
7	6.1	Dolby Surround EX	L C R Ls Cs Rs LFE
8	7.1	SDDS	L Lc C Rc R Ls Rs LFE

Legend: L = Left; R = Right; C = Center, S = surround (mono); Ls = Left Surround; Rs = Right Surround; Lc = Left Center; Rc = Right Center; Cs = Center Surround; Lr = Left Rear; Rr = Right Rear; LFE = Low Frequency Effects (handled by a sub-woofer or bass management systems)

## Speaker Layouts

Figure 33 on page 499 illustrates the speaker arrangements of each surround format. Speaker placement for each format is approximate. For proper placement, alignment, and calibration of surround monitoring systems, consult the documentation that came with your speakers and other monitoring equipment. Placement of speakers is crucial to accurate monitoring of any mix, but this is especially true with multichannel mixing for surround sound.

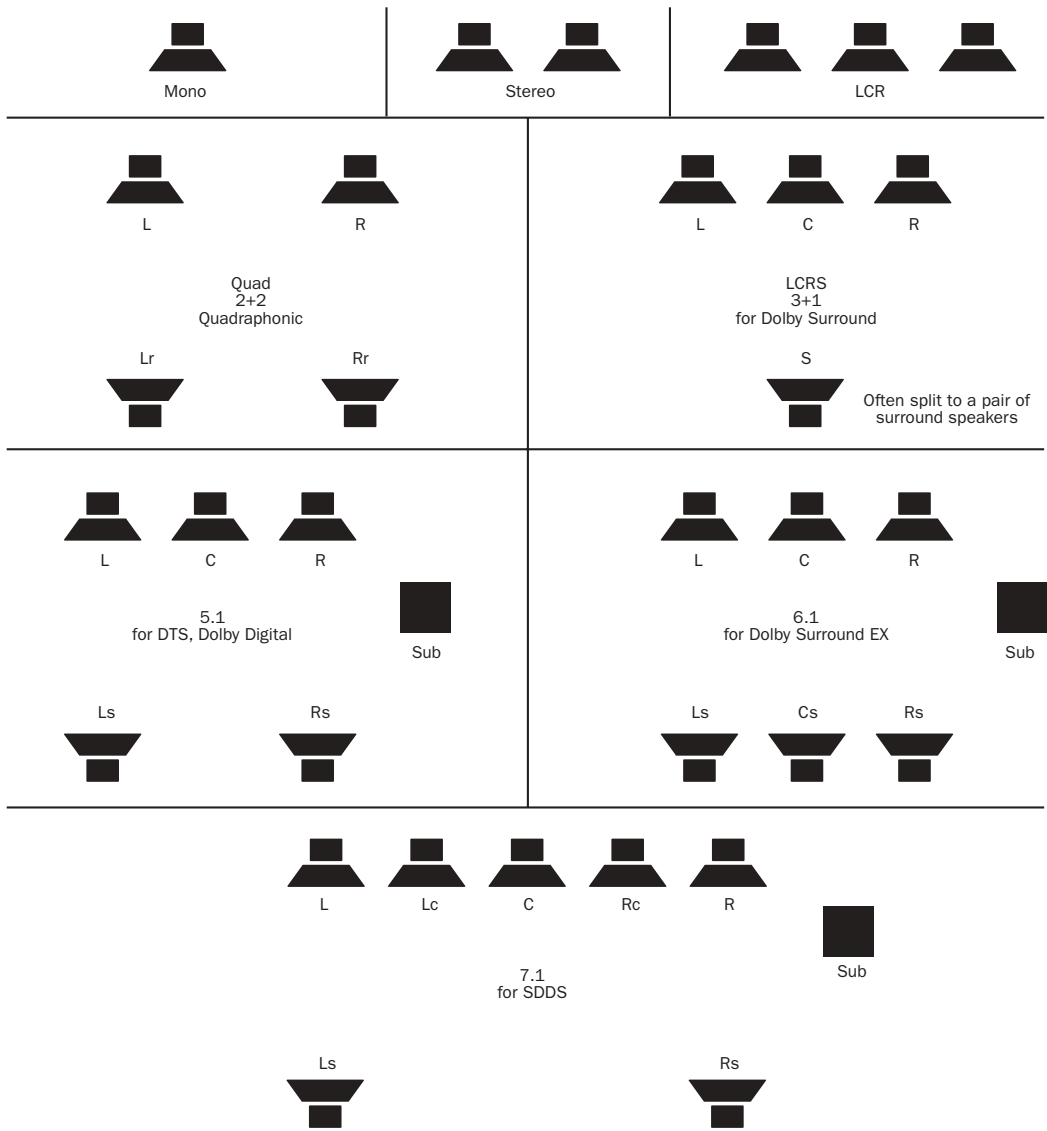

Figure 33. Speaker arrangement of surround formats

---

## Surround Monitoring

In order to monitor your current multichannel mix in a given surround format (such as DTS or Dolby Digital), encoding and decoding equipment for that format is required. Pro Tools does not provide direct support for surround format processing, but encoding/decoding hardware or software is available from Digidesign and third-party manufacturers. Contact Digidesign or your dealer for information.

Proper speaker placement, studio calibration, additional surround processors, monitors, and a properly calibrated system can lessen the variables that your mix will be subjected to when the audience eventually hears it in the theater, in their home, or elsewhere.

## The Importance of Speaker Placement

It is very important that your surround monitor system be installed and configured correctly. Proper speaker placement, angling, and level calibration are necessities for surround mixing, so consult the manufacturer of your monitor system. Several surround formats (especially all of those from Dolby as well as DTS) have very specific speaker and monitoring recommendations, so take the time to locate this information and adhere to the suggestions they provide.

For an example of a 5.1 monitor system, see Figure 34.

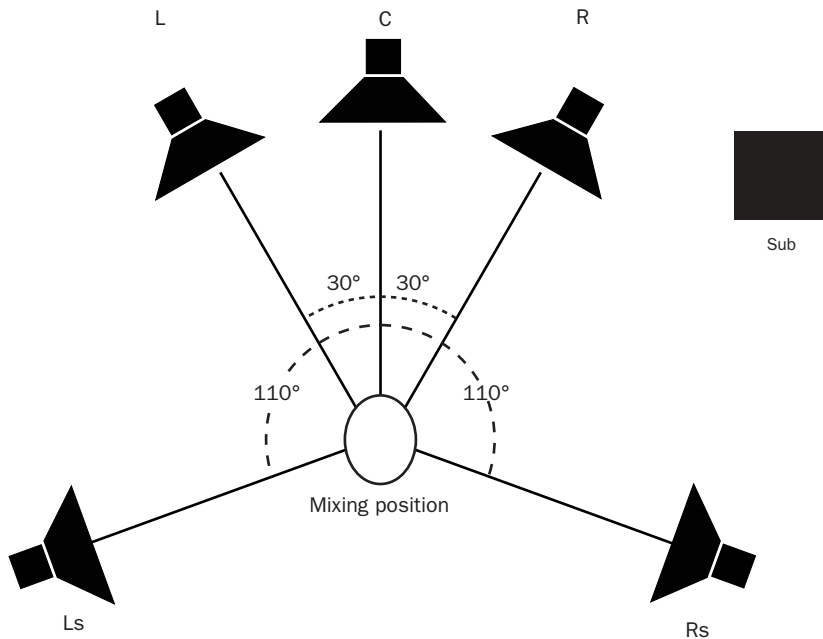

*Figure 34. Example of speaker arrangement for 5.1 mixing and monitoring (SMPTE specification). Sub placement is variable, while all other speakers should be as close to the suggested angles as possible.*

## Calibrated Surround Monitoring

One of the most important things you can do is to calibrate not only Pro Tools, but also your monitoring system and other equipment.

For example, many post production facilities calibrate their Pro Tools audio interfaces for  $-20\text{ dB} = 0\text{ VU}$ . Once Pro Tools hardware has been calibrated to unity gain, the monitoring system can be adjusted to account for anomalies in the room acoustics, speaker placement, and other variables.

Calibrating your Pro Tools system involves attenuating the input and output stages of your system. Settings and reference level vary according to the applicable standards of the current project.

 *Instructions for calibrating a Pro Tools 192 I/O audio interface are included with the 192 I/O documentation.*

**Calibrating Your Studio** The first task for surround mixing should be getting your monitor speakers in proper position, alignment and calibration for accurate listening and mixing.

Speaker position and alignment will vary according to each installation, and is very specific for different speakers, manufacturers, and for each surround format. Instructions for optimal speaker location should have been provided with the speaker and monitor system, so consult the documentation provided by its manufacturer.

Proper speaker calibration ensures that your system plays back at accurately balanced levels. This lets you compensate for any variances in speaker position, alignment, or performance.

---

## Formats and Terminology

Some multichannel mixing formats are referred to numerically (such as 5.1 and 7.1). These numbers describe the number and type of output (speaker) channels required for that format. Other formats are referred to by their track layout (such as LCRS and LCR).

Surround formats are referred to by their developer and product name, such as Dolby Surround (or Pro Logic), Dolby Digital, DTS, Dolby Surround EX, and others. Each surround format requires you to mix in a compatible mixing format. For example, both Dolby Digital and DTS are “5.1 surround formats.”

The standards for each format include more than just the number of speakers. Formats also may require specific track layout and filtering for the various channels. For example, the surround channel in Dolby Surround is band limited from 100 Hz to 7 kHz.

Surround formats also increase the importance of phase, balance, and sound placement due to the various ways in which multichannel mixes can be encoded, decoded, compressed, matrixed, or downmixed. Many publications are available on these subjects. For a listing of several sources of surround format information, see “Where to Get More Information on Surround Technology” on page 504.

## LCRS for Dolby Surround

Dolby Surround (Pro Logic) is a four-channel format that is one of the most widely installed consumer surround formats.

This format, which requires Dolby encoding and decoding technology, provides three full-range front speakers left, center, and right, plus a mono surround channel (often split and monitored through pairs of satellite speakers, but a single “rear” channel nonetheless).

### Surround Format Example

The goal of Dolby Surround encoding is to make a four-channel mix (LCRS) more portable, by transforming it into an encoded two-channel mix referred to as Lt/Rt. Lt and Rt represent Left Total and Right Total, respectively. Whenever you see Lt/Rt, it refers specifically to material that has been processed by a Dolby Surround Encoder (such as the Dolby SEU4 or Dolby Surround Tools plug-in).

The Lt/Rt mix can then be transported, transmitted, or played as a stereo mix, making it compatible with most home and theater systems. Alternately, the Lt/Rt pair can be decoded back into an LCRS mix in home theater systems where the required decoding hardware is available.

**⚠** *For professional results, always use professional-level products (such as the Dolby Model SDU4 Decoder, Model DP564 Decoder, or Dolby Surround Tools plug-in) when mix monitoring. Pro Logic-equipped consumer products have auto-balancing features which, if used for mix monitoring, may contribute to inappropriate mixing decisions*

## 5.1 for Dolby Digital and DTS

Both Dolby Digital and DTS formats are six-channel, 5.1 formats. Both provide five full-range speakers and a sub. These two surround formats use different track layouts, filtering, and compression as part of their specifications.

### .1 Formats

The “.1” in any multichannel mix format indicates an LFE (Low Frequency Effects) track in the mix. Whenever a decimal is part of a surround format, it indicates a discrete *Sub* channel in the surround playback system that is intended for playback through a subwoofer speaker. For example, Dolby Digital is a 5.1 format intended for playback through systems with five full-range speakers and one subwoofer speaker. Dolby Surround EX is a 6.1 format, with six full-range speakers and one subwoofer speaker. SDDS is a 7.1 format, with seven full-range speakers and one subwoofer speaker.

Sub content will include the LFE channel of a “.1” format mix, as well as the effects of any bass management in the playback system. See “LFE” on page 503.

### .0 Formats

The “.0” formats (5.0, 6.0, 7.0), while not associated with any specific surround formats, are useful in many mixes as sub-paths. For example, not all tracks will have content that needs to be routed to the LFE channel (the “.1” channel). Assigning such tracks to a 5.0 path provides a 360° panner without LFE controls.

## LFE

When a decimal such as “.1” is present in the name of a surround format, it indicates the presence of an LFE channel. The LFE channel (for Low Frequency Effects, also known as Low Frequency Enhancement) refers most often to a specific track used in *production* (not during playback or decoding). LFE is the “.1” component in mix formats such as 5.1 and 7.1.

The reason the LFE component is referred to as “.1” is that unlike the other five or seven speakers, LFE is not full bandwidth (or full-range). The LFE signal provides a discrete path for low end to the subwoofer, unaffected by bass management (if any). Low frequency effects include such things as thunder, explosions, and other bass effects.

LFE is generally used to enhance sound effects in films. There are no set rules about whether or not you must employ an LFE channel.

**▲** *Pro Tools applies no filtering to LFE signals. Some delivery requirements may require filtering for the LFE track. See “Mixing Formats and Surround Formats” on page 497 for more information.*

## Sub Content

When surround mixes are played back on systems that include one or more subs, subwoofer content comes from either or both of the following sources:

- All bass from all channels that is below the threshold of the bass management filter cut-off (if any)  
– and –
- Audio in the LFE channel (if any)

A surround sub will play back all the lowest-frequency sounds from all of the other speaker channels, below a fixed frequency threshold. The threshold varies among different surround formats. See “Where to Get More Information on Surround Technology” on page 504 for a list of surround specification resources.

In addition to the frequency cutoffs and other specifications of each surround format, playback system variables can affect sub content. See “Surround Playback System Variables” on page 505 for more information.

## Divergence

Divergence is a surround mixing control that lets you set panning “width.” Full divergence results in discrete (or narrow) panning. Lower divergence settings result in progressively less discrete (or wider) panning.

With Full (100%) divergence, tracks can be panned exclusively, or discretely, to a single speaker. Sounds panned to a single speaker are only audible in that speaker.

When divergence is less than 100%, tracks will be audible in neighboring speakers even when panned directly to a single speaker in the grid. Lower divergence settings result in a progressively wider source signal.

## Divergence Example

To understand divergence, it can be helpful to imagine the inside of a large movie theater. This is a good example because one of the most challenging playback variables one faces in multi-channel mixing is the size of the intended listening environment.

Unlike the typical living room, movie theaters are large spaces with speakers placed widely apart. Due to distance, sounds panned discretely to the front right speaker, for example, might be inaudible in the opposite corner. To avoid this problem, variable divergence lets you control the panning width, in order to widen the sound source. This results in signals spreading into adjacent speakers, even when panned 100% to an individual speaker.

 *Divergence options in Pro Tools are explained in "Divergence" on page 534.*

## Where to Get More Information on Surround Technology

The table below lists several sites that are good starting points for your research into the constantly evolving world of surround sound production.

### Resources for surround specifications and information

Surround Specifications	Web Site
Dolby Surround/Pro Logic	<a href="http://www.dolby.com">www.dolby.com</a>
Dolby Digital	<a href="http://www.dolby.com">www.dolby.com</a>
Dolby Surround EX	<a href="http://www.dolby.com">www.dolby.com</a>
DTS	<a href="http://www.dtsonline.com">www.dtsonline.com</a>
SDDS	<a href="http://www.sony.com">www.sony.com</a>
THX	<a href="http://www.thx.com">www.thx.com</a>

---

## Surround Mixing Concepts

As in stereo mixing and mastering, the goal in surround mixing is to provide the best sounding mix to the greatest number of potential listeners. Doing so for surround mixes requires many of the same techniques used for professional stereo production, plus several unique factors that are introduced in the following sections.

## Surround Format Compatibility

Pro Tools lets you mix in surround and create multichannel masters, consisting of four, six, or more tracks that comprise an LCR, 5.1, or other format mix.

- ◆ Whenever necessary, multichannel mixes can be transferred as discrete, unencoded, multi-track masters. Track layout requirements vary by format (see "Importing Multichannel I/O Setups" on page 510 for more information).
- ◆ Consumer playback systems don't necessarily support every format. *Downmixing* occurs when a specific format mix has to be created from another. (A typical example of this is listening to a DVD's 5.1 Dolby Digital soundtrack downmixed to stereo.)

To anticipate the effects of surround encode and decode, as well as potential downmixing, professional surround mixes are monitored through appropriate encoding and decoding processors. Monitor controller systems let engineers hear their mix through different speakers and configurations for reference, as well as compare factors such as different bass management settings and their effect.



## Surround Formats and Delivery Mediums

Surround mixes are tailored for their specific delivery medium. Most often, this requires format-specific encode and decode processing.



*Some delivery media on which surround formats are distributed may have additional audio constraints, which could influence your work flow in Pro Tools. Dolby Digital audio on a DVD-Video disc, for example, requires a 48 kHz sampling rate. If your Pro Tools session isn't at 48 kHz, you must sample rate convert the audio before encoding it with Dolby Digital for DVD.*

### Encoding and Decoding

Many surround formats utilize some form of encoding and decoding to make it practical to deliver, broadcast, and transfer the multiple channels of full-bandwidth audio they require.

- ◆ *Encoding* is the process necessary to make multichannel mixes portable and playable. In many cases, this involves taking the four, five, six, or more discrete channels resulting from a multichannel mix and converting them into a two-channel stream for broadcast (still a predominantly 2-channel medium).
- ◆ *Decoding* is the process needed to reproduce (or unfold) the discrete surround channels from a 2-channel delivery medium.

Both encoding and decoding, no matter how refined, represent additional processing stages applied to your mix before it reaches its ultimate destination, the audience.

For example, because the Dolby Surround algorithm depends heavily on phase relationships, there is always a significant difference in a decoded LCRS output as compared to the original

LCRS mix. To account for these anomalies, engineers mixing for Dolby Surround listen through hardware encode and decode processors for reference.

Professional mixing and mastering engineers use encoders and decoders to precisely audition the effect of the encoding and decoding process, and make any adjustments necessary.

### Surround Processing and Pro Tools

Pro Tools requires additional software or hardware for surround encoding, decoding, and processing. For example, the Dolby Surround Tools™ plug-in lets you monitor and process completely within the Pro Tools environment.

Surround Tools and other surround processing solutions are available from Digidesign and third party manufacturers. Contact your Digidesign Dealer for more information.

### Surround Playback System Variables

Different playback systems for surround sound introduce varying amounts and types of filtering, bass management, and other variables. These include the specifications for certain surround formats, as well as options to fine-tune a system for its particular installation.

In your own studio, you know what speakers you are listening to, what their qualities are, and what your control room sounds like. What is impossible to know, however, is what speakers are in the living room, theater, or concert hall where your mix will be heard by an audience.

## Bass Management

Bass management is a function of the playback system. Bass management refers to a number of processes by which a playback system can control what will be heard through the Sub(woofer) and other channels. The purpose of bass management is to optimize low frequency reproduction and overall frequency response for your specific monitoring system. Bass management provides a way to tune bass response for variables, including room size and shape, the presence (or absence) of a subwoofer, and the frequency range of each speaker.

### Filtering

In its simplest form, bass management applies high-pass filtering to the full-range speakers. Frequencies below the filter cutoff are summed with the LFE channel (if present) and then routed to the subwoofer. Different systems may offer additional bass management processes, including:

**Bass Redirection** Mutes or unmutes the low-frequency signals filtered out of the full-range channels (all signals that fall below the bass management filter cutoff frequency). This is useful when the full-range speakers are truly full-range, capable of accurately reproducing bass without distorting.

**Bass Extension** Allows the bass (however it is derived) to be routed back through the full-range speakers. Though this may seem like a contradiction, its main purpose is to let sub content emanate from all around, rather than only from the subwoofer.

# Chapter 31: Pro Tools Setup for Surround

This chapter explains how to set up and configure Pro Tools sessions for multichannel mixing.

Multichannel mixing is supported on Pro Tools HD-series and MIX-series systems only. In this chapter, all references to Pro Tools refer to Pro Tools HD-series and MIX-series systems.

## Before you can use Pro Tools in Surround mode:

- 1 Make sure the Surround Mixer plug-in is installed in your Plug-Ins folder. If it is not, it can be installed using your Pro Tools Installer CD-ROM. For details on installing Pro Tools options from the Pro Tools Installer CD-ROM, see your *Getting Started Guide*.
- 2 Make sure your audio hardware is connected to your monitor system and other equipment correctly.
- 3 Make sure you have configured the Pro Tools Playback Engine and Hardware Setup dialog options correctly for your system as described in your *Getting Started Guide*.
- 4 Continue reading this chapter to learn how to configure Pro Tools and your sessions for Surround mode.

## Pro Tools Audio Connections for 5.1 Mixing

While all 5.1 mixing formats provide the same speaker arrangement, there are three primary standards in use for the track layout of the individual channels that comprise the 5.1-format multichannel mix.

In the following table, it is assumed that surround channels are mapped to outputs 1–6 of a Pro Tools audio interface. Use channels 7–8 to monitor a stereo mix for a stereo version, or for cue mixes and monitoring.

Table 32. Track Layouts for 5.1 Formats

Formats	Track Layout					
	1	2	3	4	5	6
Film (Pro Tools default)	L	C	R	Ls	Rs	LFE
SMPTE/ITU for Dolby Digital (AC3) and Control 24	L	R	C	LFE	Ls	Rs
DTS with ProControl	L	R	Ls	Rs	C	LFE

### **To connect your audio interfaces for 5.1 format mixing and monitoring:**

- 1 Determine the 5.1 format and track layout you want to use.
- 2 Connect the output channels of your audio interface to the corresponding input channels of your monitoring system according to the assignments listed in Table 32 on page 507.

 *If you use a Digidesign control surface, see its guide for more information.*

---

## **Configuring Pro Tools for Multichannel Sessions**

Configuring Pro Tools and sessions for multichannel mixing can be done in any, or all of the ways, as described in this section.

 *The Surround Mixer must be installed before you can use Pro Tools surround mixing features. Make sure the Surround Mixer plug-in is installed in your Plug-Ins folder. If it is not, it can be installed using your Pro Tools Installer CD-ROM. For details on installing Pro Tools options from the Pro Tools Installer CD-ROM, see your Getting Started Guide.*

### **New Sessions**

You can create a new session and choose a surround mix I/O Settings file as the *default* I/O Setup. (See “New Sessions and I/O Settings” on page 508.)

### **Remixing Sessions in Surround**

By creating or importing a surround mix I/O Settings file in the I/O Setup dialog, multichannel paths can be made available in any stereo (or other format) session. You can then reassign

track routing from the original stereo paths to multichannel paths. Inactive and active paths simplify reassignment. (See “Importing Multichannel I/O Setups” on page 510.)

### **Custom Paths**

You can customize and redefine existing paths in the I/O Setup dialog. For more information, see “Custom Multichannel Paths” on page 510.

### **Importing Session Data**

By using the Import Session Data command (File > Import Session Data), you can import tracks and media from other sessions plus their associated paths and track assignments. After importing session data, you can use the I/O Setup dialog to configure main and sub-paths for the requirements of the session. For more information see “Imports any Pro Tools mic preamplifier settings from the source session. Any mic preamplifier settings in the destination session are replaced.” on page 121.

### **New Sessions and I/O Settings**

When you create a new session, you can specify a surround format that you want to use as your I/O Setup. Default path configurations are provided as I/O Settings files, for stereo and surround mixing.

Once you create the new session, you can create and import tracks, import audio, and assign signal routing to set up your mix.

**To create a new session for multichannel mixing:**

1. Choose File > New Session.
2. Select one of the available 5.1 settings from the Default I/O Settings menu.

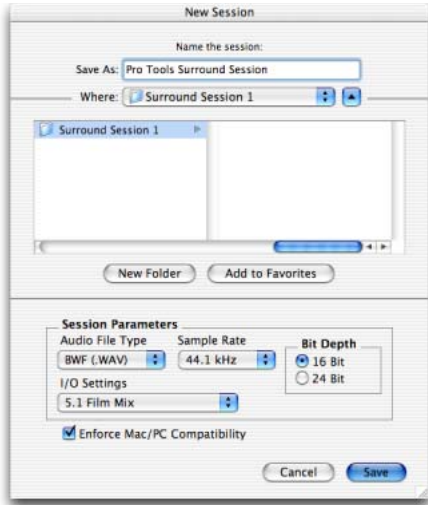

**Configuring a new session for a 5.1 mix**

The surround presets preconfigure the I/O Setup dialog with default 5.1 format main and sub-paths for outputs and busses.

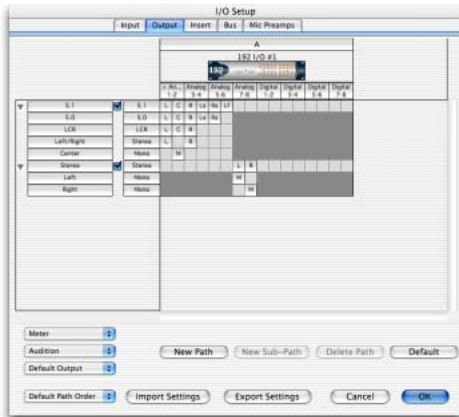

*Standard 5.1 format (film) output paths*

**Surround Mix Settings Files**

The surround mix I/O Settings files provide output and bus paths for three specific track layout standards. (For information on inputs and insert paths, see “Default Input and Insert Paths with 5.1 Settings” on page 509.)

**Settings Files and Track Layouts**

5.1 Settings	Track Layout
Film (Pro Tools Standard)	L C R Ls Rs LFE
SMPTE/ITU (Control 24 Monitoring)	L R C LFE Ls Rs
DTS (ProControl Monitoring)	L R Ls Rs C LFE

All three 5.1 format settings files provide the following default output and bus paths:

**Default 5.1 Output Paths**

- One 5.1 main output path, with sub-paths for center, left/right, LCR, and 5.0 (no LFE). – and –
- One stereo main path with two mono sub-paths.

**Default 5.1 Bus Paths**

- One 5.1 main bus path, with sub-paths for 5.0 (no LFE), left/right (stereo), LCR, and center (mono). – and –
- One stereo main path with two mono sub-paths.

**Default Input and Insert Paths with 5.1 Settings**

The 5.1 Mix settings files provide default stereo main and sub-paths for inputs and inserts. If you need multichannel input paths or inserts, you can create them in the I/O Setup dialog (see “Custom Multichannel Paths” on page 510).

## Importing Multichannel I/O Setups

The I/O Setup dialog can import and export settings files. Importing I/O Setup settings files is useful when you want to remix a stereo session in surround. You can also use this feature to prepare a session for transfer to a different Pro Tools system, or to simply save and exchange I/O Settings.

### To import a multichannel I/O Setup settings file:

- 1 Choose Setups > I/O Setup.
- 2 Click Import Settings.
- 3 Select the settings file to import.

If the current session has existing path definitions that don't match those in the imported settings file, Pro Tools asks whether you want to delete the existing paths or retain them and add the imported settings to your session.

- Click No to add new paths to your current I/O Setup configuration.
- Click Yes to replace your current I/O Setup configuration with the imported settings.

## Exporting I/O Settings

Exporting I/O Setup settings files lets you build a library of multichannel setups for different projects.

### To export an I/O Setup settings file:

- 1 Choose Setups > I/O Setup.
- 2 Click Export Settings.
- 3 Name and Save your current I/O Settings.

## Custom Multichannel Paths

The I/O Setup dialog lets you create and customize signal paths for any supported multichannel mixing format.

Multichannel paths and sub-paths are mapped to inputs, outputs or internal busses in the Channel Grid. When you select a preset 5.1 I/O Settings file, default layout for the corresponding multichannel format paths you create will match the selected format's track layout.

In addition, the I/O Setup dialog, like the Main page of the Hardware Setup dialog, provides controls for routing the physical inputs and outputs on your audio interface to available inputs and outputs in Pro Tools.



*When creating 5.1 format paths, you can specify the default track layout. See "Default Path Order for 5.1 Tracks" on page 512.*

## Remapping Channels

The I/O Setup dialog and its Channel Grid also let you remap channels. This is especially useful to route channels within a multichannel path, without having to repatch your audio interfaces.

You can remap paths to any required configuration, limited only by your systems resources, and the I/O Setup dialog requirements for channel overlapping and naming (see “Valid Paths and Requirements” on page 77 for more information).

 See also “Example Paths and Signal Routing for a Surround Mix” on page 521.

### Example LCRS Setup

The following example shows one possible way to configure the I/O Setup dialog to mix in 4-channel LCRS format, with a 96 I/O.

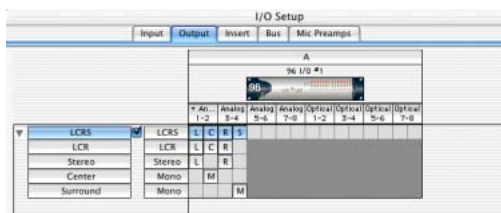

**Example LCRS output main and sub-paths**

 For additional I/O Setup information, see “Creating and Editing Paths” on page 73.

### To define an LCRS path:

- 1 Choose Setups > I/O Setup > Output.
- 2 Click New Path.
- 3 Select LCRS from the Path Format Selector.
- 4 Name the path LCRS.
- 5 In the Channel Grid, click in the box below the first (left-most) audio interface channel for the path. Pro Tools automatically fills up the adjacent units to the right. If you click in the LCRS row under channel 1, the LCRS path will be mapped across channels 1–4.
- 6 Select the new LCRS path and click New Sub-Path.

**7** Name the new sub-path LCR and select LCR as the Path format. Click in channel 1 in the LCR row to map the path.

**8** Select the LCRS path, click New Sub-Path, and create a stereo sub-path for front Left and front Right.

**9** Select the LCRS path, click New Sub-Path, and create a mono sub-path for the Center channel.

**10** Select the LCRS path, click New Sub-Path, and create a mono sub-path for the Surround channel.

## 5.1 Tracks, Formats, Mapping, and Metering

Path definitions in I/O Setup determine how audio is routed through, and metered on, your audio interfaces.

Pro Tools internal (on-screen) metering of 5.1 format paths always follows the Film track layout:

L C R Ls Rs LFE

Pro Tools track layout of 5.1 format audio tracks in the Edit window also conforms to the Film layout (arranged top to bottom). See the illustration “5.1 Track Layouts, Routing, and Metering” on page 512.

In the I/O Setup dialog, you can route these signals out of your audio interfaces according to any track layout (such as DTS, or SMPTE/ITU).

### To re-map channels in a path:

- Click and drag a channel to a new valid location in the Grid. Other channel assignments will move (shuffle) to accommodate dragged channels.

## Default I/O Selectors in I/O Setup

The Output tab of the I/O Setup dialog provides the following default settings for multichannel sessions:



I/O Setup Options and Default Path Order

### Default Selectors in the I/O Setup dialog

**Meter** Selects the path that will be shown in Digidesign control surface output meters. See “5.1 Tracks, Formats, Mapping, and Metering” on page 511 for more information.

**Audition** Selects the monitoring path for previewing audio in the Regions List, Import Audio dialogs, and DigiBase. Only outputs on your primary interface can be used as your Audition path.

**Default Output** Selects the default output path for all new tracks, for each supported track format.

**Default Path Order** Selects the default track layout (or, path order) for new 5.1 format (six-channel) paths.

## Default Path Order for 5.1 Tracks

You can specify the default track layout for all new 5.1 format paths you create.

### To choose a new default Pro Tools 5.1-format path order (track layout):

- 1 Choose **Setups > I/O Setup**.
- 2 Use the **Default Path Order** menu and sub-menus to choose the track layout you want.

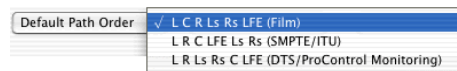

Default Path Order Selector in I/O Setup

## 5.1 Track Layouts, Routing, and Metering

5.1 Format	Tracks	Track Meters	Channel Map in I/O Setup
Film (Pro Tools Standard) L C R Ls Rs LFE			
SMPTE/ITU (Control)24 Monitoring L R C LFE Ls Rs	same L C R Ls Rs LFE (top to bottom)	same L C R Ls Rs LFE (left to right)	
DTS (ProControl Monitoring) L R Ls Rs C LFE	same L C R Ls Rs LFE	same L C R Ls Rs LFE	

Figure 35. Track layout of different 5.1 formats



# Chapter 32: Multichannel Tracks and Signal Routing

Surround sessions typically include a combination of mono, stereo, and multichannel audio tracks, Auxiliary Inputs, Master Faders, busses, and inserts.

Once the appropriate I/O Setup has been imported or configured, any audio track can be mixed in multichannel for surround using Pro Tools mixing features.

Multichannel I/O and signal routing is determined by the paths defined in the I/O Setup dialog.

---

## Multichannel Quick Start

The following is an overview of how to get started mixing in multichannel for surround in Pro Tools.

### To mix in multichannel:

- 1 Make sure the Surround Mixer plug-in is installed in your Plug-Ins folder. If it is not, it can be installed using your Pro Tools Installer CD-ROM. For details on installing Pro Tools options from the Pro Tools Installer CD-ROM, see your *Getting Started Guide*.
- 2 Open any stereo Pro Tools session to remix it in surround. (You can also create new, empty surround sessions. See “New Sessions and I/O Settings” on page 508.)
- 3 Configure the I/O Setup dialog with multichannel inputs, outputs, busses, and inserts, as needed. (See “Configuring Pro Tools for Multichannel Sessions” on page 508.)
- 4 Do one of the following:
  - Create new tracks, and assign track outputs and sends to your multichannel paths. Configure signal routing as needed for submixing, bussing, processing, and monitoring. For tracks that do not need to be panned in 360°, place them in the mix using sub-paths and signal routing. (See “Multichannel Signal Routing” on page 516.)
  - Use the Import Tracks command to import multichannel tracks.
  - Use the Import Session Data command (Pro Tools 6.x only) to import existing 5.1 tracks, busses, and other data. (See “Importing Tracks and Track Attributes” on page 114.)
- 5 Pan in surround using the multichannel Track Output and Send windows. (For information on mixing and panning for surround, see Chapter 33, “Surround Panning and Mixing.”)

---

## Multichannel Audio Tracks

Multichannel audio tracks contain an individual channel for each signal in the track (for example, a 5.1 track would have six channels for left, center, right, left surround, right surround, and LFE).

Multichannel audio tracks can be:

- Recorded directly into Pro Tools, using multiple microphones or microphone arrays, or routed to appropriate multichannel Pro Tools Input paths
- Imported from other Pro Tools sessions
- Edited, processed, and mixed in combination with mono and stereo tracks

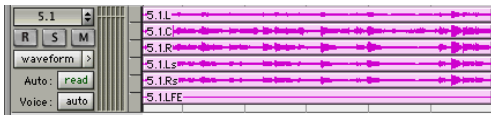

### 5.1 format multichannel audio track

5.1 format audio files and tracks conform to the Film track layout standard. Regardless of path mapping in the I/O Setup dialog, all 5.1 format audio tracks and meters follow the Film standard track layout:

L C R Ls Rs LFE

Multichannel audio tracks are not required to mix in multichannel formats. Mono, stereo, and all supported track formats can be mixed using Pro Tools track outputs and sends. See “Multichannel Signal Routing” on page 516.

## Placing Audio in Multichannel Tracks

You can drag audio files and regions from the Audio Regions List, or from other tracks, to place them in multichannel audio tracks.

To do so, the number of channels being dragged must match the destination track format. For example, you can only drag a stereo pair or two mono regions onto a stereo audio track. Similarly, you can only place audio into an LCR track when you have selected three regions. With 5.1 tracks, you must select six mono files or regions.

**⚠** *When dragged into a multichannel track, audio files are placed from top to bottom in the exact order that they appear in the Regions List or playlist from which they came. For this reason, you may want to rename audio files before dragging them, so that they are in a preferred order. Rename them so that sorting them By Region Name in the Regions List results in the preferred order. (For example, with a 5.1-format track, you can rename the audio tracks, so that the arrangement of the tracks corresponds to L, C, R, Ls, Rs, and LFE.)*

## Solo, Mute, and Gain in Multichannel Tracks and Paths

Stereo and multichannel tracks consist of multiple audio signals, linked together. By default, multichannel tracks are linked and are controlled by a single channel fader, solo and mute switch.

For discrete control of signals, multichannel tracks can be converted into individual mono tracks. For discrete level and phase adjustment, you can insert and unlink a multi-mono Trim plug-in. Both of these techniques are explained below.

**⚠** *Once converted to mono, multichannel tracks cannot be relinked into their original multichannel format. However, a multichannel track can be reassembled by dragging the corresponding number of mono files into a multichannel track, although some automation data will be lost. As an alternative, record the submix of the mono tracks to disk on a multichannel track.*

**To convert a multichannel track into discrete mono tracks:**

- 1 Select the multichannel track.
- 2 Choose File > Split Selected Tracks to Mono.

**To have discrete control of gain on individual channels of a multichannel track:**

- 1 Insert a multi-mono Trim plug-in on the multichannel track.
- 2 Unlink the Trim plug-in by clicking the Link icon so that it is unlit.
- 3 Use the Channel Selector to display the controls for a channel, and adjust the gain.

 See “Linking and Unlinking Controls on Multi-Mono Plug-Ins” on page 518 for more information.

## Track and Output Formats

When you create new tracks, you specify mono, stereo, or a supported multichannel format for the new tracks.

In the Mix and Edit windows, the track format of a track’s output is always visible by the number of track meters contained in its fader strip (for example, a single meter for mono tracks, a pair of meters for stereo tracks, and six meters for 5.1 tracks).

Assigning track output determines the format of that output. For example, a mono track always has a single track meter, even when assigned to a stereo output path. If that same mono track is assigned to a 5.1 output path, its output will be split among those six output channels, depending on the position of its panner.

### Changing Format

Changing the output format for a given track has several effects:

- The panner that appears in the track will change to reflect the new output format.
- It may be necessary for one or more panned automation playlists to be created or deleted.

Because changing the output format has these effects, a warning dialog appears whenever you change the output format of a track to a format of fewer channels. Specifically, this will occur whenever automation playlists will have to be deleted.

## Multiple Output Assignments and Track Format

When a track is assigned to more than one path of differing formats, the main output for that track will match the format of the assigned path with the greatest number of channels.

### Multiple Outputs and Automation Playlists

When a track has multiple output assignments, Pro Tools sorts panning data appropriately for each assigned path. For example, if you assign a mono track to a stereo path and a 5.1 path simultaneously, that track will have a 5.1 panner in the Mix or Edit window. When you pan the track, Pro Tools interprets the 5.1 panning moves into stereo panning moves.

This provides a type of parallel mixing. You can create a variety of mixes of differing formats all at the same time by routing your elements to multiple paths.

 *Control-Start-click (Windows) or Command-Control-click (Macintosh) any control in an Output window to show its automation playlist in the Edit window and view any pan automation.*

## Multichannel Signal Routing

To mix in a multichannel format, tracks are assigned to multichannel paths.

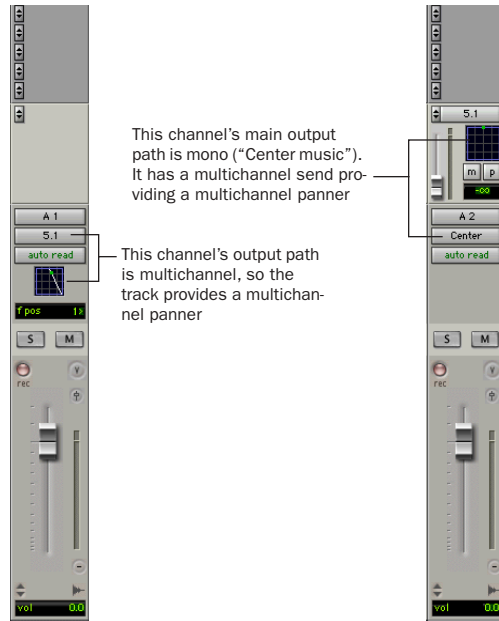

**Two different ways to configure tracks for multichannel mixing**

Tracks can be mixed in surround using the following two methods:

- By setting a track main output to a multichannel path.
- By assigning a multichannel send to route audio to a multichannel path.

 See “Multichannel Sends” on page 517 for more information.

## Multichannel Track Outputs

Tracks can be routed to multichannel output or bus paths using the track Output Selector. This provides a multichannel panner and meter in the Mix and Edit window I/O View.

Additional output assignments can be added by Start-clicking (Windows) or Control-clicking (Macintosh) the Selector and assigning another path.

## Multichannel Sends

All track formats, including mono and stereo, let you assign one or more multichannel sends. This provides a multichannel panner in the Sends View. Sends are also useful to bus tracks for multichannel plug-in processing.

Figure 36 shows a mono audio track with a 6-channel send (Sends View Shows > Send A View).

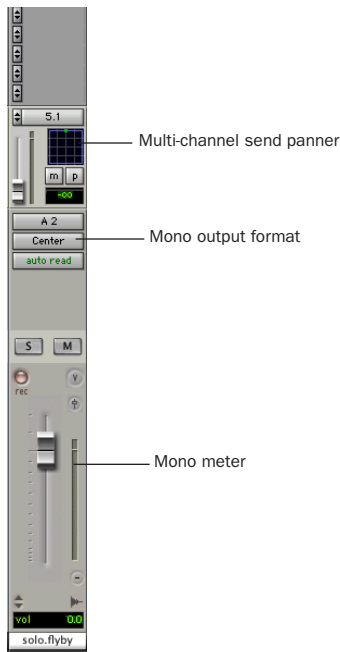

Figure 36. A mono audio track with a mono output format, with a multi-channel send

Pro Tools bussing and submixing features are available for all channel formats, from mono/stereo through 8-channel. For examples of multichannel monitoring, effects processing, and bussing, see “Mixing with Paths and Sub-Paths” on page 519. For mono and stereo mix examples, see Chapter 26, “Basic Mixing.”

## Multichannel Auxiliary Inputs and Master Faders

A multichannel Auxiliary Input or Master Fader is used as a return for the multichannel bus. Sends are useful when you need to create an additional, independent mix simultaneously (perhaps of a distinct format), requiring dedicated fader, mute, solo, and automation controls.

You can assign Master Faders to main and sub-paths. Main paths must match the format of the Master Fader, and only one Master Fader can be active and assigned to any single (active) main or sub-path. A Master Fader cannot be assigned to a sub-path if its associated main path is already assigned on another Master Fader. See “Master Faders” on page 406.

## Mono, Multi-Mono and Multichannel Plug-Ins

Plug-ins can be used in mono, multi-mono, or multichannel formats.

<input checked="" type="checkbox"/>	no insert	
	multi-channel TDM plug-in	▶
	multi-channel RTAS plug-in	▶
	multi-mono TDM plug-in	▶
	multi-mono RTAS plug-in	▶
	i/o	▶

### Plug-in formats

For information about mono, stereo, and mono-in/stereo-out plug-ins, see Chapter 27, “Plug-In and Hardware Inserts.”

**Multi-Mono Plug-Ins** Are designed for use on stereo or greater-than-stereo multichannel tracks. Multi-mono plug-ins are useful, or required, in the following situations:

- When a plug-in does not involve multichannel correlated processing (for example, when applying EQ to select sides of a multichannel signal)
- When you need to adjust signals within the multichannel track independently
- When a plug-in does not support multichannel formats

When a multi-mono plug-in is first inserted on a multichannel track, the plug-in controls are linked. You can unlink them for independent adjustment. See “Linking and Unlinking Controls on Multi-Mono Plug-Ins” on page 518 for more information.

Multi-mono plug-ins can also be inserted on stereo tracks, to apply unlinked plug-ins on the left and right channels.

**Multichannel Plug-Ins** Are designed for use on stereo and multichannel tracks that require correlated processing, including stereo and multichannel limiting, compression, and similar effects.

### Linking and Unlinking Controls on Multi-Mono Plug-Ins

When a multi-mono plug-in is used on a multichannel track of more than two channels, the controls are normally linked. Adjusting the Gain control on one channel, for example, will adjust it for all channels.

If necessary, you can unlink plug-in controls on specific channels of a track and edit them independently. You can also selectively link the controls of specific channels.

For example, to apply equal filter cutoffs to the Ls and Rs (surround) channels in a 5.1 mix, you could link enable just those channels in an unlinked, multi-mono EQ plug-in. Adjusting the controls in the plug-in window for either channel (Ls or Rs) adjusts the other, linked channel as well.

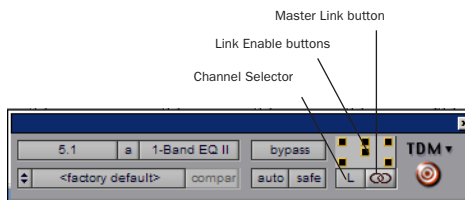

*Channel Selector and Link controls*

**Channel Selector** Accesses a specific channel within a multichannel track for plug-in parameter editing. This menu appears only on multi-mono plug-ins inserted on tracks with more than two channels.

**Master Link Button** When enabled, links the controls on all channels of a multi-mono plug-in so that they can be adjusted in tandem.

**Link Enable Buttons** Let you selectively link the controls of specific channels of a multi-mono plug-in. Each square represents a speaker channel. The Master Link button must be disabled to use the Link Enable buttons.

#### To unlink controls on a multi-mono plug-in:

- Deselect the Master Link button. It is lit when linked, unlit when unlinked.

#### To access controls for a specific channel:

- Select the channel from the Channel Selector.

#### To open a plug-in window for all channels of a multi-mono plug-in:

- Alt-click (Windows) or Option-click (Macintosh) the Channel Selector.

### To link the controls of specific channels:

- 1 Deselect the Master Link button if it is not already deselected.
- 2 Click the Link Enable buttons for the channels whose controls you want to link.

 For information on the Trim plug-in, see the *DigiRack Plug-Ins Guide*.

---

## Paths in Surround Mixes

Because Pro Tools provides a flexible routing and submixing environment, you can maximize your system's available resources by first identifying the elements that you want to pan dynamically and those that can be placed in certain channels only. (See "Mixing with Paths and Sub-Paths" on page 519 for an explanation of this concept.)

Once you have identified these elements in your session, you can use a combination of main and sub-path assignments, and multichannel panning.

### Mixing with Paths and Sub-Paths

It is rare that every track needs to be "flown" (actively panned in between more than a pair of speakers). In most situations, certain elements are placed in certain speakers and remain there, providing the foundation for a mix.

Figure 37 on page 520 illustrates an example of how panning and signal routing can be combined in a multichannel mix. The following sections show you how to organize your session and signal routing to maximize the available resources.

 See "Extending Stereo Mixing Conventions to Surround Mixing" on page 520 for related information.

### When to Assign Multichannel Outputs

- Assign 5.1 paths only to those tracks that need to be panned to all six channels.

For example, a sound effects track with a jet fly-over should be assigned a 5.1 path to be able to fly the sound from front-to-back. In a music mix, fly a solo instrument or make a synth pad swirl around the room as a special effect.

Elements that need to be heard in all speakers simultaneously can also be assigned to the multichannel output, whether or not they need active panning in the sound field.

### When to Use Sub-Paths

- To help simplify large sessions, use sub-paths to route *static* (or, stationary) elements directly to the output channel or channels.

For example, film dialog is often mixed to the center channel to anchor this essential sound element to the picture. Instead of assigning a six-channel panner to dialog tracks and panning the tracks to the center speaker only, you can route the dialog track's main output to a mono (Center) sub-path.

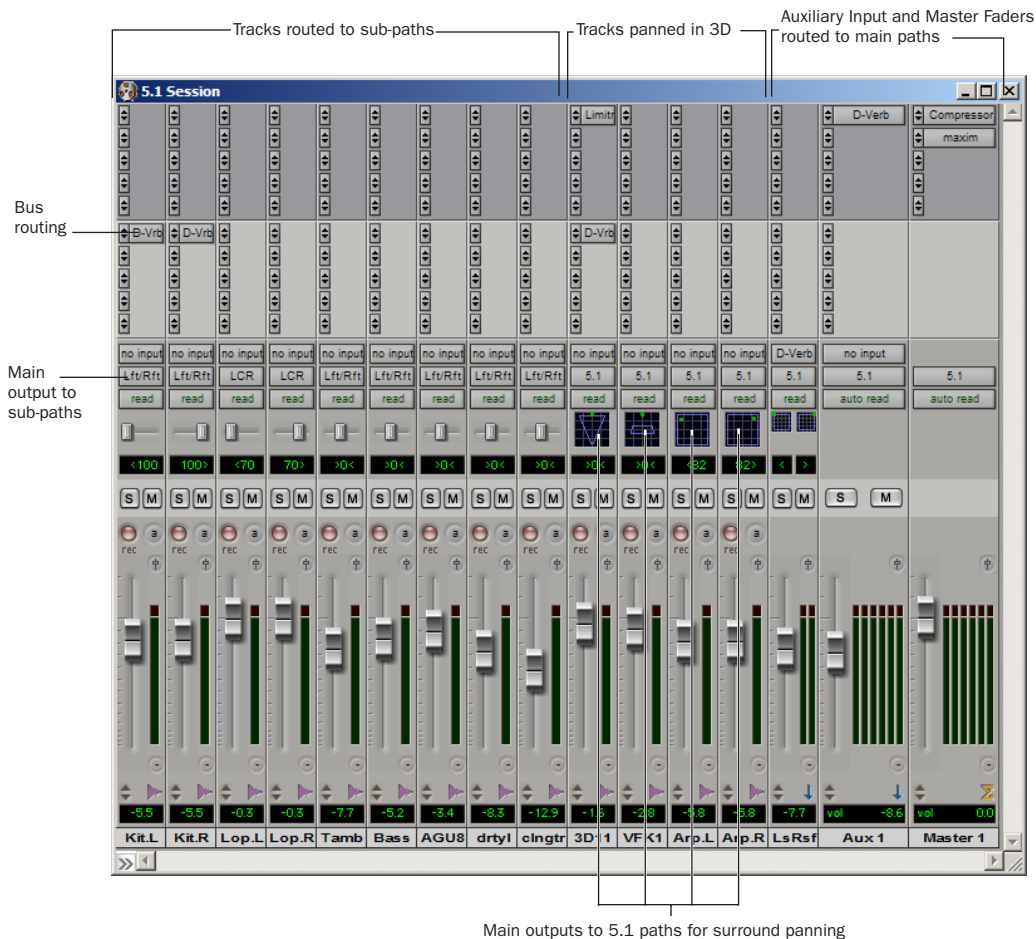

Main outputs to 5.1 paths for surround panning

Figure 37. Using signal routing and sub-paths to mix in surround

## Extending Stereo Mixing Conventions to Surround Mixing

Stereo mixing sets the precedent for active and static panning, and surround mixing can benefit from the same basic principles.

Panning a sound back-and-forth between the left and right speakers is best used as a special effect. In a typical music mix, the basic tracks are placed in the stereo sound field and remain there.

Surround mixes can become incoherent if too many elements are continuously moving. For special effects, some tracks can be panned *dynamically*, bouncing between speakers or sweeping from one side to the other.



## Example Paths and Signal Routing for a Surround Mix

The examples that follow show how Auxiliary Inputs, Master Faders, and other Pro Tools signal routing features can be used for stem mixes, submixes, and similar project needs.

In these examples, music and effects are being mixed for a trailer, in 5.1 surround. Separate stem mixes (for music and for effects) are to be mastered to 8-track MDM.

## Example Multichannel Paths

Signal routing is the key element in any Pro Tools surround session. Signal routing is configured and defined in the I/O Setup dialog.

## Example Output Paths

Figure 38 shows output paths defined in the I/O Setup dialog of an example session that was created on a Pro Tools|HD system with one 192 I/O audio interface.

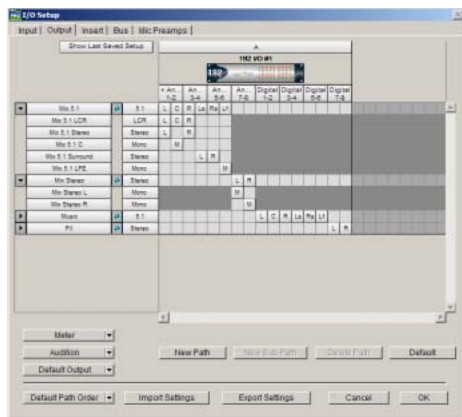

Figure 38. I/O Setup, example output paths

Sub-paths have been defined for Mix, Music, and FX main output paths.

Additional stereo output paths, with mono sub-paths, have also been defined for the remaining channels.

## Example Bus Paths

Figure 39 shows example bus paths.

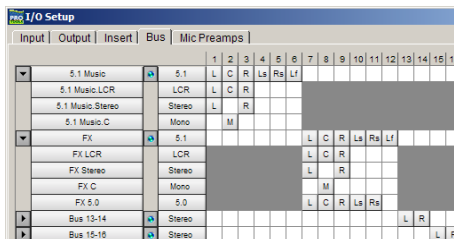

Figure 39. I/O Setup, example bus paths

Two 5.1 format main paths have been defined (“Music” and “FX”), each with several sub-paths.

## Example Sub-Paths

Sub-paths let you route to selective channels within the multichannel surround output. In Figure 40, the FX bus has several sub-paths that show this.



Figure 40. I/O Setup, example sub-paths

**5.0 Sub-Path** The 5.0 FX bus is a 5-channel sub-path. Use this type of sub-path routing to conserve mixing resources with tracks you want to keep out of the LFE channel.

**LFE Path** A custom LFE sub-path has been added to provide a discrete mono path to the LFE channel.

## Signal Routing Examples

The following examples show how main and sub-paths can be used, using an example session consisting of a 5.1 main mix, with music and effects stems (or submixes).

### Submix Stem Examples

Figure 41 shows a routing configuration for an effects submix.



Figure 41. FX stem

Some tracks are routed to stereo sub-paths, while others are assigned to mono, LCR, or other sub-paths. Two tracks (one stereo, one mono) are assigned to multichannel busses for surround panning. A 5.1 Auxiliary Input assigned to the FX main bus path serves as a submixer.

Figure 42 shows a routing configuration for music tracks.



Figure 42. Music stem

Most of the music tracks in this example are routed to the front left/right channels, using a stereo subpath. A 5.1 Auxiliary Input controls the bus and stem output.

### Main Stems Example

Figure 43 shows two Auxiliary Input channels assigned to additional 5.1 format paths for a main mix.

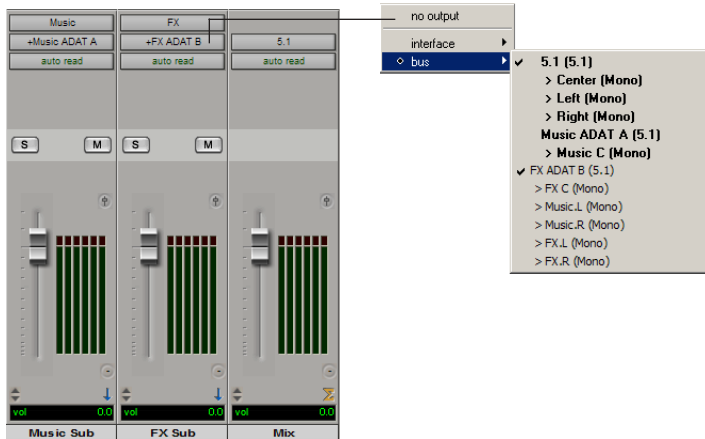

Figure 43. Main stems

Multiple output assignments make it possible to configure a number of multi-format mixes. For example, you can assign an additional stereo output to tracks and create a stereo mix at the same time as a 5.1 mix. For more information, see “Multiple Output Assignments” on page 412.

## LFE Examples

LFE tracks and other audio can contribute to the LFE output in two ways:

- Using the LFE slider in Output windows. This LFE signal is post-fader.
  - OR –
- Using a custom sub-path to route channels discretely.

Figure 44 shows a channel Output window, sending and metering to the LFE channel.

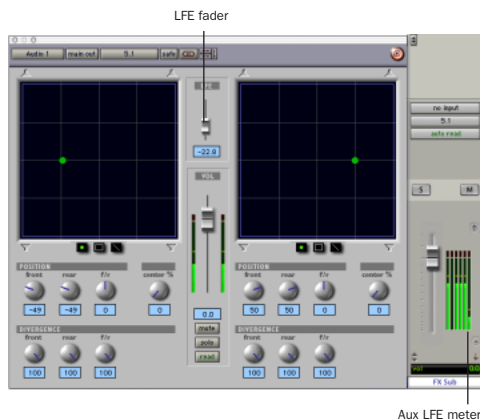

Figure 44. LFE contribution from a stereo output

Using the LFE fader, you can add any amount of any multichannel path to the overall LFE output. In the above example, the track’s Center percentage has been turned off, and the LFE fader has been raised to route it to the LFE channel.

Figure 45 shows how a “traditional” LFE track can be routed to only the LFE channel. This example uses a custom-defined LFE sub-path to the FX main bus path.



Figure 45. Discrete LFE routing

For instructions on how to create a sub-path, see “Custom Multichannel Paths” on page 510.

## LFE and Filtering

Pro Tools applies no filtering to LFE signals. Some delivery requirements may require filtering for the LFE track. See “Mixing Formats and Surround Formats” on page 497 for more information.

 LFE faders can follow Mix and Edit Groups. See “Automation Preferences” on page 456 for more information.

# Chapter 33: Surround Panning and Mixing

This chapter explains how to pan and mix in surround with Pro Tools.

Before you can pan a track in surround, it must be assigned to an appropriate multichannel output or bus path.

The I/O Setup dialog defines the bussing and output architecture of the Pro Tools multichannel surround mixer. If you have not already done so, it is recommended that you become familiar with main and sub-paths and the I/O Setup dialog before starting multichannel Pro Tools projects.

 See Chapter 31, “Pro Tools Setup for Surround” for more information on multichannel configurations and I/O Setup options. For multichannel signal routing, see Chapter 32, “Multichannel Tracks and Signal Routing.”

---

## Introduction to Pro Tools Surround Panning

There are four different track panning methods available:

- In the Edit window, using the reduced-height Panner Grid in the I/O View
- In the Mix window, using the reduced-height Panner Grid
- In the Output window, using the full-size Panner Grid
- Through pan automation editing

Control surfaces provide additional panning options. Refer to the documentation for your control surface for more information.

## Mix and Edit Window Panner Grids

In the Mix and Edit window, multichannel Panner Grids are displayed on tracks that have multichannel track or send output assignments.

### To pan from the Mix or Edit window:

- 1 For Pro Tools 5.x, make sure I/O View is being shown for the Mix or Edit windows (Display > Mix/Edit Window Shows > I/O View).
- 2 Begin playback.
- 3 Click and drag on the appropriate multichannel track's Panner Grid in the Mix or Edit windows.

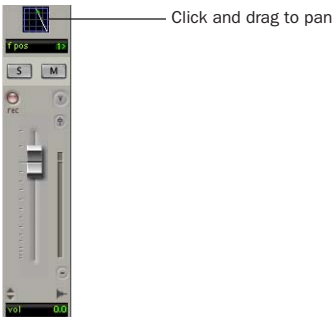

#### *Panning in the Track Grid*

The pan cursor follows your movements as long as you hold down the mouse button. Movements are scaled so that, once you click to “grab” the pan cursor, you do not need to limit your movements to the small Track Grid area.

#### **Pan Cursor Color while Automating**

The pan cursor is green when the track is in Automation Read mode, red in an Automation Write mode, and yellow in Trim mode.

Output windows provide additional features and controls (and a much larger Grid). For details, see “Output Window” on page 526.

---

## Output Window

Output windows provide panning controls (called panners), as well as standard Pro Tools controls, for tracks of all mix formats (from 3-channel LCR through 8-channel 7.1).

For information on Output window standard controls, see “Standard Controls” on page 527. For information on Output window panning controls, see “Surround Panner Controls” on page 528.

Some of the features of Output windows include:

- X/Y (joystick-style) panning
- 3-Knob panning
- Full Divergence and Center Percentage control
- LFE feed
- Multichannel meters
- Pro Tools Target window support

Multiple panners can be opened simultaneously, or a single window can display the current panner.

## To open an Output window:

- Click the Output icon in the track in the Mix or Edit window (I/O View).

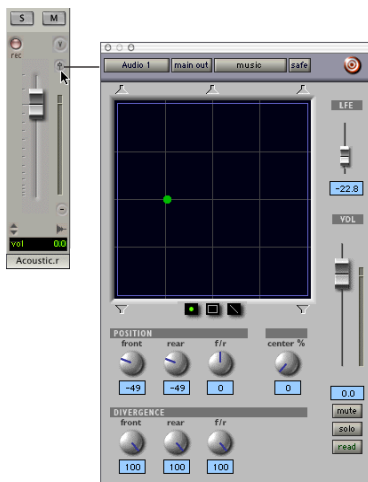

Opening a multichannel Output window

- For instructions on managing multiple Output windows, see “Output Windows for Tracks and Sends” on page 418.

## Standard Controls

All Output windows provide standard Pro Tools controls for routing, path assignment and other track features. These controls are located at the top of all Output, Send, Insert, and Plug-In windows. Some controls are specific to the type of window.

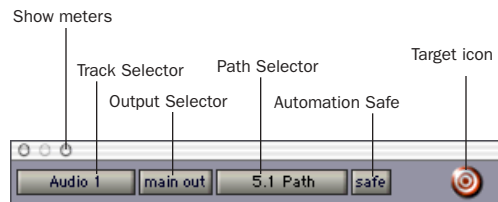

Panner Control Section

- For details on these standard features, see “Standard Selector Controls in Output Windows” on page 421.

## Track Fader, Solo, Mute, and Auto

All Output windows provide track volume and mute controls. You can adjust and automate track volume, or mute, directly using these controls. The larger fader and mute button are equivalent to those in the Pro Tools Mix window.

## Surround Panner Controls

When assigned to tracks or paths with four or more channels, the Output window provides an X/Y Grid for surround panning. The speakers associated with the panner's multichannel format are displayed in their relative positions outside the Panner Grid.

This section identifies all the controls and features found in Pro Tools multichannel panners.

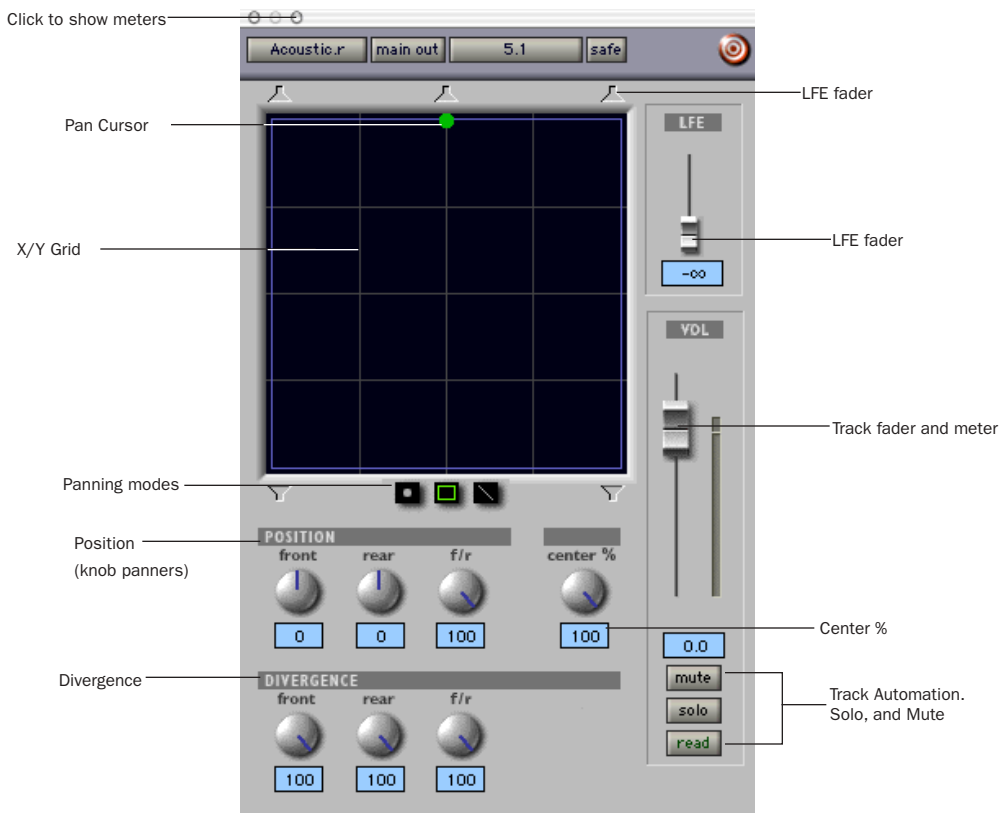
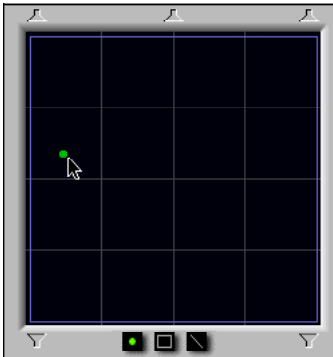

Figure 46. Output window with a 5.1-format multichannel panner



## The X/Y Grid and Pan Cursor

The X/Y Grid is where multichannel panning information is input and displayed. You can input pan information using X/Y mode, 3-Knob mode, or by entering numeric values in the Position data fields. You can also edit pan automation graphically in the Edit window.



*Panning Grid and pan cursor*

Multichannel panners default to X/Y mode. In X/Y mode, the track's current pan position is represented by a green dot. This dot is the pan cursor, and its color indicates track automation status using standard Pro Tools colors:

**Green** The track is in Auto Read mode.

**Red** The track is in Automation Write, Touch or Latch mode.

**Yellow** The track is in Automation Trim or Auto Off mode.

## Panning Mode Buttons

The Panning Mode buttons, located below the X/Y Grid, provide access to panning modes and Divergence editing. See “Panning Modes” on page 530.

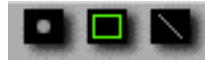

*X/Y Mode, Divergence Editing, and 3-Knob Mode buttons*

## Position Controls

The Position controls let you set the positions of the panner.



*Position and Center % controls*

**Front** Displays and controls the current front X-axis (left/right) position of the panner.

**Rear** Displays and controls the current rear X-axis (left/right) position of the panner. In default X/Y Panning mode, Rear is linked to Front position and cannot be controlled independently.

**F/R (Front/Rear)** Displays and controls the current Y-axis position of the panner.

## Center % Control

Center % controls how much of the signal is routed to the center speaker. This lets you mix a track to the front with a phantom center (0% Center value) or to three-channel (LCR) when panning front.

## Divergence Controls

Divergence determines the width of the panned signal with respect to neighboring speakers. (For more information, see “Divergence” on page 503.) There are three Divergence controls



*Divergence controls*

**Front, Rear, and F/R Divergence** Provide separate, automatable divergence control over front speakers, rear speakers, and between front/rear, respectively.

 For examples of how divergence settings affect output panning, see “Divergence and Center Percentage” on page 533.

## LFE Fader

The LFE fader is only available in “.1” surround formats (5.1, 6.1, and 7.1).



*LFE fader*

The LFE fader determines how much of the current track’s signal will be routed to the LFE channel. LFE faders in Track and Send windows can follow groups. The Pro Tools LFE channel is always full-bandwidth. For more information on how to use the LFE fader, see “LFE Faders in Multichannel Panners” on page 533.

---

## Panning Modes

Pro Tools supports X/Y and 3-Knob Panning modes. Both can be automated.

**X/Y Mode** Joystick-style panning by dragging the pan cursor within the X/Y Speaker Grid.

**3-Knob Mode** Point-to-point panning, between pairs of speakers. See “3-Knob Panning” on page 532 for more information.

## X/Y Panning

**To pan in X/Y mode:**

- 1 Click the X/Y Mode button.

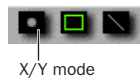

2 Drag the pan cursor, or click anywhere in the Grid and drag to pan the track. The location of the pan cursor determines the pan position of the signal. For example, to pan something to the left rear speaker, move the pan cursor to the lower-left corner of the Grid.

 *It is not necessary to click exactly on the pan cursor. Clicking anywhere in the Grid will move the pan cursor relative to where you click or take over with a hardware panner. Panning does not jump to the click position.*

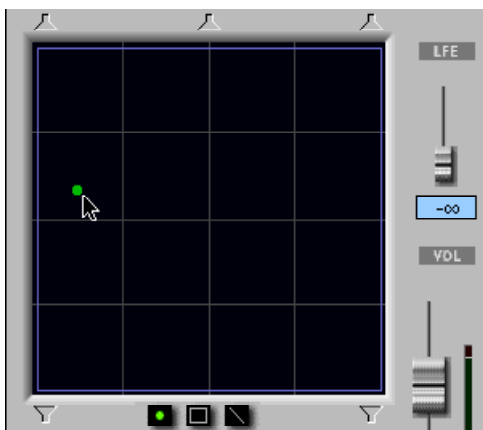

X/Y Panning

**To snap the pan cursor to a location in the Grid:**

- Hold down the Control key and click anywhere in the X/Y Grid.

## Grid Options and Shortcuts

**Fine-Adjust Mode** Hold down the Control key (Windows) or Command key (Macintosh) for fine adjustment of all Panner controls.

**Constraining to X or Y Movement** Shift-drag the pan cursor dot to constrain its movement to the X or Y direction.

**Reset to Default** Alt-click (Windows) or Option-click (Macintosh) in the Panner Grid to reset all controls to their default position.

**Snap To a Speaker in the Grid** Click a speaker icon to force the panner to that speaker location.

**Display Automation in Edit Window** Control-Start-click (Windows) or Command-Control-click (Macintosh) a control to display that control's playlist in the Edit window.

 *All pan controls can be automated, including pan position and divergence. See Chapter 28, "Automation" for details.*

## 3-Knob Panning

Pro Tools provides 3-Knob mode as an additional way to input pan moves.

3-Knob mode lets you:

- Pan in straight lines, moving the pan cursor using the Position rotary knobs with full movement of front, rear, and front-rear position.  
– and –
- Pan discretely between pairs of speakers.

3-Knob mode lets you pan discretely between speakers. For example, when panning front-left to rear-right in 3-Knob mode, audio will be heard from just those two speakers (assuming full divergence is in effect).

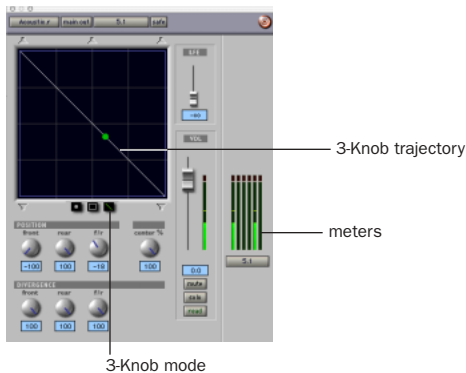

*Panning and metering in 3-Knob mode*

By comparison, in X/Y mode a diagonal pan may result in audio being heard in some or all channels.

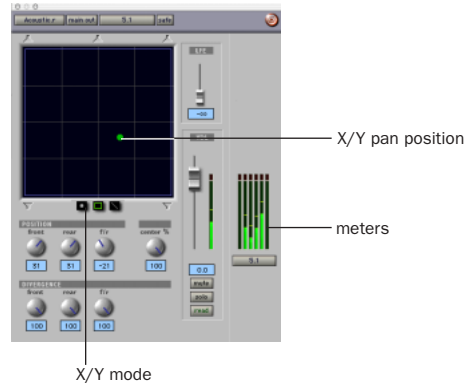

*Panning and metering in X/Y mode*

The difference is that 3-Knob mode pans discretely between the front and rear position of the panning *trajectory*, while X/Y mode panning takes place in the full 360° Panning Grid. Divergence and Center Percentage are variable in both Panning modes.

### To enable 3-Knob Panning mode:

- Click the 3-Knob mode icon.

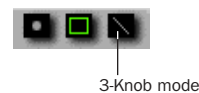

The panner trajectory line appears across the Grid, extending from the front (X-axis) to the rear (Y-axis).

### To pan in 3-Knob mode:

- 1 Adjust the Front and Rear Position knobs to set the trajectory line.
- 2 Rotate the Front/Rear Position knob to pan along the trajectory. The Pan Cursor is constrained to the white trajectory line.

### To change the 3-Knob trajectory angles:

- Drag either endpoint (Front or Rear) of the trajectory line.
  - or –
- Adjust the Front or Rear Position controls.

### To change the current trajectory position (left-to-right) and retain its current angles:

- Drag the trajectory line (not its endpoints) to a new position.

---

## LFE Faders in Multichannel Panners

The LFE fader controls how much of the track is sent to LFE. LFE faders are only available when a track is assigned to a path whose format supports LFE (5.1, 6.1, or 7.1).

### To mix to the LFE channel:

- Adjust the LFE fader in any “.1” surround format Output window.

 For general information about LFE, sub channels, and related topics, see Chapter 30, “Surround Concepts.”

## LFE and Groups

Track and send LFE faders can follow Mix and Edit Groups by enabling this feature in the Automation window of the Preferences dialog. See “Automation Preferences” on page 456 for more information.

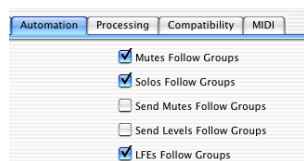

*LFEs Follow Groups preference*

## LFE Enable

Some multichannel plug-ins, including the DigiRack multichannel Compressor, provide LFE Enable. This lets you enable or bypass processing of the LFE channel if present.

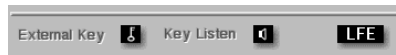

*LFE Enable in multichannel compressor*

### To process the LFE channel in a multichannel plug-in:

- Click to enable LFE Enable in supporting multichannel plug-ins. LFE Enable is highlighted when LFE processing is enabled, and unhighlighted when LFE processing is bypassed.

---

## Divergence and Center Percentage

The Divergence and Center Percentage controls range from 0 to 100, and can be automated. They are especially useful for ensuring audibility and coverage in large venues, and to increase clarity of voices.

**Front Divergence** Controls divergence between front speakers (X-axis only).

**Rear Divergence** Controls divergence between the rear speakers (X-axis only).

**Front/Rear Divergence** Controls divergence between front and rear (the Y-axis).

**Center % (Percentage)** Determines whether there is a *discrete* center image, a completely *phantom* center image, or a variable amount in between.

## Divergence

In the Panner Grid, the current divergence values are displayed using a purple outline.

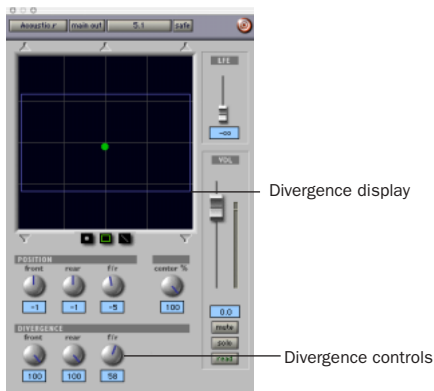

### Divergence display and controls

By default, Pro Tools surround panners are 100% or fully divergent, meaning that a signal that is panned completely to one speaker will only be audible in that speaker.



*Full divergence for discrete panning to front, left (meters show signal only in front, left)*

Lower divergence settings result in a progressively wider source signal. When Divergence is less than 100%, tracks will be routed to neighboring speakers to some degree, even when the pan cursor is positioned next to a single speaker.

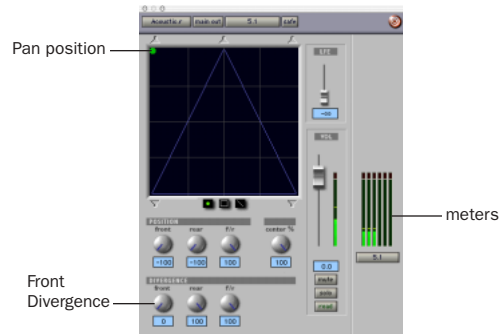

*Front Divergence at 0% for widest panning (note meters showing signal in all three front speakers)*

### To adjust divergence:

- Adjust the Front, Rear, and Front/Rear Divergence controls as necessary.

### To adjust divergence graphically:

- 1 Click the Divergence icon.
- 2 Drag in the Grid to resize the divergence boundaries.

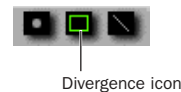

## Center % (Percentage)

Center Percentage controls whether there is a discrete center channel for the track or a phantom center channel.

### Center Percentage Example

In film and video production, the center channel often contains dialog. To enhance the clarity of dialog, it is often beneficial to keep elements such as music out of the center speaker. By reducing the Center Percentage on music tracks, music panned to the front of the soundfield can be panned to only the left and right speakers, forcing them to have a variable phantom center image.

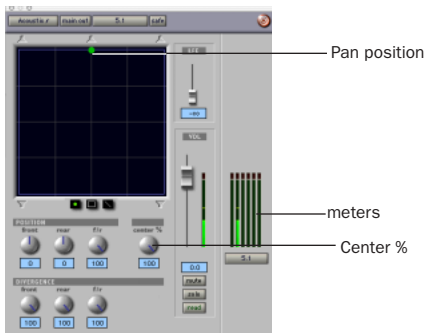

*Discrete center (Center Percentage at 100)*

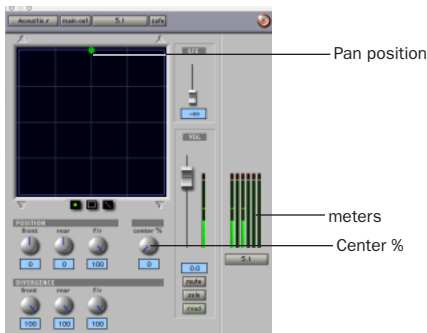

*Phantom center (Center Percentage at 0)*

### To adjust Center Percentage:

- Adjust the Center Percentage knob as appropriate.

As you reduce the Center Percentage value, the center speaker icon at the top of the Grid becomes less visible. At 0, the center speaker icon is completely invisible, reflecting the setting for fully phantom center.

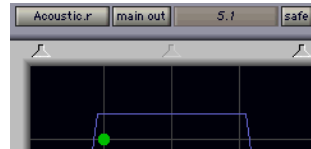

*Center speaker less visible*

## Pan Playlists and Automation

Multichannel panners have an automation playlist for each position and divergence control.

### Panning Does Not Follow Groups

Unlike mute and volume breakpoint editing, pan automation does not follow Edit Groups by default. To force pan automation editing to follow groups, you can hold down the Start key (Windows) or Control (Macintosh) while editing automation breakpoints on a member track. This feature applies to all seven types of pan controls (front, rear, and front/rear pan position, front divergence, rear divergence, front/rear divergence, and center percentage).

---

## SurroundScope Metering Plug-In

The SurroundScope Metering plug-in provides a 360° meter for metering multichannel paths during mixing.

### 5.1 Format Track Layouts

All 5.1-format meters (including those displayed in the SurroundScope meter, on tracks, and in Output windows and their Meter Views) are always arranged in the following order:

L C R Ls Rs LFE

 For more information on Pro Tools metering, see “5.1 Tracks, Formats, Mapping, and Metering” on page 511.

#### To use the SurroundScope Metering Plug-In:

- On a multichannel Master Fader, click an Insert button and select the SurroundScope multichannel Meter plug-in.

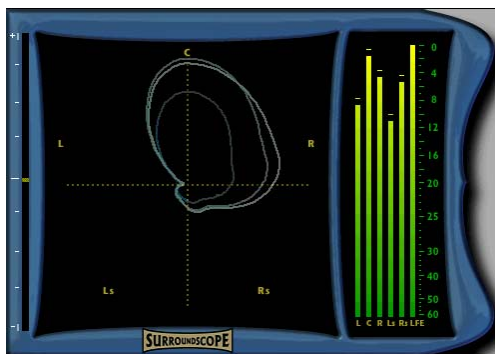

SurroundScope metering plug-in

SurroundScope has no adjustable controls, but displays output levels in both a 360° Grid, and in traditional LED meters.

 Refer to the *Digidesign Plug-Ins Guide*, for details on SurroundScope.



# **Part VIII: Synchronization**



# Chapter 34: Synchronization Concepts

This section is designed to give you a basic understanding of synchronization as it relates to Pro Tools.

If you are using a device that sends or receives time code (such as a video tape recorder or MIDI interface), refer that device's documentation for information on how it generates or receives time code and how to configure its options.

---

## Synchronization Requirements

Synchronization requirements and support vary among different Pro Tools hardware systems. This guide notes whenever a feature requires a synchronization peripheral (such as a Digidesign SYNC I/O, or equivalent). See the guides for these peripherals for details on their installation and configuration.

We strongly recommend that you research your synchronization requirements thoroughly. For example, if you are using Pro Tools for audio post production work for video, consult your video engineer or editor to determine what time code format will be used. Also, there may be additional time code issues that affect how you use synchronization (such as pull-down). Your Digidesign dealer may be able to offer suggestions about working with synchronization in your studio.

## Synchronization Peripherals

Synchronization peripherals include a wide variety of devices, ranging from simple MTC-capable MIDI interfaces, to high precision time code synchronizers capable of handling many professional time code and clock standards used in the music, television, and film industries.

Though many devices are capable of providing synchronization, only the Digidesign SYNC I/O and USD peripherals deliver frame-edge accuracy when synchronizing Pro Tools TDM systems to external time code sources.

---

## Aspects of Synchronization

Synchronization in a digital audio workstation has two concepts that need to be independently considered:

- ◆ “Where are we?” This is called the Positional Reference.
- ◆ “How fast are we going?” This is called the Clock Reference.

To synchronize Pro Tools to another device (such as a tape machine or VTR) accurately over an extended period of time, Pro Tools needs to know where the device is and at what speed it is running. Some peripherals can provide only one

of these references; for example, a black burst generator provides only a clock reference. Some peripherals, such as the Digidesign SYNC I/O, can provide both.

---

## Synchronizing Pro Tools

Pro Tools TDM systems require a clock reference, in addition to time code, to *maintain* correct synchronization once it has been achieved. In addition, transfers (recording) between digital devices *must* be performed to a resolved clock source.

You can resolve Pro Tools to an external clock reference without locking it to a positional reference. For example, you can use any HD-series audio interface to resolve the Pro Tools sample clock to an incoming digital signal (S/PDIF, or Word Clock, for example) without synchronizing Pro Tools to external time code.

In the following example, Pro Tools uses time code for positional information, and a clock reference to maintain synchronization. Pro Tools is slaved, using the SYNC I/O or USD, to a video tape recorder, with Pro Tools and the VTR referenced to the same house video reference source (house sync).

### **Example: Pro Tools slaved, through a SYNC I/O or USD, to a video tape recorder**

In this example, house sync is provided to the SYNC I/O, which provides the master Loop Sync signal to the Pro Tools|HD system through an HD-series audio interface. The SYNC I/O (or USD) can also output 256x Slave Clock as required on Pro Tools|24 MIX and Pro Tools|24 systems. House sync is also provided to the VTR.

**1** When you start the video tape, time code (LTC or VITC) is read from the tape and routed to the SYNC I/O or USD. The SYNC I/O (or USD) reads the time code position and continuously forwards the *positional reference* information down the SYNC I/O serial connection to the Pro Tools card.

**2** Pro Tools takes the first time code address it receives, and calculates the sample location in the session that corresponds to the address. Though you can work with Pro Tools using any standard time code format, it calculates internally in sample numbers.

**3** Assuming that the time code address corresponds to a sample number that is within the Pro Tools session, Pro Tools converts the time code address to a sample number within the session, and begins playing from that point. The point from which playback starts is the *trigger point*. The clock reference is used by Pro Tools and the VTR to keep them running at the same speed.

**4** At this point, if the video tape is stopped, rewound, and started again, the process repeats, based upon a newly calculated trigger point.

## About Positional References

Time code is positional information in an analog signal or a digital streaming signal that can be recorded on magnetic video or audio tape. Time code can be used as a positional reference, to synchronize the playback and recording of your Pro Tools system with another machine's time code signal, such as an analog multitrack tape machine or a video tape recorder (VTR).

## SMPTE and ISO/EBU Time Code

The “Where are we?” question refers to relative position. To describe position, many professional audio, video, and multimedia devices and programs use SMPTE (Society of Motion Picture & Television Engineers) time code. In Europe, a standard called ISO (International Standards Organization) time code, formerly called EBU (European Broadcasters Union) time code, is generally used. These time code types are almost exactly the same in terms of how they are represented electronically. However, ISO/EBU time code works at a fixed rate of 25 fps (frames per second) and SMPTE includes provisions for several different frame rates. For the purposes of explanation, this chapter will generally refer to frame-measured timing information as “SMPTE time code.” This description should be understood to include SMPTE and ISO/EBU time code.

## SMPTE Time Code Methods

There are two basic techniques used to record SMPTE time code onto magnetic tape: LTC (Linear Time Code) and VITC (Vertical Interval Time Code). LTC is recorded or generated on an audio channel or a dedicated time code track of the audio or video device. VITC is recorded within the video signal in the video “blanking area” of each video frame. VITC cannot be recorded on audio tracks, so it has no application when working with audio tape recorders, but it does offer features for post production (such as still frame and slow speed time code address reading).

There is also a non-SMPTE form of time code called MIDI Time Code (MTC) that some devices use to send timing information.

## SMPTE Time Code Units

Time code describes locations in terms of hours, minutes, seconds, frames, and subframes (1/100th of a frame). The frame is used as a unit of time measurement due to SMPTE time code’s origin in film and video applications (see also “Frame Count and Frame Rate” on page 541.) Depending on the SMPTE frame rate, one frame is equal to 1/24th, 1/25th, 1/29.97th, or 1/30th of a second. For example, a video tape time code reading of “01:12:27:15” would tell us that we were at a position of one hour, twelve minutes, twenty-seven seconds, and fifteen frames. However, this time address alone does not tell us frame rate information.

Because SMPTE stores an absolute time reference on the tape in the form of time code, any location on that tape can be precisely located by devices that read time code. Once the time code has been recorded or *striped* on a tape, it provides a permanent positional reference that allows Pro Tools to link the playback of an event to an exact tape location. For example, with time code synchronization, a gun shot sound effect can be played at the precise instant that the gun’s flash appears on-screen.

## Frame Count and Frame Rate

It is important to remember the difference between frame count and frame rate.

*Frame count* is the amount of frames that the time code counts before ascending to the next second count. Standard frame counts are:

*Frame counts per frame rate*

Frame Count	fps
frames 0–23	24
frames 0–24	25
frames 0–29	30

“Frame rate” is the rate of speed that the time code is ascending through the frames. For example, when someone refers to a time code of 29.97, they usually are referring to “using a frame count of 30 frames, but counting each frame at the speed of 29.97 frames per second.”

## **LTC (Longitudinal or Linear Time Code)**

LTC is time code that is recorded and played back, or generated, in the form of an analog audio signal. LTC is supported by many audio and video tape recorders.

### **LTC Speed Usage**

LTC can be read at high tape shuttle speeds, allowing a machine’s time code reader to communicate with synchronizers at rewind or fast forward speeds exceeding 50 times playback speed (provided the tape recorder is able to reproduce the time code at this speed). However, LTC cannot be read at very slow shuttle speeds (such as when you are “crawling” the tape frame by frame) or when the machine is paused. With LTC, the VTR must be running (usually at a minimum speed of about 1/10th normal playback speed) in order to capture a SMPTE time address.

## **VITC (Vertical Interval Time Code)**

VITC is a type of time code that is recorded and played as an invisible part of a video signal. VITC is commonly used in professional video editing and audio-for-picture applications. Because VITC is recorded as part of each video frame, it must be recorded at the same time as the video signal—it cannot be added later as LTC can. Since VITC cannot be recorded on audio tracks, it is never used to synchronize audio-only recorders. Instead, LTC is most often used in audio-only applications.

## **VITC Speed Usage**

VITC’s ability to be read when moving a VTR transport at slow speeds or when the VTR is paused makes it more useful than LTC in these situations. When VITC is used, Pro Tools can capture the current SMPTE time from the VTR when it is paused or in “crawl” mode. However, if you are using additional external transport synchronizers in your setup, most synchronizers cannot read VITC at speeds exceeding approximately 10 times playback speed, preventing slaved machines from maintaining synchronization during rewind and fast forward.

### **LTC/VITC Auto-Switching**

Many synchronizers and devices support automatic switching between LTC and VITC, depending on the speed, to get the best of both worlds (both the SYNC I/O and USD support auto-switching). For example, VITC might be used when a VTR is paused, or crawling frame-by-frame, while the synchronizer might automatically switch to LTC when fast-forwarding.

## **Bi-Phase/Tach**

This electronic pulse stream is used by film mag recorders, film editing stations, and film projectors. You can use this format to synchronize Pro Tools if you have a SYNC I/O (or USD). Unlike time code, Bi-Phase/Tach doesn’t actually contain absolute location information. It simply supplies speed (based upon the frequency of the pulses) and direction, and therefore, relative position. Since the SYNC I/O can “count” both the speed and direction of the stream of pulses, it can use a Bi-Phase/Tach source to deduce positional information from a starting “address point.” The difference between Bi-Phase and Tach formats is that Bi-Phase encodes rate and direction on a pair of signals using a format

called phase-quadrature, while Tach encodes rate on one signal and direction on the other. For more information on Bi-Phase/Tach, see the *SYNC I/O Guide*.

---

## SMPTE Frame Formats

Several different formats of SMPTE time code exist, and Pro Tools can synchronize to all common formats with a compatible synchronization peripheral.

 *When you work with NTSC video (the standard in North America and Japan), you will generally work with the NTSC color video standard: either 29.97 fps Non-Drop or 29.97 fps Drop frame. If you are working with PAL, your frame rate is 25 fps.*

Pro Tools supports the following SMPTE frame rates:

### 30 fps Frame Format

This is the original SMPTE format developed for monochrome (black & white) video, and is commonly used in audio-only applications. This format is often referred to as 30 Non-Drop frame format.

### 30 fps Drop Frame Format

Some field film recordings are done at 30df so when they get pulled down after the telecine transfer, they will end up as 29.97df.

### 29.97 Non-Drop Frame Format

This format is used with NTSC color video. It runs at a rate of 29.97 fps.

### 29.97 Drop Frame Format

NTSC color video has an actual frame rate of 29.97 fps, so an hour's worth of frames (108,000) running at 29.97 fps Non-Drop will take slightly longer than one hour of real time to play. This makes calculating the actual length of a program difficult when using 29.97 Non-Drop time code. A program that spans one hour of 29.97 Non-Drop time code addresses (for example, from 1:00:00:00 to 2:00:00:00) is actually 60 minutes, 3 seconds and 18 frames long.

To make working with 29.97 time code easier for broadcasters, the SMPTE committee created 29.97 Drop Frame time code, which runs at exactly the same speed as 29.97 Non-Drop (non-drop frame) time code, but compensates for the slower speed by “dropping” (omitting) two frames at the top of each minute, with the exception of every 10th minute. For example, the time code address of 1:01:00:00 does not exist in drop frame code because it has been skipped.

 *Note that even though time code addresses are skipped in drop frame format, actual frames of video material are not dropped.*

At the end of a program that spans precisely one hour of drop frame time code (for example, 1:00:00:00 to 2:00:00:00), exactly one hour of real time has elapsed.

Although it sounds complicated, drop frame time code allows broadcasters to rely on time code values when calculating the true length of programs, facilitating accurate program scheduling.

## 25 fps Frame Format

This format is used with the European PAL video standard, which runs at a 25 fps frame rate. This format is also called the EBU (European Broadcast Union) format because it's used by broadcasters throughout most of Europe.

## 24 fps Frame Format

This format is used for high-definition video and film applications. Film is typically photographed and projected at a 24 fps frame rate, so this SMPTE format is useful when one time code frame should equal one film frame

## 23.976 fps Frame Format

This format is used for high-definition digital video production using NTSC video equipment, and film applications.

---

## Working with Film-Originated Material

When you do post production work in Pro Tools, you will usually work with video material. However, it is possible that the video you are working on was shot on film.

Film footage and production sound go through separate conversion processes before they reach video, and the audio post production stage. The film is transferred to video using a process called Telecine, using a method called 3:2 Pulldown. Audio can also be pulled down during the transfer, or you might end up working with audio that has not been adjusted (production sound).

Typically, during the Telecine process, a master digital video tape is created, along with a work copy on Betacam or 3/4-inch analog video tape for the picture editor to use. At the same time, a new audio master may be created by slowing

down, or *pulling down* by 0.1%, the production sound to compensate for the change in speed from film to NTSC video. (See Figure 47 on page 546.)

## Guide Tracks and Conforming

In the Video editing process, the audio track produced by the video editor (the "guide track") is rough and needs to be enhanced and improved by the audio engineer. For this reason, the audio engineer will need to re-assemble the original sound elements in a process known as *conforming*.

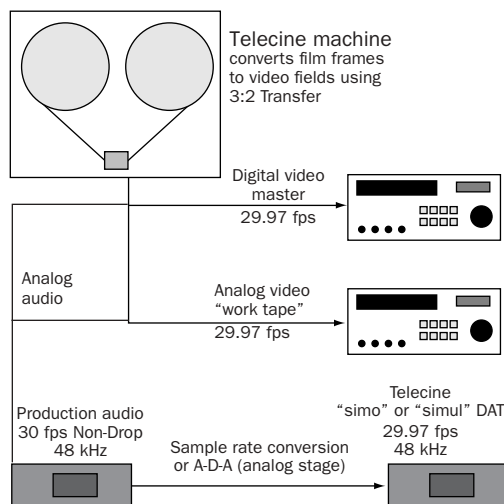

*The Telecine stage of video post production*

## 3:2 Pulldown

A film clip that lasts 1000 seconds consists of 24,000 film frames (pictures). If you want to transfer that film to 1000 seconds worth of NTSC color video, you have to fit 24,000 film frames into 29,970.02997 video frames.



If we use the black and white NTSC video standard (30 fps) instead of 29.97 fps, the process of converting film frames to video frames is greatly simplified. Now instead of any fractional frames, we have 24,000 film frames going into 30,000 video frames (60,000 video fields). In the Telecine process (for NTSC color video), each odd film frame is copied to two video fields, and each even film frame is copied to three video fields, creating what is called a 3:2 Pulldown. The speed of the film is also “pulled down” to 23.976 fps in order to accommodate the slower speed of NTSC color video compared to NTSC black and white video (29.97 fps compared to 30 fps).

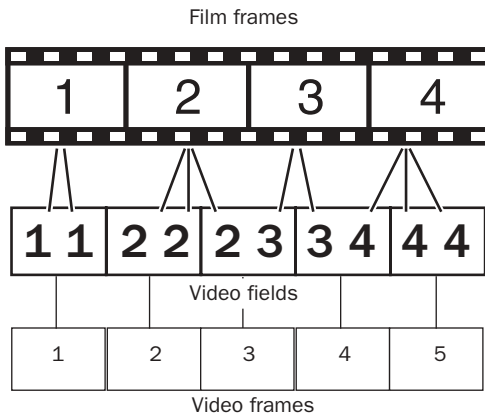

*How film frames translate to video fields and frames in a Telecine transfer*

## Film Speed Differs from NTSC Video Speed

When spotting audio to video that was transferred from film to NTSC video, there are two important terms to keep in mind: film speed and video speed.

**Film Speed** Film speed refers to audio that was recorded and plays back in synchronization with the original film material. This audio often comes from production reels recorded on a Na-

gra® recorder or a field DAT recorder, and is usually striped with 30 Non-Drop time code. Film must be pulled down 0.1% when being transferred to 29.97 NTSC. Film must be pulled up by 4.16667% when film is being transferred to PAL.

**Video Speed** Video speed refers to audio that is running at the NTSC color standard of 29.97 fps. Video speed is 0.1% slower than film speed, so audio that is still at film speed will be out of sync with the video.

In Figure 47, note the following:

- The vertical arrow at the left (“faster” “slower”) represents program speed or rate.
- Telecine is a frame count conversion (for example, 24 to 30).
- The speed you play the result back is a frame rate conversion (for example, 30 to 29.97).

The following table lists the applications for each of the frame rates and counts shown in Figure 47 on page 546.

*Frame Rates and their Applications*

Frame Rate	Applications
25 fps	PAL
24 fps	Film, and 24P HD
23.976 fps	24P pull down, for NTSC broadcast, and HD digital video
30 fps	30 frame music production, and 30 frame recording for film
29.97 fps	Broadcast NTSC video

## Frame Rates and Relative Playback Speeds

The following diagram illustrates the relative playback speeds of SMPTE formats.

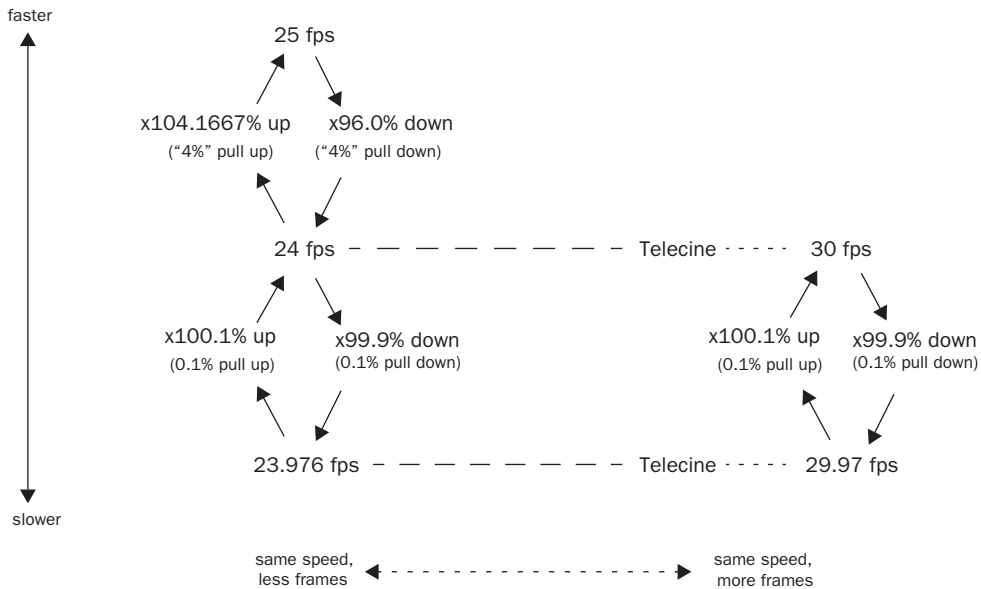

Figure 47. Frame rates, telecine transfers, and relative playback speeds

## Pull Up and Pull Down

*Pull Up* and *Pull Down* are terms used to refer to the deliberate recalibration of the audio sample rate clock (speed, or musical pitch) in order to compensate for a speed change. Pro Tools can be used to pull down or pull up audio or video playback rates. Pro Tools 5.3.1 and higher support pull rates known as "4% factors" (4.0% down, or 4.167% up to be exact), applicable to audio and video playback, to support PAL/film/NTSC conversion requirements.

Pull Down allows you to play back film-originated material at video speed (-0.1%). Pull Up allows you to play back video speed material at film speed (+0.1%).

Using Pro Tools in Pull Up or Pull Down modes requires a SYNC I/O, USD, or third party synchronizer.

## When to Pull Up or Pull Down

There are many ways to get audio into Pro Tools for post production. Consider your source audio and your final destination format carefully. In some cases, audio will already be pulled down for you. In other cases, audio will have to be temporarily pulled down. In still other cases, you may choose to pull down your audio source, like a DAT deck, then use a D-A-D (digital-to-analog-to-digital) process, or the Sample

Rate Conversion option on the 192 I/O, to record the audio into Pro Tools at the proper sample rate. Or you may choose only to pull Pro Tools up or down on delivery of the audio.

Because mistakes in pull factors can be expensive, good communication with other participants in the project is critical. Find out as soon as possible how your task relates to the rest of the project.

### **Final Audio Destination: Film**

If your final destination is film, your source audio is at film speed, and your goal is to edit and mix audio in Pro Tools and then lay back to a device that runs at film speed (such as mag or time code DAT), you can temporarily pull down the audio in Pro Tools for NTSC video work, then return the audio back to film speed when you're finished (by disengaging pull down).

For example, film speed audio from a field audio recorder that is referenced to 30 fps time code is recorded into your Pro Tools system at a sample rate of 44.1 or 48 kHz. Keeping in mind that film speed is faster than video speed, select 30 fps in your Session Setup window in Pro Tools, and record in your audio online and referenced to the time code on the field audio recorder.

 *Most “simul-dats” or “simo-dats” already have their audio pulled down, and should not be pulled down further.*

Once all the audio has been recorded, and you are locked to a video work print (at video speed), enable Pull Down. If you are using a Digidesign SYNC I/O, select Pull Down in the Session Setup window. If your synchronizer is not a Digidesign product, select Pull Down on the front of your synchronizer, then enable Pull Down in the Pro Tools Session Setup window. At this point, it is highly recommended that you verify

whether the video you're working with is striped with 29.97 Drop Frame or Non-Drop Frame time code. While in Pull Down mode, you can work with your reference video and everything will remain synchronized and run at the proper speed (assuming your system is completely resolved).

Once you are ready to lay back your completed project to an audio device running at film speed, deselect Pull Down in the Session Setup window, and from your synchronizer if it is not a SYNC I/O. Then change your time code frame rate in the Pro Tools session back to 30 fps. Once Pull Down has been deselected, the audio played back from Pro Tools will synchronize perfectly with the edited film.

Alternatively, you can pull down the source audio deck while recording audio into Pro Tools, work at 29.97 fps with no Pull-Down selected in Pro Tools, and then switch to 30 Non-Drop frame format, and select Pull Up during the delivery stage. You will have to perform a sample rate conversion on the audio either digitally or by using an analog stage (D-A-D).

Only the inputs on the Digital I/O card (on the 192 I/O) feature real-time sample rate conversion.

 *You will also need to select the Audio Rate Pull Up/Down option in the Session Setup window.*

## Final Audio Destination: Video

If you are working with video that was transferred from film, your audio source is at film speed, and the final layback destination is NTSC video (or television), and you would like to provide a digital transfer to your clients, you will need to alter the above recipe slightly. Keep in mind that when you are working in Pull Down mode, your active sample rate is 44.056 kHz (if the audio was recorded at 44.1 kHz) or 47.952 kHz (if the audio was recorded at 48 kHz).

### Pull Down the Audio Source

Some professional DAT machines will let you pull down the sample rate to 44.056 kHz (and 47.952 kHz). You can record this audio into Pro Tools using a D-A-D (digital-to-analog-to-digital) process, or Digidesign's 192 I/O Sample Rate Conversion option. Then your audio will be at the correct speed for the remainder of the project, since the final destination is video, and no Pull Down or Pull Up is necessary.

### Pull Up Pro Tools While Recording

If you cannot pull down your source, you can accomplish the same thing by Pulling Up Pro Tools, and setting your SMPTE frame format to 30 fps, before recording in the production sound. First select 30 fps as the frame format in the Session Setup window. Then select an Audio Rate Pull Up option in the Session Setup window (and on your synchronizer if it isn't a SYNC I/O) before you record in the production audio. In this case, while the production audio is running at 44.1 or 48 kHz, Pro Tools is running (and recording) at a rate of 44.144 or 48.048 kHz. After all the production audio has been recorded into Pro Tools, reset the Audio Rate Pull to none in the Session Setup window, and on your hardware synchronizer if it is not a SYNC I/O. After you deselect Pull Up, the re-

corded audio will play back 0.1% slower, synchronized with the video, while achieving a true playback sample rate of 44.1 or 48 kHz. Note that this process is designed for a final destination of video; to bring this audio back up to film speed you would have to pull up Pro Tools and record to a destination that is not Pulled Up.

## Note on Sample Rate Conversion

In many cases, you have to perform a sample rate conversion at some point, either digitally, or by recording in audio using an analog stage (D-A-D). The only situation where sample rate conversion never has to be performed is when you are working with film speed audio and your final destination format is film. Then you can simply pull down Pro Tools while you work with the video, then deselect Pull Down to set the audio back to film speed.

On the 192 I/O and 192 Digital I/O, the inputs on the Digital I/O card feature real-time sample rate conversion.

## Using Digital Input

If you are working with Pull Up or Pull Down, do not "resolve" to any digital inputs that are used as audio sources in Pro Tools. This would override the use of the SYNC I/O as the clock reference. Any equipment providing digital audio sources to Pro Tools should be synchronized externally.



*You will also need to select the Audio Rate Pull Up/Down option in the Session Setup window.*

# Chapter 35: Working with Synchronization

Synchronization allows one system to output time code and the other device to follow that time code. Pro Tools is synchronized to other devices using SMPTE/EBU time code or MIDI Time Code. For more information on different SMPTE/EBU formats, and other concepts related to time code, refer to Chapter 34, “Synchronization Concepts.”

---

## Pro Tools Synchronization Options

There are several options for synchronizing Pro Tools to an external source or using Pro Tools as the master device. Not all options are available on all Pro Tools systems, as noted.

### SMPTE Trigger Only

This solution is useful for short projects if both systems are extremely close in speed, but even the best systems will rarely stay perfectly synchronized for longer than a couple of minutes.

## SMPTE Trigger Resolved with SYNC I/O

### (TDM Systems Only)

You can use the optional SYNC I/O, or an equivalent third-party device to resolve Pro Tools recording and playback speed with any of the following clock reference sources while slaving Pro Tools to time code:

- LTC
- Video source
- House video reference
- VITC
- 1x Word Clock
- AES/EBU “null” clock
- Pilot Tone
- Bi-Phase

This enables long-term, high-fidelity synchronization when all transports within the system are resolved to this common synchronization source, or by resolving to any variations in incoming time code while slaving to time code.

## **SMPTE Trigger while Locking to an Unresolved Source**

### **(TDM Systems Only)**

SMPTE Trigger can be used with the optional SYNC I/O or equivalent device to resolve Pro Tools recording and playback speed while slaving to LTC. This enables long-term, accurate synchronization by resolving to any variations in incoming time code. The SYNC I/O also supports VITC and Bi-phase/Tach positional reference.

## **SYNC I/O Synchronization Options**

By adding the SYNC I/O to your Pro Tools TDM system, you can use Pro Tools as the master device in your synchronization setup. All other devices are then slaved to Pro Tools.

You can use Pro Tools in conjunction with SYNC I/O to generate LTC, MIDI Time Code, or MMC commands. When SYNC I/O is reading incoming SMPTE time code, it regenerates the time code through the LTC or MTC output connector. This signal can be passed along to other slave devices.

## **MachineControl™**

The SYNC I/O also supports Digidesign MachineControl software, which provides many specialized features for post-production synchronization tasks including remote track arming, VTR emulation, serial time code, and other capabilities. (See the *MachineControl Guide* for more information, or contact your Digidesign dealer.)

 For instructions on connecting an external synchronization peripheral to your Pro Tools system, refer to the *Getting Started Guide*. If you are using SYNC I/O, refer to your SYNC I/O documentation.

## **Ext. Clock Output**

Pro Tools can be used as the master device in your synchronization setup, where all other devices are then slaved to Pro Tools word clock output.

With Pro Tools|HD systems, clock output can be configured for 1x word clock, or 256x Slave Clock for Digidesign Legacy I/Os (such as 888|24 I/O). See the *Getting Started with HD Guide* for more information on clock output and Legacy I/Os.

### **To set Ext. Clock Output:**

- 1 Choose Setups > Hardware Setup in Pro Tools.
- 2 Click the Ext. Clock Output pop-up menu and select an available signal.
- 3 Click OK to close the Hardware Setup dialog when you have finished.



*If the Legacy Port is enabled (as opposed to the Expansion Port) then the Ext. Clock Output automatically switches to Slave256x. To reset the Ext. Clock Output, the Port Settings button must be set back to Expansion and the Legacy I/O must be set to No Interface. (To set a Legacy I/O to No Interface, select its name in the Peripherals list, then choose No Interface from the Interface pop-up menu.)*

## Session Setup Window

The Session Setup window lets you configure various time code-related settings on your system. The window also includes display-only areas for session sample rate, file format, and bit depth.

 *Pro Tools LE systems with DV Toolkit support various time code-related settings (such as Time Code and Feet+Frame Timebase Rulers). For a complete list, refer to the DV Toolkit for Pro Tools LE Guide.*

## Session Setup Window

The Session Setup window is organized into three view sections. Session displays and settings are displayed at the top of the window. The SYNC Setup & Session Offsets section, and the Time Code Settings section, can be shown or hidden using their dedicated Expand/Collapse icons.

### To expand SYNC Setup & Session Offset section:

- Click the SYNC Setup & Session Offsets Expand/Collapse icon.

The controls in this section configure settings of the Digidesign SYNC I/O. Settings are provided for Clock and Positional Reference, Video Format, and Variable Speed Override.

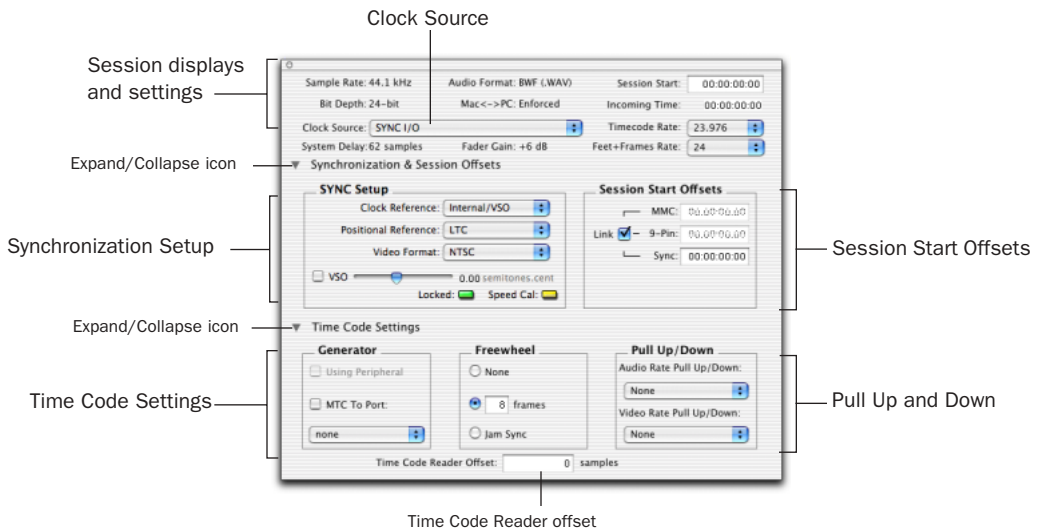

Figure 48. Session Setup window (with SYNC I/O)

### To show Time Code Settings section:

- Click the Time Code Settings Expand/Collapse icon.

The controls in this section provide time code generation and freewheel options, and separate pull up and down selectors for audio and video rates.

## Session Displays and Settings

### Sample Rate

This display indicates the sample rate for the current session.

### Bit Depth

This display indicates the bit depth for the current session.

### Audio Format

This display indicates the file format for files recorded in the session.

### Mac<->PC

This display indicates whether Pro Tools is set to create sessions and audio files that are usable on both Windows and Macintosh.

### Clock Source (Sync Mode)

Use this menu to configure the system Clock Source. You can choose between a SYNC I/O, an internal clock source from a digidesign card or peripheral, or an external clock source connected to an HD-series audio interface.

 *Changes made to Clock Source in the Hardware Setup window will be reflected in the Session Setup window and vice versa.*

### Clock Source Options

**SYNC I/O** When using a Digidesign SYNC I/O, Pro Tools receives its clock source from the SYNC I/O, and the SYNC I/O can in turn reference an external clock source listed in the SYNC setup selector.

**Internal Mode** In Internal mode, your system will reference your Digidesign card or peripheral's quartz crystal oscillator and play back at the session's sample rate.

**External Clock Sources** Depending on your HD-series audio interface, external Clock Source options can include AES/EBU [Encl.], S/PDIF, Optical [Encl.], AES/EBU 1-8, TDIF, ADAT, and Word Clock (optional word clock rates are available at higher frequencies). External sources can be 1x any sample rate or the "base" rate. Base rate equals 44.1 kHz for 88.2 and 176.4 kHz; 48 kHz for 96 and 192 kHz. If an external source is chosen, and no valid sync clock is detected at the External Clock In, the I/O will return to Internal mode.

 *If SYNC I/O is enabled in the Peripherals dialog, and is correctly connected in the Loop Sync chain, SYNC I/O can be the Loop Master, and HD I/Os will clock as Loop Sync slaves.*

For more information on external clock sources, see the *SYNC I/O Guide*.

### System Delay

This display indicates the total amount of system delay (in samples) caused by plug-ins and mixer routing.

### Fader Gain

This display indicates the maximum fader gain level for the session.



## Session Start

Use this field to specify a SMPTE start frame location for your session. See “Setting a SMPTE Session Start Time (Start Frame)” on page 557.

## Incoming Time (Current Time)

This display indicates incoming time code.

## Timecode Rate

This menu lets you set the SMPTE timecode rate for the current session. In Pro Tools 6.4, this menu is labeled Timecode Rate. In Pro Tools 6.2 and below, this menu is labeled Frame Rate.

## Feet+Frames Rate

This menu lets you set a specific feet+frames rate for the current session. This rate can be a different fps rate than the timecode rate.

## SYNC Setup Settings

The controls in the SYNC Setup section let you configure SYNC I/O settings, including clock reference, positional reference, video format, and VSO.

These controls are grouped in the Synchronization Settings section.

## Clock Reference

This menu lets you set the Pro Tools clock reference.

When using a Digidesign SYNC I/O, the Clock Reference selector lists all supported clock types for the Digidesign synchronization interface.

When using Pro Tools|HD without a SYNC I/O, choices include any currently-enabled digital format or source available from your HD-series I/O (such as AES, S/PDIF, or 1x Word arriving at the Pro Tools|HD interface’s Word Clock In port).

When using Pro Tools|24 MIX, the clock reference can be 256x Word Clock, or the references supported by a SYNC I/O.

## Positional Reference

Use this menu to set the time code source for Pro Tools to use for positional reference.

## Video Format

Use this menu to set the session for NTSC or PAL format.

## Variable Speed Override (VSO)

Variable Speed Override (VSO) requires a SYNC I/O.

- ◆ When a SYNC I/O is connected to a Pro Tools|HD system, the VSO controls are located in the SYNC Settings section of the Session Setup window.

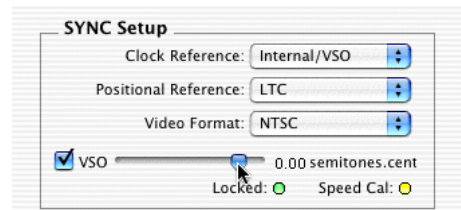

VSO slider (Pro Tools 6.x)

- ◆ When a SYNC I/O is connected to Pro Tools|24 MIX or Pro Tools|24 system, the Session Setup window expands to display additional controls for VSO, clock, and Positional Reference.

Refer to the *SYNC I/O Guide* for instructions on using VSO to varispeed Pro Tools playback.

### **Locked Indicator**

The Locked indicator stays lit when the SYNC I/O is locked to the selected clock reference. The Locked indicator flashes if the selected clock reference source is missing or out of lockable frequency range.

### **Speed Cal Indicator**

Speed Cal is an indicator of the accuracy of the incoming clock reference. The Speed Cal indicator is lit when the output frequency is within 200 ppm (0.02%) of the selected sample rate. The Speed Cal indicator turns off when the output sample rate is not at the expected (or target) rate.

## **Session Start Offsets**

### **(Pro Tools 6.x Only)**

Pro Tools lets you compensate for devices that are consistently offset by a fixed number of frames (such as some color-corrected video masters), or for material that starts at a different time than the session.

Pro Tools provides three different types of Session Start Time Code Offset settings. These offsets include:

- MMC (MIDI Machine Control)
- 9-Pin (Serial machine control)
- Synchronization peripherals (such as the SYNC I/O, or a MIDI interface that provide MIDI Time Code).

Positive and negative offset values can be entered to offset Pro Tools time code display later or earlier, respectively.

Unique values can be defined for each of these three types offsets, or you can link all three to adjust in unison.

If you are using Digidesign's MachineControl option, additional Session Start Offset options are available. See the *MachineControl Guide* for more information.

## Time Code Settings

The Time Code Settings section provides generator, freewheel, and pull up/down options.

These controls are located in the Time Code Settings section of the Session Setup window. Click the Time Code Settings expand/collapse icon to show or hide these controls.

### Generator

The Generator lets you enable Pro Tools generation and output of LTC and MTC using the SYNC I/O. For more information, see “Generating Time Code” on page 563.

**Using Synch** This option outputs time code from the Device type selected in the Synchronization page of the Peripherals dialog.

**MTC to Port** When enabled, outputs MIDI Time Code to the MIDI destination selected in the pop-up menu. In Pro Tools on Windows, choices appear as they are in your windows configuration (for example, Port 1, Port 2, and so on). In Pro Tools 6.x on Macintosh, choices are based on your AMS profile (Audio MIDI Setup).

## Freewheel

The choices in the Freewheel section let you configure how Pro Tools will *freewheel*, or continue playback if time code is interrupted or corrupted. Use these options to protect against errors that can occur if your SMPTE time code source has “drop outs” or temporary lost signals.

**None** No freewheel is applied.

**Frames** Sets a number of frames to freewheel, from 1 to 120 frames. This value defaults to 8 frames, which is the recommended setting for most applications.

**Jam Sync** Lets Pro Tools trigger synchronization to incoming time code, and continue to play back even if time code input is completely interrupted. It can be useful if time code is damaged, or has been accidentally erased from your source tape.

### Pull Up/Down

When Pro Tools is used in conjunction with a SYNC I/O, or a third party peripheral or synchronizer that supports pulled sample rates, this option allows you to “pull up” or “pull down” the current sample rate.

For general information, see “Working with Film-Originated Material” on page 544. For more information on applying pull factors in Pro Tools, see “Pull Up and Pull Down” on page 558.

**A** *Remember, pull up and pull down are applied differently in different workflows. Make sure you check each project’s specific workflow before you begin your work.*

## Time Code Reader Offset (Sync Offset)

This field lets you set a *trigger offset* for incoming MIDI Time Code (anywhere from -100000 to +100000 samples). This allows you to create a permanent offset to fine-tune the point at which Pro Tools synchronizes relative to incoming time code. For example, a value of -50 makes an event in Pro Tools occur 50 samples before the same event in the incoming MIDI Time Code. Use this to compensate for timing differences between various SMPTE-to-MIDI Time Code converters or analog-to-digital/digital-to-analog converters.

---

## Preparing to Work with SMPTE

The first step when preparing to work with SMPTE is to choose an appropriate SMPTE frame rate. Pro Tools supports all standard SMPTE frame rates. For a full explanation of these SMPTE frame rates, see “SMPTE Frame Formats” on page 543.

### Determining SMPTE Frame Rate

It’s always best to determine the SMPTE frame rate through labeling procedures or communication, but this is not always possible.

If you do not know the frame rate of a tape, the SYNC I/O shows the incoming frame rate on its front panel LED indicators. The SYNC I/O cannot distinguish between 23.976 fps and 24 fps, or between 29.97 fps and 30 fps, but they can determine whether the incoming frame rate is drop frame or non-drop frame. With NTSC video, the frame rate is most likely 29.97 fps Drop or 29.97 fps Non-Drop.

---

## Configuring Pro Tools for SMPTE

Synchronization and MachineControl™ system settings are enabled in the Pro Tools Peripherals dialog. These settings are *system* settings, and remain constant regardless of the particular session you are working on. Configure these settings before opening a session.



*MachineControl is supported on TDM systems only.*

Other settings are configured in the Session Setup window, such as the session timecode rate, the Feet+Frames rate, the session start frame, and time display format. These settings are *session-specific* settings. These settings can only be configured when a session is open.

### Selecting a SMPTE Format

#### To choose a SMPTE format:

- 1 From a Pro Tools session, choose Windows > Show Session Setup.
- 2 Choose a frame rate (SMPTE format) from the Timecode Rate selector. (In Pro Tools 6.4, this field is labeled Timecode Rate. In Pro Tools 6.2 and below, this field is labeled Frame Rate.)
- 3 Enter the Time Code Freewheel frames (if any) in the designated box. See “Freewheel” on page 555 for more information.

## Setting a SMPTE Session Start Time (Start Frame)

The Session Setup window also allows you to set a SMPTE Start Frame for your session. Video work tapes are rarely striped beginning at a SMPTE frame address of 00:00:00:00. You can quickly enter a start time for your session based on an appropriate frame number from your project tape. The Pro Tools SMPTE-related functions (such as Spot mode) will then use this value as their reference for the session's start point.

### Start Time When Striping Tape

If you are generating time code, it is a good practice to stripe your time code beginning at 01:00:00:00 (subtracting time for initial black, bars and tone, or logos). This prevents problems that can occur with some synchronizers when the striped time code crosses from 23:59:59:29 to 00:00:00:00 (commonly referred to as the "midnight" boundary).

#### To set a SMPTE Start Time for your session:

- 1 Choose Windows > Show Session Setup.
- 2 Enter a SMPTE frame number in the Session Start field.

#### To capture an incoming SMPTE address as the session start time:

- 1 Click in the Session Start field.
- 2 Begin playback of the time code source.
- 3 At the desired location, press Equal in the numeric keypad.
- 4 Press Enter to accept the value. You can then edit the captured address. The session uses the frame number you enter as its SMPTE start frame when online.

If there are existing regions on the tracks and you are changing the original SMPTE start frame to a later time (from 00:00:00:00 to 01:00:00:00, for example), all existing regions on tracks will remain in their relative positions, but will start later by the time value added to the start frame.

5 If you are changing the session start time in an open session in which tracks already exist, a warning dialog appears after Session Setup window. Choose from one of two options:

**Maintain Time Code** Places the additional session time at the start of the session, and keeps existing regions in their original time code locations.

**Maintain Relative Position** Places the additional session time at the start of the session, and maintains the relative position of existing regions to the new start frame. For example, if you change the session start frame from 01:00:00:00 to 00:59:00:00, Pro Tools adds one minute of session time to accommodate the new start frame, and moves all existing regions earlier in time to maintain their relative position to the start frame.

#### To redefine a Timecode position:

- 1 Choose Setups > Redefine Current Timecode Position
- 2 Enter a new SMPTE frame number in the dialog.
- 3 Click OK

## Redefining a Feet+Frame Position

The Redefine Current Feet+Frame Position command lets you define a Feet+Frame number for the current insertion point.

### To redefine a current Feet+Frame position

- 1 Choose Setups > Redefine Current Feet+Frame position
- 2 Enter a Feet+Frame position to correspond to the timecode shown in the dialog.
- 3 Click OK

## Displaying Time in SMPTE Frames (TDM Systems and Pro Tools LE Systems with DV Toolkit Only)

In Pro Tools, you can set the Main Time Scale indicator to Time Code (SMPTE). Though Pro Tools will still synchronize to incoming SMPTE time code if the Time Scale is displayed in Bars:Beats, Minutes:Seconds, or Feet:Frames, it is usually more useful to use SMPTE time code as your reference.

### To set the Main Time Scale to SMPTE Time Code:

- Choose Display > Time Code.
  - or –
- Click the Main Time Scale selector in the Edit window, and select Time Code.



### Selecting a Time Scale format

Pro Tools will display time code values in the currently selected SMPTE frame rate.

## Sub Time Scale Display

You can also display a Sub Time Scale. For example, if the Main Time Scale is set to Time Code, and you want to compare SMPTE time to “wall clock,” when you are using 29.97 Non-Drop frame rate, you can select Min:Secs as the Sub Time Scale.

## Pull Up and Pull Down

Pro Tools 5.3.1 and higher supports up to 4% pull up and pull down, with support for an additional 0.1% up or down. Separate rates can be set for session audio and video (when video has been imported or captured into the session).

When referring to 4% pull up and pull down, the precise percentages used in pull ups is 4.167%. See “Audio Rates and Pull Up/Down Options” on page 561.

While the SYNC I/O is not required in order to use the extended pull up and down options provided in Pro Tools, the SYNC I/O is the only device that can be controlled from within Pro Tools, and that recalls and restores pull factors automatically when a session opens. Other synchronization peripherals must be configured manually.

 *Pull up and down settings do not affect time code generated by the SYNC I/O.*

## Configuring Pull Up and Pull Down

### To pull up or pull down audio or video:

**1** (Pro Tools 6.3 and below) If you want to use extended pull up or pull down choose Setups > Preferences, click the Operation tab, and deselect the “Limit Pull Ups to NTSC/PAL Film Standards” option.

 In Pro Tools 6.4, the “Limit Pull Ups to NTSC/PAL Film Standards” option has been removed. NTSC/Pal standards appear in bold in the list of all available pull up options.

 For more information, see “Extended Pull Up and Pull Down” on page 559

**2** Choose a Pull Up/Down Rate.

Pull Up and Pull Down controls are located in the Time Code Settings section of the Session Setup window.

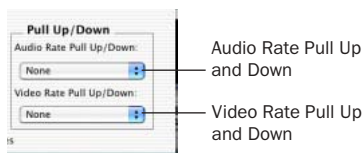

Session Setup window in Pro Tools 6.x

**Audio Rate Pull Up/Down** Controls audio sample rate. See “Audio Sample Rate Pull Up and Down” on page 560.

**Video Rate Pull Up/Down** Controls video rate. See “Video Rate Pull Up and Down” on page 561.

The choices available in these menus are determined by the session frame rate. Combinations can be applied by choosing from both menus.

 4% pull factors are not available in 176.4 and 192 kHz sessions.

The choices available in these menus are also determined by the Preferences and Auto Match Pull Factors settings in the Timecode Rate menu. (In Pro Tools 6.4, this menu is labeled Timecode Rate. In Pro Tools 6.2 and below, this menu is labeled Frame Rate.) See “Extended Pull Up and Pull Down” on page 559 and “Auto Match Pull Factors” on page 559.

## Extended Pull Up and Pull Down

**Preference and Session Setup Controls** The Audio Rate Pull Up and Down menu offers all possible combinations of pull ups and pull downs for the audio sample rate, regardless of the session frame rate.

In addition, if there is a QuickTime video clip in the timeline, the video rate can be pulled up or down by 0.1%, regardless of the session frame rate. Though not an approved workflow, earlier versions of Pro Tools also enabled pull down of QuickTime video clips when audio was pulled down, so this option is included in Pro Tools 5.3.1 and higher to maintain compatibility with earlier sessions.

## Auto Match Pull Factors

Auto Match Pull Factors is available from the session Timecode Rate menu in the Session Setup window (In Pro Tools 6.4, this menu is labeled Timecode Rate. In Pro Tools 6.2 and below, this menu is labeled Frame Rate). When

Auto Match Pull Factors is enabled, Pro Tools adjusts audio and video playback rates as needed to match any changes to the current session Timecode Rate.

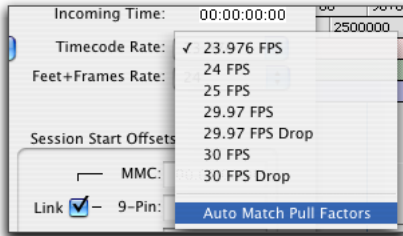

**Frame Rate menu with Auto Match Pull Factors**

Auto Match Pull is applied relative to the current pull up setting. While enabled, if the session frame rate is changed in such a way that the video would have to be pulled by an unsupported amount, the video remains unaffected.

This setting is latching, is not enabled by default, and its state is stored with the session.

### Example of Auto Match Pull Factors

Auto Match Pull Factors links audio and video pull factors when changing session frame rate.

For example, assume a Pro Tools session is set to a frame rate of 25 fps, the audio and video are both playing with no pull ups, and Auto Match Pull Factors is enabled.

If you then change the session Frame Rate to 24 fps, both the Audio and Video Rate Pull settings would change by  $-4.0\%$  (the appropriate pull setting required by the change in frame rate).

Auto Match-enabled pull factors are applied to any existing Audio Rate Pull Up/Down or Video Rate Pull Up/Down settings. For example, if audio was already being pulled  $-0.1\%$  when you changed the session Frame Rate from 29.97 to 24 fps, then the Audio Rate Pull Up/Down menu would switch to None.

### Audio Sample Rate Pull Up and Down

The Audio Rate Pull Up/Down menu applies pull up or down factors to session audio record and playback. All pull rates are available, regardless of session frame rate.

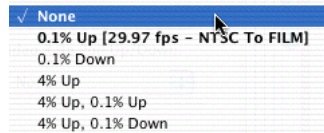

**Audio Rate Pull menu**

 See also "Auto Match Pull Factors" on page 559.



## Audio Rates and Pull Up/Down Options

The following table lists actual sample rates of each pull up and pull down option and combination (rounded to the nearest whole Hz):

*Table 36. Sample Rates at Pull Up and Pull Down Settings*

Pull Up/Down	Sample Rate					
	44100	48000	88200	96000	176400	192000
+4.1667% and +0.1%	45983	50050	91967	100100	n/a	n/a
+4.1667%	45938	50000	91875	100000	n/a	n/a
+4.1667% and -0.1%	45892	49950	91783	99900	n/a	n/a
+0.1%	44144	48048	88288	96096	176576	192192
-0.1%	44056	47952	88112	95904	176224	191808
-4.0% and +0.1%	42378	46126	84757	92252	n/a	n/a
-4.0%	42336	46080	84672	92160	n/a	n/a
-4.0% and -0.1%	42294	46034	84587	92068	n/a	n/a

## Video Rate Pull Up and Down

The Video Pull Up/Down selector lets you change the frame rate of video playback independently from the audio pull-ups (if any). It is located below the Audio Rate Pull Up/Down menu in the Session Setup window.

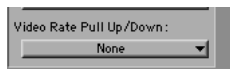

*Video Rate Pull Up/Down menu in Session Setup*

 See also "Auto Match Pull Factors" on page 559.

The choices available in the Video Rate Pull Up/Down menu depend on the file format of the video clip, as well as its frame rate. The following table shows the pull ups available for Avid video clips, both interlaced and Progressive Scan.

**Video Frame Rates and Pull Options**

Format and Video Frame Rate	Available Video Pull Rate	To synchronize with
Avid Video		
24 fps	None	
	-0.1%	29.97 NTSC videotape
	+4.167%	25 fps PAL videotape
25 fps	None	
	-4.0%	24 fps
	+4.167%	29.97 NTSC videotape
29.97	None	

Video pull rates are saved with the session.

## No Video Recording with Pull Ups

(AVoption|XL Required)

Video may not be recorded to the timeline if a video pull up is selected. If the video track is record enabled while video pull ups are enabled, or if you attempt to set a video pull up rate while the video track is record enabled, Pro Tools will post a dialog and disallow video recording. To proceed with digitization, reset the Video Rate Pull Up menu to None.

## What is Pulled Up or Down?

The following sections describe how related Pro Tools features are affected by pull up and down rates.

## Time Code Ruler

Video pull up and down does *not* affect the Time Code Ruler. Be sure to set the session Frame Rate to the correct frame rate for your project. For example, if working with 24 fps video and you pull the video up by 4%, switch the session Frame Rate to 25 fps to keep the Time Code Ruler aligned. Similarly, if working with 24 fps video that is pulled down by 0.1%, switch the frame rate of the session to 29.97.

When working with 25 fps Avid media and the video is set to pull down by 4%, set the session Frame Rate to 24 fps.

## Plug-Ins

For proper operation at larger (4%) pull rates, plug-ins must utilize sample clock instead of an absolute time clock. All Digidesign plug-ins are based on sample clock.

## Higher Sample Rates and Pull Factors

4% audio pull rates are not available in 176.4 and 192 kHz sample rates sessions.

---

## Putting Pro Tools Online

To trigger playback or recording from an external source, the Pro Tools Transport must be placed *online*. This tells Pro Tools to listen for incoming time code.

**To put the Pro Tools Transport online, do any of the following:**

- Choose Operations > Online.
- Click the Online button at the far left of the Transport.
- Press Control+J (Windows) or Command+J (Macintosh).

The Online button flashes while Pro Tools waits for a SMPTE frame to trigger playback. When time code is received, playback begins and the Online button becomes highlighted. The Location Indicators in the Edit window toolbar, and the Incoming Time field in the Session Setup window display the incoming time code (in Pro Tools 5.x, this field is labelled Current Time).

#### To take Pro Tools offline:

- Deselect Operations > Online.
  - or –
- Deselect the Online button in the Transport window.

## Recording Online

The Operation page of the Preferences dialog (Setups > Preferences) contains two options that affect how Pro Tools initiates recording when online.

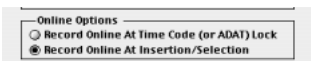

#### Online recording options

**Record Online At Insertion/Selection** Makes online recording begin wherever you have placed the insertion point in a track. Recording then continues until Pro Tools stops receiving time code. If you make a selection in a track, Pro Tools will record online only for the length of the selection.

#### Record Online at Time Code (or ADAT)

**Lock** Makes online recording begin as soon as Pro Tools receives and locks to time code or ADAT sync. In this case, you don't need to make an insertion or selection in a track to designate a start point.

---

## Generating Time Code

Using SYNC I/O, Pro Tools can generate SMPTE and MIDI Time Code (MTC). You can then make Pro Tools a master synchronization source with other devices slaved to it.

#### **SYNC I/O cannot generate 30 fps, 24 fps, or 23.976 fps time code while locked to video input or video reference**

The SYNC I/O cannot generate 30 fps, 24 fps, or 23.976 fps time code while it is locked to a video clock signal. If you set Pro Tools to generate 30 fps time code while the SYNC I/O is locked to a video clock signal, the SYNC I/O will actually generate at the NTSC color standard 29.97 fps. Pro Tools can generate time code at non-NTSC frame rates if you use the internal clock or external word clock on the SYNC I/O as a synchronization source.

#### To generate time code using SYNC I/O:

- 1** Connect the SYNC I/O LTC Out to the SMPTE in connector on the devices you are slaving. If you are slaving a device that recognizes MTC, connect the MTC OUT connector of the SYNC I/O to the MIDI IN connector of the slaved device (MIDI Interface or other).
- 2** Make sure your SYNC I/O is powered on.
- 3** Launch Pro Tools, and make sure you have already enabled the SYNC I/O in the Synchronization page of the Peripherals dialog. See the *SYNC I/O Guide* for more information.
- 4** Choose Windows > Show Session Setup, and choose the appropriate frame rate from the Timecode Rate selector (called the Frame Rate selector in Pro Tools 6.2 and lower).
- 5** Select SYNC I/O from the Generate selector in the Time Code Settings section of the Session Setup window.

6 Choose a clock reference from the Clock Reference selector. Not all clock choices are available at all sample rates. See “External Clock Sources” on page 552.)

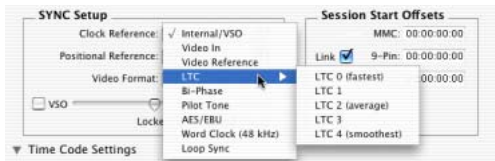

Choosing a clock reference (SYNC I/O)

7 Click the Online button on the Transport, then click Play. Pro Tools generates and outputs time code from the SYNC I/O.

---

## Using MIDI Machine Control

Pro Tools provides the capability to transmit location information to external devices, and to control their transports, using MIDI Machine Control (MMC).

### Controlling External Devices Using MMC

Any device that supports MMC (such as an Aleis ADAT or Tascam DA-88) can be controlled directly from within Pro Tools, with either the device or Pro Tools acting as clock master.

The external devices supported by Pro Tools implement “open loop” communications only. Because of this, while Pro Tools is the transport master, any direct operation of the receiving device’s transport will not be communicated back to Pro Tools. Instead, you can use the Transport pop-up to select the external device (MMC in the pop-up) and use the Pro Tools on-screen transport controls to drive the device.

Pro Tools does not support remote track arming of MMC-controlled external devices. You need to manually arm tracks for recording on the external device.

 *Digidesign’s MachineControl option supports remote track arming for Sony 9-pin and V-LAN enabled devices. See “Remote Track Arming” on page 566.*

## Windows

Pro Tools on Windows uses your Multimedia Setup to determine which MIDI devices are available, and what their properties are. Refer to your device’s installation and usage documentation to properly configure the device.

### Enabling MIDI Machine Control in Pro Tools

**To enable MIDI Machine Control:**

- 1 Choose Setups > Peripherals, then click the Synchronization tab.
- 2 Select your synchronization peripheral from the Synchronization/Device pop-up menu. If you are using a MIDI interface, select “Generic MTC Reader.” If using SYNC I/O, set the Port to DigiSerial.
- 3 Select the appropriate port for synchronization information. This is the port to which your synchronization peripheral is attached.

4 Click the Machine Control tab in the Peripherals dialog.



*Machine Control page of the Peripherals dialog*

5 In the MIDI Machine Control section, enable MMC.

6 Select your external device from the Send To pop-up menu. The list of available devices is determined by your Windows Multimedia Setup or the OMS devices configured in your OMS Studio Setup (Mac OS 9).

The port on which this information will be transmitted is set in the “ID” field. MMC commands contain an ID number to identify which machine should respond to the MMC command. There are 128 MMC ID numbers, from 0–127. The default of ID #127 is a special setting that broadcasts to all 128 MMC IDs. With this setting, any device on the specified port will respond to MMC commands.

7 Set a pre-roll time for your MMC device. Pre-roll is needed to provide Pro Tools with sufficient time to lock to the incoming time code. This value will vary depending on the external device. If the pre-roll time is insufficient, Pro Tools may not be ready to lock until after the current time code position has passed.

8 Click OK to close the Peripherals dialog. Pro Tools will now be able to control the selected device’s transport.

## Operating the Pro Tools Transport with MMC

You use the Pro Tools Transport window as the remote controller for all your enabled devices (MMC units, ADAT, or a nonlinear video deck). To do so, set the enabled devices to listen to the address you enter for MMC. The Transport window will then “drive” Pro Tools transport and any slaved devices.

You can also configure a “Pro Tools master,” which can “drive” other devices (as needed), and to which Pro Tools will chase (slaving Pro Tools).

### To control external devices from the Pro Tools Transport Master:

- Select either Pro Tools or MMC from the Transport pop-up in the Pro Tools Transport window. The selected item will act as Transport Master.



### Choosing a Transport Master

When the Transport Master is set to Pro Tools, the playback position is governed by the on-screen cursor in Pro Tools.

When the Transport Master is set to MMC, the playback position is governed by the external device’s play position.

For more information, see “Recording from MIDI Devices” on page 175.

## MMC Transport Settings

When using MMC, you can set the following options for machine transport behavior in the Operation page of the Preferences dialog.

**Machine Chases Memory Location** With this option enabled, navigating to a specific location in a session with a Memory Location causes a connected transport to chase to that location.

**Machine Follows Edit Insertion/Scrub** With this option enabled, navigating to a specific location in a session by moving the selection point or by scrubbing a track causes a connected transport to chase to that location.

---

## Synchronizing a Sequencer to Pro Tools on Macintosh

To synchronize Pro Tools 6.x to a sequencer application, configure AMS to provide MTC and MMC (if desired). Configure AMS to provide at least two nodes for inter-application communication (in the Pro Tools MIDI Setup window, these nodes are provided and are labelled Pro Tools Inputs 1 through 4).

---

## Setting Minimum Sync Delay

Lock-up time delay is the amount of time your system's devices need to achieve synchronization "lock." This amount varies for each device. Pro Tools lock up delay is set by entering a value for Minimum Sync Delay in the Synchronization window of the Peripherals dialog. The lowest value available is 15 frames. Find the shortest possible lock-up time that your equipment can operate at consistently, and set this as the Minimum Sync Delay. On systems utilizing Digidesign MachineControl, enabling the Use Serial Time Code setting will make machines lock up much faster. (Serial time code requires both the SYNC I/O and external devices to be locked to house video reference.)

### To set a Minimum Sync Delay:

- 1 Choose Setups > Peripherals, and display the Synchronization pane.
- 2 Enter a number of frames in the Minimum Sync Delay field.
- 3 Click OK to close the Peripherals dialog.

### Configuring Minimum Sync Delay for External MMC Devices Locked to House Sync

When controlling a house-synced device from Pro Tools through MMC, the device will first lock to the MMC location and then align the color framing. Within house sync code are 4 frames for ensuring color frame lock. If the minimum synchronization setup time is less than the time required to achieve both location and color frame lock, playback will begin before the device has aligned the color frames. In this scenario, you should set the Minimum Sync Delay to be more than the time required for color frame lock. This is not a problem with the SYNC I/O, which will drop out of lock until the color frame is locked.

---

## Remote Track Arming

Digidesign's MachineControl™ option for Pro Tools allows you to remotely arm tracks on supported 9-pin (or V-LAN for transport only) decks. Without MachineControl, Pro Tools does not support remote track arming of external devices. MachineControl lets Pro Tools act as the master or slave to external Sony 9-pin (or V-LAN for transport only) machines, in addition to providing remote track arming from within Pro Tools. (See the *MachineControl Guide* for more information.)

---

## MIDI Beat Clock

Some MIDI devices such as drum machines, hardware sequencers, and arpeggiators can only synchronize to MIDI Beat Clock. To synchronize these devices to Pro Tools, you can transmit MIDI Beat Clock to them. Many plug-ins also support MIDI Beat Clock.

### To transmit MIDI Beat Clock:

- 1 Choose MIDI > MIDI Beat Clock.
- 2 In the MIDI Beat Clock dialog, select the Enable MIDI Beat Clock option.



*MIDI Beat Clock dialog*

- 3 Select the devices you want to receive MIDI Beat Clock. If your MIDI interface does not support transmitting MIDI Beat Clock to separate ports, only the interface appears as a destination.
- 4 Click OK.

---

## Spotting Regions to SMPTE Frame Locations

**(All TDM Systems and Pro Tools LE Systems with DV Toolkit Only)**

*Spotting* is the process of assigning music and sound cues to specific SMPTE frame locations in a film or video. This function can be used to spot:

- ◆ Entire regions, selected with the Grabber. Multiple regions can also be selected, and Pro Tools will reference the first region in your selection.
- ◆ A specific location within a region, by clicking with the Selector at that location, and choosing Edit > Identify Sync Point.
- ◆ Sessions or tracks, dragged from a browser to the session Timeline or Regions List.

## Spot Mode

In Spot mode, a region in a track can be quickly spotted by simply clicking it with the Grabber.

You can also drag a region from a DigiBase browser, or from the Regions List, to a track while in Spot mode.

## The Spot Dialog

The Spot Dialog appears when you drag a region to a track or click a region with the Grabber in Spot mode. The numeric fields function as both data displays and editing controls for the currently selected regions.

Information in these fields is displayed in SMPTE Time Code, Minutes:Seconds, Feet.Frames, Samples, or Bars & Beats, depending on which Time Scale format is selected.

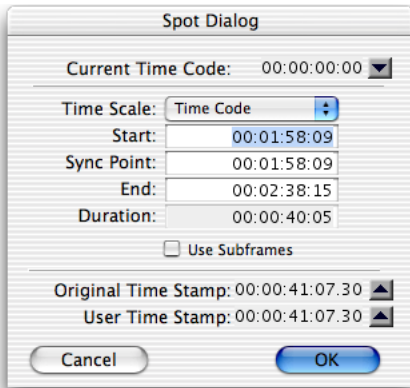

#### Spot dialog

A highlighted numeric field indicates the current active field for numeric entry editing. Entering a value in a field allows you to move a selected element to the time location that you enter. The Start, Sync Point and End fields are accessible when the Grabber is active. Only the Start or End (depending on where you click the mouse) and Duration fields are active when the Trimmer is active (see “Using the Trimmer in Spot Mode” on page 570).

 To increase or decrease SMPTE values in the Spot dialog by a specific number of frames, press plus or minus on the numeric keypad, enter a number, and press the Enter key.

## Use Subframes Option

A subframe is 1/100th of a frame. The Use Subframes option enables you to use these smaller units for greater accuracy. This command adds an additional time field in the SMPTE hours:minutes:seconds:frames box, which appears as the far right time field when enabled. Use a period to separate subframe values from whole frames.

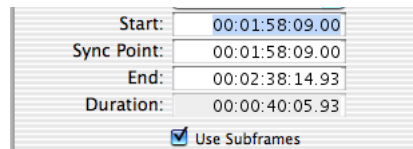

Additional time field with “Use Subframes” enabled

 Subframe measurements are not available in the Current Time field.

## Capturing Time Code

Pro Tools also allows you to easily capture frame locations on-the-fly in this dialog by pressing the Equal key, or by clicking the Current Time button while valid time code is being received by Pro Tools. With VITC, you can accurately capture a paused or “crawling” VTR’s SMPTE location.

When Time Code is selected for the Time Scale, pressing the Equal key captures the incoming time code. When Bars:Beats is selected for the Time Scale, pressing the Equal key will capture to the nearest measure.

Although the Capture Time Code button works with free-running Linear Time Code (LTC) or VITC, frame numbers of a paused frame can only be captured with VITC.



The SYNC I/O can read VITC. With MachineControl and SYNC I/O, you can also read serial time code.

 *To use Remote mode with MachineControl, you will need an approved serial port. For a complete list of currently approved ports, see [www.Digidesign.com](http://www.Digidesign.com).*

#### **To spot a region to a specific SMPTE frame:**

- 1 Choose Display > Show Edit Window.
- 2 Set the Main Time Scale to time code. (See “Setting a SMPTE Session Start Time (Start Frame)” on page 557.)
- 3 Click the Spot button at the top left of the Edit window to put Pro Tools into Spot mode.



#### **Spot mode enabled**

- 4 Identify the SMPTE frame location where you want to trigger playback of your region by pausing your video deck on that frame.
- 5 With the Grabber, click a region in a track, or in the Regions List, and drag it into a track. The Spot dialog appears.
- 6 Enter the SMPTE frame location.
  - If you are using VITC, you can press the Equal key on the numeric keypad, or click Current Time Code to enter a paused VTR's current SMPTE location.
  - If you are using LTC, when Time Code is selected for the Time Scale, press the Equal key on the numeric keypad to capture the incoming time code. When Bars:Beats is selected for the Time Scale, press the Equal key to capture the nearest measure.

7 If you recorded the region while online, you can use the Original Time Stamp button to recall and enter the SMPTE frame location at which the region was originally recorded. You can also access a user-defined Time Stamp in the same fashion. See “Time Stamping” on page 570 for more information.

8 Click OK to close this dialog. The region spots to the chosen SMPTE frame location. When the session is online, this frame number will trigger playback of the region.

## **Auto-Spotting Regions**

The Pro Tools Auto-Spot Regions option simplifies the task of spotting regions even further. If you are using VITC with this option enabled, or MachineControl software, you can pause your video at an appropriate SMPTE frame location, click a region with the Grabber, and the region will be automatically spotted to the current time code location.

You can also use MachineControl's serial time code ability to auto-spot by enabling MachineControl and enabling serial time code in the peripheral.

#### **To Auto-Spot a region:**

- 1 Choose Operations > Auto-Spot Regions.
- 2 If you are using VITC, identify the SMPTE frame location where you want to trigger playback of your region by pausing your video deck on that frame.

**3** Click the region with the Grabber. The region will be automatically spotted to the current time code location (or machine location).

 *Clicking a region with the Trimmer will allow you to trim the region to the current time code location.*

 *Auto-spotted regions are spotted by their start times, unless you have identified a Sync Point (see “Identifying a Synchronization Point” on page 572). If the region contains a Sync Point, the region is spotted to it.*

## Using the Trimmer in Spot Mode

You can use the Spot dialog to trim your regions, including start/end/duration times and referencing incoming time code addresses. If you click a region with the Trimmer in Spot mode, the Spot dialog will appear, allowing you to enter a value in the Start or End and Duration fields to specify exactly where you want to trim the region’s beginning or end. Use this to edit the length of a region to correspond to a particular visual “hit point.”

Trimming a region that contains a sync point (see “Identifying a Synchronization Point” on page 572) will not affect the SMPTE location of the sync point, unless the region is trimmed past the sync point.

---

## Time Stamping

Pro Tools time stamps every region recorded online with the original SMPTE time at which audio was recorded. You can recall this original SMPTE time for a region by clicking the Original Time Stamp button in the Spot dialog.

You can also spot a region to a separate user-defined SMPTE time stamp, defined using the Time Stamp Selected command. Once the region is time stamped using this command, you can click the User Time Stamp button to re-spot a region to its user-defined SMPTE location.

## Show Original Time Code in Regions

This command displays the original “time stamped” SMPTE times in all regions currently placed in tracks. This SMPTE frame number represents the time at which the region was originally recorded online with Pro Tools, and does not necessarily reflect the region’s current SMPTE location in a track.

### To display Original Time Stamps in regions:

- Select Display > Display Time in Regions > Original Time Stamp.

### To hide Original Time Stamps:

- Select Display > Display Time in Regions > None.

## Creating a User Time Stamp

If you want to create a separate user-defined SMPTE time stamp, you can use the Time Stamp Selected command in the Regions List pop-up menu. This command allows you to select a region (or regions) and redefine its SMPTE time stamp. The Original Time Stamp and the User-Time Stamp are then stored with your session.

When audio is first recorded, the User Time Stamp will match the Original Time Stamp, but you can change the User Time Stamp at any time using the Time Stamp Selected command. This feature is particularly useful in post production situations where the SMPTE time code on video “work prints” often changes from one edit revision to another.

### To time stamp a region (or regions) with a new SMPTE frame number:

- 1 In a track, select the region that you want to time stamp.
- 2 From the Audio Regions List pop-up menu, choose the Time Stamp Selected command.

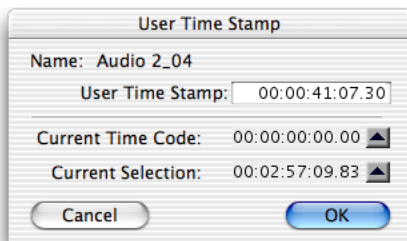

### Time Stamp Selected command

- 3 Enter a new SMPTE time. You can do this in three ways:
  - Enter the numbers manually (with the help of the arrow keys).
  - or –

- Click the Current Time Code button (or press the Equal key), if you want to capture the incoming time code address.
- or –
- Click the Current Selection button, if you want to enter the start time of the current on-screen selection.

- 4 Click OK to close this dialog.

This command can be used in “batch mode” to set new time stamps for several regions at a time. To do this, simply select several regions and choose the Time Stamp Selected command. One after another, a dialog will open for each region, allowing you to quickly enter new values.

Once entered, the user time stamps can be displayed in all regions currently placed in tracks.

### To display User Time Stamps in regions:

- Choose Display > Display Time in Regions > User Time Stamp.

### To hide User Time Stamps:

- Choose Display > Display Time in Regions > None.

## Pro Tools 5.x and Using a Region with User Time Stamp in Another Session

With Pro Tools 5.x, user time stamp information is saved for each region as part of a session—not as part of the audio file itself.

### To use a time-stamped audio file in another session, and keep its time stamps intact:

- 1 Open the session that contains the original time-stamped region.
- 2 In the Audio Regions List, select the region you want to export.

- 3 From the Audio Regions List pop-up menu, choose Export Selected As Files.
- 4 From the Export Selected dialog, configure export options.

 For more information on Export Selected options, see “Exporting a Region as a New Audio File” on page 121.

- 5 Click Export to export the new audio file.

The region can now be used in other sessions with its original time stamp references intact.

---

## Identifying a Synchronization Point

The Pro Tools Identify Sync Point command allows you to identify a specific point within a region for audio spotting purposes.

Imagine the following sound effects spotting scenario: You have a single sound effect that consists of a creaky door slamming shut, followed by a few seconds of ambient reverberation. The slam portion of the effect—which you must precisely match to picture—occurs neither at the very beginning of the audio file nor at the very end. It is somewhere in the middle, making it tough to spot.

In this scenario, use the Identify Sync Point command to create a point in the region and synchronize that point to a SMPTE frame.

### To create a sync point in a region:

- 1 Click with the Selector at the point in the region that you want to synchronize to a SMPTE frame location.

– or –

To place the edit cursor during standard playback mode (not Continuous, Playhead, or other), press the Down Arrow key while playing back.

- 2 Choose Edit > Identify Sync Point. The current SMPTE time is automatically entered as the SMPTE location for the sync point. An arrow indicator appears in the audio region indicating the location of this sync point.

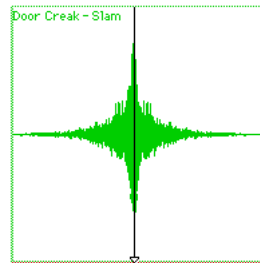

*Identifying a Sync Point in a region*

---

## Troubleshooting Synchronization

Getting SMPTE synchronization to work properly can seem like a formidable task at times. The following suggestions may help you troubleshoot and solve common problems.

### Use the Incoming/Current Time Field in the Session Setup Window as a Reference

The Current Time field in the Session Setup window indicates whether or not Pro Tools is receiving time code. If this field appears to be inactive when inputting time code into your time code reading device, check your hardware device settings, the device's connection to your computer, and your OMS Setup (Mac OS 9) or Multimedia Setup (Windows).



*When using MachineControl, the Current Time field will display 9pin code, even though the LTC device may not be connected.*

### Stripe SMPTE Before You Record

All tapes in your setup (both audio and video) must be striped with SMPTE Time Code before any audio is recorded onto them or to Pro Tools. If tapes aren't striped, your system may seem to work, but synchronization will never properly occur. The machines and Pro Tools will drift farther and farther apart the longer they run.

The same problem occurs when audio is recorded into Pro Tools without a resolved SMPTE source (for example, if it was recorded before the current session). The audio cannot be accurately synchronized with an analog tape recorder or video tape deck, since the Pro Tools audio was not recorded referenced to the SMPTE time code from the analog tape deck or video tape deck.

### Resolve All Components of Your System

When striping time code, make sure that the time code generator and the video record deck are resolved to the same crystal reference. For example, when striping 29.97 Drop Frame time code onto a VTR, both the SMPTE generator and the VTR should be resolved to the same "black burst" or house sync generator. During playback, the master deck should be resolved to "black burst" or house sync.

This convention provides compatibility for your tape between the record and playback passes, and when it's played back in other facilities on different equipment. This also means that when playing back a tape striped with time code, the playback deck should be resolved to the same synchronization rate as the record deck was resolved to at the time of the striping. When you stripe time code using an audio transport, it should be "free-running" and unresolved, but should be resolved with a house sync-referenced synchronizer during playback.

### Know the True Frame Rate on Your Work Tape

If you get your video tapes from a production company instead of recording them yourself, be absolutely sure that they indicate the SMPTE frame rate used on the tape correctly. Several time code formats use the same frame count (such as 23.976 fps and 24 fps) yet they run at slightly different frame rates per second.

The Digidesign SYNC I/O (and some third-party products) can be used to help determine frame rate. See "Determining SMPTE Frame Rate" on page 556.

### **29.97 fps Non-Drop Rate Not Recognized**

29.97 fps Non-Drop is a slightly slower version of 30 fps Non-Drop time code. When used with color video, each video frame now matches up with each SMPTE frame without having to use a drop-frame coding. This makes any frame number mathematics much simpler, since no frame numbers are dropped.

Unfortunately, some hardware and software devices do not recognize 29.97 Non-Drop as a separate frame rate. For example, any standard SMPTE-to-MTC-converter does not explicitly recognize it. The user must tell the converter to expect 30 fps Non-Drop instead. In fact, many devices that read SMPTE work acceptably by reading 29.97 Non-Drop if they are set to expect 30 fps Non-Drop.

Any SMPTE reader that uses the time code numbers to make real-time calculations (as Pro Tools does when it tries to trigger and synchronize to SMPTE) also needs to know that the frame format is 29.97 and not 30 fps. Since Pro Tools allows this choice of frame rate this does not really pose a problem. The problem exists because many users cannot readily distinguish 29.97 from 30 fps.

Even though NTSC tapes only use 29.97, some production companies will distribute video work prints striped with 29.97 fps but mark them as “30 fps NTSC,” by which they actually mean 29.97 fps Non-Drop.

By the time you get the tape, you may have no idea what’s actually on it. Feeding 29.97 Non-Drop to Pro Tools when it’s set for 30 fps Non-Drop will result in timing errors of about 1.8 frames per minute, causing audio playback to trigger out of sync.

### **Be Careful When Changing Frame Rates**

If you change time code rates in the middle of a session, many SMPTE-to-MIDI Time Code converters need to be turned off and turned on again to be able to recognize the new frame rate.

### **Use a Consistent Clock Source**

When possible, sound files should be played back using the same sync reference signal it was recorded with. This assures the closest match between record and playback sample rates.

### **Disable Screen Savers and Power Management Features**

These types of software can cause your computer to ignore MIDI data (such as MIDI Time Code).

# Chapter 36: Working with QuickTime Movies

You can use Pro Tools to import QuickTime movies and audio (such as MP3s), perform audio post production tasks, and export the finished product as a new QuickTime movie.

---

## About QuickTime

QuickTime is digital video technology designed to produce compact video files for multimedia use.

## Using QuickTime Movies in Pro Tools

Pro Tools allows you to import QuickTime movies into your Pro Tools sessions.

Once imported into Pro Tools, a QuickTime movie is displayed in its own Movie track in the Edit window, and in a floating Movie window. This floating window can be viewed on a second monitor with appropriate video hardware (including FireWire output of QuickTime DV). With a QuickTime movie in the session,

Pro Tools serves as a fast, random-access visual reference for “sweetening” the movie by adding sound effects, music, foley, dialog, or other audio.

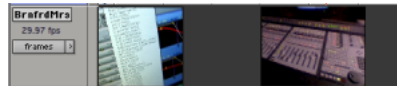

*Pro Tools Movie track displayed as frames*



*Pro Tools Movie window*

Pro Tools provides precise, frame-accurate audio and video synchronization. This means you can use your Pro Tools system as an off-line audio editing system, leaving the video editing suite free for video editing.

With Pro Tools, you can:

- ◆ Import a QuickTime movie into a session
- ◆ Import audio from a QuickTime movie
- ◆ Import audio files from a CD or a CD-ROM
- ◆ Import audio from an audio CD (Macintosh only)
- ◆ Synchronize audio events to a QuickTime movie, using the Pro Tools editing features to spot and nudge regions to video frames
- ◆ Scrub audio elements in tandem with a QuickTime movie
- ◆ Use the Pro Tools Bounce to QuickTime Movie command (Pro Tools 6.1 and higher) or Bounce to Movie command (Pro Tools 6.0.x and lower) to compile a new “flattened” QuickTime movie file that can be read by any QuickTime-compatible application

If you want to edit or in any other way modify a movie, return to your video capture and assembly software (such as Avid Xpress DV) for editing, then import the edited movie into Pro Tools.



*You can capture Avid-compatible video in Pro Tools with AVoption, AVoption|V10, or AVoption|XL.*

## Video Capture/Playback Cards

For professional applications where full-screen, 25/30 frames-per-second playback is critical, we recommend that you invest in a Digidesign-approved third-party video capture and playback card, or an external DV Firewire device.

For more information on compatible video capture cards, visit the Digidesign Web site.

## If You Are New to Audio Post Production

If you are new to digital video, time code, or audio-for-post production, the following suggestions will help you manage your session’s audio and video requirements. Not all of these may apply to every project.

**Plan Ahead** Think through your entire project before you start capturing your video. For best results when working with SMPTE time code, make sure that time code is burned into a window in the movie. Try to anticipate compatibility and configuration issues that may arise.

**Make Sure your Movie is Conformed** Be sure to conform your captured QuickTime movie to the desired frame rate. Consult your video capture software’s documentation for information on how to ensure frame-accurate captures. We recommend that you do this to all video captures to ensure accurate playback in Pro Tools.

With Pro Tools 5.2.x and lower, if your destination is a pulled-down Pro Tools session, this pull down affects QuickTime movie playback speed. You should conform your movie to a 30 fps frame rate for use in a pulled-down session.

**Destined for Video or Film?** What is the ultimate destination of your work? Is it for DVD, HD, TV, film, audio CD or CD-ROM? This will determine such things as the best sample rate to use, the correct timecode rate, and pull-down or pull-up rates. Double-check the time code frame rate. You must make sure that you know the correct frame rate of the video source.

**Storage** Make sure you have enough disk space on your drive, and optimize your hard drives regularly.



**Video Compatibility** If you are not digitizing the video material yourself (if the material is already on hard disk) check into the type of video capture and playback system that was used and make sure you can accommodate that format's compression method. Check whether or not time code is "burned into" or superimposed over a small area of the video.

---

## QuickTime Requirements

Pro Tools supports playback of QuickTime videos without additional hardware. However, with older Macintosh computers that had video inputs, performance will vary in terms of maximum movie size, frame rate, and smoothness of playback. Capture of 30/25 fps (frames per second), 60/50 fields-per-second video requires a video capture card, and associated software and hardware.

### About Frame Length and QuickTime Movies

Not all video capture software can guarantee consistent frame lengths. Refer to your video capture software documentation for information on ensuring frame-accurate captures, and on conforming your video to proper frame boundaries.

To take advantage of Pro Tools QuickTime movie playback capabilities, you will need the following:

- ◆ A Digidesign-qualified version of Apple's QuickTime System Extension. Refer to the Digidesign Web site ([www.digidesign.com/com-pato](http://www.digidesign.com/com-pato)).
- ◆ QuickTime movie playback and editing software (such as Avid XPress DV) to edit and compile QuickTime movies.

Optionally, you may also need:

- ◆ QuickTime movie capture hardware and software to digitize your own movies from a video tape or video camera source.
- ◆ A DVD or CD-ROM drive to take advantage of commercially-available QuickTime movies and sound clips.

---

## Movie Playback Quality Options

Pro Tools supports three options for movie playback performance: Normal Priority Playback, Medium Priority Playback, and Highest Priority Playback. In most cases, you should leave the priority choice set to Normal Priority Playback. If you are running QuickTime Movies *natively*, that is, without a capture card, you may need to use one of the other playback priority options. If this does not apply to you, leave movie playback priority set to Normal Priority Playback. This is the default setting.

 See also "Firewire Playback of QuickTime DV Movies" on page 579.

### Hard Drive Tips for Best Performance

If possible, connect the hard drive you are using for video capture and playback on a different SCSI, ATA/IDE, or FireWire bus from the drive with your audio files. This minimizes interference between drives when Pro Tools requests audio and video data. With most capture cards, and moderate data capture rates (800 kilobytes per second or less), this should provide good performance.

For complete information on hard drive requirements, visit the Digidesign Web site.

---

## Importing a QuickTime Movie

Before you import a movie, you should digitize your video material and know the correct frame rate and sample rate when applicable.

**⚠** *If a video card with hardware video compression was used to create the QuickTime movie, Pro Tools cannot play the movie without the compression hardware. Make sure the video card is installed and configured correctly before starting your session.*

### To import a QuickTime movie into Pro Tools:

- 1 Launch Pro Tools and create a new session, or open an existing one.
- 2 Check the time code settings of the session to make sure they match those of the movie you want to import, and save the session.
- 3 Choose **Movie > Import Movie**.

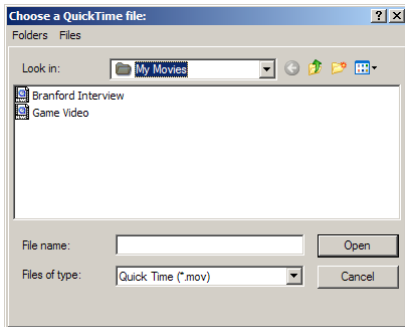

**Import Movie dialog**

4 Select the movie and click **Open**. Pro Tools imports the movie and displays it in its own Movie track in the Edit window as well as in a floating Movie window. The first frame of the movie is automatically placed at the start time of your session.

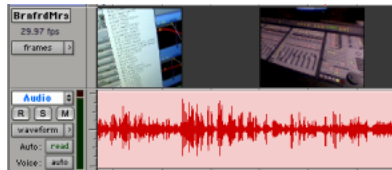

**Movie track above an audio track in the Edit window**

## About the Movie Track

Once a movie is imported into Pro Tools it appears in the Edit window in its own Movie track. Depending on the setting of your Movie track view, the movie displays as blocks, or as a picture-icon (picon) “thumbnail” overview of the frames of the movie it represents. The Movie track will show greater or lesser detail depending on your current zoom level in the Edit window—the closer in you zoom, the greater the number of individual frames that are displayed in the Movie track; the farther out you zoom, the fewer the number of individual frames that are visible.

The Movie track behaves much as a Pro Tools audio or MIDI track in that you can move the movie region with the Grabber or other editing tools. This allows you to offset the movie to any start point. However, you cannot edit the Movie track by trimming it or capturing regions from within it.

Only one QuickTime movie can be associated with a session at a time. If you want to import a different movie into a session, repeat the previous steps. The new movie will replace the original in the session. A Movie track takes its name from its associated movie file and cannot be independently renamed.

### Frames View Performance

When using Frames View to view movie content in the Movie track, your computer may exhibit reduced or sluggish performance. If this happens on your computer, switch the Movie track view to Blocks mode.



*You can also hide the movie track to further optimize performance, if necessary.*

---

## Firewire Playback of QuickTime DV Movies

With the addition of an external DV transcoder (decoder), you can play QuickTime DV Movies out through your computer's Firewire port. These can include QuickTime movies exported as QuickTime DV from Avid Xpress DV.

**TDM Systems** Requires Pro Tools 5.3.1 or higher.

**LE Systems** Requires Pro Tools 6.x.

For the latest compatibility information on Firewire transcoders, see the Digidesign Web site. For specific information about the Canopus Transcoder, check the Canopus Web site (<http://www.canopuscorp.com>).

QuickTime DV performance may vary, depending on the specifics of your system and projects.

## Supported QuickTime Movies

**Referenced and Consolidated Media** Exported QuickTime DV movies can be either complete Quicktime files (where media is copied into a Quicktime file) or Quicktime reference files (where just a small composition is in the Quicktime file which references the original DV files).

**Codec Requirements** When exporting from Avid Xpress DV, always use the Apple DV codec. Do not enable "Use Avid Codec" in the export dialog. If an Avid-codec DV movie is imported into Pro Tools, you will not be able to play it.

**DV Stream Movies** Pro Tools does not support audio from a DV Stream file. DV Stream files contain the entire data stream that's been transferred or recorded over the FireWire cable from a camera. In this type of file, the audio and video data are stored in an interleaved fashion, as opposed to a QuickTime file where audio and video are stored separately.



*See also "Exporting QuickTime DV from Avid" on page 580.*

### To Play DV Movies through the FireWire Port:

- 1 Import a QuickTime DV movie into a Pro Tools session by choosing Movie > Import Movie.
- 2 Choose Movie > Play DV Movie Out Firewire Port.

When this item is enabled, Pro Tools will play DV movies (NTSC or PAL) out the FireWire port to an external DV decoder. This can improve system performance by removing the need for the movie to be software decompressed by the CPU and displayed on the computer screen.

If the desktop Movie Window is open when video is playing out the FireWire port, it will display the text "DV Movie Is Playing Out FireWire Port."

## Delay Between Video & Audio

There can be a considerable delay between video and audio playback when using this feature.

### To compensate for delay between audio and video playback:

- 1 Choose Movie > Set Movie Sync Offset.
- 2 Enter a value appropriate to align the audio with video.

Generally, you will need to set this value once for each type of DV decoder used.

 For a list of Digidesign-qualified video capture cards and transcoders, see the Digidesign Web site ([www.digidesign.com/compato](http://www.digidesign.com/compato)).

## Exporting QuickTime DV from Avid

The following instructions list export settings for Avid XPress DV. These settings are required to create QuickTime DV movies that can be played back in Pro Tools through the Firewire port.

### To export a QuickTime DV reference movie for Pro Tools Firewire playback, set the following:

- 1 Enable the following export options:
  - Flatten video tracks
  - Fill in spaces with black
  - Render all video effects
  - Use Apple DV Codec
  - Enable the Apple DV codec
- 2 Make sure Use Avid Codec is not enabled.

 These export settings can be saved in Avid XPress DV3.0 as a default, simplifying future media exchange. Refer to your Avid XPress documentation for more information on export settings and defaults.

## Scrubbing the Movie Track

You can use the Scrubber tool to scrub the Movie track with full frame accuracy. If you scrub directly on the Movie track, only the movie will scrub (no audio will play). If you scrub on an audio track, audio and the movie will scrub simultaneously.



### Scrubbing a movie track

#### To scrub the Movie track:

- 1 Select the Scrubber tool.
- 2 Click in the Movie track and drag the Scrubber.

 To scrub with finer precision, press the Command key while scrubbing

---

## About the Movie Window

The Movie window displays the movie playback or the current frame if playback is paused or stopped. You can drag the Movie window anywhere on your computer screen.



Movie window

### To display the Movie window:

- Choose Window > Show Movie Window. If a movie has already been imported, the Movie window will appear.

 See also “Firewire Playback of QuickTime DV Movies” on page 579.

### Using a 14-inch Monitor for Playback

If you capture 320 x 240 (NTSC) movies and have a second monitor with 640 x 480 resolution (a standard 14-inch monitor), clicking on the Movie window will route movie playback to that monitor. The Movie will “bounce” over to the second monitor, and will be pixel-doubled so that it takes up the whole screen.

## Tips for Optimizing Movie Playback

Since Pro Tools uses QuickTime to play movies, the quality of the playback is dependent on the speed of your computer and hard drive, the size (in pixels) of the movie, and the quality of the video hardware used to capture and play back the digitized video. While QuickTime doesn’t produce broadcast-quality playback, it is frame accurate when spotting to picture.

On PCI-based computers, Pro Tools continuously re-syncs the movie. The movie resolves to the audio sample clock. This allows the movie to smoothly track the audio even when your system is varispeeeded.

For more consistently smooth movie playback, here are some suggestions:

- ◆ Use a Digidesign-approved video capture and playback card for 25/30 frames-per-second full-screen movie playback.
- ◆ Display the movie on a separate monitor driven by a video capture and playback card.
- ◆ If you don’t have a video capture and playback card, set the movie playback priority to Medium Priority Playback or High Priority Playback using one of these commands in Movie menu. This gives priority to movie playback, rather than other screen graphics tasks such as moving faders.
- ◆ Use the fastest computer possible.
- ◆ Capture and play QuickTime video from a separate hard drive than your Pro Tools audio drives.
- ◆ Remove unneeded System Extensions and Control Panels (Mac OS 9).
- ◆ Disable the Automation Preference for Faders Move During Playback.
- ◆ Set No Auto Scrolling in Operations > Scroll Options.

- ◆ Reduce the size of the Edit window to the smallest possible size.
- ◆ Close unnecessary windows.
- ◆ Reduce the overall length of the SCSI chain of your computer system for improved throughput.
- ◆ Reduce the pixel size of the movie (for example, reduce it from 640 x 480 pixels to 320 x 240 pixels).
- ◆ Hide the video track when not needed.
- ◆ When using video capture cards or transcoders to play back externally to the computer monitor, it may be necessary to keep the QuickTime window open in order to output the movie. In these cases, you can improve screen management by keeping the movie small and out of the way on your computer monitor.

**To reduce the size of the QuickTime window using QuickTime Player:**

- 1 Close the session.
- 2 Open the movie in QuickTime Player, and resize the movie so it is very small.
- 3 Choose Save, then Quit QuickTime Player.
- 4 Open the session, and move the QuickTime window away from any Pro Tools windows.

---

## Setting the Movie Start Time (Movie Offset)

When you import a movie into your session, the first frame of the movie defaults to the start time of the session. In some cases, however, you may need to offset the movie by some amount forwards or backwards so that you can accurately spot audio to the movie.

Since a movie can be moved inside the Movie track, it is fairly easy to match these two times. In fact, you may not have to move the Movie track at all.

For finer adjustment of a movie's start time, you can use the Set Movie Sync Offset command to offset the movie in 1/4-frame increments. This is more accurate than dragging the Movie track, and is especially useful in cases where your movie track happens to begin with a partial frame.

**To set the movie offset:**

- 1 Double-check that the session's SMPTE frame rate matches that of the movie.
- 2 Choose Movie > Set Movie Sync Offset, enter an offset value, and click OK.



*The Movie Sync Offset is always defined in quarter frames, regardless of the session time display.*

- 3 Lock the movie in place by choosing Edit > Lock/Unlock Region.

**To spot the movie to a sync point:**

- 1 Double-check that the session's SMPTE frame rate matches that of the movie.
- 2 In the Edit window, enable Grid mode.
- 3 Set the session time display to SMPTE.
- 4 Set the Grid Value to Time Code.
- 5 With the Selector, click in the Movie track to place the cursor where you want to create a Sync Point. Often, the best spot will be the "2 beep" two seconds before the first action frame (the start of the video). You can use the plus and minus keys on the alpha keyboard to nudge the cursor and the movie one frame at a time.

6 Choose Edit > Identify Sync Point to place a Sync Point at the current cursor location.

7 Enable Spot mode by clicking the Spot button in the Edit window.

8 Click the Movie track with the Grabber. The Spot dialog appears.

9 Enter the time code number displayed in the window-burn of the frame you are spotting to (if the movie has a SMPTE time code window burned into it) and click OK.

The movie's sync point moves to the SMPTE location you entered.

---

## Spotting Audio to a QuickTime Movie

For accurate spotting, Grid mode provides you with an effective tool for quick and accurate selection of waveforms, and alignment of regions in tracks. When Grid mode is enabled, the Selector will snap to the current Grid Value, and regions selected with the Grabber and dragged to a track will also align up with the Grid Value.

### Make Sure Your Movie is Conformed

Before you spot audio to a movie, you should make sure the movie file is conformed so that each frame starts and ends at valid frame boundaries. The movie should be conformed to a time-code rate that Pro Tools can work with (30 fps or 29.97 fps).

**▲** *In Pro Tools 5.2.x and lower, if your destination is a pulled-down Pro Tools session, the pull down affects QuickTime movie playback speed. Make sure your movie is conformed to a 30 fps timecode rate for use in a pulled-down session.*

Consult your video capture software documentation for more information.

### More Tips for Spotting Audio

◆ Specify your movie size up front. For purposes of spotting audio, 320 x 240 is usually adequate. If you are displaying the movie on a second monitor with 640 x 480 resolution, with pixel doubling, it will fill the screen.

◆ Try to work with a window burn in the movie, since it will help you spot material. You can produce your own window burns for the capture using Digidesign's SYNC I/O.

◆ Use a continuous scrolling option. Pro Tools includes two scrolling options that are particularly useful in post production: Continuous Scroll During Playback, and Continuous Scroll with Playhead. Enable either of these scrolling options by selecting them from the Operations > Scroll Options submenu.

**▲** *Continuous Scroll options require more CPU power, and may degrade the quality of your movie playback.*

### Using Grid Mode to Spot and Nudge Regions with Frame Accuracy

**(All TDM Systems and Pro Tools LE Systems with DV Toolkit Only)**

Grid mode allows you to constrain the movement of regions so that they snap to SMPTE-based measurements (minutes, seconds, frames, or subframes).

### To spot audio to a movie:

- 1 Click the Grid button at the upper left corner of the Edit window. This ensures that the audio will align to a frame boundary.
- 2 Set your Grid Value to Time Code using the pop-up menu.
- 3 Choose a desirable Grid unit setting. Note that you can set the grid units independently of the Main Time Scale.
- 4 Using the Selector, place the insertion cursor at a location in the movie. If you want, use the Nudge Value pop-up to set the nudge units to frames. You can then use the plus and minus keys on the alpha keyboard to nudge the insertion point frame by frame.
- 5 While pressing the Control key, drag a region from the Regions List to the appropriate track. Pro Tools will automatically spot the region to the same time location as the cursor.



*To spot elements directly to locations in the movie, use the technique described above. In this scenario, Auto Spot mode is not recommended, since it uses incoming MTC for location information.*

---

## Importing QuickTime Audio (and Other Compressed Video Files)

Pro Tools allows you to import audio directly from a QuickTime movie. You can import audio from a movie currently loaded into a session, or from a different movie. The procedure is the same for both.

Pro Tools supports the following compressed QuickTime file formats:

- ◆ MP3
- ◆ QDesign
- ◆ uLaw 2:1
- ◆ aLaw 2:1
- ◆ Intel ADPCM
- ◆ Microsoft ADPCM
- ◆ IMA 4:1
- ◆ 32-bit floating point
- ◆ 64-bit floating point
- ◆ 16-bit Big Endian
- ◆ 16-bit Little Endian
- ◆ MACE 6:1
- ◆ MACE 3:1

QuickTime files can be imported into sessions using either Import Audio from Other Movie or Import Audio from Current Movie menu commands.

## Sample Rate Conversion Quality

If you import QuickTime audio that was not originally recorded at the session's sample rate, the sample rate is converted to match the audio to your session. Pro Tools allows you to choose the quality of the sample rate conversion by means of the Conversion Quality setting in the Editing Preferences. The higher the quality of sample rate conversion that you choose, the longer it takes to perform the sample rate conversion.

The five conversion settings range from Low to Tweak Head. The Low setting provides results that are considerably better than the Macintosh's built-in sample rate conversion. For most applications, the Better setting will yield excellent results.



Because the Best and Tweak Head settings take significantly longer than the others, we recommend that you use these only in cases where the highest fidelity is absolutely essential and you have a considerable amount of time. The Tweak Head setting in particular can take several hours to perform sample rate conversion on moderate-length files.

**To set the sample rate conversion quality:**

- 1 Choose Setups > Preferences and click Editing.
- 2 Click the Conversion Quality pop-up menu and select a conversion setting.

## Importing Audio from a QuickTime Movie

You can use the Import Audio From Current Movie and Import Audio From Other Movie commands to import audio tracks from a QuickTime movie currently in the session. To import audio from other QuickTime movies on your hard disk or on CD (Macintosh only), you can also drag and drop tracks from the DigiBase browser.

 To use DigiBase to import audio from CDs with drag and drop, see “Importing Audio Files with Drag & Drop from a DigiBase Browser” on page 113.

*For additional details on using DigiBase, refer to the DigiBase Guide.*

**To import audio tracks from a QuickTime movie:**

**1** If you want to import audio from a QuickTime movie that is already in the session, choose Movie > Import Audio From Current Movie.

– or –

If you want to import audio from a QuickTime movie that has not been imported into the session, choose Movie > Import Audio From Other Movie.

**2** Select the QuickTime movie from which you want to import audio. The Track Import dialog appears, listing information about the audio tracks.

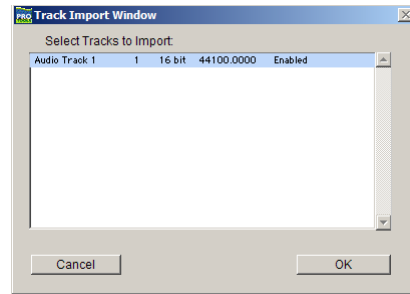

*Track Import window showing audio track in a QuickTime movie*

**3** Select the audio tracks you want to import by clicking them. To select multiple tracks contiguously in this dialog, Shift-click them. To select discontinuous tracks, Command-click them.

**4** Click OK. The audio is converted to the session’s sample rate and bit resolution, and a new region appears in the Audio Regions List for each imported file (two regions appear for each imported stereo file). The regions are listed in the Audio Regions List with the region name, the number of the originating track, and the number of the region from the track.

**5** Drag the imported regions from the Audio Regions List to tracks in your session.

## Bouncing to a New Movie

When you have finished your final mix and synchronized your audio events to the movie, you can use the Pro Tools Bounce to QuickTime Movie command (Pro Tools 6.1 and higher) or Bounce to Movie command (Pro Tools 6.0.x and lower) to compile a new QuickTime movie with the bounced audio embedded in the QuickTime movie file as the soundtrack. As a QuickTime file, the new movie is supported by all software applications that support QuickTime video.

### To create a new QuickTime movie with bounced audio embedded as the soundtrack:

- 1 Adjust track output levels and finalize your mix. Any inserts and effects settings that are active on tracks will be permanently written to the bounced tracks.
- 2 Make sure that what you are hearing is what you want to bounce, and that your “bounce-to-disk” output assignments correspond to the outputs you are listening to.
- 3 If you want to bounce the entire session, press the Return to Zero button on the Transport to go to the beginning of the session. The new movie file will include all the video and audio material in the session, even if the duration of the video material is longer than the audio or vice versa. If you only want to bounce a portion of a session, open the Edit window and select the section that you want to include in the bounce.
- 4 Choose Movie > Bounce to QuickTime Movie (Pro Tools 6.1 and higher) or Bounce to Movie (Pro Tools 6.0.x and lower).

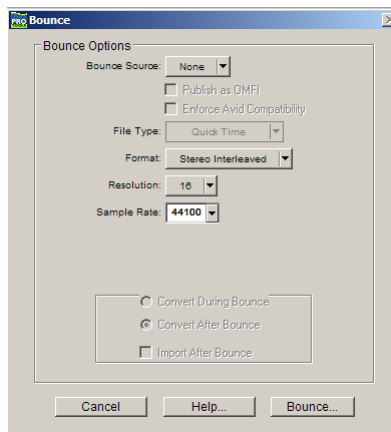

*Bounce dialog*

- 5 Select the file format for the movie audio. Choose Stereo to retain the stereo mix of the session for the movie audio. Choose Mix-to-Mono to combine the left and right channel output of the session to a mono movie soundtrack.

**⚠** *Mix-to-Mono may result in clipping if you do not leave 6 dB of headroom in the mix.*

- 6 Select the resolution for the movie audio. Red Book audio CDs are always 16-bit, while some multimedia presentations and CD-ROMs use 8-bit resolution. You cannot create a QuickTime movie with 24-bit audio; audio from 24-bit sessions is converted to 16-bit or 8-bit audio, depending on what you choose.
- 7 If you intend to convert the session to 8-bit resolution for use in multimedia, use the Squeezer option (click the Convert after Bounce option, then the Settings button to access this feature) to improve the fidelity of the converted 8-bit audio. This option uses a proprietary DSP algorithm that preprocesses the audio using compression, limiting and gating before converting to 8-bit resolution. This option is recommended for optimal results for 8-bit audio.

**8** Select the Sample Rate for the movie audio (click the Convert after Bounce option, then the Settings button to enable this choice). The default audio sample rate is 44100 (44.1 kHz), which is the standard sample rate for audio CDs. Multimedia presentations and CD-ROMs may use a sample rate of 11025 (11.025 kHz) or 22050 (22.050 kHz).

**9** Click Bounce, name the new movie, and choose where to save it.

**10** The audio tracks are converted to the selected sample rate and bit resolution, and a new flattened movie is created incorporating the audio. You can open and play the flattened movie in any software application that supports QuickTime.



*Pro Tools sample rate and bit resolution conversions use large amounts of processing power. You can save time by selecting a lower sample rate conversion quality in the Editing Preferences.*



# Appendix A: DSP-Induced Delays in Mixing (TDM Only)

This appendix provides an overview of DSP-induced delays, and explains how you can compensate for these delays to improve time and phase alignment of audio in complex or critical mixing situations.

- To learn about DSP-induced delays and when you should compensate, see “Introduction to DSP-Induced Delay” on page 589.
- To learn how to use Delay Compensation on supported systems for automatic delay compensation, see “Delay Compensation” on page 590.
- To learn about manual delay compensation, see “Manually Compensating for Delays” on page 591.
- For details on the sources of DSP-induced delay, see “Delay Factors” on page 592.

---

## Introduction to DSP-Induced Delay

In all digital systems, signal processing incurs signal delays of varying amounts. These DSP-induced delays can vary from as short as several microseconds to as long as several milliseconds, depending on the type of processing or routing being performed.



*Do not confuse signal processing-induced delays with time domain effects processing (such as delay, echo, reverb, and other desirable delay effects).*

Each plug-in, hardware insert, and mixer assignment on a track delays that track by an amount equal to the total of all DSP-delay factors. (For details on these delays, see “Delay Factors” on page 592.)

In some cases, signal processing delays matter only if you use a real-time TDM plug-in on one channel of a stereo or multichannel signal but not the others. This imparts an unequal amount of delay to the signals, which causes cancellation of certain frequencies.



*Audible symptoms of phase issues include comb-filtering and loss of high frequencies.*

In simple terms, DSP-induced delay can cause channels to arrive at the main output (or a sub-mix output) at different times. To maintain time alignment, you can *compensate* for DSP-induced delays.

## When to Compensate

You may only really need to compensate for delays between tracks where phase coherency must be maintained (as with instruments recorded with multiple microphones or stereo pairs). If you are working with mono signals, and the accumulated delays are small (just a few samples, for example), you probably needn't worry about delay compensation.

However, larger sessions with higher track and voice counts, many plug-ins, and/or complex mixer routing can benefit when DSP-induced delays are compensated to maintain proper time alignment.

In any session, if you want to maintain absolute time alignment across all tracks you should always compensate for signal processing delays.

## Overview of Delay Compensation Options

Pro Tools provides tools to compensate for signal processing delays including Automatic Delay Compensation (Pro Tools|HD only), as well as several forms of manual delay compensation.

To compensate for offsets incurred by processing delays, do any of the following (as available on your system):

**Pro Tools|HD (6.4 and Higher)** Automatic Delay Compensation lets Pro Tools automatically calculate and compensate for processing delay. See “Delay Compensation” on page 590.

**All Systems** Whenever Automatic Delay Compensation is not available, you can do one or more of the following:

- Apply sample-level delay to tracks with the TimeAdjuster plug-in (see “Using the TimeAdjuster Plug-In” on page 591).
- Manually nudge tracks earlier or later in time as needed “Nudging Audio Tracks” on page 592.
- Use the same plug-ins on all tracks.

While learning about delay compensation, keep in mind that the best results can be often obtained by using a combination of one or more methods. Doing so gives you more options for managing DSP resources as needed by Automatic Delay Compensation and the TimeAdjuster (TDM) plug-in. In addition, the variety of tools available for delay compensation help ensure compatibility if the session is to be transferred to another system.

---

## Delay Compensation

Delay Compensation is used to manage DSP delays that occur on audio tracks, Auxiliary Inputs, or Master Faders because of plug-in use and mixer routing. Pro Tools maintains time-alignment between tracks that have plug-ins with differing DSP delays, tracks with different mixing paths, tracks that are split off and recombined within the mixer, and tracks with hardware inserts.

To maintain time alignment, Pro Tools adds the exact amount of delay to each track necessary to make that particular track's delay equal to the delay of the track that has the *longest* delay.

Delay Compensation should be enabled during mixing and playback for optimal delay compensated sound. In some cases when recording, Delay Compensation should be turned off.

### **To use Delay Compensation to compensate for DSP-induced delays:**

- 1 Choose Setup > Playback Engine, and choose a Delay Compensation setting (see “TimeAdjuster and Delay Compensation” on page 591).
- 2 Choose Display > Mix Window Shows > Delay Compensation View.
- 3 Choose Operations > Use Delay Compensation.
- 4 Use the track Delay Compensation displays and other settings to do any of the following, as needed:
  - Define specific delay values for hardware inserts
  - Bypass Delay Compensation per track
  - Fine tune Delay Compensation for each track by entering a User Offset

## **TimeAdjuster and Delay Compensation**

TimeAdjuster plug-ins behave in a special way when used with Delay Compensation.

- When Delay Compensation is enabled, all other plug-ins (except TimeAdjuster) report their delay to the Delay Manager, and this delay is what is displayed in the Delay Indicator view of each track. The Pro Tools 6.4 (and higher) version of TimeAdjuster, however, does not report its Delay setting to the Delay Manager, preventing a type of “delay compensation” loop from occurring.
- When Delay Compensation is turned off or unavailable, TimeAdjuster operates as expected and applies its Delay to the track for manual delay compensation.

This ability to maintain TimeAdjuster instances and their Delay settings lets you more easily transfer sessions between systems with and without Delay Compensation.

---

## **Manually Compensating for Delays**

If you want to compensate for offsets incurred by processing delays, there are different methods you can use:

- Apply sample-level delay to tracks with the TimeAdjuster plug-in
- Physically adjust tracks in the Edit window by the appropriate number of samples (for example, by using the Nudge function).
- Use the same plug-ins on all tracks.

### **Using the TimeAdjuster Plug-In**

You can use the TimeAdjuster TDM plug-in provided with your Pro Tools system to apply an exact number of samples of delay to the signal path of the tracks you are working with. Up to 2048 samples of delay are available.

Digidesign TDM plug-ins display their delay values in the track Channel Delay Indicators in the Mix window. TimeAdjuster can be used to match these delay values for tracks that need to remain in phase (such as instruments recorded with multiple microphones or stereo pairs).

 See also “TimeAdjuster and Delay Compensation” on page 591.

### **To use TimeAdjuster to compensate for a time delay:**

- 1 In the Mix window, Control-click (Windows) or Command-click (Macintosh) the track’s Volume Indicator to toggle between Volume (“vol”), Peak (“pk”) and Channel Delay (“dly”) indications. Delay values are shown in samples.
- 2 Apply the TimeAdjuster plug-in to a track whose delay you want to increase (to match the the first track).

**3** Control-click (Windows) or Command-click (Macintosh) the track's Volume Indicator until the Channel Delay value is displayed for that track.

**4** Change the delay time in TimeAdjuster by moving the Delay slider or entering a value in the Delay field, until the track delay value matches that of the first track.

You can test the delay values by duplicating an audio track and reversing its phase while compensating for delay.

If you are using a plug-in whose delay factor you are not familiar with, you can set the delay by ear using one of two methods:

- If you are working with phase-coherent track pairs, or tracks that had been multi-miked, you can “null out” the delay. Invert the phase of the target track using the TimeAdjuster Phase Invert button, and adjust the plug-in delay time until the signal disappears. (When they are perfectly synchronized, duplicate signals of opposite polarity cancel each other out.) When you are finished, disengage the Phase Invert button.

– or –

- Change the delay while listening to the signal in phase, adjusting until any comb-filter effects cancel out.

## Nudging Audio Tracks

On audio tracks, you can use the Pro Tools Nudge feature to nudge the affected regions in single-sample (or other) increments, to preserve phase coherency. If it is necessary to nudge a region by a large number of samples, you may want to calculate the equivalent value in milliseconds and nudge the Region in millisecond increments. If the value doesn't divide evenly, you can switch the Nudge value back to samples and use these smaller increments for the remainder.

The disadvantage of using this method is that it only works with audio tracks (not live inputs), and the timing relationship between tracks is permanently altered, which can affect editing.

## Sample Rate and How it Affects Delay

The delay in samples caused by TDM processing is the same regardless of the sample rate because a sample is tied to the rate of the sample clock for the entire system. However, when samples are converted into a time value (milliseconds or microseconds), the sample rate (44.1 versus 48 kHz) must be taken into account.

---

## Delay Factors

In Pro Tools TDM systems, delay is incurred when you perform the following processes:

- Real-time processing (plug-in inserts). See “Using Plug-In Inserts” on page 593.
- Mixing and routing (sends and hardware inserts). See “Using Sends and Hardware Inserts” on page 593.
- Bouncing tracks. See “Bouncing Tracks” on page 594.



## Using Plug-In Inserts

Using plug-in inserts on a track causes additional delay.

 For specific information on the delay amounts for DigiRack or Digidesign plug-ins, refer to your DigiRack Plug-Ins Guide or Digidesign Plug-Ins Guide.

### Channel Delay Indicator

On all systems, the Channel Delay Indicator in the Mix window displays the total delay, in samples, incurred on the track from the use of any TDM plug-in on that channel.

 For information on delay indication when using Delay Compensation (automatic), see “Delay Compensation” on page 428

### To see the amount of processing delay on a track that uses plug-in inserts:

- In the Mix window, Control-click (Windows) or Command-click (Macintosh) the track’s Volume Indicator to toggle between Volume (“vol”), Peak (“pk”) and Channel Delay (“dly”) indications.

## Using Sends and Hardware Inserts

When you send a track to another track and return it to a track (audio, Auxiliary Input, or Master Fader), the following delays are incurred:

### Sends delays for Pro Tools|HD systems

HD Mixer	Sends	Delay
Stereo Mixer	Pre-fader send to bus	10 samples
	Post-fader send to bus	8 samples
Surround Mixer	Pre-fader send to bus	8 samples
	Post-fader send to bus	12 samples

### Sends delays for Pro Tools|24 MIX-series and Pro Tools|24 systems

System	Sends	Delay
Pro Tools MIX-series or Pro Tools 24	Pre-fader send to bus	3 samples
	Post-fader send to bus	6 samples

Using hardware sends also results in delays, as described below.

## Using Hardware I/O

When an audio interface is used on an insert or (send), there is delay introduced by going through the D/A and A/D converter pair (for analog devices) or digital I/O connection (for digital devices) on the audio interface.

On systems that support Delay Compensation (automatic) you can define a delay value for hardware inserts in the I/O Setup dialog. See “H/W Insert Delay Compensation” on page 84.

The tables below list the delay incurred by each type of analog and digital output available in Pro Tools|HD and Pro Tools|24 MIX systems.

**HD-series I/O characteristics**

Interface and I/O Port	Surround Mixer	Stereo Mixer
192 I/O or 192 Digital I/O AES/EBU	24 samples	22 samples
192 I/O Analog	105 samples	103 samples
96 I/O AES/EBU	21 samples	19 samples
96 I/O Analog	79 samples	77 samples

**I/O characteristics for MIX-series audio interfaces connected to HD Legacy Port**

Interface and I/O Port	Surround Mixer	Stereo Mixer
888 24 I/O AES/EBU	18 samples	16 samples
888 24 I/O Analog	82 samples	80 samples
888 20 I/O AES/EBU	20 samples	18 samples
888 20 I/O Analog	18 samples	16 samples
ADAT Bridge Optical	18 samples	16 samples
ADAT Bridge S/PDIF	76 samples	74 samples
1622 I/O Optical	18	16 samples
1622 I/O S/PDIF	76	74 samples

 On the 888|24 I/O, the Digital I/O delay incurred when using AES/EBU or S/PDIF is identical.

**I/O characteristics for MIX-series audio interfaces connected to MIX-series systems**

Interface	A/D/A delay	Digital I/O
888 24 I/O	81 samples	17 samples
882 20 I/O	75 samples	17 samples
1622 I/O	75 samples	17 samples

## Bouncing Tracks

**Bus-based Bounces** When you bus a track to another track and record the result, the following delays are incurred:

**Bus-based bounce delays for each Pro Tools system**

Pro Tools System	Delay
Pro Tools HD-series (Stereo Mixer)	10 samples
Pro Tools HD-series (Surround Mixer)	8 samples
Pro Tools 24 MIX-series	10 samples

**Bounce to Disk** The File > Bounce To Disk command causes no delay on a TDM-equipped system since delay compensation for the bounce function is built in. This form of bouncing may be more desirable than bus-based bouncing. For details, see “Bounce to Disk” on page 482.

# Appendix B: TDM Mixing and DSP Usage

---

## Benefits of TDM II

Digidesign's TDM (or *time division multiplexing*) technology is based on the concept of a single, high-speed data *highway*, or *bus* that transmits data between your Pro Tools CPU, Pro Tools cards, and the DSP chips on the cards.

Pro Tools|24, and Pro Tools|24 MIX-series cards feature Digidesign's original TDM bus design. Pro Tools HD-series cards feature Digidesign's new and enhanced TDM II architecture. The TDM II architecture provides many advantages over the original TDM architecture in terms of its mixing capacity and flexibility.

With both systems, individual channels from sources such as audio tracks, sends, or busses are sent out from Pro Tools audio cards, and combined together or *multiplexed* onto the TDM bus so that all signals can travel simultaneously and can be accessed within a single sample period.

At the receiving end, the audio cards can listen to any connection on the bus, and take whatever data they need.

The TDM bus runs fast enough to accommodate many audio signals at the same time. Each separate audio signal or *stream*, takes up a single *time slot* on this multiplexed bus.

One of most powerful features of the TDM architecture is that a single time slot can be used to "broadcast" data to many destinations simultaneously. With TDM II, not only can it send data to many destinations simultaneously, but it can also send signals both bi-directionally and "privately" between DSP chips, which effectively provides a much greater number of available time slots. This provides a greater potential number of connections for routing, processing and mixing audio signals within Pro Tools.

The examples that follow illustrate how the original TDM I bus and TDM II differ in their handling of data.

## MIX-series card

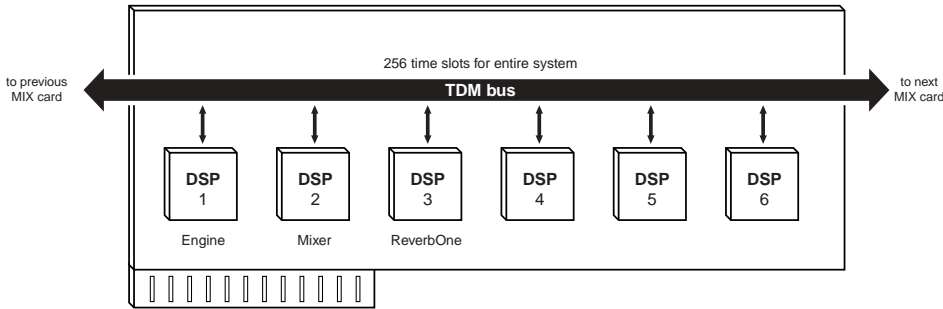
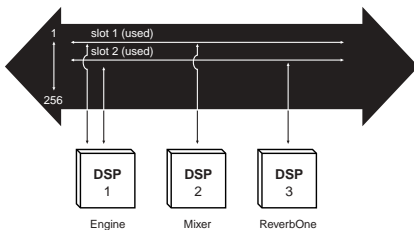

Figure 49. TDM bus on Pro Tools MIX-series hardware

## TDM (or TDM I)

The TDM I architecture has a single bus where every DSP within the entire TDM system shares a single pool of 256 time slots. See Figure 49. In practice, this means, for example, that if an audio track has a Reverb One plug-in insert, one of the 256 time slots is used to connect the Engine DSP on one chip to the Reverb One plug-in DSP on another chip. The TDM time slot used comes from the pool of 256 time slots, and is unavailable for use by the rest of the system.



Time slot usage on Pro Tools MIX-series hardware

## TDM II

With TDM II, there is a separate TDM I/O bus between each DSP chip on the Pro Tools cards, each with up to 512 bi-directional time slots at a session sample rate of 44.1 or 48 kHz (both between DSPs on each card, and between the DSPs

that communicate between cards). The DSP chips are arranged serially, with a TDM I/O bus connecting one chip to the next. This means that every TDM II connection need only use time slots between the two DSPs that are being connected. See Figure 50 on page 597.

So, using the same example as above, if an audio track has a Reverb One plug-in insert, a time slot is used between the Engine DSP (sending out the audio track) and the DSP with the Reverb One instance. If the Reverb One insert is handled by a DSP that is physically next to the DSP handling mixing tasks, as shown in the illustration below, this leaves time slot 2 available for use between DSP 3 through DSP 9, and subsequent HD cards.

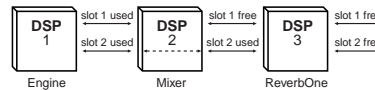

Time slot usage on Pro Tools HD-series hardware

The maximum consumption of the time slots for a single connection occurs when the audio must be sent between the first and last DSP in the system. In this instance, a time slot between each DSP is used to reach the last DSP in the chain.

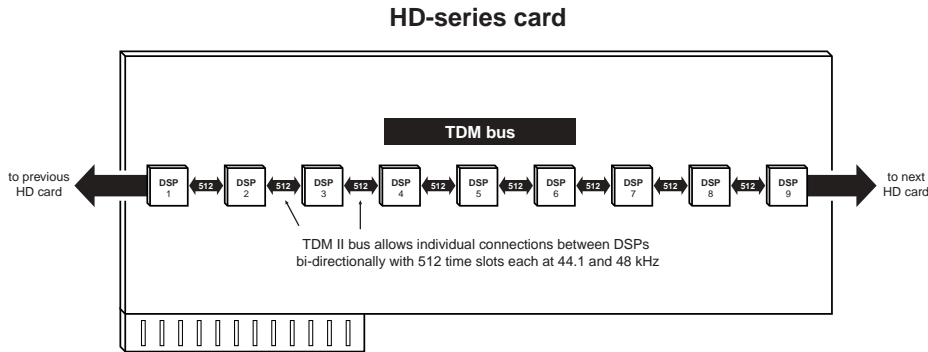

Figure 50. TDM bus on Pro Tools HD-series hardware

Another example of how TDM II is more efficient than TDM I is to imagine a single HD Core card with one Engine chip and two Mixer chips. The DSPs with plug-in instances associated with the first Mixer don't need to communicate with the second Mixer, therefore the time slot numbers used can be re-used by the second Mixer to communicate with other DSPs loaded with other plug-ins.

## DSP Allocation

### (TDM Systems Only)

Digital Signal Processing (or DSP) capability is one of the most powerful elements of your system. The DSP chips in your system provide the real-time processing power for your TDM Mixer and plug-ins. There is a limit, depending on your system, to how many functions a single DSP chip can power at once. This section contains some guidelines for getting the most from your available DSP capacity.

## DSP Allocation Basics

As in the analog world, every send bus or output mix that you use demands that a summing mixer exist for that group. On an analog console, the number of these summing mixers is fixed by the physical layout of the console. In the Pro Tools mix environment, this number is variable, and depends on the number of output mixes or sends that you choose to create. Pro Tools allocates DSP power as it is needed to build the mixers for each session.

We refer to certain mixing or signal processing functions as “using one DSP” or “using two DSPs.” This refers to the fact that there are a certain number of DSP chips on a card, as follows:

### DSP chips on a TDM card

TDM System	Card	Chips
Pro Tools HD-series	HD Core, HD Accel, or HD Process	9
Pro Tools24 MIX-series	MIX Core, or MIX Card	6
Pro Tools 24	DSP Farm	4

Each chip on a card can only power a certain number of processing functions. If you have a single HD card, MIX card or DSP Farm card, and you create a big enough TDM mixer and use enough sends or plug-ins, you will eventually use up or “max out” all DSPs.

### **HD Accel Cards and DSP**

Each HD Accel card includes nine DSP chips:

- ◆ Seven of the chips on HD Accel cards are 220 MHz Motorola DSP chips, which are more than twice as fast as the chips on HD Process cards. These chips are provided in the following two memory configurations:
  - Four of the seven chips are configured with 512k of external SRAM to accommodate long delays and reverbs, even at 88.2 kHz and higher sample rates.
  - The remaining three chips provide 160k of internal memory, capable of supporting a wide variety of plug-ins with more instances than previously available.
- ◆ Two chips are original Pro Tools|HD-series DSP chips. These chips are used for mixers and plug-ins.

### **Mixing and DSP Usage**

Pro Tools builds a TDM mixer every time a session is opened. Note that the term “mixer channel” applies to audio tracks (total voiceable tracks) and Auxiliary Input tracks, as well as sends and returns that use any of the 64 TDM internal busses. When you go beyond a certain number of mixer channels, Pro Tools will use another DSP to create additional mixer capacity.

Master Faders do not use additional DSP power.

With Pro Tools|24 systems, Pro Tools does not always automatically free up all unused DSP power when you delete an unneeded mixer channel. On these systems, to reclaim all DSP power after a change in your session configuration, close your session and reopen it. Pro Tools will rebuild your new mixer configuration to use DSP power with maximum efficiency.

### **DSP Manager (TDM Systems Only)**

Pro Tools software (version 4.3 and higher) includes *DSP Manager*, a software component that optimizes the use of DSP capacity on Pro Tools HD-series and MIX-series systems.

When you have an HD (or MIX) card in your system, if your current DSP usage is approaching the capacity of the card, and you then try to add a mixer channel or assign a plug-in, the DSP Manager will automatically try to make room for the new mixer or plug-in on the HD (or MIX) card. It does this by reallocating the existing TDM mixers and plug-ins to use the available DSP capacity on the HD (or MIX) card as efficiently as possible.

### **Monitoring DSP Usage**

The System Usage window provides a display of DSP usage. As you allocate DSP to mixing or processing with plug-ins, the System Usage window indicates when DSP chips are available and when they are in use. Green indicates a chip is free. Red indicates a chip is in use.

There are three different System Usage view formats: Large, Detailed, and Gas Gauge. The Detailed and Gas Gauge formats show the percentage of each DSP chip in use.

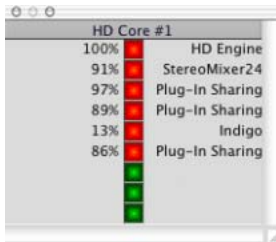

System Usage window showing Detailed format

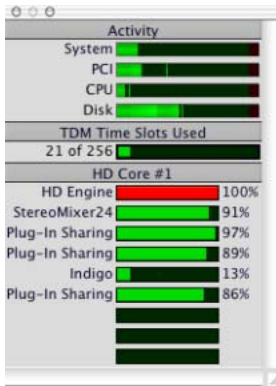

System Usage Window showing Gas Gauge format

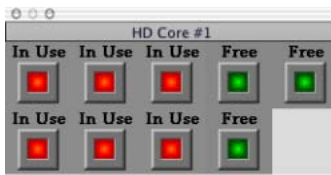

System Usage window showing Large format

With these indicators as your guide, you can try different mixer setups and different arrangements of plug-ins, sends, and Auxiliary Inputs to maximize your use of available DSP power.

💡 Another feature available for DSP management is Active and Inactive switching. See “Active and Inactive Items” on page 17.

**To monitor the usage of DSP resources during a Pro Tools session:**

- Choose Windows > Show System Usage.

**To display DSP resources in different formats:**

- Choose Display > System Usage Window Shows and choose a format from the Display menu.

## Setting up Sessions to use DSP Efficiently

The dynamically configurable mixing environment in Pro Tools lets you make choices based on the type of setup you want to have—such as how many inputs you want for your mixer, how many plug-ins you want to use, or how many sends you need.

For example, you could allocate all of your DSP power to create a large mixer with dozens of channels—but you wouldn’t be able to use as many busses, sends, or TDM plug-ins. Alternatively, you could create a mixer with a smaller number of mixer channels plus some sends and Auxiliary Inputs for returns, and TDM plug-ins on several tracks.

💡 RTAS (Real-Time AudioSuite) plug-ins, as well as AudioSuite plug-ins, do not use DSP and are always available. Refer to your *DigiRack Plug-Ins Guide* for more information.

You can set up your session by choosing one of the session templates supplied with your system as a starting point, or by building it from scratch. If you are starting from scratch, a good rule of thumb is to start by building your mixer first, since at least one of the DSPs in your system is automatically dedicated to mixing. Start

with audio tracks, then add sends and Auxiliary Inputs, and finally add plug-ins as available DSP allows. Master Faders do not use additional DSP power.

---

## DSP Usage with TDM Mixers

### Understanding Mixers

Pro Tools TDM Systems include two mixer plug-in “flavors”: stereo and surround versions. The mixer plug-ins are used by Pro Tools to create “dynamic mixers,” meaning that the mixer size can *expand* or *contract* as mix channels are added or deleted in Pro Tools. More channels take up more DSP power from your Pro Tools HD-series or Pro Tools MIX-series hardware. This is different from hardware mixing consoles where hardware (analog or digital) creates “fixed” mix configurations consisting of an unchangeable number of master outputs, busses or sends.

DSP allocation for mixing in a Pro Tools TDM system is based on the concept of DSP summing mixers. Every send bus or output mix that you use requires that a summing mixer exist for those signals. Every single signal path that is mixed together requires the use of a mixer plug-in (whether a main output that goes to hardware, a bus or a send). This is even true for an individual signal that travels from hard disk to an individual hardware output. These individual dynamic mixers are created using the appropriate TDM mixer plug-in (stereo or surround) that is installed in your Plug-Ins folder.

An “input” can be an audio track, a send, or an internal bus connection. Adding an output or bus path (mono or multi-channel) adds the requirement for DSP power to mix the signals together.

An HD card has nine DSPs, a MIX card has six DSP chips, and a DSP Farm card has four DSP chips, each of which can power a certain number of signal processing tasks. DSP resources are dynamically allocated as the number of mixers and inputs increases.

The TDM mixer provides basic building blocks by which applications such as Pro Tools can create a wide variety of mixer configurations.

### Mono and Stereo

Each TDM mono or stereo mixer is of the dimensions “N x 2,” meaning that it mixes a variable number of inputs to an output pair. For example: a session with six tracks routed to Output 1–2 would require a single 6 x 2 mixer. If one of the tracks is assigned to Output 3–4, however, two mixers are required—one 5x2 mixer routed to Output 1–2, and one 1x2 mixer routed to Output 3–4.

### Multichannel Surround

Each Surround mixer can have a variable number of outputs as well as a variable number of inputs. For example, the 7.1 format requires eight outputs. A single mono track assigned to a 7.1 Output or Bus path would require a 1x8 mixer, while one mono and one stereo track would require a 3x8 mixer.

The important concept here is that every output (whether they are I/O or bus outputs) requires that a mixer exists for that output. This means that creating a send to bus 1 requires that a mixer be created for the bus 1–2 outputs, and that mixer will have one input.



## Mixing with Sends and Busses

Each send will add an input to the destination output pair. For example, a send to output 1 will add another input to the output 1–2 mixer. If the send destination doesn't already have a mixer for its output pair, then a new mixer will be created. A send to bus 3 will make a 1x2 mixer for bus 3 if no other bus 3 sources have been created yet.

In addition, adding a new track and assigning its input to a bus source will create a mixer for that bus pair if there isn't one already. For example, creating a new Auxiliary Input track and setting its input to bus 5 will create a 1x2 mixer for bus 5, even if no sources have been created yet.

## Submixing

When the number of channels that must be mixed exceeds the capacity of a single DSP, additional “main” mixers are created automatically, along with summing submixers (which sum together the “main” mixers). The use of submixers allows large mix configurations to be created.

For example, on a Pro Tools HD-series system, when a Stereo mixer running at 44.1 kHz needs to grow to more than 68 inputs, a submixer is created along with another “main mixer” that provides “n” number of inputs beyond 68. Both the original 68x2 mixer and the new “N x 2” mixer which provides additional inputs are routed to a submixer, and its outputs are finally sent to the desired destination (such as Output 1–2 on your main audio interface).

Note that any small delays (on the order of a few samples) that are created remain equal between these main mixers because they are summed together by means of submixers, and are not cascaded.

The total number of voiceable tracks supported by your particular Pro Tools configuration will ultimately determine the maximum number of channels for your TDM mixer.

## Mixers and DSP Hardware

Different mixer plug-ins are available, each of which uses DSP power at slightly different rates on the different audio cards (and their DSP chips), as shown in the following tables.

 See also “TDM Mixer Plug-Ins” on page 606.

In Pro Tools HD-series systems, additional mixers are available, based on session sample rate.

**HD Accel Card, Standard mixers**

Mixer	Sample Rate (kHz)	Usage
Stereo	44.1 and 48	124x2
	88.2 and 96	54x2
	176.4 and 192	16x2
Surround, 5.1	44.1 and 48	46x6
	88.2 and 96	34x6
	176.4 and 192	8x6
Surround, 7.1	44.1 and 48	34x8
	88.2 and 96	25x8
	176.4 and 192	4x8

**HD Accel Card, Dithered mixers**

Mixer	Sample Rate (kHz)	Usage
Stereo Dithered	44.1 and 48	113x2
	88.2 and 96	54x2
	176.4 and 192	16x2
Surround Dithered, 5.1	44.1 and 48	44x6
	88.2 and 96	27x6
	176.4 and 192	8x6
Surround Dithered, 7.1	44.1 and 48	34x8
	88.2 and 96	20x8
	176.4 and 192	4x8

**HD Card, default Standard mixers**

Mixer	Sample Rate (kHz)	Usage
Stereo	44.1, 48	68x2
	88.2, 96	44x2
	176.4, 192	16x2
Surround, 5.1	44.1, 48	22x6
	88.2, 96	12x6
	176.4, 192	4x6
Surround, 7.1	44.1, 48	16x8
	88.2, 96	8x8
	176.4, 192	2x8

**HD Card, Dithered mixers**

Mixer	Sample Rate (kHz)	Usage
Stereo Dithered	44.1, 48	56x2
	88.2, 96	34x2
	176.4, 192	14x2
Surround Dithered, 5.1	44.1, 48	19x6
	88.2, 96	10x6
	176.4, 192	1x6
Surround Dithered, 7.1	44.1, 48	15x8
	88.2, 96	7x8
	176.4, 192	not supported

### MIX Card

Mixer	Usage
16-bit & 24-bit optimized, mono	59x2 per chip
16-bit & 24-bit optimized, stereo	29x2 per chip
Surround, 5.1	17x6 per chip
Surround, 7.1	12x8 per chip
Usage with other Surround mixer versions varies with the number of channels in each format.	

## I/O

### (Pro Tools MIX-Series and Pro Tools|24 Only)

If the DSP is also being used for I/O processing, then some of the chip's capacity will be devoted to I/O, yielding slightly lower mixer count (these figures represent maximum numbers when I/O is declared in the Hardware Setup dialog):

### DSP Farm with one I/O Declared

Mixer	Usage
16-bit optimized mono	30x2 per chip
16-bit optimized stereo	15x2 per chip
24-bit optimized mono	20x2 per chip
24-bit optimized stereo	10x2 per chip
Note: The Surround mixer cannot run on DSP Farms, or any DSP that has I/O declared.	

### MIX Card with one I/O declared

Mixer	Usage
16-bit & 24-bit optimized, mono	51x2 per chip
16-bit & 24-bit optimized, stereo	25x2 per chip
Note: The Surround mixer cannot run on a MIX card with I/O declared.	

### MIX Card with two I/Os declared

Mixer	Usage
16-bit & 24-bit optimized, mono	43x2 per chip
16-bit & 24-bit optimized, stereo	21x2 per chip
Note: The Surround mixer cannot run on a MIX card with I/O declared.	

## 48-Bit Mixing Precision

The Pro Tools mixer plug-ins use a register area inside of the DSPs on the hardware to hold a full 48-bits of precision when mixing signals together. This allows a fader to be lowered in level without any loss of resolution. (Even if the fader is lowered almost to the bottom, all 24 of the original 24 bits of the signal are preserved.)

## Mixer Headroom

Use of 48-bit precision when mixing allows the mixer to be designed to provide a very large amount of headroom, which allows the faders on the Pro Tools mixer to be placed in the "sweet spot" position without clipping.

Mixer plug-ins provided with Pro Tools HD-series systems provide 48-bit precision with 48 dB of headroom. This means that on the “input” side of the bus (where signals are summed together), signals can never clip (even if channel faders are set to a full +6 dB of gain).

However, the “output” side of the summing mixer (where the signal is sent in the 24-bit world of a digital output or onto the TDM bus) *can* clip. You can use a Master fader (which does not “cost” any DSP) to scale the output level of any mix summing point (a bus or physical output). The master fader's meters will tell you if you are clipping the mix bus, and the fader can be used to safely scale the level to avoid clipping, with no loss of quality.

Pro Tools MIX-series systems are supplied with two mixers, a stereo 24-bit Optimized version and a Surround mixer. These mixers are almost identical to those supplied with Pro Tools HD-series systems, but they provide only 30 dB of headroom (while still maintaining 48 bits of precision). Since Pro Tools MIX-series systems cannot mix as many disk or auxiliary tracks as Pro Tools HD-series systems, less headroom is needed to avoid clipping, and this is generally not a cause for concern.



*If you are mixing larger numbers of signals together, always use a master fader so that you can monitor levels for the bus (using the master fader meter), and to trim the result to avoid clipping. Since Master faders cost no DSP, there is no reason not to use them.*

## **24-Bit Optimized Mixer**

### **(Pro Tools MIX-Series and Pro Tools|24 Only)**

With the 24-bit Optimized Mixer, the Master Fader meters indicate clipping at *both* the input summing stage and the output level stage at all times. With this mixer, you could lower the Master Fader to reduce your output level, but the Master Fader meters could still indicate clipping at the input stage.

In the unlikely event that this occurs—this mixer's 30 dB of headroom will allow many signals to be mixed without any input clipping—simply follow the procedure to trim back your faders, as described in “Trimming Input Summing Levels” on page 605.

## **16-bit Optimized Mixer**

### **(Pro Tools MIX-Series and Pro Tools|24 Only)**

With the 16-bit Optimized Mixer, the Master Fader meters indicate clipping *only* for the output level stage of the mixer. With this mixer, you could lower the Master Fader to reduce your output level, but any clipping at the input stage would not be indicated.

If reducing the output level has no effect on clipping, it could be occurring in one of the following places:

- ◆ At the input summing stage. To prevent clipping at the input stage, trim the input summing levels.
- ◆ At an insert on the Master Fader. If you are using a plug-in on the Master Fader, its meters show the levels on the insert. To prevent clipping at the insert, trim levels on any plug-ins or Hardware inserts on the Master Fader.

## Trimming Input Summing Levels

With many inputs that contain high-level signals, it is possible to clip the input summing stage of a MIX-series mixer plug-in. This could easily happen with the 16-bit Optimized Mixer, but is very much less likely to occur with the 24-bit Optimized Mixer because of its 30 dB of headroom.

To reduce the levels going into the input summing stage of the Mixer plug-in, lower the fader levels of all track faders using the All Mix/Edit group. If you are using mix automation, you will need to use Automation Trim mode or the Trimmer tool to lower the overall volume of all tracks until the levels are low enough to avoid overloading the mixer input. You can see this clearly by using a Master Fader for that mixer sum point, and examining its meter.

Note that clipping the “input” side of a mixer is *not* a concern on Pro Tools HD-series systems. It is virtually *impossible* to clip the input of any HD-series mixer plug-in, because the 48 dB of headroom provided prevents any possibility of overload, even with a maximum number of inputs being fed by full-code signals with fader gains at maximum. While it *is* possible to clip the “output” side of the mixer, you can safely use a Master Fader to trim your mix bus back to avoid clipping (by simply examining the Master Fader meter for clipping, and pulling back the fader until it disappears; make sure that any plug-ins you may have on the Master Fader inserts are not the cause as well). The 48-bit precision of the mixer allows gain adjustment on the Master Fader with no loss of data integrity or audio quality, so there is no need to trim the individual input faders back to avoid clipping.

## Mixer Automatiion

Volume automation on all versions of the mixers is near sample-accurate (as is pan automation on the stereo versions). In addition, DAE provides 24-bit interpolated values between mix breakpoints, which provides near “analog-like” resolution. This process of interpolation means that a smooth “data series” is created between any two breakpoints that you specify in Pro Tools. DAE calculates these smooth transitions on the DSP hardware with 24-bit precision, which provides extremely smooth volume changes. In addition, DAE “de-zippers” any “live input” to the mixer so that fast, real-time fader changes that come in from fader movements (on the Pro Tool user interface or control surfaces), do not cause audible artifacts as the mixer tries to “catch up” to fast changes that it receives.

## Stereo and Surround Dithered Mixers

The Stereo Dithered and Surround Dithered mixer plug-ins provide non-correlated dither in addition to other basic attributes of the mixers described above. Every output summing point (whether to an internal bus or an physical output) is dithered in these mixers. This technique is used to avoid any possibility of audible artifacts caused by truncation of extremely low level data that occurs when signals pass from the 48-bit world of a TDM mixer to the 24-bit world of a TDM bus connection or a hardware output. Any material that is truncated, lies below  $-144$  dBfs (reflecting 24-bit of dynamic range).

There is dissension in the audio community as to whether or not artifacts that fall within this area are actually audible in some way. (The normal dynamic range of human hearing is generally accepted to fall within a range of around 120 dB, from the threshold of audibility to the threshold of pain.)

Digidesign has developed a mixer that provides all of the benefits of the standard mixer plug-ins, but also provide uncorrelated dither on any summed output. This provides a steady dither “noise floor” at extremely low level, which causes any truncation artifacts to be converted into steady white noise. However, the addition of uncorrelated dither requires more DSP horsepower. As a result, the channel instance count from the dithered versions of the mixers is around 15% lower (or more) than the non-dithered standard versions (this varies with sample rate and mixer type).

For this reason, we offer both types of mixer plug-in. You may want to use the standard mixer in most applications because of its greater efficiency (allowing you to mix more channels without running out of DSP power), or the dithered mixer because of its theoretical advantages.

## **A Note About Dithering to 16-Bit and Dither Plug-Ins**

The Dithered mixers provide 24-bit dither at their summing points. When creating a final mix that results to 16-bits (for example, for CD mastering), final dithering should still be handled by plug-ins that provide dither (such as Digidesign’s Dither plug-in or POWr Dither plug-in). To properly dither the final mix result, insert a dither plug-in on the post-fader inserts of a Master fader. Details about dither and proper usage of the dither plug-ins can be found in the *DigiRack Guide*.

## **TDM Mixer Plug-Ins**

### **(TDM Systems Only)**

Pro Tools HD-series systems come with four different mixers: Stereo, Surround, Stereo Dithered, and Surround Dithered. Pro Tools MIX-series systems and Pro Tools|24 TDM systems come with three different Mixer plug-ins: Surround, 24-bit Optimized, and 16-bit Optimized.

In most cases, the Mixer plug-in that was automatically installed with your system is the best one for all around use. The Mixer plug-in that is installed depends on which Pro Tools system you have:

**Pro Tools HD-Series Systems** The Stereo and Surround Mixer plug-ins are installed by default. When you run your Pro Tools Installer, a copy of the Stereo Dithered and Surround Dithered mixers are placed in the folder “Plug-Ins (Unused).”

**Pro Tools MIX-Series Systems** The 24-bit Optimized Mixer and Surround Mixer plug-ins are installed by default. When you run your Pro Tools Installer, a copy of the 16-bit Optimized Mixer is placed in the folder “Plug-Ins (Unused).”

**Pro Tools|24 Systems** The 24-bit Optimized Mixer is installed by default. When you run the Pro Tools Installer, a copy of the 16-bit Optimized Mixer is placed in the folder “Plug-Ins (Unused).”

## Plug-In Features

### Standard Surround and Stereo Mixers

#### (Pro Tools HD-Series Only)

Both the Surround and Stereo Mixer plug-ins provide the following:

- ◆ 24-bit digital output, from an audio interface output or Bounce to Disk. Mix level scaling stores 48-bit results, using a 56-bit accumulator for maximum precision.
- ◆ 48 dB of mix headroom.
- ◆ Output clip indication.
- ◆ Multichannel mixing formats for surround (Surround Mixer only).

### Surround Dithered and Stereo Dithered Mixers

#### (Pro Tools HD-Series Only)

Both the Surround Dithered and Stereo Dithered Mixer plug-ins provide the following:

- The same features as the standard HD Stereo and Surround mixers, with the addition of non-correlated dither to any output or bus send.

### Surround and 24-Bit Optimized Mixer

#### (Pro Tools MIX-Series and Pro Tools|24 Only)

Both the 24-bit Optimized Mixer and the Surround Mixer plug-ins provide the following:

- ◆ Optimized performance for recording and mixing 24-bit audio.
- ◆ 24-bit digital output, from an audio interface output or Bounce to Disk. Mixing level scaling stores 48-bit results, using a 56-bit accumulator for maximum precision.
- ◆ 30 dB of mix headroom.

- ◆ Input and Output clip indication: Master Fader meters simultaneously indicate clipping at both the input summing stage and the output level stage.

- ◆ Multichannel mixing formats for surround (Surround Mixer only).

### 16-bit Optimized Mixer

#### (Pro Tools MIX-Series and Pro Tools|24 Only)

The 16-bit Optimized Mixer provides:

- ◆ Optimized performance for recording and mixing 16-bit audio.
- ◆ 24-bit digital output mix result from an audio interface output, or when bouncing to disk
- ◆ More mixing channels (On TDM systems, 36 x 2 mixing channels can be created per DSP)
- ◆ 18 dB of mix headroom.
- ◆ Output clip indication: Master Fader meters indicate clipping at the input summing stage only.

## Switching TDM Mixer Plug-Ins

### To Switch TDM mixer plug-ins:

- 1 Quit Pro Tools.
- 2 Open the DAE Folder. The DAE folder is installed at the root level of the System Folder.
- 3 Open the “Plug-Ins (Unused)” folder, locate the Mixer plug-in that you want to use, and drag it to the Plug-Ins folder.
- 4 Open the Plug-Ins folder, locate the mixer plug-in version that you no longer want to use, and drag it to the “Plug-Ins (Unused)” folder.
- 5 Launch Pro Tools.

## Mixer Usage Guidelines

The following conditions apply to mixing with Pro Tools TDM systems.

- ◆ One DSP chip is automatically dedicated to mixing in the TDM environment.
- ◆ As you reach the basic mixer limits for a single DSP chip, the system will automatically begin allocating DSP resources from another chip (if available), making it unavailable for plug-ins.
- ◆ Each bus or send connection requires DSP to mix signals. This means that each send or Auxiliary Input that you create will require DSP power to mix the results.
- ◆ On Pro Tools|24 systems, the 16-bit Optimized Mixer can power more channels per DSP chip than the 24-bit Optimized Mixer plug-in. There may be cases where using the 16-bit Optimized mixer will help conserve enough DSP power to allow for additional plug-ins.

On Pro Tools|24 MIX systems, there is no advantage to using the 16-bit Optimized mixer, so you should always use either the Surround mixer, or the 24-bit Optimized mixer.

---

## DSP Usage with TDM Plug-Ins

Some basic guidelines for DSP usage on Pro Tools systems follow:

- ◆ TDM-equipped systems running Pro Tools 4.3 or higher software use DigiDesign's MultiShell technology, that lets any MultiShell compatible plug-in share DSP chips on both HD Core and Process cards (in a Pro Tools HD-series system), or both MIX cards and DSP Farm cards (in a MIX-series system). Up to five types of MultiShell compatible plug-ins can share a single DSP chip.

 Refer to the *DigiRack Plug-Ins Guide* for details on MultiShell plug-ins.

- ◆ Stereo DSP plug-ins generally use up twice as much DSP as mono plug-ins.
- ◆ Master Faders don't require additional DSP. Use them freely to control submix levels, send/bus output levels, and the master output level of your session.

The session templates provided with your system include several useful preconfigured session setups that make efficient use of DSP resources.

If your computer has unused slots, you can always increase your available DSP resources by adding additional HD Accel or HD Process cards (to a Pro Tools HD-series system), or MIX Farm or DSP Farm cards (to a Pro Tools MIX-series system or Pro Tools|24 system).



---

## DSP Usage and I/O Allocation

On TDM-equipped Pro Tools systems with a single audio interface, at least one DSP chip on your HD card (Pro Tools HD-series systems), MIX card (Pro Tools|24 MIX systems) or DSP Farm (Pro Tools|24) is automatically allocated to mixing and input and output tasks. See “Mixing with Sends and Busses” on page 601 for specifics.

Even though this is only a small portion of the DSP power available on the chip, it effectively dedicates the entire chip to mixing tasks, making it unavailable for plug-ins.

If you have an additional audio interface assigned to an HD Accel, HD Process, MIX Farm, or DSP Farm card, Pro Tools will use a DSP chip *on that card* for mixing and I/O tasks as well.

If you are not currently using your additional interface, you can free up DSP and use it for additional plug-ins.

### **To reallocate I/O capacity on an HD Accel, HD Process, MIX Farm, or DSP Farm card:**

- 1 Choose Setups > Playback Engine.
- 2 From the Card pop-up menu, select the HD Accel, HD Process, MIX Farm or DSP Farm whose DSP you want to reallocate.
- 3 From the Interface pop-up, select No Interface.
- 4 Click OK to close this dialog.

When the session reopens, the DSP that was allocated to I/O is available for mixing or plug-ins.



# Appendix C: Troubleshooting

---

## Backing Up Your Work

It is highly recommended that you back up your work on a regular basis, and especially before making changes to your system configuration.

## Back Up Your Session Data

Back up your session and audio data frequently. There are a variety of media that are suited to back up projects of various sizes, from automated tape backup systems to high-capacity optical drives, to desktop CD-R burners.

The best way to back up a session is to use the Save Session Copy In command to save the session file and all of its associated files to a new location.

## Back Up Your System Setup

**Windows** Create a system recovery disk *after* you have finished configuring your system and installing Pro Tools software. This is more useful than a recovery disk for an unconfigured system.

**Macintosh** Back up your System Folder after you install Pro Tools software.

---

## Common Issues

### Pro Tools Won't Launch

#### Problem

When you double-click the Pro Tools application or a Pro Tools session file, Pro Tools doesn't launch, or displays an error message.

#### Possible Solutions

##### All Systems

- ◆ Check to be sure your computer has the required amount of RAM to launch Pro Tools.
- ◆ Try a complete restart. Turn off your audio interfaces, computer peripherals and your computer, and then turn them on again in the proper sequence.
- ◆ If you tried to launch Pro Tools by double-clicking a Pro Tools session file, close any error message, double-click the Pro Tools application, then try to open the session from within Pro Tools (using File > Open Session).
- ◆ (Mac OS 9 Only) Verify that Virtual Memory is turned off. On the Macintosh, open the Memory Control Panel. If Virtual Memory is turned on, turn it off and restart your computer.

- ◆ (Mac OS 9 Only) Make sure the default set of Mac OS System Extensions is enabled, along with the Open Music System, DigiSystem Init, Direct I/O, and DSP Manager Extensions.

- ◆ Reinstall the Pro Tools application, using the Pro Tools Installer CD-ROM.

### **TDM Systems**

- ◆ Verify that Pro Tools cards are installed in the correct slot order in your computer or Expansion Chassis.

- ◆ Turn off your computer and check to be sure your cables are properly and securely connected to the correct Pro Tools cards and to your audio interfaces.

- ◆ Turn off your computer and check all Pro Tools cards installed in your computer to be sure they are properly seated in their PCI slots, and that any TDM FlexCables (Pro Tools HD-series systems) or TDM ribbon cables (Pro Tools MIX-series systems) are connected properly.

- ◆ Use the DigiTest application (installed in the Pro Tools Utilities folder) as a diagnostic tool to verify that your Digidesign cards are operational.

### **Digi 001 Systems**

- ◆ Turn off your computer and check to be sure your cable is properly and securely connected to the Digi 001 PCI card and to the Digi 001 I/O Box.

## **Audio Interface Isn't Recognized**

### **(TDM Systems Only)**

#### **Problem**

When you launch Pro Tools it does not recognize an audio interface, or a connected audio interface is not available.

#### **Possible Solutions**

- ◆ Turn off your computer and check to be sure your cables are properly and securely connected to the correct Pro Tools cards and to your audio interfaces.

- ◆ Verify that your Hardware Setup is correct; check to see that you have selected the correct Interfaces for each I/O card.

- ◆ If you only have one interface, make sure it is connected to the HD Core card (Pro Tools HD-series systems), MIX Core card (Pro Tools MIX-series systems), or d24 card (Pro Tools 24 systems).

- ◆ Make sure Loop Sync, SuperClock or other synchronization connections to your audio interface are correct. Disconnect the clock source from the interface and see if the problem persists.

---

## **Using DigiTest as a Diagnostic Tool**

### **(TDM Systems Only)**

The DigiTest utility performs diagnostic tests on the Pro Tools cards in your system. If DigiTest reports that any of your cards have failed, click the Info button next to that card. Write down the information that appears and report it to your local Digidesign dealer or to Digidesign Technical Support. Refer to your *Getting Started Guide* for specific DigiTest instructions.

---

## Performance Factors

There are several conditions that may adversely affect the performance of Pro Tools. These include:

**Network Connections** Close any network connections unless you are using them for network interchange of audio data.

**Background Applications** Any software utilities that run in the background or generate disk activity, such as virus protection, disk optimization, or file savers, should be turned off or removed.

**Screen Savers** Screen saver software should be completely removed from your computer before running Pro Tools.

**Power Saver Features** Some automatic power saver features, such as those that spin down the system hard drive, can affect Pro Tools performance. These features should be turned off.

**Virtual Memory** (Mac OS 9 Only) Pro Tools will not launch if Virtual Memory is active. Deactivate Virtual Memory and restart your Macintosh.

**CD-ROM Extensions/Control Panels** Some CD-ROM and removable media Extensions and Control Panels have been linked to audio quality problems. Deactivate any performance-enhancing Extension or Control Panels for such media, and restart your computer.

---

## Before You Call Digidesign Technical Support

### Register Your System

As a registered owner of a new Digidesign product under warranty, you are eligible to receive Digidesign Technical Support. Fill out and sign your Registration Form and mail or fax it to the address supplied with the registration materials.

Refer to the registration materials that came with your system for details on warranty coverage and the range of services available.

### Use Digidesign Resources

In addition to the printed and PDF versions of Pro Tools guides, your system includes the following sources of information:

**Read Me Files** These contain late-breaking information and known issues pertaining to Pro Tools software and hardware configurations. Read Me files are installed in the *Release Notes and Documentation* folder when you install Pro Tools.

**Answerbase** This is a database of common problems and DAE errors, and their solutions based on the latest information from Digidesign Technical Support. This database is installed in the Digidesign folder when you install Pro Tools. Answerbase is also available on the Digidesign Web site ([www.digidesign.com](http://www.digidesign.com)).

**Web Site** The Digidesign Web site includes an area for Technical Support, as well as a Digidesign User Conference (DUC) that includes technical discussions. Visit [www.digidesign.com](http://www.digidesign.com) and go to the Support area or the User Conference area: Support > Tech Support > Digidesign User Conference (DUC).

## Gather Important Information

Digidesign wants to help you resolve problems as quickly and efficiently as possible. If you have the following information handy when you contact Technical Support, it will make the diagnosis of your problem easier. Take a few minutes to collect the following basic information:

### System Information

#### Computer

- ◆ Make, model, processor speed
- ◆ Amount of system RAM
- ◆ Operating system (version of Windows or Mac OS)
- ◆ Any Drivers, Extensions, Control Panels, Disk Utilities, or other system-related applications you may have installed.

#### Digidesign Hardware

- ◆ Type of cards, interfaces, or peripherals
- ◆ Where the cards are installed
- ◆ PCI card order in computer or chassis
- ◆ Interfaces connected to each card

#### Hard Drives

- ◆ Make, Model
- ◆ Drive size (GB)
- ◆ Drive speed (RPM)
- ◆ Drive type (SCSI, FireWire, IDE/ATA)
- ◆ Utility used to format the drive
- ◆ Number and size of partitions on the drive

#### Digidesign Software

- ◆ Pro Tools software version
- ◆ (Mac OS 9 Only) DAE and DSI versions
- ◆ Plug-in versions
- ◆ Other Digidesign software

- ◆ Additional plug-ins from Digidesign Development Partners

#### Other Hardware

Refer to the manufacturer's documentation for operational details.

The most common hardware additions include:

- ◆ SCSI host bus adapter (HBA) cards (manufacturer, model, settings)
- ◆ 1394 (FireWire) cards for Windows systems (manufacturer, model)
- ◆ Expansion Chassis (manufacturer, model, bridge chip type)
- ◆ Video Capture cards (manufacturer, model)

To verify that your hardware is qualified for use with your Pro Tools system, refer Digidesign's Web site ([www.digidesign.com.compato](http://www.digidesign.com.compato)), or contact your Digidesign dealer.

#### Other Software

If you are using other audio or video applications, refer to the manufacturer's documentation for operational details.

Make note of any other software that was running when a problem occurred.

## Diagnostic Information

#### DigiTest

If you run DigiTest, be sure to make a note of any error codes or messages it generates.

#### Other Information

Note any DAE errors or other error codes you encounter. Also make a note of the ability to reproduce the problem under different conditions, such as with another session, or after changing settings such as the DAE Preferred Memory Size (Mac OS 9) or the Hardware Buffer Size.

## Glossary

**9-pin (Sony 9-pin; DB-9)** Industry standard for serial machine control of professional video and audio transports, made by Sony and other manufacturers. Refers to the DB-9-style physical external control connector found on 9-pin-compatible devices.

**Absolute Grid mode** An editing mode that constrains movement and alignment of regions to precise increments on a user-defined grid. See also *Relative Grid mode*.

**A/D (analog-to-digital)** Analog-to-digital converters operate at various bit-rate resolutions and sampling rates, converting analog audio signals to digital audio signals.

**ADAT lightpipe** Standard industry term for optical connection of digital audio. Created by Alesis, the lightpipe can simultaneously stream eight channels of digital audio.

**address (time code address)** Specific SMPTE/EBU time code reference or reading, in hours:minutes:seconds:frames.

**AES/EBU (Audio Engineering Society/European Broadcasters' Union)** Industry professional standard for transferring digital audio between professional-quality audio devices. Most AES/EBU connections utilize an XLR-style 3-pin connector to carry two channels of digital audio.

**AIFF (Audio Interchange File Format)** An Apple Computer audio file format.

**AMS (Audio MIDI Setup)** Apple Computer's audio and MIDI operating system, which is part of Mac OS X. For Macintosh users, AMS replaces Opcode Systems' OMS (Open Music System).

**ATR (Audio Tape Recorder)** A tape recorder of any format, including a Digital Audio Tape (DAT) deck.

**audio interface** Among most Pro Tools systems, the audio interface is a separate box that is attached with a special cable to the audio card, or to a USB or FireWire port. An audio interface typically has analog and digital audio inputs and outputs, and may be equipped with level meters, level controls, and other features.

**audio region** A region of an audio file that is defined nondestructively with pointers. See also *region*.

**Audiomedia III** Digidesign's entry-level PCI card for Pro Tools, includes S/PDIF and stereo analog inputs and outputs.

**AudioSuite plug-in** Digidesign's proprietary file-based, non-real-time plug-in format. AudioSuite processing creates a new audio file with the effect permanently applied.

**audition** Listening to, or "monitoring," one or more tracks or audio files. In Pro Tools, you can audition files before you load them into the program. There are also various ways to audition takes from the Audio Regions List, the Takes List pop-up menu, and from DigiBase browsers.

**auto-created region** Automatically created regions are a by product of editing and punch recording over existing regions.

**Automation modes** Function for recording and playing changes in levels, pan controls, and virtually every adjustable parameter (including plug-in parameters) in Pro Tools. There are several different automation modes in which to write automation data in Pro Tools.

**aux** See *Auxiliary Inputs*.

**Auxiliary Inputs** In Pro Tools, these input channels are used for send and bus returns (input only). Sends are used for output routing.

**auxiliary send** See *send*.

**AVoption** PCI cards and software that integrates Avid video technology with Pro Tools.

**AVoption|XL** PCI card, video interface, and software that integrate Avid video technology with Pro Tools.

**.AVI** Movie file format for the Video for Windows component of Microsoft's Media Player, supported by Pro Tools.

**bit depth** One of two main specifications that define digital audio quality (the other is sample rate). Bit-depth defines how precisely a sound's dynamic range is represented. Also called bit-resolution or bit-rate.

**black burst** See *house video reference*.

**BNC** Coaxial cable connectors used for video and synchronizer signals.

**Bounce To Disk** Mixing a segment of audio (or an entire session) internally to disk, without leaving the digital domain. Bit rate, dithering options, and other parameters are provided by Pro Tools for bouncing to disk.

**breakpoint** Step or level on a track's automation playlist.

**Broadcast WAV File (BWF)** A variation of Microsoft's .WAV audio file format that contains additional data on the title, origination, date, and creation time of the audio content not included in the standard .WAV file format. An important feature of BWFs is their support of *time stamping*. Time stamping allows files to be moved from one session to another and easily aligned to their original point in time.

**browser** The location where information contained in the databases is displayed and manipulated. With DigiBase, files can be moved on the volumes and spotted into Pro Tools sessions by drag and drop.

**bus** (noun) An internal routing path.

**bus** (verb) To route one or more signals to one or more destinations (either internal or external).

**clipping, clipping indicator** the LED at the top of each channel meter indicates a level may have run out of headroom, and is approaching clipping.

**clock reference** Common "speed" reference, which various devices can use to establish synchronization during playback and recording.

**Conductor Ruler** A ruler that can show session data. There are three types of conductor rulers, called Tempo, Meter, and Marker rulers.

**continuous controller data** MIDI instructions that affect MIDI note parameters, including volume, panning, velocity, pitch bend, and modulation. Also, the main type of instructions sent by MIDI control surfaces.



**Control|24** Digidesign-dedicated controller for Pro Tools systems. Includes 16 premium microphone preamps, a control room monitoring section, and a line submixer. Ideal front-end for Pro Tools recording, mixing, and editing.

**crossfade** Function for fading out from one region as you fade in to another region. Crossfade duration is user-selectable from within the Edit window. As with fades, portions of audio for which the crossfade function has been applied are stored in the session's Fade Files folder.

**d24** Digidesign's original 24-bit TDM core card, needs a DSP Farm card to create a Pro Tools|24 TDM system.

**D/A (digital-to-analog)** Digital-to-analog converters operate at various bit-rate resolutions and sampling rates, converting digital audio signals to analog audio signals.

**DAE (Digidesign Audio Engine)** Digidesign's real-time operating system that provides the core functionality of hard disk recording, digital signal processing, mix automation, and MIDI required by Pro Tools and other Digidesign products.

**database** Databasing is a convenient way of storing, organizing, searching, and displaying information. A database file is a collection of records that hold data. In this guide, the term "database" refers to a DigiBase database file. Pro Tools creates and stores database files on local volumes as needed.

**DB-9** See *9-pin*.

**Digi 001** Digidesign all-in-one audio interface for Pro Tools LE systems, comprised of a PCI card and I/O box. Includes two mic preamps, S/PDIF I/O, ADAT lightpipe I/O, and eight channels each of analog input and output.

**Digi 002** Digidesign's FireWire-based Pro Tools LE studio with integrated control surface. Includes eight touch-sensitive, motorized faders and 8 motion-sensitive rotary encoders, eight analog inputs and outputs, four mic preamps, eight channels of ADAT optical I/O, two channels of S/PDIF I/O, and 24-bit/96 kHz A/D and D/A converters.

**Digi 002 Rack** Rack version of Digidesign's Digi 002. This FireWire-based Pro Tools LE system includes eight analog inputs and outputs, 4 mic preamps, eight channels of ADAT optical I/O, two channels of S/PDIF I/O, and 24-bit/96 kHz A/D and D/A converters.

**Digidesign Audio Engine** See *DAE*.

**dither** "Noise" added to an audio signal when down-sampling bit rates. Designed to create a smoother transition at lower amplitudes.

**drop frame** Refers to a variance of SMPTE/EBU time code for NTSC color video (29.97 fps) that omits two frames (frames "0" and "1") every minute except for every tenth minute.

**DSP (Digital Signal Processing)** In audio terms, DSP refers to manipulation of digital audio—everything from reverberation to changes in level.

**DSP Farm** PCI card containing DSP chips, the basic building blocks of a Pro Tools|24 TDM system.

**Edit cursor** Flashing line that appears when you click in a track in the Edit window.

**edit decision list (EDL)** List of edits, or events, typically with each event's respective source in and out times, source reel number, and record in and out times.

**Edit insertion point** Location within a track where you click (without dragging); also location at which a region's start, end, or synchronization point will be placed.

**Edit selection** In the Edit window, this is what is highlighted in the playlist (such as a region).

**Event List** See *MIDI Event List*.

**expansion chassis** Expands the capabilities of Pro Tools TDM systems running on Macintosh computers by adding more external PCI slots.

**ExpressPro-Tools** ATTO's hard disk utility for the preparation of hard drives for Pro Tools. For OS X, a new version of this utility, ExpressStripe, must be used.

**fade** A selection in which the volume rises or falls, typically from or to  $-\infty$ . See also *crossfade*.

**FireWire** A high-speed peripheral standard capable of transferring data. FireWire is commonly used for digital audio and video devices, as well as external hard drives and other high-speed peripherals.

**frames per second (fps)** Number of frames that elapse per second, as defined by the four SMPTE/EBU Time Code fps standards. These include:

- 24 fps (for film applications)
- 25 fps (the PAL/SECAM video standard)
- 29.97 fps (the NTSC color video standard) (see also *drop frame*)
- 30 fps (the NTSC black and white video standard)

**general preference** A preference that affects all sessions for the same user. This differs from a global preference, which is the same for all users. See also *user preference*.

**Grid mode** Used to align regions in tracks to the grid or between Grid boundaries. See also *Absolute Grid mode* and *Relative Grid mode*.

**Groove Template** A template derived from an audio selection using Beat Detective. Groove templates contain information on the timing nuances and dynamics of the selected audio performance. Groove templates can then be used to *conform* or impose these performance characteristics on other audio material using Beat Detective, or on other MIDI material using the Groove Quantize command.

**groups** Linked tracks in which an action in one of the tracks is mirrored in all tracks in the group. Groups can be created separately or linked between the Edit and Mix windows.

**HD Accel** PCI card with additional DSP for Pro Tools|HD systems.

**HD Core** PCI core card, which connects to audio interface and contains the DSP, for a Pro Tools|HD TDM system.

**HD Process** PCI card with additional DSP for Pro Tools|HD systems.

**headroom** Amount of remaining gain available for a given signal before the onset of unacceptable clipping.

**house video reference (black burst)** A type of clock reference signal commonly used to synchronize audio or video devices during playback or recording.

**inactive** Items that have been turned off in Pro Tools to free up or conserve DSP. For example, when a track, send, or plug-in is inactive, its name appears in italics and the item is silent.

**indexing** Used by databases to obtain and maintain the data displayed in browsers. Indexing creates and updates a database with the latest metadata information.

**item** In digiBase, each row of data is referred to as an item in the Items List. Items include Volumes, Catalogs, Session files, and Media files, as well as other types of files.

**latency** Time delays inherent in internal processing or generation of audio signals within a computer.

**Legacy I/Os** Older Digidesign audio interfaces (such as 888|24 I/O and 882|20 I/O) that can be connected to Pro Tools|HD audio interfaces (such as 192 I/O and 96 I/O) for additional input and output channels. Legacy interfaces can only be used with 44.1 kHz and 48 kHz sessions.

**lightpipe** See *ADAT Lightpipe*.

**Loop Sync** A dedicated clock signal for synchronizing multiple HD-series interfaces together. Loop Sync uses a Word Clock signal based on sampling rates of either 44.1 kHz or 48 kHz. As sample rates increase in the system, Loop Sync continues to operate at a base rate of 44.1 kHz or 48 kHz, depending upon the higher rate. Loop Sync should be used only to chain multiple HD-series peripherals together.

**machine control** Pro Tools functions to control or be controlled by an external transport, typically a VTR or ATR.

**Marker** Memory Location referenced on a timeline, typically used to store locations to important points in a session. See also *Memory Location*.

**master (device)** “Lead” machine or Pro Tools System in a synchronized machine arrangement. Slaves follow masters. There can only be one master at any given time.

**Master Fader track** Governs the overall output of one or more tracks.

**media file** A file that contains actual audio, video, or graphics data. It also contains a variety of metadata (such as file name and format).

**Memory Location** Pro Tools supports up to 200 Memory Locations, which can include markers, Edit selections, record and play ranges, track settings, and other data. They can be viewed and sorted in the Memory Locations window, from which they can also be accessed.

**metadata** Media files, session files, and other types of files contain their own sets of metadata, which include general types of data such as file name, creation date, and file size. Metadata varies with file type, format, and kind.

**MIDI (Musical Instrument Digital Interface)** A communication protocol designed to allow equipped instruments such as synthesizers to intercommunicate for control and playback purposes. Information transmitted over MIDI includes note-ons, note-offs, key velocity, pitch bend, and other performance data. Connections are made using cables equipped with 5-pin DIN connectors.

**MIDI Event List** Pro Tools window that shows the contents of a MIDI track in a column, for easy editing of individual MIDI events.

**MIDI I/O** Digidesign’s USB-based MIDI interface. Features 10 MIDI inputs and outputs for a total of 160 MIDI channels and supports time-stamping for superior timing accuracy and precision.

**MIDI Machine Control (MMC)** See *machine control*.

**MIDI Time Code** See *MTC*.

**MIX Core** PCI core card, which connects to audio interfaces and contains the DSP for a Pro Tools|24 Mix TDM system.

**MIX Farm** PCI card with additional DSP for Pro Tools|24 MIX systems.

**MP3 (MPEG Layer 3)** An adjustable-quality audio compression format developed by the Fraunhofer Institute.

**MTC (MIDI Time Code)** Non-SMPTE form of time code that is used by some devices (including Pro Tools) to send and receive timing information.

**nondestructive editing** Leaves audio files intact. As you edit audio within Pro Tools, you are only editing the regions, or “pointers,” to audio files that are stored on the hard drive, unless you explicitly choose destructive modes (during recording, or when using AudioSuite processing).

**non-drop frame** Time code that is not in drop-frame format. In North America, the standard format outside of color video production or post production is typically 29.97 fps non-drop frame.

**NTSC** Video standards developed by the National Television Standards Committee. NTSC color video runs at 29.97 frames per second; NTSC black and white video runs at 30 fps. Used primarily in North and South America and Japan.

**Nyquist frequency** The highest audio frequency that can be accurately sampled, equivalent to one-half of the sampling frequency. The Nyquist sampling theorem showed that the sampling rate must be at least twice the highest frequency present in the sample in order to accurately reconstruct the original signal.

**offline (media)** Not connected to or directly accessible by a computer.

**offline (synchronization)** Not under the control of (or controlling) another device for synchronized playback or recording.

**OMS (Open Music System)** A “MIDI operating system” for Mac OS 9, developed by Opcode. It handles the exchange of MIDI data between applications, including timing signals such as MTC. OMS is replaced by AMS (Apple’s Audio MIDI Setup utility) in Mac OS X.

**online (media)** Connected to and directly accessible by a computer.

**online (synchronization)** Controlled by (or controlling) another device for synchronized playback or recording.

**peak indicator** Indicator light designed to warn of the possibility of clipping, which illuminates as a device’s input reaches a preset degree of headroom.

**performance volume** A storage volume that has been designated to record and/or play back media files in a Pro Tools session.

**PFL (pre fade listen)** Sometimes called a “cue,” this is a channel’s level before it is attenuated or boosted by the fader setting. Master faders are PFL in Pro Tools. See also *pre-fader*.

**playlist** A group of regions arranged on an audio or MIDI track.

**positional reference** Common reference that provides location information that various devices can use to establish synchronization during playback and recording. Most commonly, the information is delivered in the form of SMPTE/EBU Time Code.

**post-fader** Output from a track (typically a send) that is governed by the channel’s fader setting.

**post-roll** Adjustable time for playback to continue beyond the current playback or recording of a selection.

**PRE** Digidesign's remote controllable 8-channel microphone preamp. Features eight discrete, matched transistor hybrid mic-preamp circuits and offers a pristine signal path designed specifically for the Pro Tools environment, but can also be utilized as a stand-alone microphone preamp.

**preamp** In recording studio terminology, a circuit designed to boost relatively low signal levels, such as a microphone output, up to standard line levels of -10 dBV or +4 dBu. Digi 002 and Digi 002 Rack are equipped with four microphone preamps. Digi 001 and Mbox are equipped with two microphone preamps. See also *PRE*.

**pre-fader** Output from a track (typically a send) that is independent of the channel's fader setting.

**pre-roll** Adjustable time that precedes the playback or recording of a selection.

**ProControl** Digidesign-dedicated controller that communicates with Pro Tools by means of ethernet. Features include touch-sensitive, motorized faders, and a dedicated effects editing section.

**Pull Up/Pull Down** Refers to the deliberate "miscalibration" of the audio or video sample rate clock (the audio pitch) in order to compensate for a speed change elsewhere in the production chain. The usual situation in which these rates are encountered is when film footage (at 24 fps) is transferred to color NTSC-standard video tape (at 29.97 fps). Video Pull Up/Pull Down is supported in Pro Tools 5.3.1 and higher.

**quantize** To adjust MIDI note locations or durations to the nearest unit or template structure so that a particular rhythmic "feel" is achieved.

**QuickTime** Apple's system extension for control of time-based events, such as digitized video movies and digitized sound.

**RealAudio** Audio compression scheme designed for streaming over the internet.

**record** Element of a database. A database is a collection of records. Each record represents a particular file (such as a media file or session file). The record contains all of the metadata describing that file, but none of the media. Therefore a record is much smaller than the actual file, and much easier to parse for information.

**region** Within Pro Tools, a "pointer" to a particular track selection or file. Regions can be dragged from the Regions List, or a DigiBase browser, to a track.

**Relative Grid mode** An editing mode that constrains movement and alignment of regions to precise increments on a user-defined grid while allowing the region to maintain an offset relative to that grid point. See also *Absolute Grid mode*.

**resolving** The process of synchronizing multiple devices to a common clock reference.

**RTAS (Real-Time Audio Suite) plug-ins** Digidesign's host-based, real-time effects plug-in format.

**sample rate** One of two main specifications that describe digital audio quality (the other is bit rate resolution). Sample rate refers to how frequently incoming audio is sampled per second during conversion from an analog to a digital signal.

**SCSI HBA (Small Computer System Interface and Host Bus Adapter)** Digidesign's conformed terminology for SCSI cards. SCSI is a type of data bus allowing for the high speed transfer of data between a computer and peripheral devices. An HBA is the card that connects the SCSI bus between the computer and peripheral devices such as hard drives.

**send** An adjustable additional track output, which can be routed to an internal bus for effects processing, monitoring, and submixing.

**session file** A work file, much like a word processing document or a graphics program file. A Pro Tools session file contains data describing how media files are to be played and displayed. It also contains metadata about the files on which it depends (audio and MIDI files, and related data such as fades, playlists, and selections). Each separate project worked on should be stored as its own session.

**session template** A Pro Tools session file whose parameters are preset to a user's specific preferred state. Any Pro Tools session may be saved as a template using the Save As command for convenience of setup.

**slave** Device that "follows" the master during synchronization.

**Slave Clock (or Super Clock)** Digidesign's proprietary hi-speed Word Clock that runs at 256x (256 times) the sample rate. It is required by Pro Tools|24 MIX and Pro Tools|24 systems to synchronize audio interfaces to a single, highly-accurate clock from SYNC I/O, USD, or HD audio interface. See also *Legacy I/Os*.

**Sound Designer II (SDII)** Digidesign's high-quality digital audio file format.

**S/PDIF** Semi-professional version of the AES/EBU standard. Stands for "Sony/Philips Digital Interface Format." S/PDIF connections use coaxial (RCA) or Toslink optical in/out connectors. Most S/PDIF connections carry two channels of digital audio at a time.

**Spot** Audio post production process of aligning audio events to visual events. In Pro Tools, Spot mode lets spot regions to particular time code events.

**Standard MIDI File** Universal format that can be read by virtually any software that reads MIDI. Type 0 is a single line sequence, type 1 is multi-track.

**submix** Routing multiple audio sources to an Auxiliary Input for monitor mixes, bus-master control over levels, and shared effects processing.

**subgroup** See *groups*.

**Super Clock (256x)** See *Slave Clock*.

**SYNC I/O** Digidesign's multi-format synchronization peripheral for Pro Tools TDM systems that supports all major industry-standard clock sources and time code formats. SYNC I/O features near sample-accurate lock to time code or bi-phase/tach signals and a 192 kHz capable, high-fidelity, low-jitter Word Clock.

**synchronization** Process of having two or more audio, video, or other devices play and record as one, at the same speed.

**Sysex (System Exclusive)** MIDI data specific to a particular piece of hardware or instrument.

**TDM (Time Division Multiplexing)** A technology that employs a networked bus of DSP chips that supply the processing power for Pro Tools TDM systems.

**TDM plug-in** Digidesign's proprietary real-time, nondestructive plug-in format for Pro Tools TDM systems.

**time code address** See *address*.

**time code generation** Process of creating "fresh" time code.

**Time Scale Timebase rulers** The Main Time Scale is the Timebase Ruler that determines the time format used for Transport functions, and Grid and Nudge values. The Sub Time Scale is the Timebase Ruler that provides additional timing reference.

**Timebase Rulers** Up to five discrete strips measuring different units (samples, feet.frames, minutes:seconds, bars:beats, or time code) displayed across the top of the Edit window.

**Timeline insertion point** Location on the timeline corresponding to the cursor point, and the point from where playback or recording begins.

**Timeline selection** A selection in any Timebase Ruler that determines the playback or record range.

**transfer volume** A storage volume that has been designated as a Transfer Volume in DigiBase Workspace will not be used to record or play media in a Pro Tools session. Volumes that are not supported by Pro Tools for audio playback, (such as network share volumes or CD-ROMs) will be designated as transfer volumes by default.

**Universe window** Provides a visual overview of all tracks in a session, and can be used to quickly navigate to any location in a session.

**USB (Universal Serial Bus)** A high-speed peripheral standard capable of transferring data at up to 12 Mb/sec. USB is used for many audio and video peripheral devices.

**user preference** A user-definable state for a specific Pro Tools parameter or system setup. Mac OS X has the ability to create separate preferences files for each user. For Pro Tools databasing functions, these include browser views, and parameter and search settings. See also *general preference*.

**user-defined region** Explicitly defined regions that are created when recording or importing audio or MIDI; capturing, separating, or consolidating a selection; trimming a whole-file audio region; or renaming an existing region.

**velocity** MIDI data parameter that describes how fast or hard a key is struck and controls the volume of MIDI note playback.

**video reference signal** Clock information contained in all video signals, which can be used as a clock reference.

**voiceable track** Previously known as virtual voicing; total voiceable tracks refers to the maximum number of audio tracks that can share the available voices on your system.

**voices** With a Pro Tools system, refers to the number of channels that can be played back simultaneously.

**VTR (Video Tape Recorder)** A video tape recorder of any format.

**.WAV** Pronounced "wave," this is Microsoft's Audio File Format. Can be read by Pro Tools on both Windows and Macintosh platforms.

**waveform** Means of visually representing a sound. When sound regions are imported into the Pro Tools Edit window, they can be viewed in waveform view.

**whole-file audio regions** Created when recording or importing audio, consolidating existing regions, and when processing with an AudioSuite plug-in.

**Word Clock** Many professional digital audio products—including open-reel multitrack tape recorders, digital mixing consoles, and digital recorders—have Word Clock (1x sample rate) connectors.

Word Clock allows Word Clock-compatible devices to send or receive external clock information that controls the sample rate, which in turn (where applicable) controls the play and record speed.

**zero crossing** Point at which a wave's amplitude crosses the center line of the waveform display. Typically, a good spot to edit a sound file is at zero crossings, to avoid unwanted artifacts.

**Zoom** Function used to view waveform displays within the Edit window with greater detail or more data.



# Index

## Symbols

.1 (in surround mixing) 502

## Numerics

1622 I/O 6  
16-bit  
    Bounce to Disk 489  
16-bit Optimized Mixer 604  
    plug-in features 607  
176.4 kHz  
    and pull factors 562  
192 Digital I/O 6  
192 I/O 6  
    Hardware Setup 43  
    Soft Limit 43  
192 kHz  
    and pull factors 562  
1x 624  
24 FPS 544  
24-bit  
    Bounce to Disk 489  
    TDM processing 430  
24-bit ADAT Bridge I/O 6  
24-Bit Optimized Mixer 604  
    plug-in capabilities 607  
25 FPS (EBU) 544  
256x 622  
29.97 FPS Drop 543  
29.97 FPS Non-Drop 543, 574  
3 Second  
    Clip Indication 89  
    Peak Hold 89  
3 Second Peak Hold preference 56  
3:2 Pulldown 544  
30 FPS Drop 543  
30 FPS Non-Drop 543  
32-bit, floating 430  
3-knob panning 532  
5.0 paths in 5.1 mixes 521  
5.1 formats in Pro Tools 511  
882 I/O 6  
882|20 I/O 6  
888 I/O 6  
888|24 I/O 6  
8-bit 489

96 I/O 6  
    Hardware Setup 43  
96i I/O 6  
    Hardware Setup 43

## A

AAF format 123  
Absolute Grid mode 225, 276  
active  
    items 17  
    making inserts 436  
    making plug-ins 18  
    tracks 102  
ADAT Bridge I/O 6  
Add Unique Triggers 352  
adding  
    a new playlist 218  
    audio tracks 157  
    Auxiliary Input tracks 406  
    Master Fader tracks 407  
    MIDI tracks 180  
    sends 414  
AES/EBU  
    Hardware Setup 42  
AIFF file format 484  
All Notes Off command 372  
all tracks  
    hiding 94  
    selecting 253  
    selecting all regions in 247  
    selecting in Timebase Rulers 253  
    showing 94  
allocating  
    DSP 597, 599  
    I/O capacity 609  
Amount of memory to reserve for automation recording option  
    62  
Analog In 42  
Analog Out 42  
archiving  
    preparing with Compact Selected 310  
Assignment View  
    sends 416  
Audio During Fast Forward/Rewind option 57, 238

- audio files
  - compacting 311
  - concepts 12
  - default names 144
  - formats 484
  - importing 109
  - mixed file types 50
  - mixed formats 110
- audio format, for session 552
- audio interfaces 8
  - input channels 14
- Audio Media options 116
- Audio Pull Up and Pull Down 559
- audio recording
  - undoing a take 160
- audio regions 212
  - and automation 214
  - fitting to an Edit selection 294
  - stripping silence from 307
  - whole-file 208
- Audio Regions Focus 30, 223
- Audio Regions List 220
  - displaying file info for audio regions 221
  - dragging from 264
  - finding regions 222
  - sorting 221
- Audio Regions List menu 571
  - Auto Rename Selected command 312
  - Clear Selected command 313
  - Compact Selected command 310
  - Display All command 222
  - Export Region Definitions command 123
  - Export Selected As Files command 121
  - Find command 222
  - Rename Selected command 311
  - Selected Unused command 313
  - Show Disk Names option 221
  - Show File Names option 221
  - Show Full Pathnames option 221
  - Sorting option 221
  - Time Stamp Selected command 274
- audio tracks
  - 5.1 format 507
  - adding 91, 157
  - and Output format 515
  - and surround sessions 514
  - and tempo changes 317
  - bouncing to disk 482
  - channel strips 86
  - configuring for recording 157
  - creating 91
  - creating a tempo map for 318
  - loop recording 165
  - placing audio in multichannel tracks 514
  - punch recording 163
  - recording multiple 161
  - signal flow 404
  - Waveform view 209, 212
- AudioSuite
  - Dither 431
  - Duplicate plug-in 287
  - plug-ins 431
  - processing 286
- AudioSuite Buffer Size preference 63
- AudioSuite Dither preferences 63
- audition path 82
- auditioning
  - fades 297
  - pre/post-roll 255
  - programs 369
  - selection start and end points 255
  - takes 166
- Auto button 440
- Auto Input Monitoring option 140
- Auto Match Pull Factors 559
- Auto Regions Fade In/Out Length option 59, 305
- Auto Rename Selected command 312
- auto-created regions 208
  - hiding 312
  - renaming 311
- auto-fades 305
- AutoMatch Indicators 457
- AutoMatch Time option 62, 456
- Automatically Copy Files on Import option 58
- Automatically Find and Relink 130
- automating
  - plug-ins 461
  - sends 460
  - switched controls 460
  - tracks 459
- automation 451
  - and audio regions 214
  - and Duplicate Selected Tracks 453
  - and multichannel pan 535
  - and multiple output assignments 516
  - breakpoints 468
  - buffer size 457
  - capture & apply 477
  - creating 462
  - cutting, copying, and pasting 281, 471
  - deleting 464
  - delta 454
  - drawing with Pencil 465
  - editing 467
  - editing with Smart Tool 289
  - enabling, suspending 463
  - for grouped tracks 470
  - for hidden tracks 94
  - on multichannel tracks 469
  - On Stop 474
  - pass-through point 454
  - playlists 217, 452, 458
  - plug-in accuracy in bounce 490
  - relative and absolute 454
  - rule and Track View 280
  - Safe button 441
  - safing 458
  - smoothing 456
  - snapshot 475
  - special Paste mode 472
  - stepped 468
  - thinning 456, 465
  - To Current or All Enabled 477
  - to start, end, or all 473
  - Trim mode 454
  - trimming 475
  - writing 459
- Automation Enable window 459, 463
- Automation Mode Selector 453

- automation modes
    - Auto Latch 454
    - Auto Off 453
    - Auto Read 453
    - Auto Touch 454
    - Auto Write 453
    - Trim/Auto Latch 455
    - Trim/Auto Off 454
    - Trim/Auto Read 454
    - Trim/Auto Touch 455
    - Trim/Auto Write 455
  - Automation Preferences 61
    - AutoMatch Time option 62, 456
    - Memory for Automation Recording option 457
    - Mutes Follow Mix Groups option 100
    - Smooth and Thin Data After Pass option 465
    - Solos Follow Mix Groups option 100
    - Touch Timeout option 62
  - Automation Safe button 441
  - Automation Write Safe button 444
  - Auto-Name Memory Locations While Playing option 60, 327
  - Auto-Name Separated Regions option 60, 262
  - auto-naming
    - and Strip Silence 308
    - audio files and regions 144
    - playlists 218
    - QuickPunch regions 194
    - separated regions 262
    - takes 144
  - AutoSave option 59
  - Auto-Spot Regions command 569
  - Auxiliary Inputs 424
    - adding 406
    - and DSP usage 608
    - signal flow 405
  - Auxiliary Send level, and Master Fader 427
  - Avid Xpress DV
    - codec requirements for export 579
    - playback in Pro Tools 579
- B**
- bank select 20, 366
  - Bar|Beat Markers
    - and tempo events 320
    - audio with varying tempos 319
    - editing 320
    - from Identify Beat command 318
    - generated with Beat Detective 341
    - moving 320
  - Bars:Beats Time Scale 233
  - bass
    - extension 506
    - management 503, 506
    - redirection 506
    - sub content 503
  - Batch Fades dialog 306
  - Beat Detective 333
    - beat triggers 339
      - deleting 339
      - generating 338
      - inserting 340
      - moving 340
      - promoting 340
    - Collection Mode 349
    - conforming regions 346
    - defining the selection 336
    - detecting transients 338
    - DigiGroove Templates 342
    - edit smoothing 348
    - extrapolation 344
    - generating Bar|Beat Markers 341
    - Groove Templates
      - extracting 343
    - Scroll Next 341
    - separating regions 344
    - system requirements 334
    - Trigger Pad 344
      - with multiple tracks 345
  - Beat Detective Templates 342
  - Beat Detective window 335
  - beat triggers
    - deleting 339
    - editing 339
    - generating 338
    - inserting 340
    - moving 339
    - promoting 340
  - Bi-Phase/Tach 542
  - bit depth, for session 46, 552
  - black burst 573
  - Blocks view 209
  - Bounce to Disk 479, 482
    - and dither 480
    - and time stamps 482
    - Bounce Options 483
    - Convert After Bounce 490
    - Convert During Bounce 490
    - File Type 484
    - Format 488
    - format 484
    - Help button 491
    - Resolution 489
    - sample rate 489
    - sample rate conversion options 489
    - sample rate conversion quality 490
    - source path 483
    - Use Squeezer option 490
  - Bounce to Movie command 586
  - Bounce to QuickTime Movie command 586
  - bouncing
    - to a stereo mix 492
    - to a submix 491
    - to QuickTime movies 586
  - breakpoints 468
    - Avid keyframes 467
  - Browser
    - defined 616
  - Buffer Size
    - Hardware 143
  - bussing
    - multichannel sends 517
    - surround examples 521
  - BWF (.WAV) file format 484
  - Bypass Button
    - for real-time plug-ins 440
- C**
- calculator entry mode (for numeric entry) 252
  - Calibration Mode command 138
  - Calibration Reference Level preference 59

- cancelling record takes 160, 183
- Capture Region command 261
- capturing time code 568
- Center % (Percentage) 533
- Center % in Output window 535
- centered crossfade 296
- Change Duration command 378
- Change Meter command 321
- Change Tempo command 315, 316
- Change Velocity command 376
- Channel Delay Indicator 88
- channel mapping
  - default path order 84
  - editing 76
  - re-mapping 76
- Channel Selector 441
  - for multi-mono plug-ins 518
- channel strips 14
  - audio tracks 86
  - MIDI tracks 87
- channels inputs 14
- chasing
  - controller events 370
  - MIDI notes 370
  - program changes 370
- Cinema Stereo 498
- Classic Numeric Keypad Mode 31, 58
- Clear command 281
- Clear Selected command (regions) 313
- click 27
  - configuring 151
  - enabling 152
- Click Options command 151
  - Click/Countoff Options dialog 151
- Click plug-in 151
- clicks and pops, avoiding 213
- Clip Indication
  - 3 Second 89
  - None 89
- Clip Indication option 56
- clipping 138
  - and 16-bit Optimized Mixer 604
  - and 24-bit Optimized Mixer 604
  - input sum levels 605
- clock source 448
- Clock Source pop-up menu 42
- Close Session command 53
- closing multiple plug-In windows 442
- Collection Mode, Beat Detective 349
- color coding tracks 103
- comb-filtering 589
- Commands Focus 30
- comments
  - entering for tracks 92
- Comments View 90, 409
- Compact Selected command 310
- Compare button 440
- compatibility
  - and automatic delay compensation 590
  - surround formats 504
- compatibility information 4
- Compatibility Preferences 64
- Compress/Expand Edit To Play command 293
  - and multichannel tracks 294
- compressed QuickTime file formats 584
- Conductor button 28
- Conductor Rulers 232
  - including in selections 253
- configuring
  - click options 151
  - MMC 564
  - Pro Tools 37
  - SMPTE 556
- conforming QuickTime movies 583
- connecting
  - effects units 447
  - external audio devices 447
- Consolidate Selection command 310
- continuous controller events 20
- Continuous Scroll During Playback option 241
  - and half-screen 242
- Continuous Scroll with Playhead option 241
  - and half-screen 242
- continuous zoom 226
- control surfaces
  - ProControl 432
- Control|24 432
- controller events 20, 364
  - and MIDI regions 217
  - chasing 370
  - editing 365
  - editing with Smart Tool 289
  - inserting 365
- Conversion Quality option 60, 111, 490, 584
  - Tweak Head setting 490
- Convert .WAV files to AES31/BroadcastWave option 57, 64
- Convert Plug-In pop-up 441
- Convert WAV files to AES31/BroadcastWave 131
- converting session
  - audio file format 49
  - bit depth 49
  - sample rate 49
- Copy command 281
- Copy Edit Selection to Timeline command 258
- Copy Timeline Selection to Edit command 258
- Copy To Send command 423, 461
  - Copy To Send dialog 423, 461
- copying
  - all automation playlists for a track 281
  - MIDI notes with the Split command 375
  - selections and regions 282
  - track automation to sends 461
  - track control settings to sends 423
- countoff 28, 152
- CPU Processing Activity 457
- CPU Usage Limit 38
- Create Fades command 302, 303
- creating
  - crossfades 302
  - fade-ins/outs 303
  - groups 105
  - Mac and PC compatible sessions 131
  - Markers and Memory Locations 326
  - regions 261
  - sessions 45
  - tracks 91
- Crossfade Preference for Pre/Post-Roll option 60, 301
- crossfades 295
  - and dither 431
  - creating with Smart Tool 288

- equal gain 299
- equal power 299, 301
- Fades dialog 297
- in batches 305
- linear 301
- overlap 301
- pre/post 303
- removing 302
- trimming 302
- types 295
  - with dither 299
- current Cursor Location 24
- current meter 28, 321
- current tempo 28, 315
- Current Time display 553
- cursor display 24
- Cursor Location display 24
  - 25
- custom session templates 51
- Custom Shuttle Lock Speed 244
- Cut command 281
- cutting
  - automation 471
  - MIDI notes with the Split command 375
  - selections and regions 282

## D

- DAE 11
- DAE Playback Buffer Size 40
- DAT recorder, recording from 173
- database
  - defined 617
- default
  - audition path 82
  - I/O Setup 80
  - meter 153
  - output path 84
  - path order 84
  - paths 73
  - program change 366
  - sample rate 39
  - tempo 153, 318
  - Zoom Toggle Track Height 230
- Default Fade Settings 60
- Default Note On Velocity option 64, 358
- Default Path Order Selector 84
- Default Settings preference, for TC/E plug-in 63
- Default Thru Instrument 177
- Default Thru Instrument option 65
- Degree of Thinning option 62
- delay
  - Channel Delay Indicator 88
  - MIDI Track Offset 371
- Delay After Play Command preference 65
- Delay Compensation 590
  - and TimeAdjuster 591
  - suggest uses 590
- Delay plug-ins 433
- Delete Fades command 302
- Delete Group command 105
- Delete Path 75
- Delete Selected Tracks command 93
- deleting
  - automation 464, 471
  - existing I/O paths 75

- groups 106
  - in MIDI Event List 399
- Memory Locations 329
- MIDI notes 363
- playlists 219
- program changes 368
- sysex events 370
- tracks 93
- unused regions 313
- delta
  - trimming automation 454
- destructive editing
  - compacting audio files 310
- Destructive Record mode 149, 162
- destructive recording 162
- Digi 001 9
  - modes and I/O Setup 75
  - punching with footswitch 191
- Digi 002 9
- Digi 002 Rack 9
- Digidesign Audio Engine 11
- DigiGroove Templates 342
- digital clipping 138
- Digital Format 42
- digital mastering 493
- digital signal processing (see DSP)
- DigiTest 612
- Direct I/O 612
- Direct Outputs mode 82
- discrete signal control 515
- Disk Allocation 145
  - and cross-platform sessions 146
  - and system volume 147
  - dialog 145
- Display All command 222
- Display Auto-Created Regions option 312
- Display menu
  - Bars:Beats Time Scale 233
  - Display Auto-Created Regions option 312
  - Display Name In Regions option 212
  - Display Time In Regions option 212
  - Edit Window Shows option 21
  - Feet:Frames Time Scale 234
  - Minutes:Seconds Time Scale 233
  - Mix Window Shows option 21
  - Narrow Mix Window option 102
  - Ruler View Shows option 233
  - Samples Time Scale 234
  - System Usage Window Shows 599
  - Time Code Time Scale 234
- Display Name In Regions option 212
- Display Preferences 54
  - Draw Grids in Edit Window option 226
  - Draw Waveforms Rectified option 213
  - Edit Window Color Coding option 103
  - Show Meters in Sends View option 417
- Display Time In Regions option 212
- displaying
  - all regions 222
  - all Rulers 233
  - file info for audio regions 221
  - Meter Ruler 321
  - Original Time Stamps 570
  - region names 212
  - region times 212

- Tempo Ruler 315
- User Time Stamps 571
- dither
  - and Bounce to Disk 480
  - and fades 299, 431
  - AudioSuite 431
  - on Master Faders 480
  - preferences 431
  - resolution and Bounce to Disk 489
- Dither Plug-In preference 63
- divergence
  - and width 503
  - drawing 534
  - using 533
- Dolby Digital 502
- Dolby Surround 498
- Dolby Surround EX 498
- Draw Grids in Edit Window option 55, 226
- Draw Waveforms Rectified option 55, 213
- drum machine style loop recording 185
- DSP 597
  - active and inactive items 17
  - allocating 597, 599
  - and Auxiliary Inputs 608
  - and I/O capacity 609
  - and inactive outputs 413
  - and inactive sends 418
  - and Master Faders 608
  - and mixing 598
  - and no output 413
  - and overall resources 16
  - and Send meters 417
  - and TDM plug-Ins 608
  - I/O and Mixer plug-ins 603
  - monitoring usage 599
  - reclaiming DSP capacity 598
- DSP delays 589
  - automatic compensation 590
  - compensating for 591
- DSP Manager 598
- DTS 498, 502
- dubber
  - preference to emulate 57, 197
- Duplicate command 283
- Duplicate plug-in 287
- Duplicate Selected Tracks
  - for automation 453
- Duplicate Selected Tracks command 93
- duplicating
  - inserts 439
  - MIDI note selections 284
  - playlists 218
  - selections and regions 284
- durations, for MIDI notes
  - editing with Change Duration command 378
  - making more legato 379
  - making more staccato 378
  - randomizing 378
- DV
  - and sync offset 580
- DV Movies
  - playback through Firewire 579
- DV Stream 579
- Dynamics plug-ins 433

## E

- Edit and Timeline selections, unlinked 245
- Edit commands 280
  - and Edit mode 281
  - clear 281
  - cut 281
  - paste 282
- edit commands
  - clear 281
- edit cursor 237
  - and scrubbing 242
  - moving to region boundaries 253
- Edit Dither Settings preference, for Dither plug-in 63
- Edit Group 105
- Edit Groups
  - and selections 246
- Edit Insertion Follows Scrub/Shuttle option 56, 242
- Edit insertion point
  - placing regions at 265
  - trimming regions to 270
- Edit Markers 246
  - and selection length 250
- Edit menu
  - Capture Region command 261
  - Clear command 281
  - Compress/Expand Edit To Play command 293
  - Consolidate Selection command 310
  - Copy command 281
  - Copy To Send command 423, 461
  - Create Fades command 302, 303
  - Cut command 281
  - Delete Fades command 302
  - Duplicate command 283
  - Fade To End command 304
  - Fade To Start command 304
  - Fades command 297
  - Heal Separation command 264
  - Identify Beat command 318
  - Identify Sync Point command 265, 572
  - Insert Silence command 309
  - Lock/Unlock Regions command 279
  - Merge Paste command 285
  - Mute/Unmute Region command 280
  - Paste command 282
  - Quantize Regions command 279
  - Redo command 219
  - Remove Sync Point command 265
  - Repeat command 284
  - Repeat Paste To Fill Selection command 293
  - Select All command 247
  - Separate Region command 262
  - Shift command 278
  - Strip Silence command 307
  - Thin Automation command 465
  - Trim Automation command 478
  - Trim End To Insertion command 271
  - Trim Start To Insertion command 270
  - Trim To Selection command 263
  - Undo command 219
  - Write Automation command 476, 477
- Edit mode buttons 224
- Edit modes 224
  - and edit commands 281
  - and placing regions 264
  - Shuffle 224

- Slip 224
  - Spot 224, 567
  - edit playlists 217
  - Edit selections
    - auditioning with Playhead enabled 258
    - copied from Timeline selection 258
    - copied to Timeline selection 258
    - sliding in the Ruler 254
  - edit smoothing, with Beat Detective 348
  - Edit tools 24
    - Grabber 248
    - Pencil 287
    - Scrubber 242
    - Selector 237
    - Trimmer 267
    - Zoomer 226
  - Edit window 21
    - half-screen 242
    - Pro Tools 6.0 23
    - scrolling from the Ruler 239
  - Edit Window Color Coding option 56, 103
  - Edit Window Default Length option 55
  - Edit Window Follows Bank Selection option 54
  - Edit Window Shows option 21
  - editing
    - across multiple tracks 283
    - and Edit modes 224
    - and Grid modes 276
    - and hidden tracks 94
    - and Track View 280
    - automation 467
    - Bar|Beat Markers 320
    - beat triggers 339
    - breakpoints 468
    - controller events 365
    - during playback 207
    - Grid mode 225
    - in MIDI Event List 398
    - Markers 328
    - Memory Locations 328
    - meter events 322
    - MIDI notes 359
    - MIDI regions 216
    - nondestructive 207
    - nondestructively for audio 214
    - nondestructively for MIDI 217
    - note attributes 363
    - note durations 378
    - note velocities 361, 376
    - program changes 368
    - regions as grid 225
    - Shuffle mode 224
    - Slip mode 224
    - Spot mode 224
    - tempo events 316
    - waveforms 213
  - Editing Preferences
    - Auto-Name Memory Locations While Playing option 327
    - Auto-Name Separated Regions option 262
    - Conversion Quality option 111
    - Crossfade Preference for Pre/Post-Roll option 60, 301
    - QuickPunch Crossfade Length option 191, 196
    - Region List Selection Follows Track Selection option 221, 247
    - Separate Region Operates On All Related Takes option 167, 262
    - Take Region Lengths That Match option 167
    - Take Region Names That Match Track Names option 167
    - Track Selection Follows Regions List Selection option 247
  - effects, printing to disk 479
  - Enable Automation Parameters button 440
  - Enable Session File Auto Backup option 59
  - enabling
    - automation 463
    - AutoSave option 59
    - groups 107
    - MIDI input devices 176
    - plug-in automation 444
  - encoding and decoding 505
  - Enforce Mac/PC Compatibility option 50, 131
  - EQ plug-ins 433
  - equal gain crossfades 299
  - equal power crossfades 299, 301
  - Event Edit Area 24
    - note attributes 363
  - Exit command (Windows) 53
  - Expanded Track Display 211, 469
  - Export MIDI command 126
  - Export Region Definitions command 123
  - Export Selected As Files command 121
  - Export Selected dialog 122
  - Export Session As Text command 123
  - Export Settings button 81
  - exporting
    - a session as text 123
    - AAF files 123
    - audio 121
    - audio from regions 121
    - MIDI tracks 126
    - OMFI files 123
    - region definitions 122, 571
    - stereo interleaved files 122
  - Ext. Clock Output 42, 550
  - extending selections 251
    - to adjacent tracks 252, 253
    - to include adjacent regions 251
    - to Markers and Memory Locations 251
    - to region boundaries 251
  - Extensions 613
  - external clock source 448
  - extrapolation 344
- ## F
- factory I/O settings 82
  - Fade To End command 304
  - Fade To Start command 304
  - fade-in shapes 300
  - fade-out shapes 298
  - Faders Move During Playback option 61
  - fades 303
    - and dither options 431
    - auto-fades 305
    - creating 303
    - creating with Smart Tool 288
    - in batches 305
    - regenerating 130
    - with dither 299

- Fades command 297
- Fades dialog 297
  - In Shape 300
  - Link option 299
  - Out Shape 298
  - Use Dither option 299
- Fast Forward
  - incrementally 238
  - locating with 238
- Fast Forward button 26
- Feet.Frames and QuickTime offset 582
- Feet.Frames Time Scale 234
- file formats (audio) 484
  - AIFF 484
  - BWF (.WAV) 484
  - MP3 486
  - QuickTime 484
  - RealAudio 485
  - SND resource 484
  - Sound Designer II 484
- File menu
  - Bounce To Disk command 482
  - Close Session command 53
  - Delete Selected Tracks command 93
  - Duplicate Selected Tracks command 93
  - Exit command (Windows) 53
  - Export MIDI command 126
  - Export Session As Text command 123
  - Group Selected Tracks command 105
  - Import Audio to Track command 111
  - Import MIDI to Track command 125
  - Make Selected Tracks Inactive command 102
  - New Session command 45
  - New Track command 157, 180
  - Open Session command 47
  - Quit command (Macintosh) 53
  - Revert to Saved command 48
  - Save Session As command 48
  - Save Session command 48
  - Save Session Copy In command 51, 132
  - Split Selected Tracks Into Mono command 286
- files
  - Transfer 130
- Film 498
- film speed 545
- filtering in bass management 506
- final mixdown 492
- Find command 222
- Find Matching Tracks option 118
- finding regions 222
- Firewire
  - QuickTime DV playback 579
- Flatten Performance command
  - Flatten Performance window 391
- Flatten Performance window 391
- formats
  - supported multichannel 498
- frame rate
  - pull up and pull down 559
- freewheeling time code 555
- Front Divergence 533
- Front/Rear Divergence 533

**G**

- generating time code 555, 563

- Global MIDI Playback Offset option 64, 371
- Go to End button 26
- Grabber tool 248
  - editing breakpoints with 467
  - Object Grabber 248
  - selecting MIDI notes with 359
  - Separation Grabber 263
- Grid
  - setting for MIDI editing 357
  - value selector 225
- Grid mode 225, 276
  - Absolute 225, 276
  - configuring 225
  - Draw Grids in Edit Window option 226
  - enabling 225
  - Regions/Markers option 225
  - Relative 225, 276
  - setting the Grid value 275
  - suspending 276
- grid panners in Mix and Edit 525
- Grid value 275
- Groove Quantize command 385
  - Groove Quantize window 385
- Groove Quantize window 385
- Groove Templates 342, 343, 386
- groove templates
  - applying 388
  - mapping 388
- Group Selected Tracks command 105
- groups
  - and automation editing 470
  - and hidden tracks 94
  - and pan 535
  - and selecting tracks 105
  - changing members 105
  - creating 105
  - deleting 106
  - Edit Group 105
  - enabling 107
  - keyboard selection 107
  - linking Mix and Edit Groups 106
  - Mix Group 105
  - renaming 106
  - unlinking Mix and Edit Groups 106
- Groups List 104
- Groups List Focus 30
- Groups pop-up menu 105
  - Delete Group command 105
  - Display command 105
  - New Group command 105
  - Suspend All Groups command 105

**H**

- H/W Buffer Size 38, 143
- half-screen 242
- half-speed playback 174
- half-speed recording 174
- hard drives
  - and Compacting Audio 310
  - and QuickTime movies 577
  - recording to system volume 147
  - Round Robin Allocation 146
- hardware
  - routing to Pro Tools 71
  - updating I/O Setup after changing 75



- Hardware Buffer Size 38
- hardware I/O inserts 433
- hardware I/O sends 415
- Hardware Setup 41
  - Analog In 42
  - Analog Out 42
  - Clock Source 42
  - Digital Format 42
  - Ext. Clock Output 42
  - initializing Legacy I/O 43
  - Input Channel Selector 42
  - Meters pop-up menu for 96 I/O 42
  - Output Channel Selector 42
  - selecting multiple outputs 44
- Hardware Setup dialog
  - Buffer Size 143
- HD Accel
  - systems 5
- HD Core card 5
- HD Process card 5
- HD systems
  - TrackPunch 195
- HD-series systems 5
- Heal Separation command 264
- hidden tracks
  - and group edits 94
  - and groups 94
  - and selections 246
- hiding
  - all tracks 94
  - auto-created regions 312
  - tracks 94
- Highest Priority Playback option 577
- Horizontal Zoom buttons 226

**I**

- I/O capacity
  - allocating 609
  - and DSP usage 609
- I/O Labels (see I/O Setup)
- I/O Settings 82
- I/O Settings files
  - import and export 81
- I/O Setup 67, 70
  - and surround sessions 508
  - default settings 80
  - displaying unavailable I/O 80
  - factory settings files 82
  - import and export settings 81
  - importing for surround 510
  - initializing 77
  - last used 81
  - reset paths 75
  - settings files 80
  - Stereo Mix preset 82
  - surround mix examples 521
  - surround mix settings file 82
- I/O View 88, 409
- Identify Beat command 318, 319
- Identify Sync Point command 265, 572
- Ignore Track Arming preference 65
- Import Audio dialog 112
- Import Audio From Current Movie command 585
- Import Audio to Track command 111
- Import MIDI command 126
- Import MIDI to Track command 125
- Import Movie command 578
  - Import Movie dialog 578
- Import Session Data command 114
- Import Session Data dialog 116
- Import Settings button 81
- importing
  - and converting audio 110
  - audio 109
  - audio and Conversion Quality 111
  - audio from QuickTime movies 585
  - MIDI tracks 125
  - multichannel I/O Settings 510
  - Pre settings 121
  - QuickTime audio 584
  - QuickTime movies 578
  - tempo and meter map 121
  - tracks for other sessions 114
- In Stop Mode, Turn Off Input Button When Disarming a Track 142
- inactive
  - items 17
  - making inserts 436
  - making plug-ins 18
  - Master Faders and assignments 407
  - paths 78
  - paths, global 78
  - sends 418
  - track path assignments 78
  - tracks 102
- Incoming Time display 553
- Indexing
  - defined 619
- Infinite
  - Clip Indication
    - Clip Indication
    - Infinite 89
  - Peak Hold
    - Peak Hold
    - Infinite 89
- Infinite Peak Hold preference 56
- in-place auditioning 83
- Input Channel Selector 42
- input connections 14, 137
  - and digital sources 172
- Input Devices command 176
- Input Filter command 178
  - MIDI Input Filter dialog 178, 395
- input levels 137
- Input Only Monitoring option 141
- Input Quantize command 178, 385
  - Input Quantize window 178, 385
- Input Selector 88, 95
- Input Status LED 199
- Insert Position Selector 440
- Insert Silence command 309
  - and Shuffle Mode 309
  - and Slip Mode 309
- inserting
  - controller events 365
  - in MIDI Event List 396
  - meter events 321
  - MIDI notes 357
  - plug-ins during playback 439
  - plug-ins on tracks 437

- program changes 368
  - tempo events 315
- inserts 408, 433
  - as a shared bus 434
  - duplicating 439
  - for hardware I/O 433
  - for plug-ins 433
  - labeling 446
  - making inactive (and active) 436
  - mono 434
  - moving 439
  - on single tracks 434
  - post-fader on Master Faders 406, 434
  - shared within a submix 425
  - stereo 434
- Inserts View 409
- interlaced 562
- Internal mode (Clock Source option) 552
- Inverse linked panning 420
- Item 619
- Items to Copy 50

**J**

- Jam Sync 555

**K**

- Key Input
  - filters 445
- Key Input Selector 440
- Keyboard Focus 29
  - Audio Regions Focus 30, 223
  - Commands Focus 30
  - Groups List Focus 30
  - MIDI Regions Focus 30, 223
- keyboard shortcuts 444
  - for plug-ins 444
  - global key commands 29
  - numeric entry 252
  - recording 161

**L**

- labeling
  - inserts and sends 446
  - paths 73
- Last Used 81
- Latch Record Enable Buttons option 57
- Latch Solo Buttons option 57, 101
- latency for recording and monitoring 142
- LCRS path examples 511
- LE systems 9
  - capabilities 10
  - QuickPunch 193
- Legacy I/O 43
- length, for selections 250
- level faders
  - Output windows 412
  - sends 414
- level meters
  - for audio tracks 89
  - for MIDI tracks 89
- Levels of Undo option 61
- Levels of Undo preference 220
- LFE
  - enable in plug-ins 533
  - example sub-path 521
  - examples of discrete versus contribution 524
  - faders 533
  - plug-in enable 441
- LFE Enable button 441
- LFEs Follow Groups option 62
- Librarian menu 440
- Limit Pull Ups to NTSC/PAL Film Standards option 57
- Limit To option 59
- linear crossfades 301
- Link Edit and Timeline Selection option 245
- Link Enable buttons 441
  - in multi-mono plug-ins 518
- Link Mix and Edit Group Enables option 57
- Link Record and Play Faders option 141
- Link Selection button 245
- linking
  - inverse panning 420
  - multi-mono plug-ins 518
  - plug-in controls 443
  - stereo panners 420
- Local Control 20, 177
- locating
  - the playback cursor 239
  - with Fast Forward/Rewind 238
  - with Location Indicators 239
- Location Indicators 238
  - locating with 239
- locations, for MIDI notes
  - dragging 360
  - quantizing 383
  - randomizing 382, 384
- Lock/Unlock Regions command 279
- locking regions 279
- Loop Playback option 256
  - and Auto Touch mode 459
- loop points 168
  - and Playback Markers 168
- Loop Record mode 149, 165
- loop recording
  - and pre/post-roll 165
  - audio 165
  - MIDI 185
    - drum machine style 185
    - multiple takes 187
- looping selections 256
- loops and reverb, delay 481
- low latency monitoring
  - Bounce to Disk 143
- Low Latency Monitoring option 143
- Lt Rt 502
- LTC (Linear Time Code) 542

**M**

- Machine Chases Memory Location option 65, 566
- Machine Control 564
- Machine Control option 65
- Machine Cues Intelligently option 65
- Machine Follows Edit Insertion/Scrub option 65, 566
- Macintosh sessions
  - compatibility with Windows 131
- main paths 69
- Main Time Scale 234, 558
- Make Selected Tracks Inactive command 102
- managing regions 311
- Manual Tempo mode 28, 154

- Manually Find and Relink 130
- mapping paths in I/O Setup 76
- Markers 324
  - creating 326
  - creating on the fly 327
  - deleting 329
  - editing 328
  - extending selections to 251
  - moving 329
  - sorting 331
  - tick-based and sample-based 325
  - viewing options 330
- Master Faders
  - adding 407
  - and DSP usage 608
  - as master send level control 427
  - inactive 407
  - inserts 434
  - meters pre/post fader 407
  - multichannel 517
  - paths 412
  - post-fader inserts 406
  - signal flow 406
- Master Link button 441
  - in multi-mono plug-ins 518
- master view for tracks 210, 471
- mastering
  - digitally 493
  - to disk 492
- Matching Start Time Takes List preference 60
- matrix 501
- Mbox 9
- measures
  - partial 323
  - renumbering 323
- media 619
- Medium Priority Playback option 577
- Memory for Automation Recording option 457
- Memory Location dialog 324
- Memory Locations 324, 325
  - creating 326
  - creating on the fly 327
  - deleting 329
  - deleting all 329
  - editing 328
  - extending selections to 251
  - Markers 324
  - recalling 328
  - recalling Edit selections 170
  - renaming 328
  - Selection Memory Locations 325
  - storing Edit selections 169
- Memory Locations window
  - view filter 331
  - viewing options for Markers 330
- Merge mode (see MIDI Merge mode)
- Merge Paste command 285
- Metadata 619
- Meter
  - display 28
- meter
  - current 321
  - default 153
- meter events 321
  - editing 322
  - inserting 321
- meter map
  - importing 121
- Meter Path Selector 82
- Meter Ruler
  - displaying 321
  - extending an Edit selection to 322
- meters
  - Sends View 417
  - SurroundScope plug-in 536
- Mic Preamps View 410
- MIDI 19
  - and signal paths 20
  - audio input to Pro Tools 424
  - common misconceptions 20
  - Default Thru Instrument 177
  - patch names 367
- MIDI Beat Clock command 567
- MIDI channels 20
  - assigning 100
- MIDI clips and Regions List 221
- MIDI control surfaces 19
- MIDI controller devices 19, 175
  - Local Control 20, 177
- MIDI Device/Channel Selector 100
- MIDI devices 19
- MIDI editing
  - setting the Grid value 357
- MIDI Event List 393
  - deleting events 399
  - editing events 398
  - inserting events 396
  - navigating in 395
  - Options menu 400
  - selecting events 399
  - View Filter 394
- MIDI files (see Standard MIDI Files)
- MIDI Input Selector 99, 180
- MIDI interface 19
- MIDI Machine Control (MMC) 564
  - configuring in Pro Tools 564
  - controlling external devices with 564
  - remote track arming 566
- MIDI menu
  - All Notes Off command 372
  - Change Duration command 378
  - Change Meter command 321
  - Change Tempo command 315
  - Change Velocity command 376
  - Click Options command 151
  - Groove Quantize command 385
  - Input Devices command 176
  - Input Filter command 178
  - Input Quantize command 178, 385
  - MIDI Beat Clock command 567
  - MIDI Thru option 177
  - Quantize command 380
  - Renumber Bars command 323
  - Select Notes command 374
  - Split Notes command 375
  - Transpose command 379
- MIDI Merge mode 28, 150, 179
- MIDI Note Display option 64

- MIDI notes
  - attributes for 363
  - chasing 370
  - deleting 363
  - duplicating selected 284
  - editing 359
    - durations 378
    - pitch 360
    - velocities 361, 376
  - inserting 357
  - lengths in ticks 235
  - moving 360
  - quantizing 380, 385
  - scrolling 215
  - selecting 359, 374
  - splitting 375
  - transposing 360, 379
  - trimming start/end points 361
- MIDI offsets 371
- MIDI Operations window 373
  - parameter options 374
- MIDI Output Selector 181
- MIDI patch name files (.midnam) 367
- MIDI Preferences 64
  - Default Note On Velocity option 358
  - Global MIDI Playback Offset option 371
  - Pencil Tool Resolution When Drawing Controller Data
    - option 64, 365, 466
- MIDI recording 175
  - cancelling takes 183
  - enabling input devices 176
  - Input Filter 178
  - Merge/Replace mode 179
  - monitoring with MIDI Thru 177
  - quantizing on input 178, 385
  - System Exclusive data 188
  - undoing a take 183
  - Wait for Note 179
- MIDI regions 214
  - and controller events 217
  - and Merge Paste command 285
  - and punch recording 185
  - guidelines for editing 216
- MIDI Regions Focus 30, 223
- MIDI Regions List 220
  - and MIDI clips 221
  - dragging from 264
  - finding regions 222
  - sorting 221
- MIDI Regions List menu
  - Auto Rename Selected command 312
  - Clear Selected command 313
  - Display All command 222
  - Find command 222
  - Import MIDI command 126
  - Rename Selected command 311
  - Select Unused command 313
  - Sorting option 221
  - Time Stamp Selected command 274, 571
- MIDI Replace mode 28, 150, 179
- MIDI sound source 19
- MIDI Thru option 177
- MIDI tracks
  - and MIDI offsets 371
  - and tempo changes 317
  - assigning to multiple channels 181
  - channel strips 87
  - configuring for recording 180
  - default program change 366
  - exporting 126
  - input 99
  - loop recording 185
  - Merge Paste command 285
  - note chasing 370
  - Notes View 209, 215
  - output 100
  - punch recording 183
  - punching on the fly 184
  - recording 175
  - Regions View 209, 216
  - selecting a pitch range in 374
  - Sysex view 369
  - Velocity view 361
- Minimum Sync Delay option 566
- Minutes:Seconds Time Scale 233
- missing files
  - skipping 130
- mix busses 415
- MIX Core card 6
- MIX Farm card 6
- Mix Group 105
- Mix window 21
  - Pro Tools 6.0 22
  - track controls 21
  - track width 102
- Mix Window Follows Bank Selection option 54
- Mix Window Shows option 21
- mixed file types 50, 110
- mixer channels 14
- Mixer plug-ins
  - Pro Tools|24 MIX Systems 606
  - Pro Tools|24 Systems 606
  - Pro Tools|HD Systems 606
- mixing 497
  - and Delay Compensation 590
  - surround formats 498
- mixing and DSP usage 598
- mixing down to stereo 492
- MIX-series systems 6
- MMC (see MIDI Machine Control)
- monitoring
  - during punch recording 164
  - MIDI recording with MIDI Thru 177
  - status LED 199
- monitoring latency 142
- monitoring modes 140
  - Auto Input Monitoring 140
  - Input Only Monitoring 141
- mono
  - Bounce to Disk 488
  - format 498
  - inserts 434
  - paths 73
- mono in/stereo out 434
- Movie
  - sync offset 580
- Movie menu
  - Bounce to Movie command 586
  - Bounce to QuickTime Movie command 586
  - Highest Priority Playback option 577

- Import Audio From Current Movie command 585
  - Import Movie command 578
  - Medium Priority Playback option 577
  - Normal Priority Playback option 577
  - Set Movie Sync Offset command 582
  - Show Movie Window command 581
  - Movie Tracks 578
    - scrubbing 580
    - setting sync point 582
  - Movie window 581
  - moving
    - Bar|Beat Markers 320
    - Markers 329
    - MIDI notes 360
    - program changes 368
    - sysex events 369
  - moving inserts 439
  - MP3 file format 486
  - MPEG-1 Layer 3 486
  - MTC (MIDI Time Code) 541
    - outputting 555
  - multichannel plug-ins 434, 518
  - multichannel regions 208
  - multichannel tracks 157
    - and automation 469
    - dragging regions to 286
    - names for 145
    - replacing regions in 293
    - signal routing 513
    - splitting 286
  - multi-mono
    - plug-in Channel Selector 518
    - plug-ins 434, 518
  - Multiple mono 488
  - multiple outputs
    - Hardware Setup 44
  - multiple tracks
    - and Beat Detective 345
    - audition takes 167
    - editing across 283
    - extending selections to 252, 253
    - fitting audio regions to Edit selection 294
    - nudging regions in 277
    - pasting to 283
    - selecting 252
    - separating regions on 262
    - shuffling regions on 272
  - MultiShell 608
  - multi-timbral 20
  - Mute Audio Inputs in Auto Input 203
  - Mute automation 468
  - Mute button 101
  - Mute Frees Assigned Voice option 101, 102
  - Mute/Unmute Region command 280
  - Mutes Follow Groups option 62
  - Mutes Follow Mix Groups option 100
  - muting
    - regions 280
    - tracks 101
- N**
- Narrow Mix Window option 102
  - network connections 613
  - New Group command 105
  - New Memory Location dialog 170
  - New Session command 45
    - and last used 81
  - New Track command 157, 180
    - New Track dialog 157
  - No Auto-Scrolling option 241
  - no Clip Indication 89
  - No Output
    - by deleting paths 75
  - No Output option 413
  - no Peak Hold 89
  - No Peak Hold preference 56
  - non-contiguous selections 248
  - nondestructive editing 207
    - for audio 214
    - for MIDI 217
  - Nondestructive Record mode 148
  - nondestructive recording 161
    - recording to a new playlist 163
    - with QuickPunch 191
  - nonlinear 11
  - Normal Priority Playback option 577
  - Note Chasing option 370
  - notes (see MIDI notes)
  - Notes View 209, 215
    - MIDI tracks 215
    - mini-keyboard 215
    - scrolling up or down 215
  - NTSC
    - speed 545
  - Nudge value 276
    - trimming regions by 271
  - nudging 276
    - by next Nudge Value 277
    - multiple regions 277
    - region contents 278
    - selection range 250
    - selection start/end points 250
    - selections and regions 277
    - setting the Nudge value 276
  - Number of Voices 38
  - numeric entry
    - shortcuts 252
  - Numeric Keypad modes 31, 58
    - Classic 31
    - Shuttle 33, 244
    - Transport 32
- O**
- Object Grabber 248
    - and Edit Groups 249
  - Object selections 248
  - offline regions 208
  - offset (movie sync) 580
  - OMFI format 123
  - On Stop 474
  - Online button 25
  - Online option 59, 562
  - online recording 563
  - on-the-fly punch recording
    - MIDI tracks 184
    - QuickPunch 149, 191
  - Open Ended Record Allocation option 59, 147
  - Open Session command 47
  - opening multiple plug-in windows 441

- Operation Preferences 56
  - Audio During Fast Forward/Rewind option 238
  - Auto Regions Fade In/Out Length option 305
  - Edit Insertion Follows Scrub/Shuttle option 242
  - Link Record and Play Faders option 141
  - Machine Chases Memory Location option 566
  - Machine Follows Edit Insertion/Scrub option 566
  - Open Ended Record Allocation option 147
  - Record Online option 563
  - Use F11 for Wait for Note 179
- Operation/Destination Track pop-up menus 118
- Operations menu
  - Auto Input Monitoring option 140
  - Auto-Spot Regions command 569
  - Calibration Mode command 138
  - Copy Edit Selection to Timeline command 258
  - Copy Timeline Selection to Edit command 258
  - Destructive Record mode 162
  - Input Only Monitoring option 141
  - Link Edit and Timeline Selection option 245
  - Loop Playback option 256
  - Loop Record mode 165
  - Low Latency Monitoring option 143
  - Mute Frees Assigned Voice option 101, 102
  - Online option 562
  - Play Edit Selection command 258
  - Play Timeline Selection command 258
  - Pre/Post Roll Playback command 171
  - Pre/Post-Fader Metering option 89
  - Pre-Fader Metering 89
  - Scroll Options 241
- Optical
  - ADAT I/O 42
- Optical (S/PDIF)
  - Hardware Setup 42
- Original Time Stamp 274, 570
- Output Channel Selector 42
- Output Options
  - Conversion Quality option 490
  - Sample Rate 489
- Output Selector 88, 96
- Output windows 412
- outputs
  - default 5.1 paths and sub-paths 509
  - format and tracks 515
  - to multichannel paths 516
- overlap crossfades 301
- overlapping paths 77
- P**
- Page Scroll During Playback option 238, 241
- Pan automation 468
- Pan Indicator 88
- Pan Slider 88
- panning
  - 3-knob 532
  - and groups 535
  - automation and groups 470
  - fine-adjust mode 531
  - grids 525
  - guidelines 520
  - linked stereo 420
  - multichannel automation playlists 535
  - take over in grid 531
  - trajectory 533
  - X/Y mode 530
- parallel mixing 516
- partial measures 323
- pass-through point 454
- Paste command 282
- pasting
  - automation 472
  - between automation playlists 281
  - multiple data types 283
  - selections and regions 282
  - to multiple tracks 283
  - with Merge Paste command (MIDI) 285
  - with Repeat Paste To Fill Selection command 293
- paths
  - active and inactive 78
  - applying 77
  - arranging 74
  - audition 82
  - creating and editing 73
  - creating multichannel 510
  - default mono and stereo 73
  - default order 84
  - default output 84
  - deleting 75
  - for surround 519
  - last used 81
  - main 69
  - mapping 76
  - mono versus stereo 73
  - multichannel example 76
  - naming 73
  - overlapping 77
  - reset using Default 75
  - selecting 74
  - Stereo Mix preset 82
  - sub-path surround examples 521
- PCI Bus Activity 457
- Peak Hold
  - 3 Second 89
  - None 89
- Peak Hold option 56
- Peak Indicator 88
- Pencil tool 287, 355
  - as Eraser 364
  - drawing automation with 465
  - editing breakpoints with 467
  - Freehand 355
  - inserting MIDI notes with 357
  - Line 356
  - Random 356
  - repairing waveforms with 287
  - resolution for inserted controller events 365
  - selecting the Pencil tool shape 355
  - shapes 355, 465
  - Square 356
  - Triangle 356
- Pencil Tool Resolution When Drawing Controller Data option
  - 64, 365, 466
- Performance Volume
  - defined 620
  - Playback 620
  - Record 620
- phase 589
- Phase Invert button 441
- pitch, for MIDI notes

- transposing 360
  - transposing with Transpose command 379
- Play button 25
- Play DV Movie Out FireWire Port 579
- Play Edit Selection command 258
- Play MIDI Notes When Editing option 64
- Play Timeline Selection command 258
- playback cursor 237
  - locating 239
- Playback Cursor Locator 239
- Playback Engine 550
- Playback Markers 168, 246
  - and Edit selections 246
  - and selection length 250
  - and Timeline selections 257
- Playhead 241
  - and Edit selections 258
  - and Timeline selections 258
  - moving to region boundaries 259
- playing
  - and on-the-fly selections 248
  - at half-speed 174
  - Edit selections with Playhead enabled 258
  - from a track point 237
  - selections 255
  - Timeline selections with Playhead enabled 258
  - tracks 237
- Playlist Selector 13
- playlists 13, 217
  - adding new 218
  - and multichannel tracks 469
  - and nondestructive MIDI editing 217
  - assigning 218
  - automation playlists 217, 452, 458
  - auto-naming 218
  - deleting 219
  - duplicating 218
  - edit playlists 217
  - recalling 218
  - recording to new 163
  - renaming 218
  - setting pre/post-roll in 171
- plug-in controls
  - adjusting 444
- plug-in controls, linking 443
- plug-in inserts 433
- Plug-In Selector
  - for real-time plug-ins 440
- Plug-In Settings menu 440
- plug-in window
  - closing multiple windows 442
- plug-in window
  - opening multiple windows 441
- plug-ins
  - automating 461
  - bypassing from window 443
  - making inactive (and active) 18
- plug-ins
  - and pull rates 562
  - and surround mixing 517
  - automation accuracy in bounce 490
  - Channel Selector for multi-mono 518
  - enabling automation 444
  - for surround 518
  - inserting during playback 439
  - inserting on tracks 437
  - inserting on-the-fly 439
  - linking 518
  - linking and unlinking 443
  - mixers 607
  - mono-to-stereo 434
  - multichannel 434
  - multi-mono 434, 518
  - removing from tracks 437
- positional reference 541
- post crossfades 296, 303
- Post-Roll button 26
- pre crossfades 296, 303
- PRE settings
  - importing 121
- Pre/Post Roll Playback command 171
- Pre/Post-Fader inserts 434
- Pre/Post-Fader Metering option 89
- pre/post-roll
  - and loop recording 165
  - and punch recording 164
  - auditioning 255
  - setting 170
- Pre/Post-Roll Flags 171, 246
- Pre-Fader Metering 89
- Preferences
  - AudioSuite Dither
    - Bit Depth option 63
  - general 618
  - Mac OS X User 623
  - Mute Audio Inputs in Auto Input 203
  - TrackInput 142
  - TrackPunch 196
  - Zoom Toggle Track Height 230
- Preferences command 54
- Pre-Process using Standard Conform 348
- Pre-Roll button 26
- Pro Tools guides 3
- Pro Tools Inputs 176
- Pro Tools LE
  - file management 129
  - systems 9
- Pro Tools LE systems
  - capabilities 10
- Pro Tools session file icon 12
- Pro Tools TDM systems
  - file management 129
  - QuickPunch 192
  - TrackPunch 194
- Pro Tools|24 MIX-series systems 6
- Pro Tools|HD Accel systems 5
- Pro Tools|HD systems 5
- processing bandwidth 457
- Processing Preferences 63
- ProControl 432
- Program Change dialog 366
- program changes 20, 366
  - and bank select 366
  - auditioning 369
  - chasing 370
  - default, for MIDI tracks 366
  - deleting 368
  - editing 368
  - inserting 368
  - moving 368

- Progressive Scan 562
- ProLogic 498
- pull up and pull down
  - and plug-ins 562
  - and rulers 562
  - audio 559
  - video 559
- Pull Up/Down 546
  - 3:2 Pulldown 544
- Punch In Frame Offset preference 65
- Punch Out Frame Offset preference 65
- punch points 168
  - and Playback Markers 168
- punch recording
  - and monitoring 164
  - and pre/post-roll 164
  - audio 163
  - MIDI 183
  - MIDI on-the-fly 184
- Q**
- Quantize command 380
  - experimenting with 384
  - Quantize window 381
- Quantize Regions command 279
  - and Grid value 275
- Quantize window 381
  - Quantize Options 382
- quantizing
  - MIDI notes 380, 385
    - attacks vs. releases 381
  - MIDI on input 178, 385
- QuickPunch 149, 191
  - crossfades 191, 196
  - LE systems 193
  - region/take numbering 194
  - TDM systems 192
- QuickPunch Crossfade Length option 61, 191, 196
- QuickTime
  - and Avid Xpress DV 579
- QuickTime file format 484
- QuickTime file formats 584
- QuickTime movies
  - bouncing to 586
  - conforming 576, 583
  - frame length 577
  - importing 578
  - importing audio from 585
  - offset in Feet.Frames 582
  - offsetting 582
  - optimizing for playback 581
  - playback quality 577
  - requirements 577
  - setting start time 582
  - spotting 583
- Quit command (Macintosh) 53
- R**
- randomizing
  - note durations 378
  - note locations 382
- RealAudio file format 485
- real-time editing 207
- real-time plug-ins 433
- Rear Divergence 533
- Recall Original Track Selections preference 60
- Recompute Invalid Overviews option 55
- record (database) 621
- Record button 26, 148
- Record Enable button 138
- record enabling tracks 138
- record modes 148
  - and MIDI 150
    - Destructive Record mode 149
    - Loop Record mode 149
    - Nondestructive Record mode 148
    - QuickPunch 149
      - switching with Record button 148
- Record Online at Insertion/Selection preference 59
- Record Online at Time Code (or ADAT) Lock preference 59
- Record Online option 563
- Record Pause mode 161
- Record Safe mode 140
- Record Status LED 199
- recording 157
  - a mono audio track 157
  - a stereo audio track 157
  - a submix to disk 481
  - additional takes 161
  - and Delay Compensation 590
  - at half-speed 174
  - bouncing to disk 482
  - cancelling takes 160
  - destructively 162
  - from a digital source 172
  - from Record Pause mode 161
  - keyboard shortcuts 161
  - monitoring latency 142
  - multichannel tracks 157
  - multiple audio tracks 161
  - nondestructive 11
  - nondestructively 161
  - nonlinear 11
  - online 563
  - preferences for stop 196
  - status LED 199
  - status LEDs in Transport 199
  - System Exclusive data 188
  - to a new playlist 163
  - to the system volume 147
  - with a countoff 152
  - with Round Robin Allocation 146
  - with the click 151
- Red Book Audio CDs 586
- Redo command 219
- Regenerate Missing Fades 130
- region boundaries
  - extending selections to 251
  - moving edit cursor to 253
  - moving Playhead to 259
- region definitions 122, 571
- Region List Selection Follows Track Selection option 60, 221, 247
- regions 13
  - aligning to region start points 266
  - auto-created 208
  - auto-naming options 312
  - auto-spotting 569
  - capturing 261
  - clearing 281



- conforming with Beat Detective 346
- consolidating 310
- copying 282
- creating 261
- crossfading between 302
- cutting 282
- default names 144
- displaying all 222
- displaying names 212
- displaying times 212
- dragging from Regions List 264
- dragging to multichannel tracks 286
- duplicating 284
- exporting as audio files 121
- extending selections to include 251
- finding 222
- healing separations 264
- hiding auto-created 312
- inserting silence into 309
- locking 279
- managing 311
- moving in Grid mode 276
- multichannel 208
- muting 280
- nudging 277
- offline 208
- Original Time Stamp 274
- pastings 282
- placing at Edit insertion point 265
- placing in tracks 264
- quantizing 279
- removing unused 313
- renaming 311
- repeating 284
- replacing 291
- selecting 247
- selecting all in a track 247
- separating 262
- separating with Beat Detective 344
- separating with Separation Grabber 263
- shifting 278
- shuffling 272
  - on multiple tracks 272
- sliding 271
- slipping 273
- sorting 221
- spotting 273, 569
- spotting to movies 584
- sync points 265, 572
- time stamping 570
- trimming by Nudge Value 271
- trimming start/end points 268
- trimming to Edit insertion point 270
- trimming unwanted data from 263
- User Time Stamp 274
- user-defined 208, 311, 312
- whole-file audio regions 208
- Regions View 209, 216
- registration 4
- related takes 166
  - and Separate Region command 167
  - preferences for 167
- Relative Grid mode 225, 276
- Remote Mode option 65
- remote track arming 566
- Remove Sync Point command 265
- removing
  - crossfades 302
  - plug-ins from tracks 437
  - sends 415
- Rename Selected command 311
- renaming
  - auto-created regions 311
  - groups 106
  - Memory Locations 328
  - playlists 218
  - regions 311
- ReNUMBER Bars command 323
- Repeat command 284
- Repeat Paste To Fill Selection command 293
- repeating selections and regions 284
- Replace mode
- Replace Regions command 291
  - and multichannel tracks 293
  - Replace Regions dialog 291
- reset paths 75
- Restore Performance command 390
- Restore Performance window 390
- Return to Zero button 25
- Revert to Saved command 48
- Rewind
  - incrementally 238
  - locating with 238
- Rewind button 25
- Round Robin Allocation 146
- RTAS plug-ins 435
- Ruler View Shows option 233
- Rulers
  - changing display order 233
  - Conductor Rulers 232
  - displaying all 233
  - scrolling in 239
  - Timebase Rulers 232
  - zooming in 229
- rulers
  - pull up and pull down 562

## S

- S/PDIF
  - Hardware Setup 42
- safing automation 458
- sample delays (see DSP delays)
- sample rate 489
  - film speed vs. video speed 545
- Sample Rate Conversion options 117
- sample rate conversion quality 111, 489, 584
- Sample Rate setting 39, 489
- sample-based timing 235, 325
- Samples Time Scale 234
- Save Session As command 48
- Save Session command 48
- Save Session Copy In command 49, 51, 132
- saving a copy of a session 49
- saving a session 48
- saving the session file with a new name 48
- scaling note velocities 362, 377
- screen savers 613
- Scroll After Playback option 241
- Scroll Options 241

- scroll wheel
  - and MIDI track's Note display 215, 231
  - scrolling a Pro Tools window 239
  - zooming in the Edit window 231
  - zooming in the Edit windows 231
- scrolling
  - in the Ruler 239
  - Mix and Edit to tracks 240
  - Notes View up or down 215
  - Pro Tools window vertically or horizontally 239
- scrolling MIDI track's Note display 215, 231
- Scrub Trimmer 270
- Scrubber tool 242
  - in Shuttle mode 243
  - selecting with 254
- scrubbing 242
  - a single audio track 243
  - and edit cursor 242
  - Movie Tracks 580
  - on two audio tracks 243
  - playback speed and direction 243
  - resolution 243
  - with Scrub Trimmer 270
  - with the Selector 243
- SDDS 498
- Select All command 247
- Select Notes command 374
  - Select Notes window 374
- Select Unused Regions command 313
- selecting
  - a pitch range of notes 374
  - across multiple tracks 252
  - all regions in a track 247
  - all regions in all tracks 247
  - during playback 248
  - in MIDI Event List 399
  - MIDI notes 359, 374
  - non-contiguous regions 248
  - notes in a chord 375
  - on all tracks 253
  - regions 247
  - track material 246
  - with Scrubber 254
  - with Selection Indicators 251
- Selection Indicators 251
- Selection Memory Location 325
  - moving stored selection 329
- selections
  - across multiple tracks 247, 252
  - and Bounce to Disk 482
  - and Edit Groups 246
  - and hidden tracks 246
  - and Playback Markers 246
  - auditioning start and end points 255
  - changing length of 250
  - clearing 281
  - consolidating 310
  - copying 282
  - cutting 282
  - duplicating 284
  - extending 251
  - extending to the Meter Ruler 322
  - extending to the Tempo Ruler 317, 330
  - including Conductor Rulers 253
  - looping 256
  - moving to adjacent tracks 253
  - moving to the next/previous region 254
  - non-contiguous 248
  - nudging 250, 277
  - nudging start/end points 250
  - Object 248
  - on-the-fly 248
  - pasting 282
  - playing 255
  - removing a track from 253
  - repeating 284
  - shifting 278
  - storing with Memory Locations 325
- Selector tool 237
  - scrubbing with 243
  - selecting MIDI notes with 359
- Send controls 414
- Send Levels Follow Groups option 62
- Send mute 414
- Send Mutes Follow Groups option 62
- Send pan 414
- sends 414
  - adding 414
  - and multichannel mixing 517
  - Assignment View 416
  - automating 460
  - changing default setting 415
  - copying track automation to 461
  - default level 415
  - displaying controls for 417
  - for hardware I/O 415
  - for mix busses 415
  - labeling 446
  - mono or stereo 415
  - multichannel 517
  - removing 415
- Sends Default to -INF preference 57
- Sends View 409
- Sends View Shows 416
- Separate Region command 262
  - and multiple tracks 262
  - and related takes 167
- Separate Region Operates On All Related Takes option 61, 167, 262
- Separation Grabber 263
- Session Data to Import menu 118
- session files
  - concepts 12
- session parameters 50
- Session Setup window 551
  - Current TC 573
- session templates 51
- sessions 12
  - audio format 552
  - bit depth 46, 552
  - closing 53
  - creating 45
  - creating for surround mixing 508
  - default tempo 318
  - frame rate 553
  - mixed audio formats 50
  - opening 47

- sample rate 39, 46, 552
- saving 48
- start frame 553
- transfers and Delay Compensation considerations 591
- Set Movie Sync Offset 580
- Set Movie Sync Offset command 582
- setting punch/loop points 168
- Setups menu
  - Disk Allocation 145
  - Feet.Frames Time Scale 234
  - I/O Setup 70
  - Preferences command 54
- Shift command 278
- Shift dialog 278
- shortcuts for keyboard input 444
- Show Disk Names option 221
- Show File Names option 221
- Show Full Pathnames option 221
- Show Meters in Sends View option 55, 417
- Show MIDI Operations command 373
- Show Movie Window command 581
- Show Original Setup button 80
- Show System Usage 599
- Shuffle mode 224
  - and locked regions 279
  - and moving regions 271
- shuttle
  - fixed mode option 244
- Shuttle, Numeric Keypad mode 33, 58, 244
- side-chain processing 440, 445
- signal flow
  - audio tracks 404
  - Auxiliary Inputs 405
  - Master Faders 406
- signal routing
  - and default path order 84
  - basics for surround 516
  - example 15
  - surround examples 522
- Single Zoom mode 229
- Skip All 130
- sliding regions 271
- Slip mode 224
  - and moving regions 272
- Smart Tool 288
  - and audio tracks 288
  - and MIDI tracks 288
  - and multichannel tracks 289
  - creating crossfades with 288
  - creating fades with 288
  - editing automation with 289
  - editing controller events with 289
- Smooth and Thin Data After Pass option 61, 465
- smoothing automation 456
- SMPTE
  - configuration 556
  - frame formats 543
  - start frame for session 553
- SMPTE/ITU 498
- snapshot automation 475
  - adding to empty automation playlists 476
  - and trim values 477
  - writing over existing automation 476
- SND resource file format 484
- Soft Limit 43
- Solo button 101
- Solo Safe mode 101
- soling
  - tracks 101
  - tracks in a submix 427
- Solos Follow Groups option 62
- Solos Follow Mix Groups option 100
- sorting
  - Markers 331
  - regions 221
- Sorting option 221
- Sound Designer II file format 484
- Source Path 483
- speakers
  - layouts 498
  - suggested 5.1 placement 500
  - surround calibration 501
  - surround placement 500
- Split Notes command 375
  - Split Notes dialog 375
- Split Selected Tracks Into Mono command 286
- splitting stereo and multichannel tracks 286
- Spot dialog 273, 568
  - Use Subframes option 568
  - User Time Stamp button 570
- Spot mode 224, 567
  - and moving regions 273
  - trimming regions in 570
- spotting
  - auto-spotting 569
  - QuickTime movies 583
  - regions 273, 567, 569
- SRC options 117
- Standard MIDI Files 125
  - exporting 126
  - importing 125
  - Type 0 125
  - Type 1 125
- Standard Trimmer 267
- start frame, for sessions 553
- Start, End, and Length display 24, 169
- stems 69
  - surround examples 523
- stepped control automation 468
- Stereo 488
  - stereo format 498
  - stereo inserts 434
  - stereo interleaved files, exporting 122
- Stereo Mix
  - I/O Setup factory preset 82
- Stereo Mixer plug-in 607
- stereo tracks
  - dragging regions to 286
  - names for 144
  - replacing regions in 293
  - splitting 286
- Stop at Shuttle Speed Zero option 65
- Stop button 25
- Stop Disarms Audio Track Record Button 197
- Strip Silence command 307
  - and region naming 308
- Strip Silence window 307
- stuck notes 372
- sub
  - with bass management 506

- Sub Time Scale 235, 558
  - subframes 568
  - submixes
    - applying an insert to 425
    - bouncing to 491
    - bouncing to disk 481
    - soling tracks in 427
  - sub-paths 69
    - examples for surround 519
  - Support Background Record Applications preference 57
  - surround
    - and sends 517
    - basic signal routing 516
    - bass management 506
    - center percentage (%) 535
    - concepts 497
    - configuring Pro Tools and sessions 508
    - delivery formats 505
    - discrete level, solo, mute 514
    - divergence basics 503
    - encoding and decoding 505
    - example 5.1 format paths 511
    - importing I/O Settings 510
    - Lt Rt 502
    - mix compatibility 504
    - mixer specifications 606
    - mixing concepts 504
    - mixing formats 498
    - pan playlists and automation 535
    - panning grids 525
    - Pro Tools formats 498
    - settings files 508
    - speaker arrangements 498
    - terminology 501
    - using paths 519
    - using sub-paths, examples 519
  - Surround Mixer
    - plug-in features 607
    - specifications 606
  - Surround Mixer plug-in 607
  - SurroundScope 536
  - Suspend All Groups command 105
  - suspending automation 463
  - swing 382, 384
  - SYNC I/O 540, 543
    - and VSO
    - generating time code with 563
    - resolving with 549
    - sync options 550
  - Sync Mode field 552
  - Sync Offset 556
  - sync points 572
    - for QuickTime movie 582
    - for regions 265
    - from Beat Detective 349
    - identifying 265, 572
  - synchronization 539
    - 3:2 Pulldown 544
    - and film 544
    - Bi-Phase/Tach 542
    - black burst 573
    - film speed vs. video speed 545
    - guide tracks 544
    - LTC 542
    - MIDI Beat Clock 567
    - MMC 564
    - options 549
    - positional reference 541
    - Pull Up/Down 546
    - resolving 573
    - SMPTE frame formats 543
    - time code 541
    - troubleshooting 573
    - VITC 542
  - Sysex view 369
  - system
    - settings 37
    - shutting down 37
    - starting up 37
  - System Activity 457
  - System Exclusive data 20, 369
    - deleting 370
    - moving 369
    - recording 188
  - System Memory Allocation 41
  - system resources 16
  - System Usage 457
  - System Usage window 598
  - System Usage Window Shows 599
- T**
- Tab to Transients button 254
  - take over (surround pan) 531
  - Take Region Lengths That Match option 61, 167
  - Take Region Names That Match Track Names option 60, 167
  - takes
    - auditioning 166
    - auditioning from Takes List 166
    - default names 144
    - numbering for QuickPunch 194
    - recording additional 161
  - Takes List pop-up menu 166
    - and multiple tracks 167
  - tapping in the tempo 154
  - Target button 441
  - Tascam DA30 42
  - TC/E Plug-In preference 63
  - TDM Mixer plug-ins 607
    - switching 607
  - TDM plug-Ins
    - and DSP usage 608
  - TDM plug-ins 435
    - MultiShell 608
  - TDM systems 5
    - audio capabilities 7
    - audio interfaces 8
    - I/O capabilities 8
    - MIDI capabilities 7
    - QuickPunch 192
  - TDM Time Slot usage 457
  - technical support
    - suggestions 613
  - templates
    - Beat Detective 342
  - tempo
    - current 315
    - default 153, 318
    - display 28
    - effects on Markers and Memory Locations 325
    - effects on MIDI and audio 317

- Manual Tempo mode 154
- tapping in 154
- tempo events 315
  - and Bar|Beat Markers 320
  - editing 316
  - inserting 315
- tempo map
  - from Identify Beat command 318
  - importing 121
- Tempo Ruler
  - displaying 315
  - extending an Edit selection to 317, 330
- test 490
- Thin Automation command 465
- thinning automation 456, 465
- tick-based timing 235, 325
- time alignment 589
- time code 541
  - and Jam Sync 555
  - capturing 568
  - freewheeling 555
  - generating 555, 563
- Time Code Mapping options 117
- Time Code Time Scale 234
- Time Scale 233
  - Bars:Beats 233
  - Feet:Frames 234
  - Main 234, 558
  - Minutes:Seconds 233
  - Samples 234
  - Sub 235, 558
  - Time Code 234
- Time Stamp Selected command 167, 274, 571
- time stamps 570
  - and Bounce to Disk 482
- Time Trimmer 268
- TimeAdjuster
  - and Delay Compensation 591
- TimeAdjuster TDM plug-in 591
- Timebase Rulers 232
  - and selecting on all tracks 253
  - and Timeline selections 257
  - Edit Markers 246
  - Playback Markers 246
  - Pre/Post-Roll Flags 246
  - sliding Edit selections 254
  - sliding Timeline selections 258
- Timeline Insertion Follows Playback option 56
- Timeline selections 257
  - and Playback Markers 257
  - auditioning with Playhead enabled 258
  - copied from Edit selection 258
  - copied to Edit selection 258
  - in Timebase Rulers 257
  - sliding in the Ruler 258
  - start, end, and length fields 27
- To All Enabled Parameters
  - writing automation 477
- To Current Parameter
  - writing automation 477
- toggle
  - track height 211
  - Track View 210
  - zoom level 230
- Touch Timeout option 62
- track controls
  - Edit window 24
  - Mix window 24
- track data 208
- Track Height 210
  - and Zoom Toggle 230
- track layout
  - default path order 84
- track level meters 89
- Track Name/Comments dialog 91
- Track Offset options 117
- Track Selection Follows Regions List Selection option 60, 247
- Track Selector 440
- Track View 209
  - and edit content 280
  - Blocks 209
  - Expanded Track Display 211, 469
  - master view 471
  - Notes 209, 215
  - Regions 209, 216
  - Sysex 369
  - toggle 210
  - Velocity 361
  - Waveform 209, 212
- Track View Toggle 210
- track width 102
- TrackPunch
  - HD systems 195
  - preferences 196
- tracks
  - 5.1 format track layout 514
  - adding comments 92
  - adding to selection 252, 253
  - and surround 513
  - appending new material to end of 162
  - color coding 103
  - concepts 13
  - deleting 93
  - duplicating 93
  - grouping 103
  - hiding 94
  - locating with Fast Forward/Rewind 238
  - making inactive/active 102
  - master view 210, 471
  - moving selections between 253
  - muting 101
  - names 91, 144
  - placing regions in 264
  - playback priority 97
  - playing 237
  - record enabling 138
  - removing from a selection 253
  - scrolling shortcut 240
  - selecting across multiple 252
  - selecting all regions in 247
  - selecting all regions in all tracks 247
  - selecting material in 246
  - selecting on all 253
  - soling 101
  - Track Height 210
  - Track View 209
  - transposing 380
  - trimming unwanted data from 263
  - trajectory panning 533

- Transfer
  - files 130
- Transfer Volume
  - defined 623
- transients
  - detecting with Beat Detective 338
  - tabbing to 254
- Transport
  - Input LED 199
  - Record LED 199
  - record status display 199
- Transport Master 565
- Transport Master button 27
- Transport Numeric Keypad Mode 32, 58
- Transport window 25
  - MIDI controls 27
  - pre/post-roll 26, 171
  - start, end, and length fields 27, 169
  - transport controls 25
- Transport, Numeric Keypad mode 32
- Transpose command 379
  - Transpose window 379
- transposing 379
  - by octave 380
  - key 380
  - MIDI notes 360
  - tracks 380
- Trim Automation command 478
- Trim End To Insertion command 271
- Trim Start To Insertion command 270
- Trim To Selection command 263
- Trimmer tool 267
  - Scrub Trimmer 270
  - Time Trimmer 268
- trimming
  - automation breakpoints 467, 475
  - crossfades 302
  - input sum levels 605
  - note start/end points 361
  - region start/end points 268
  - regions by Nudge Value 271
  - regions to Edit insertion point 270
  - regions with Scrub Trimmer 270
  - unwanted region and track data 263
- Tweak Head setting 490

## U

- unavailable I/O
  - showing 80
- unavailable resources 47
- Undo and audio recording 160
- Undo command 219
- Undo Queue 220
- Universe window 231
- unlinked Edit and Timeline selection 245
- unlinking plug-in controls 443, 518
- Use All Available Space preference 59
- Use AudioSuite Dither preference 63, 431
- Use F11 for Wait for Note option 57, 179
- Use Squeezer option 490
- Use Subframes option 568
- User Time Stamp 274, 571
- user-defined regions 208, 311, 312

## V

- Variable Speed Override 553
- velocities, for MIDI notes
  - default for inserted 358
  - drawing with Pencil 362
  - editing 361, 376
  - editing velocity 361
  - fading 377
  - scaling 377
  - scaling with Trimmer 362
- Velocity view 361
- Vertical Zoom buttons 226
- video
  - recording limits with pull 562
- video capture/playback cards 576
- Video Media options 117
- Video Pull Up/Down 559
- video speed 545
- View Filer command 394
- views
  - Comments View 90
  - I/O View 88
  - Inserts View 409
  - Sends View 409
- Virtual Memory 613
- VITC (Vertical Interval Time Code) 542
- Voice 22
- Voice Selector 98
- voices
  - and track priority 97
  - auto-assignment of ascending 98
  - for TrackPunch 195
- Volume
  - types, definitions 620
- Volume automation 467
- Volume fader 88
- Volume Indicator 88
- VSO (see Variable Speed Override)

## W

- Wait for Note 27, 179
- WAV file format 131, 484
  - AES31/Broadcast compliant 131
- Waveform view 209, 212
- waveforms 212
  - and zero-crossing 213
  - avoiding clicks and pops 213
  - drawn rectified 213
  - guidelines for editing 213
  - repairing with Pencil tool 287
- Web site 4
  - whole-file audio regions 208
- Wide Meters View 90
- Windows menu
  - Show System Usage 599
- Windows sessions
  - compatibility with Macintosh 131
- Word Clock 42
  - about 624
- workflows 201
- Write Automation command 476, 477
- Write Switches to Touch After Pass preference 61
- Write to Start/All/End buttons 473

writing  
  automation 459  
  automation on stop 474  
  automation to start, end, or all 473  
  snapshot automation 475

## **X**

XML (Extensible Markup Language) 367

## **Z**

zero-crossing 213  
Zoom buttons 226  
Zoom Preset buttons 226, 229  
Zoom Presets 229  
Zoom presets 229  
Zoom Toggle command 230  
Zoom Toggle Track Height 230  
Zoom Toggle Track Height option 55  
Zoomer tool 226, 228  
zooming 226  
  a track area 228  
  all the way out 227  
  around a track point 228  
  continuously 226  
  default toggle height 230  
  horizontally for all tracks 226  
  in the Ruler 229  
  on a selection 227  
  recalling zoom levels 230  
  return to the previous zoom level 227  
  storing zoom levels 229  
  to make all regions visible 227  
  vertically for all audio tracks 227  
  vertically for all MIDI tracks 227  
  with a scroll wheel 231  
Zoom Toggle 230